

Center Finders

This document is part of GNU 3DLDF, a package for three-dimensional drawing.

Copyright (C) 2022 The Free Software Foundation

Created: March 2, 2022

Last updated: March 10, 2022

GNU 3DLDF is free software; you can redistribute it and/or modify it under the terms of the GNU General Public License as published by the Free Software Foundation; either version 3 of the License, or (at your option) any later version.

GNU 3DLDF is distributed in the hope that it will be useful, but WITHOUT ANY WARRANTY; without even the implied warranty of MERCHANTABILITY or FITNESS FOR A PARTICULAR PURPOSE. See the GNU General Public License for more details.

You should have received a copy of the GNU General Public License along with GNU 3DLDF; if not, write to the Free Software Foundation, Inc., 51 Franklin St, Fifth Floor, Boston, MA 02110-1301 USA

See the GNU Free Documentation License for the copying conditions that apply to this document.

See the GNU General Public License and the GNU Free Documentation License at the end of this document.

You should have received a copy of the GNU Free Documentation License along with GNU 3DLDF; if not, write to the Free Software Foundation, Inc., 51 Franklin St, Fifth Floor, Boston, MA 02110-1301 USA

Please send bug reports to Laurence.Finston@gmx.de The mailing list help-3dldf@gnu.org is available for people to ask other users for help. The mailing list info-3dldf@gnu.org is for sending announcements to users. To subscribe to these mailing lists, send an email with "subscribe (email-address)" as the subject.

The author can be contacted at:

Laurence D. Finston
c/o Free Software Foundation, Inc.
51 Franklin St, Fifth Floor
Boston, MA 02110-1301 USA
Laurence.Finston@gmx.de

Fig. 0

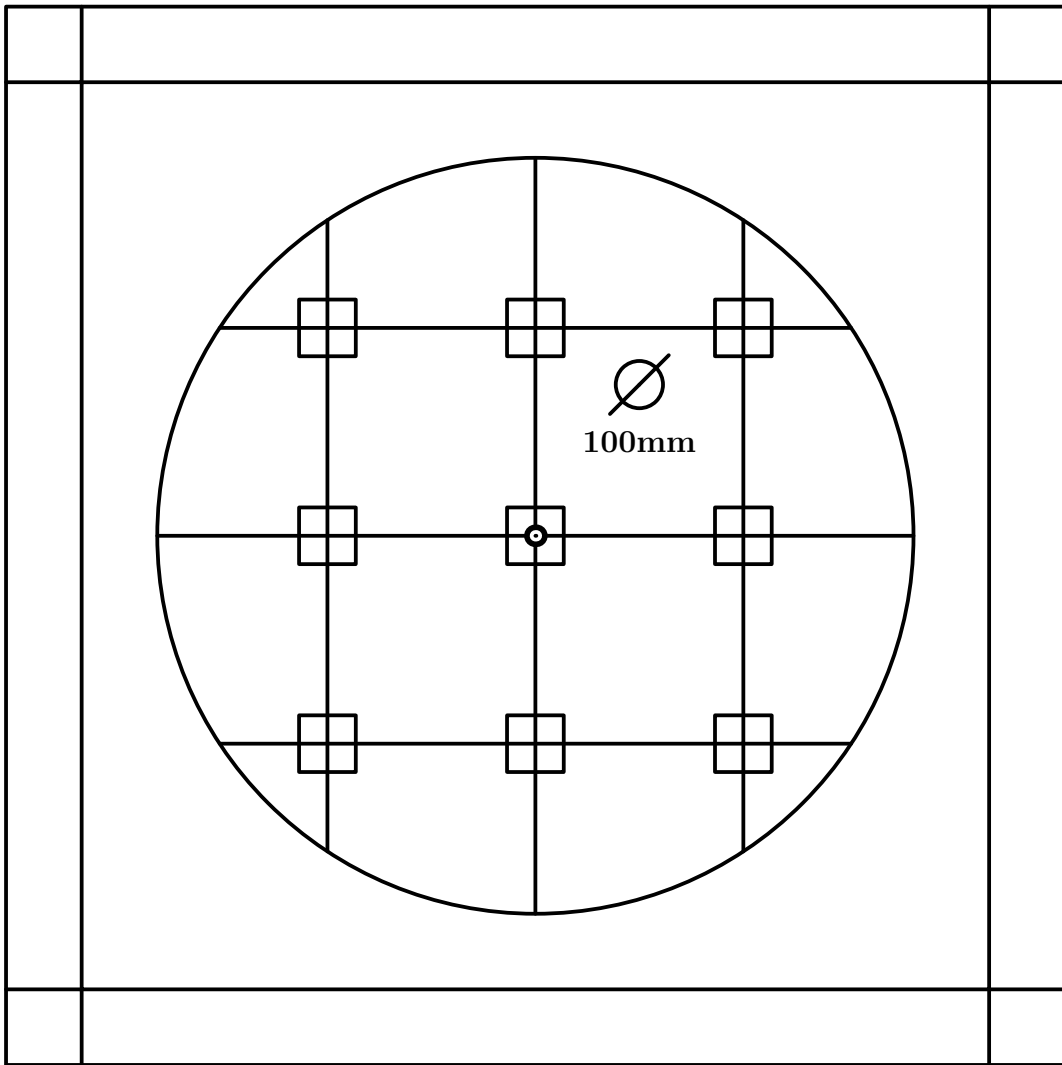

Fig. 1

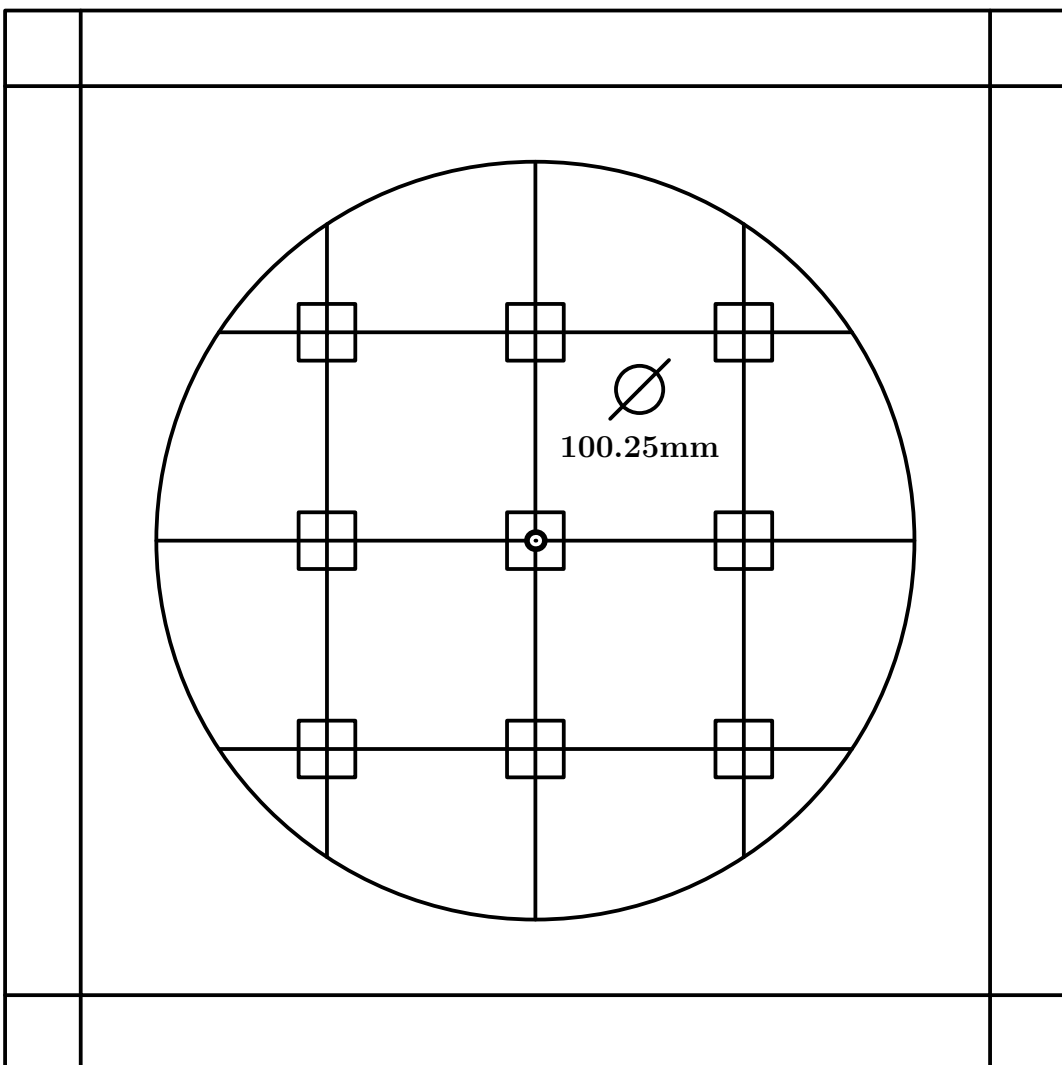

Fig. 2

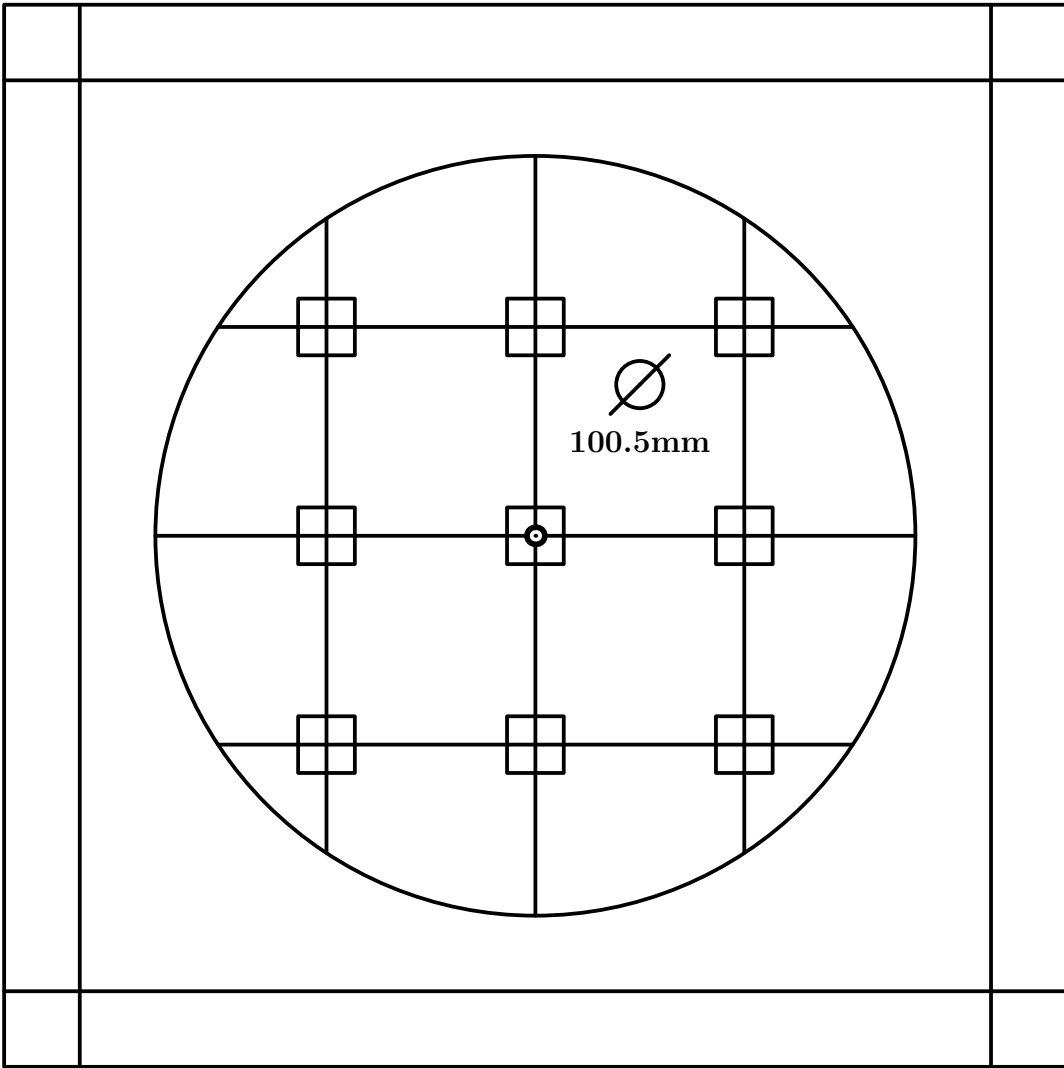

Fig. 3

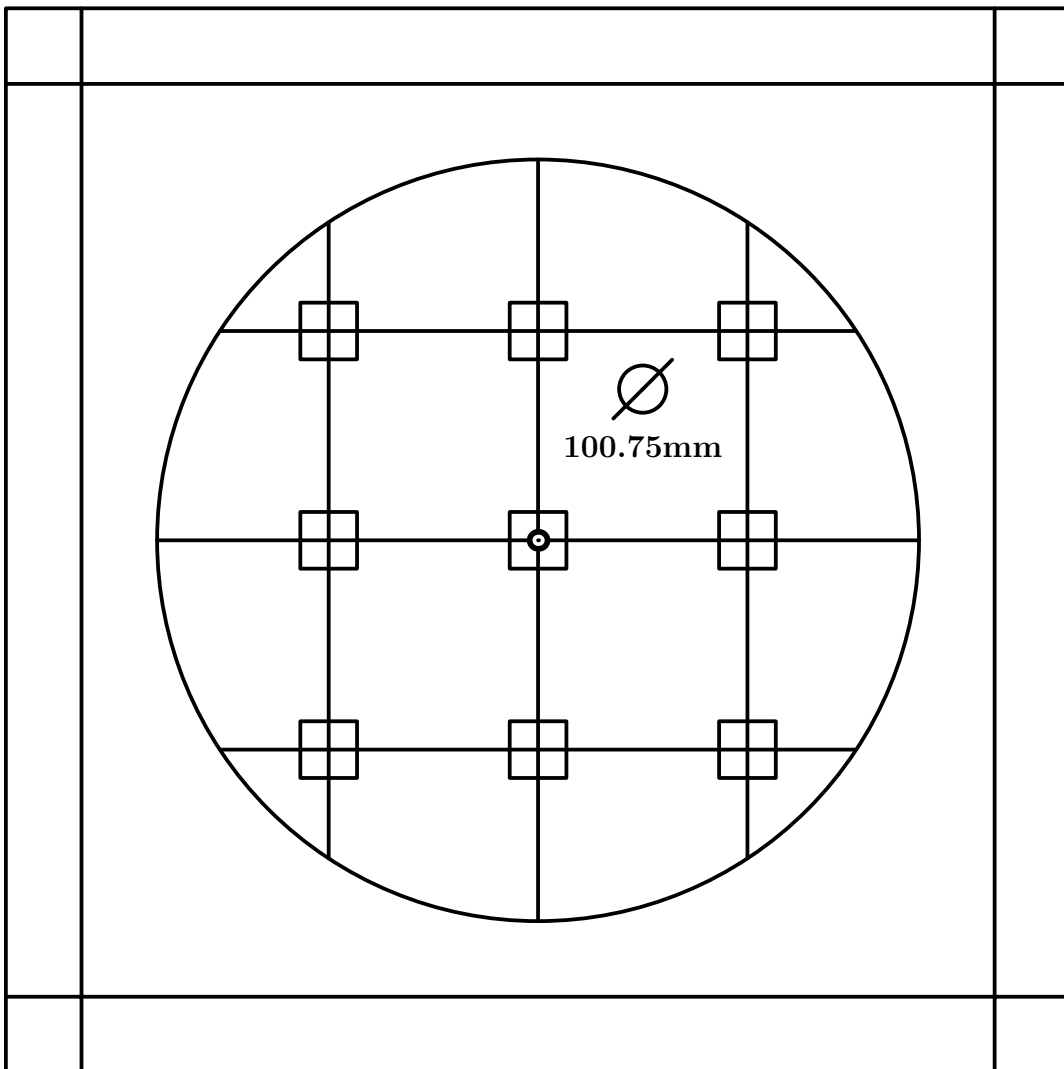

Fig. 4

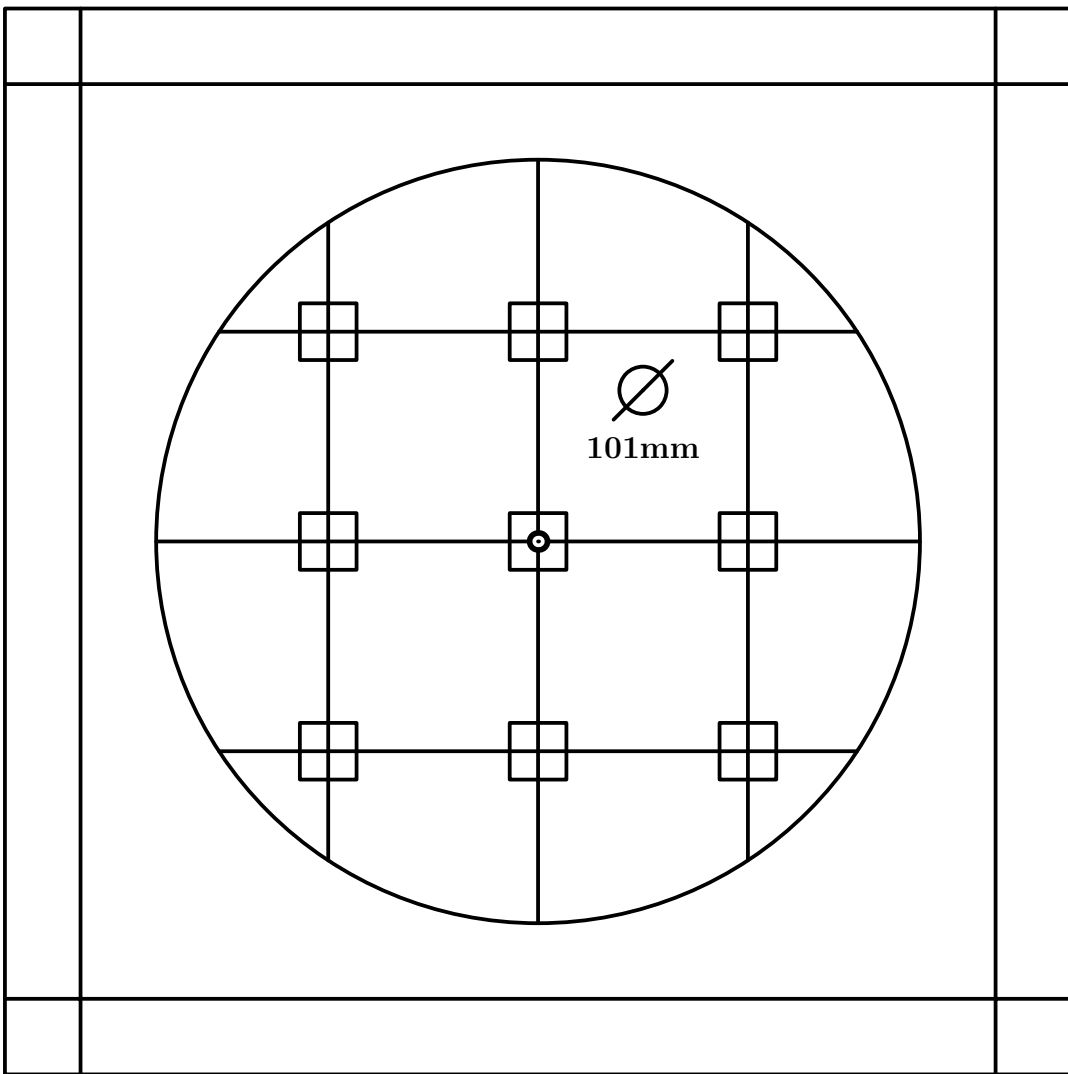

Fig. 5

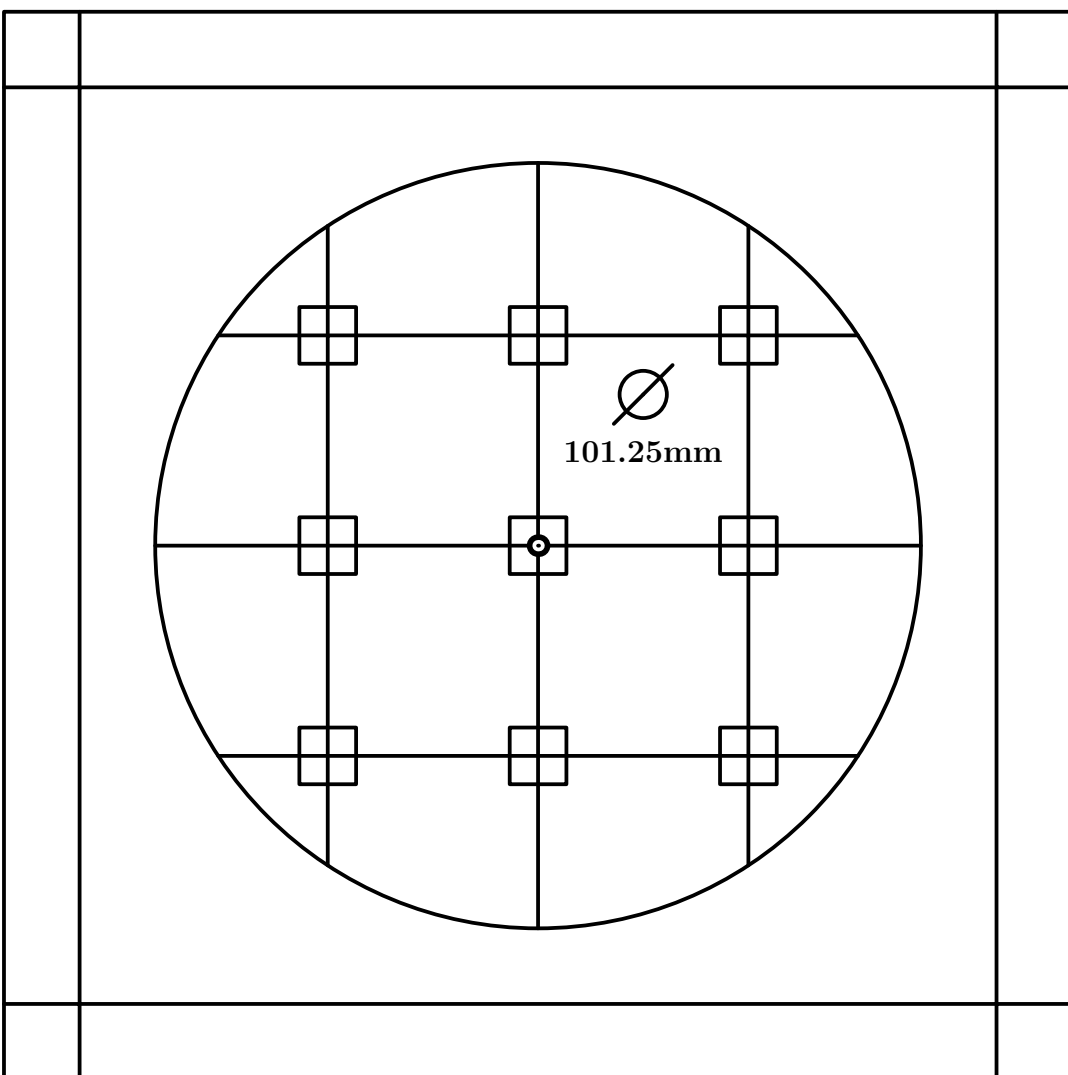

Fig. 6

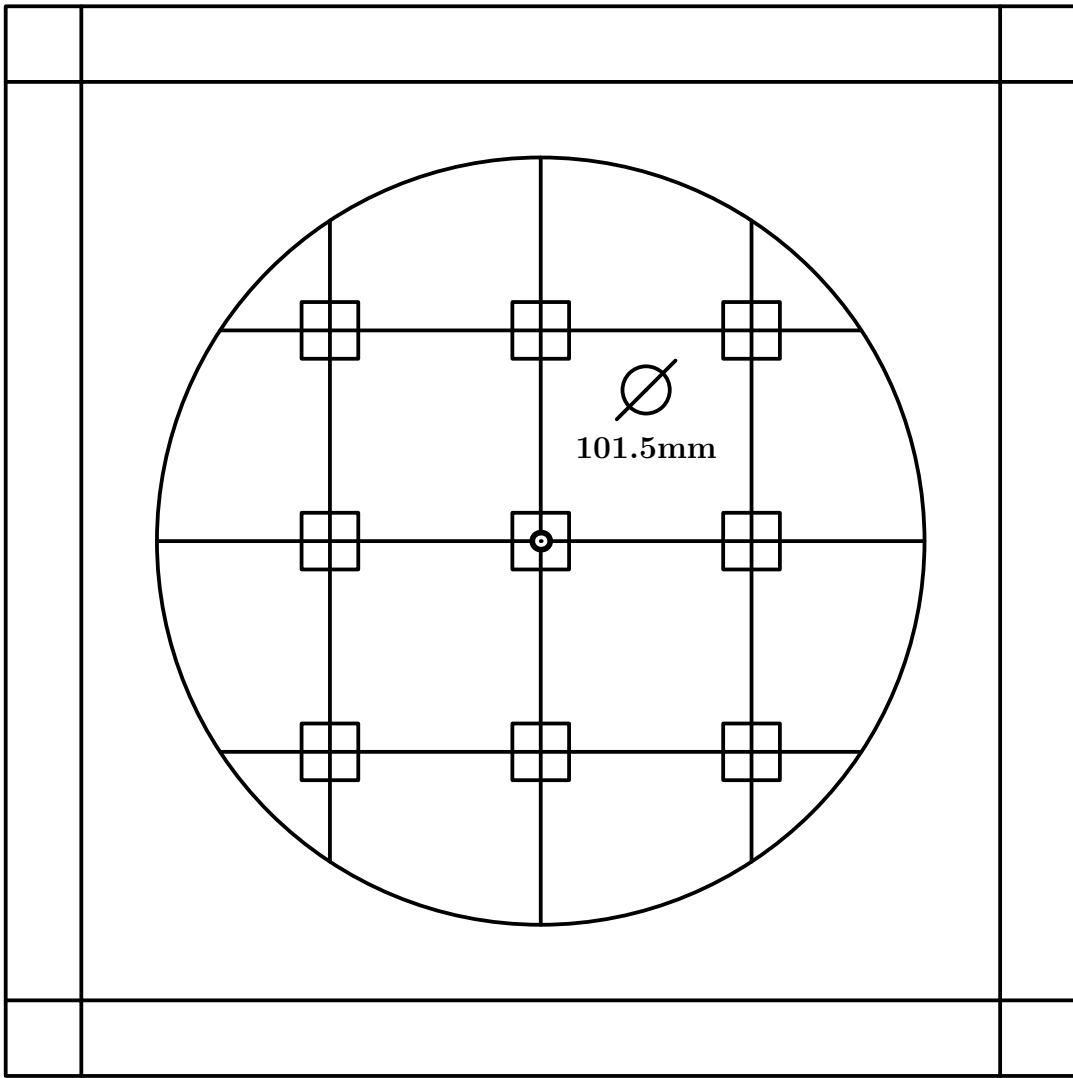

Fig. 7

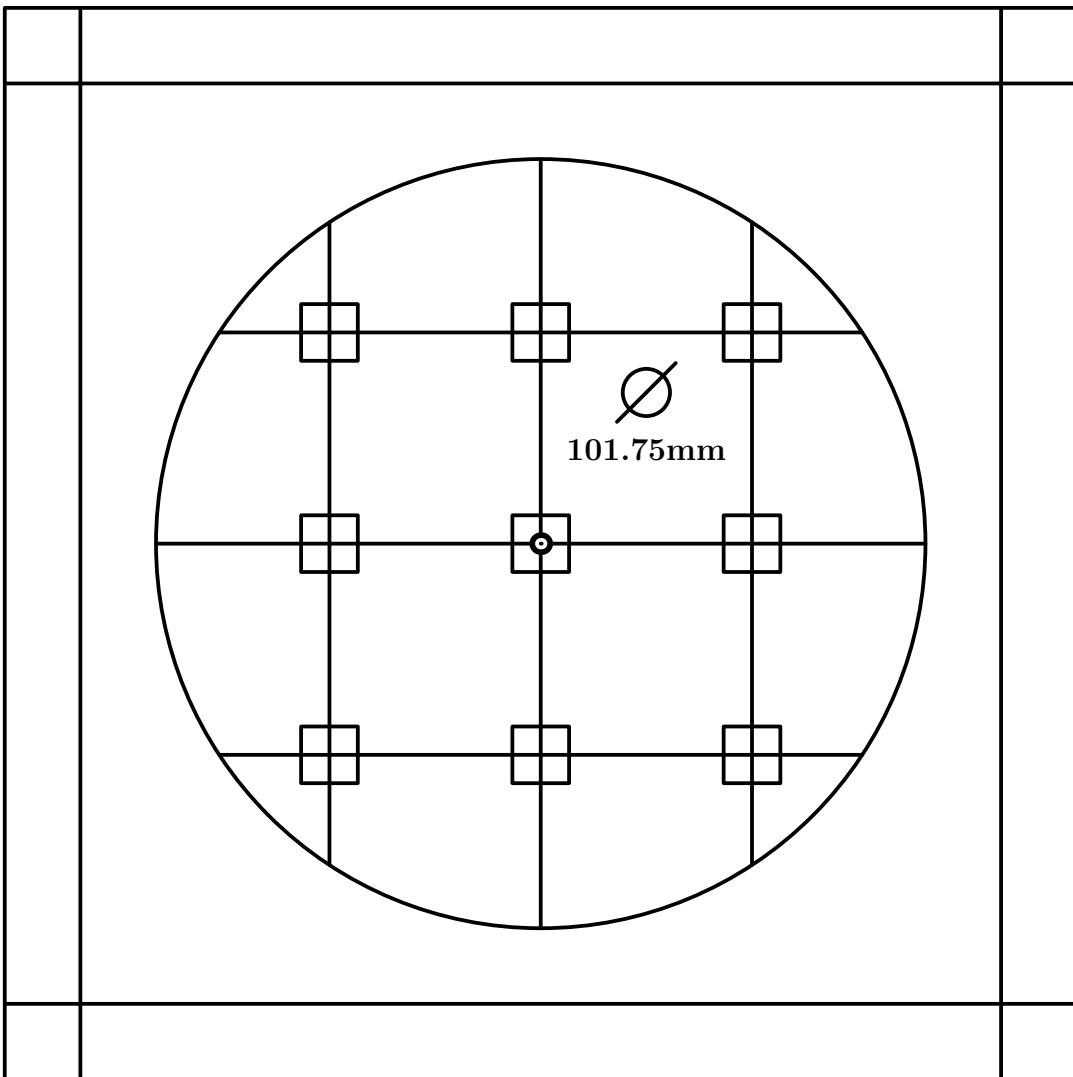

Fig. 8

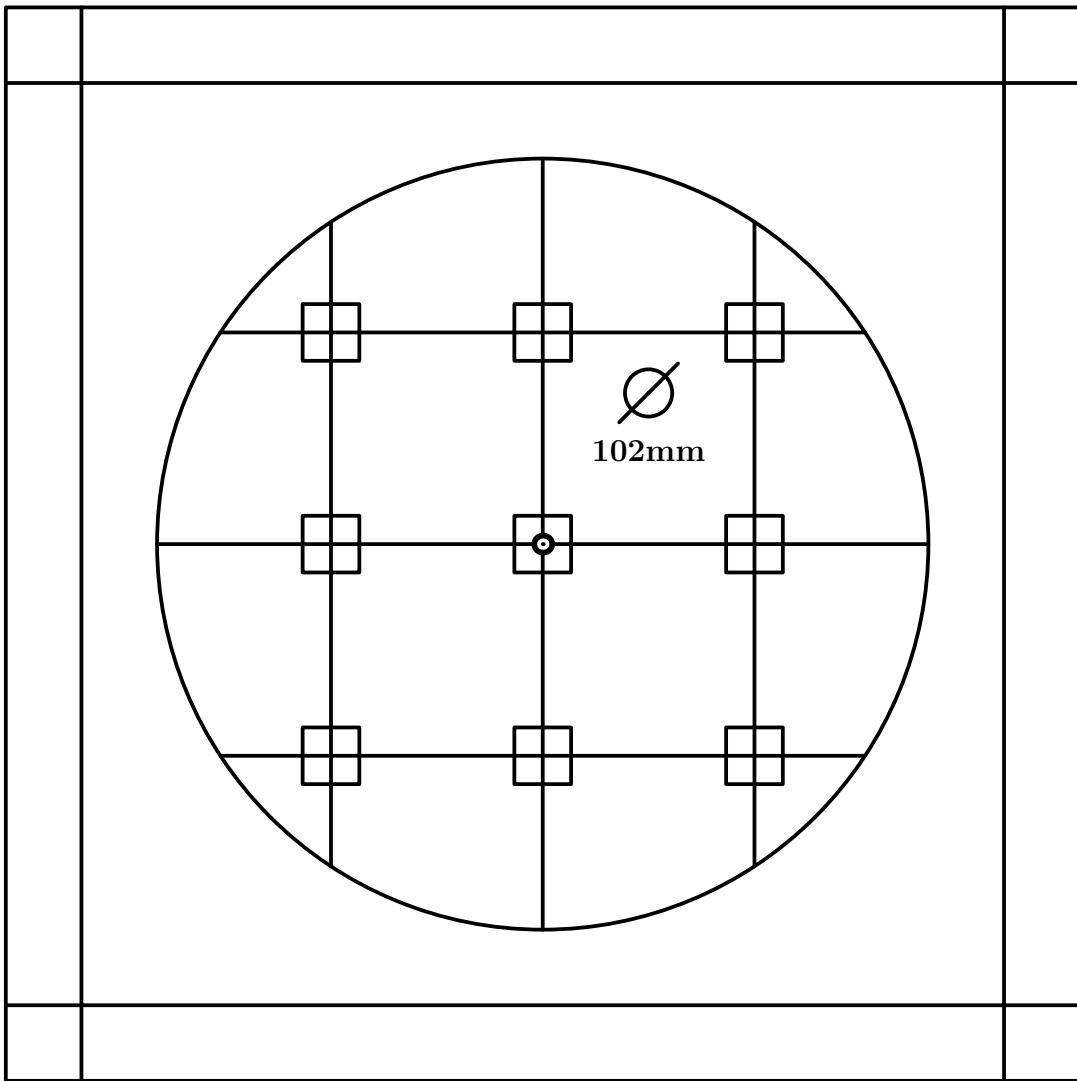

Fig. 9

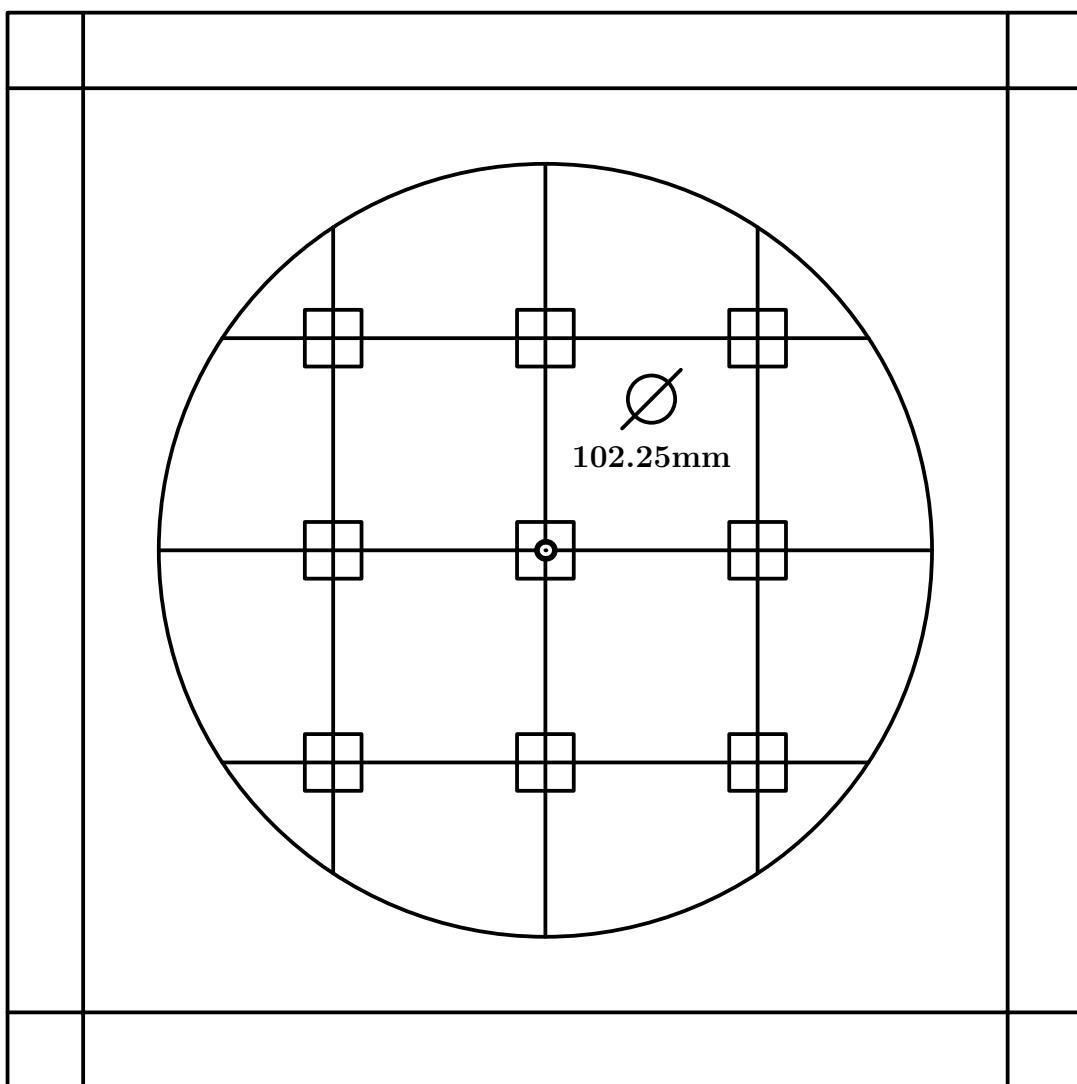

Fig. 10

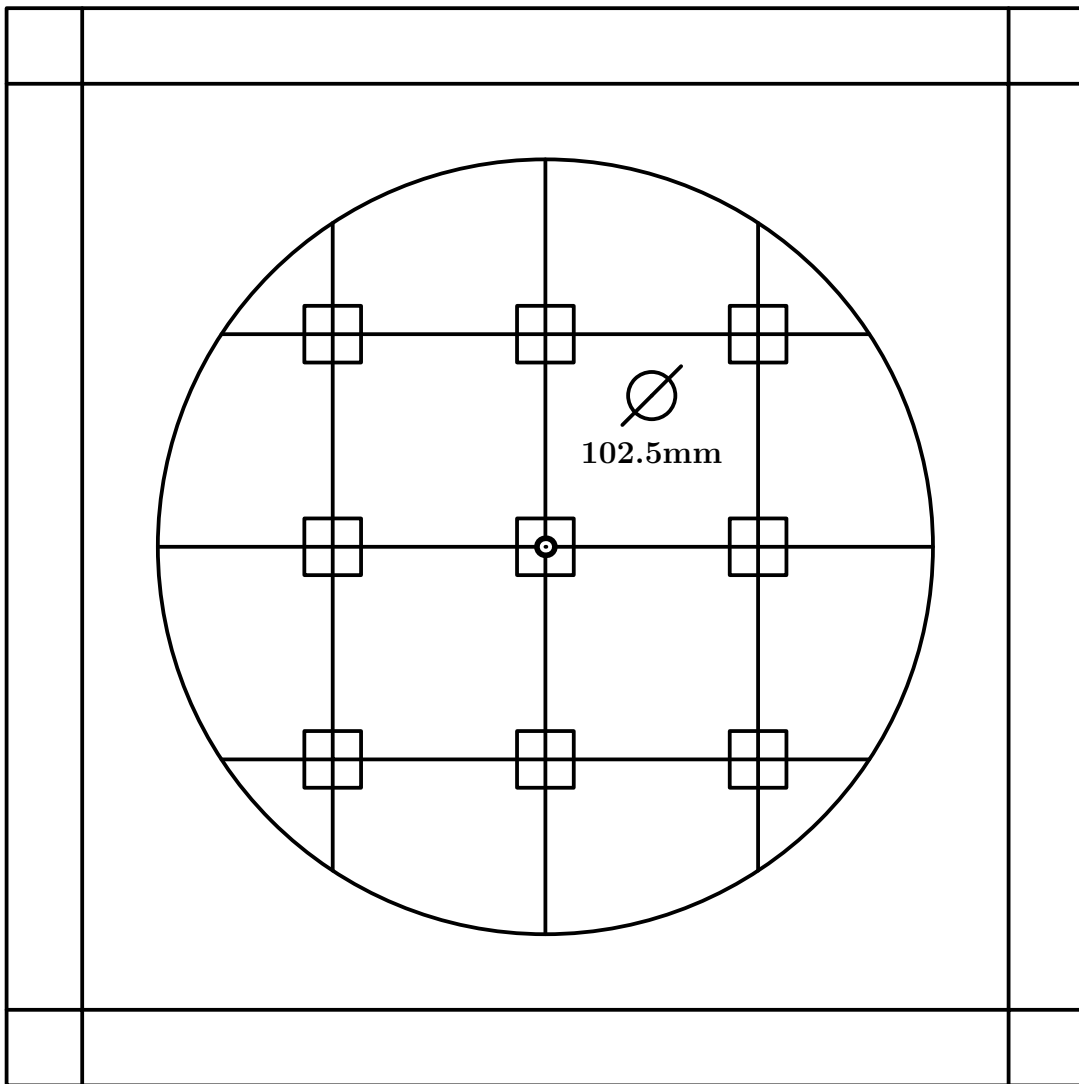

Fig. 11

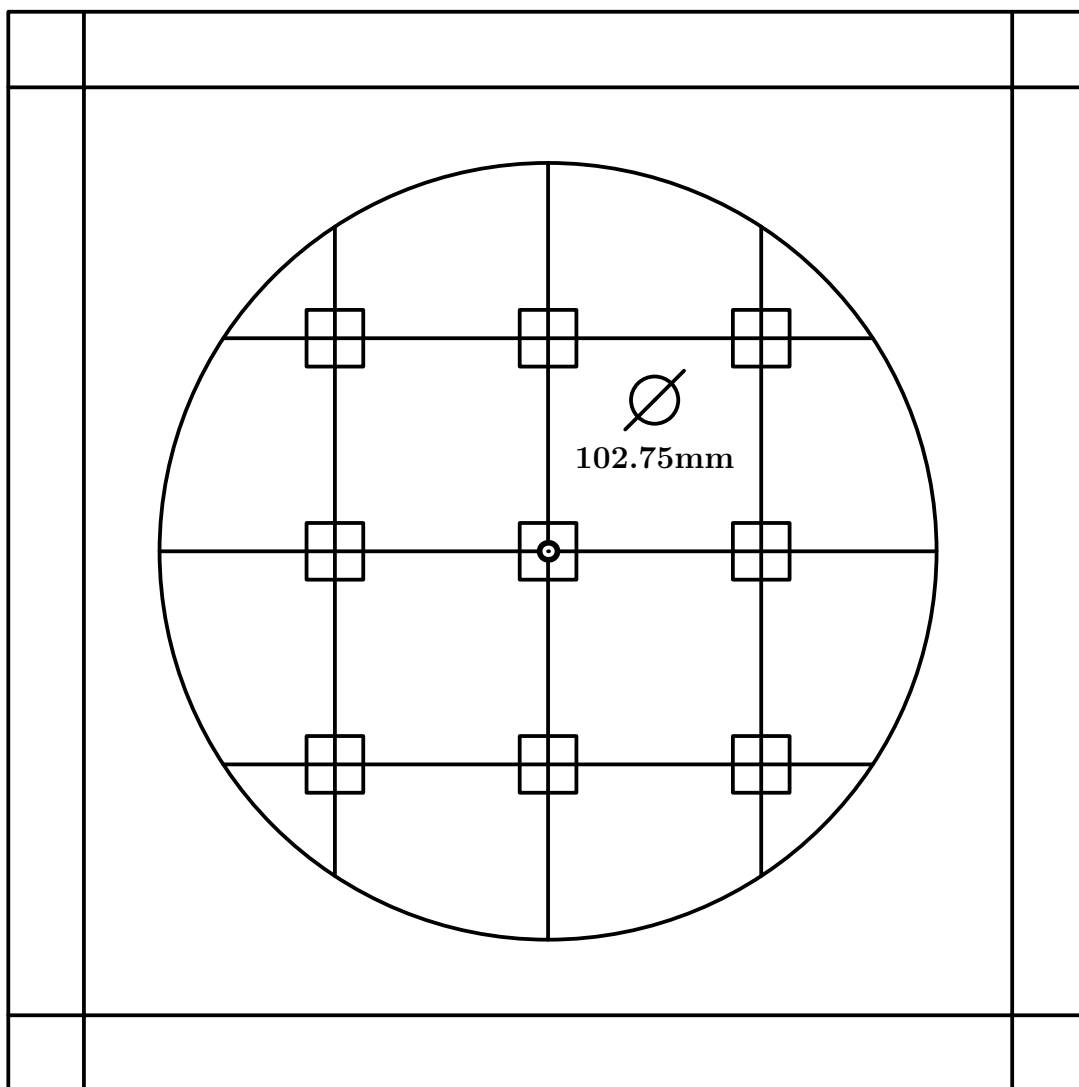

Fig. 12

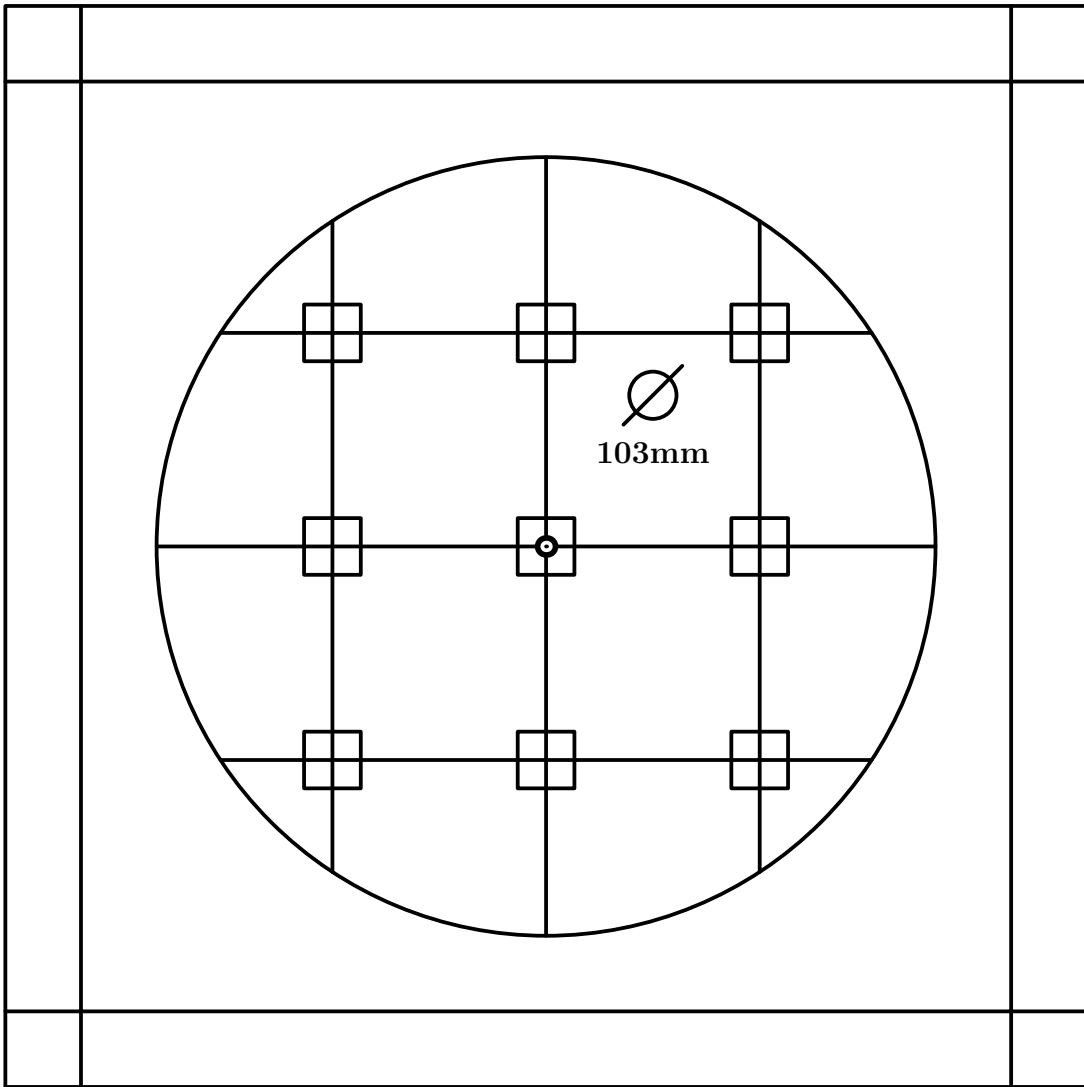

Fig. 13

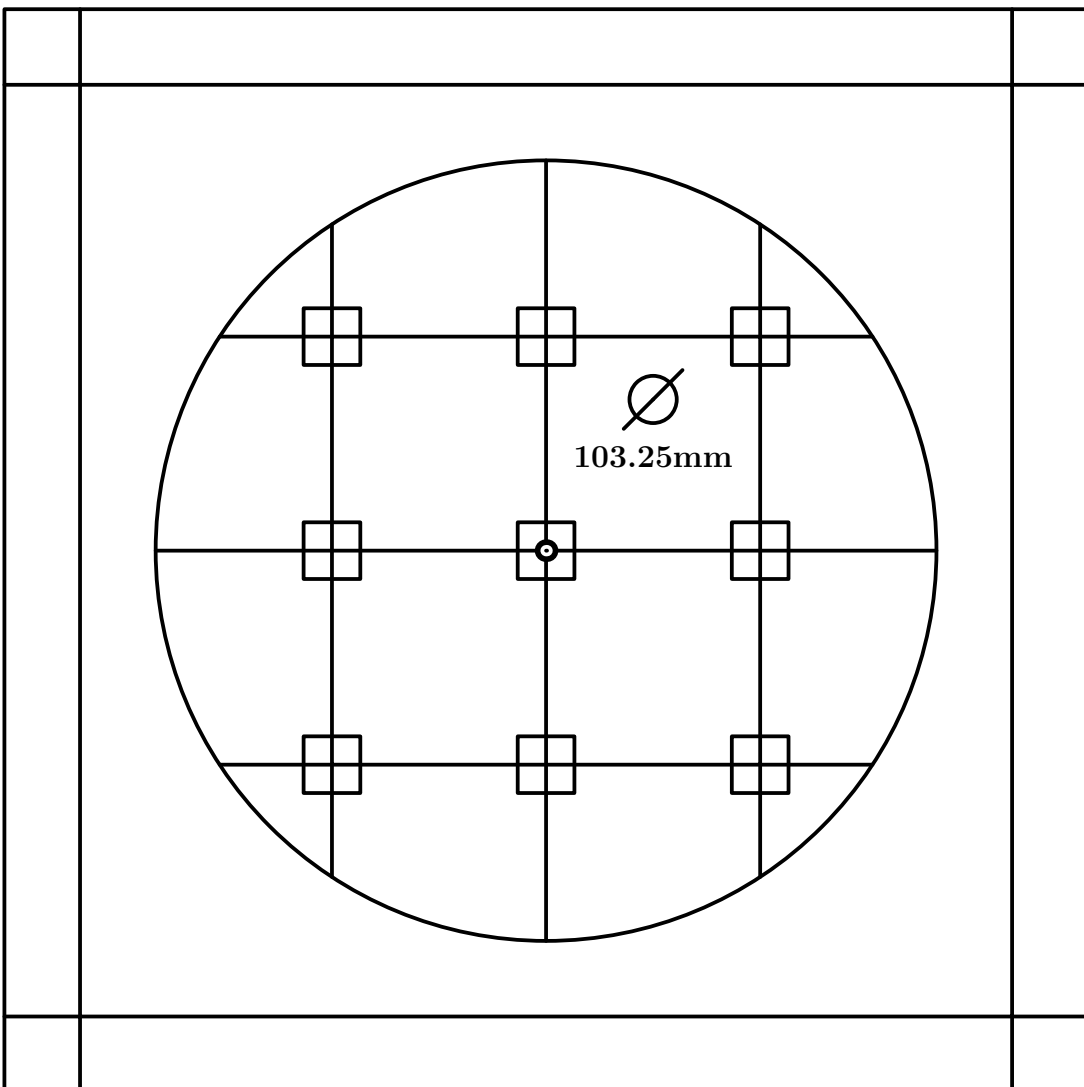

Fig. 14

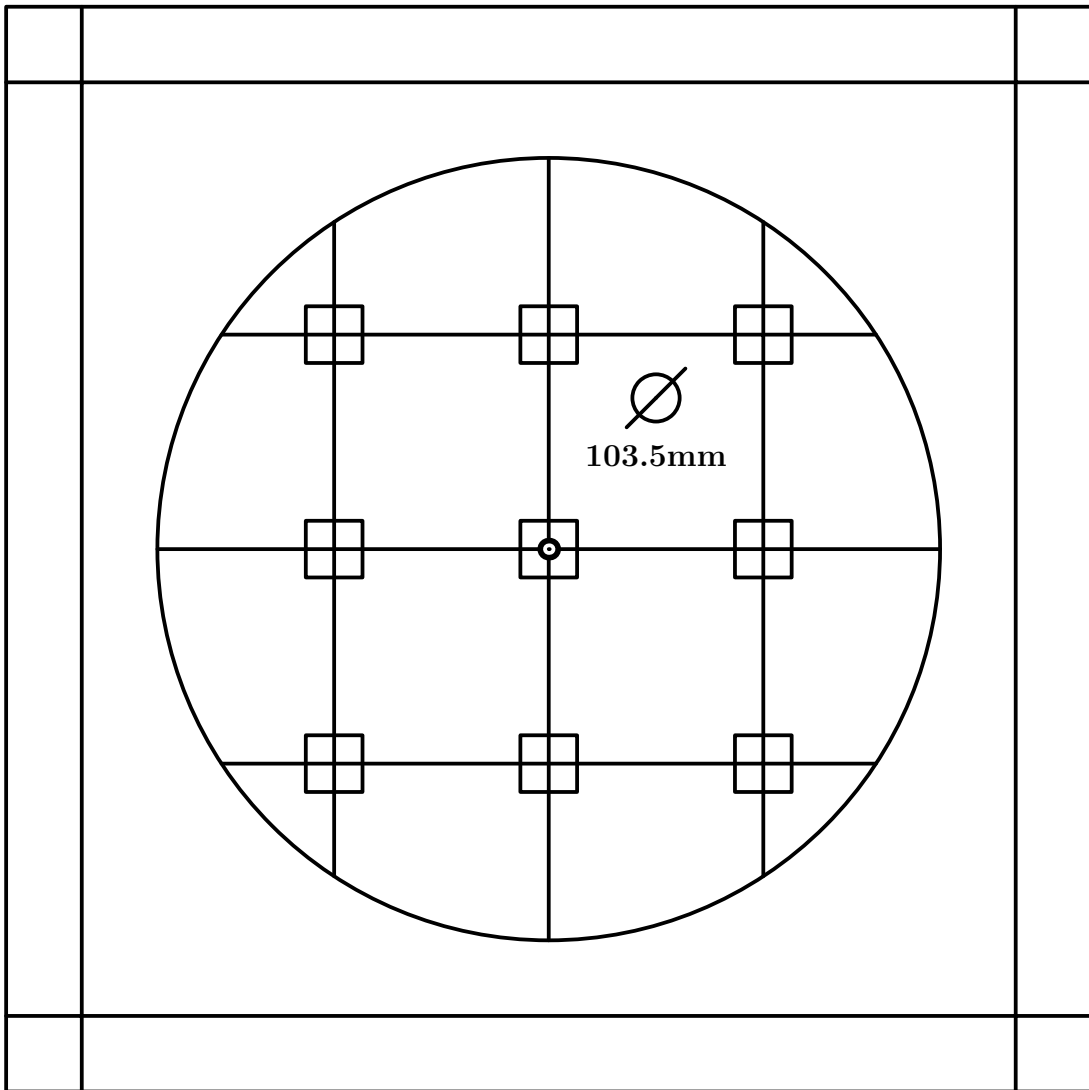

Fig. 15

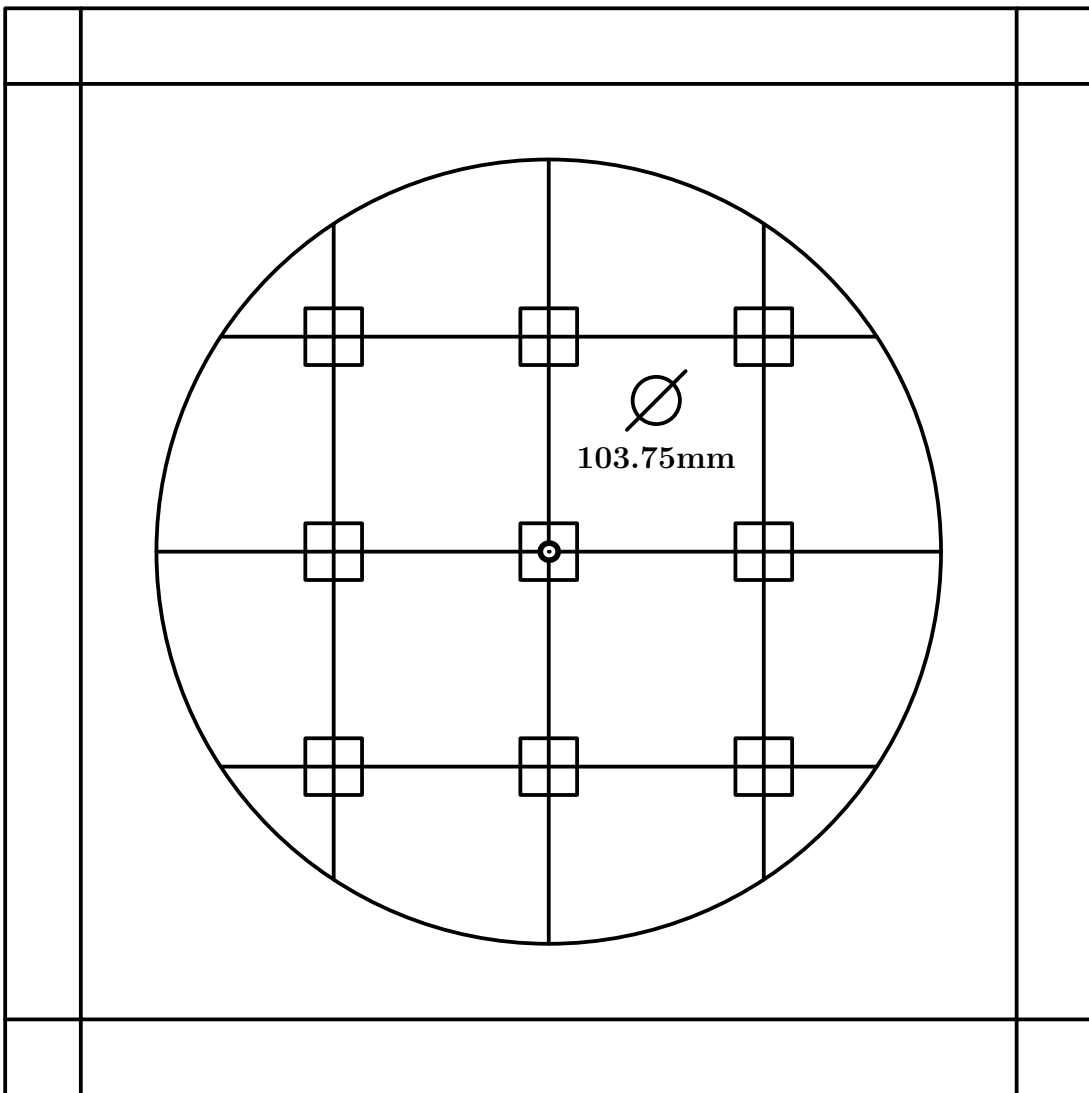

Fig. 16

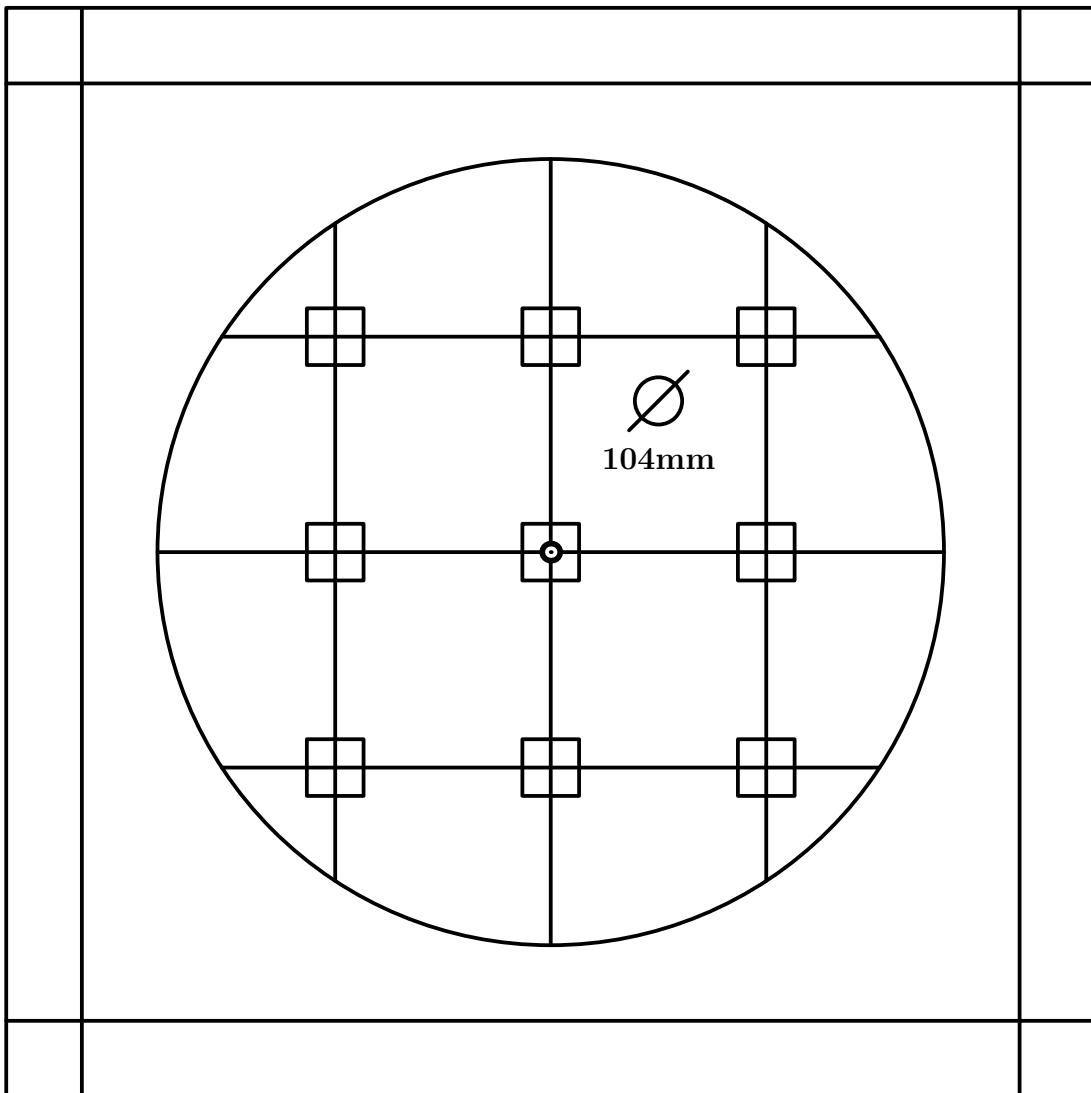

Fig. 17

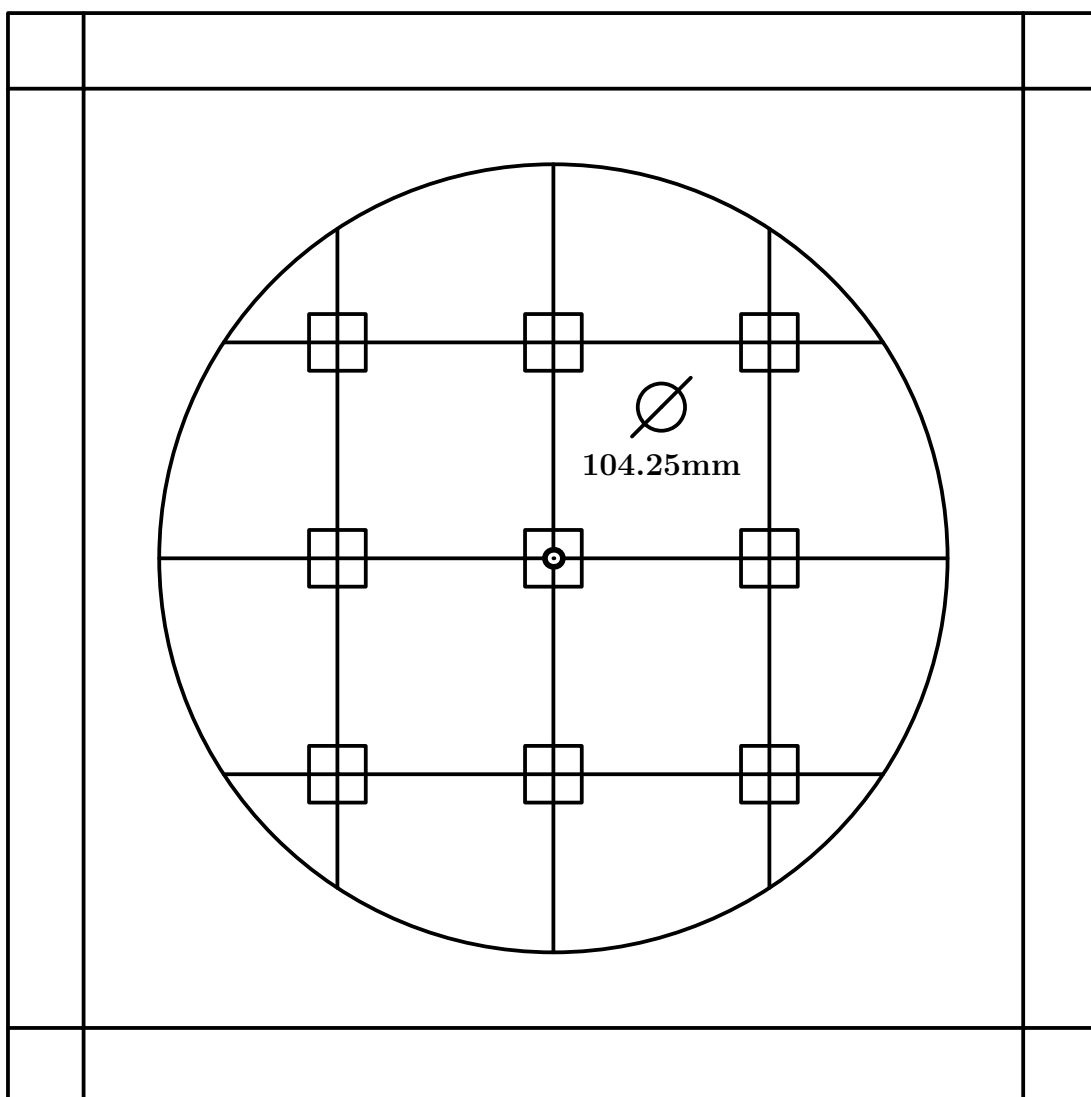

Fig. 18

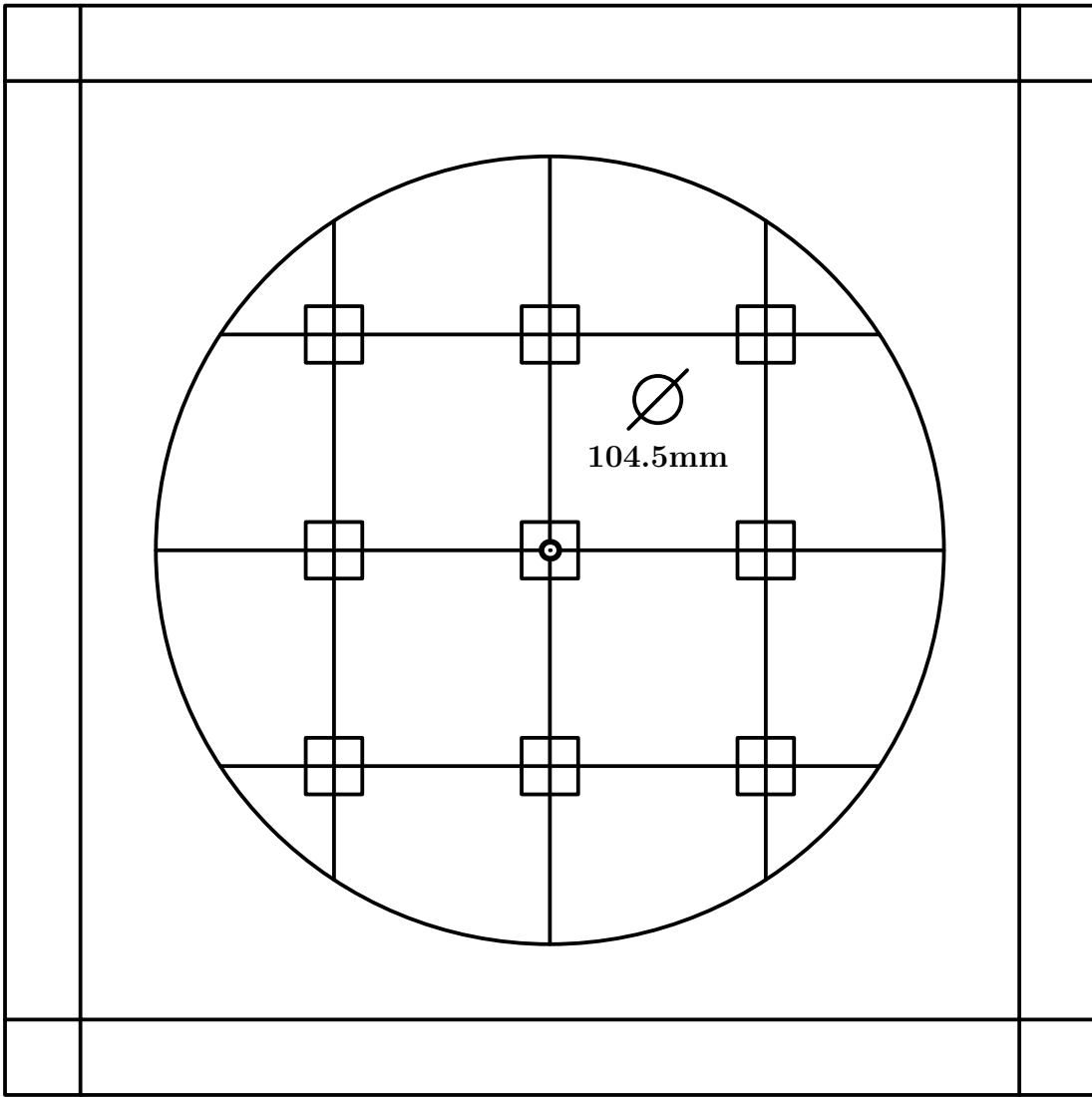

Fig. 19

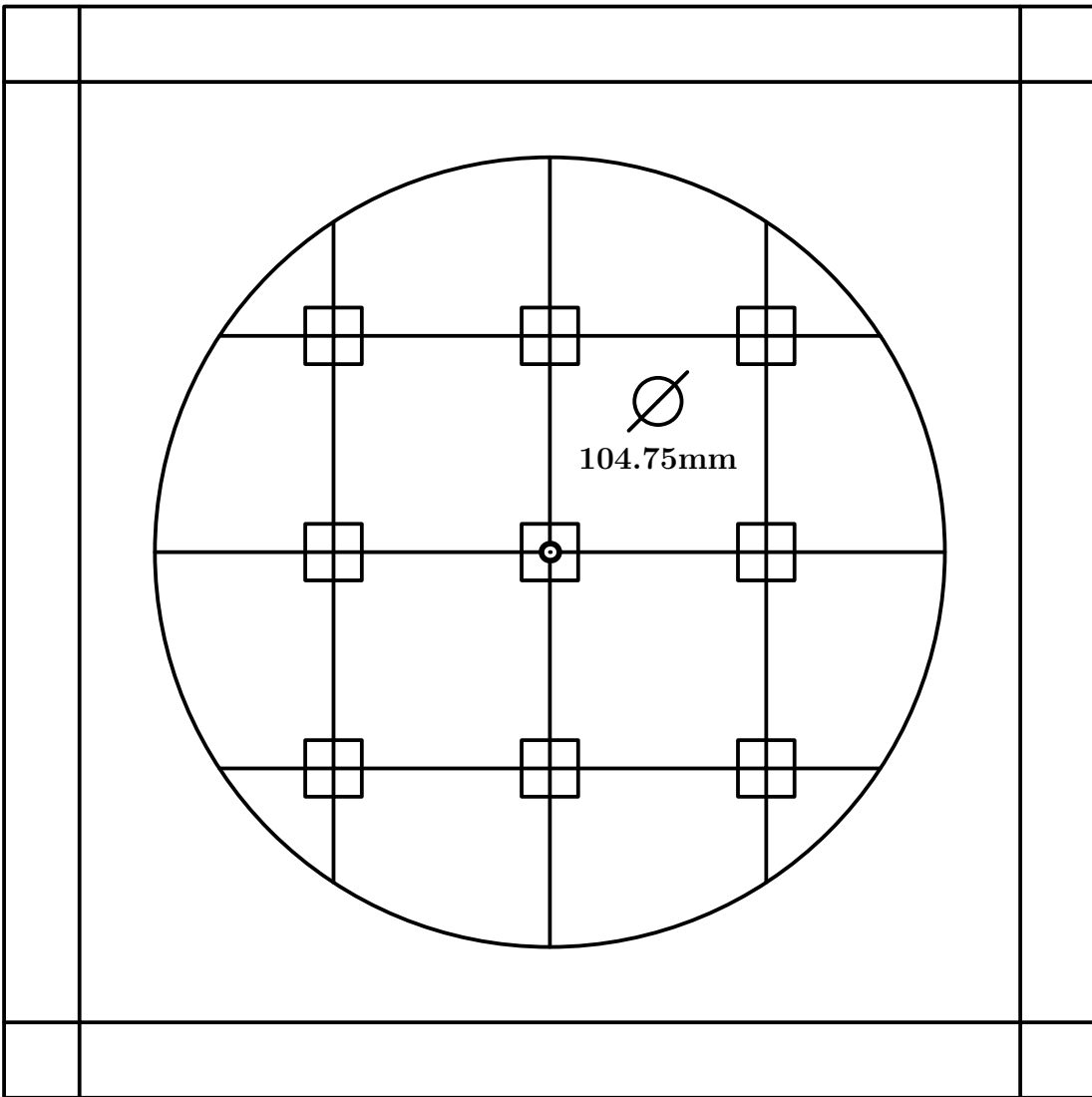

Fig. 20

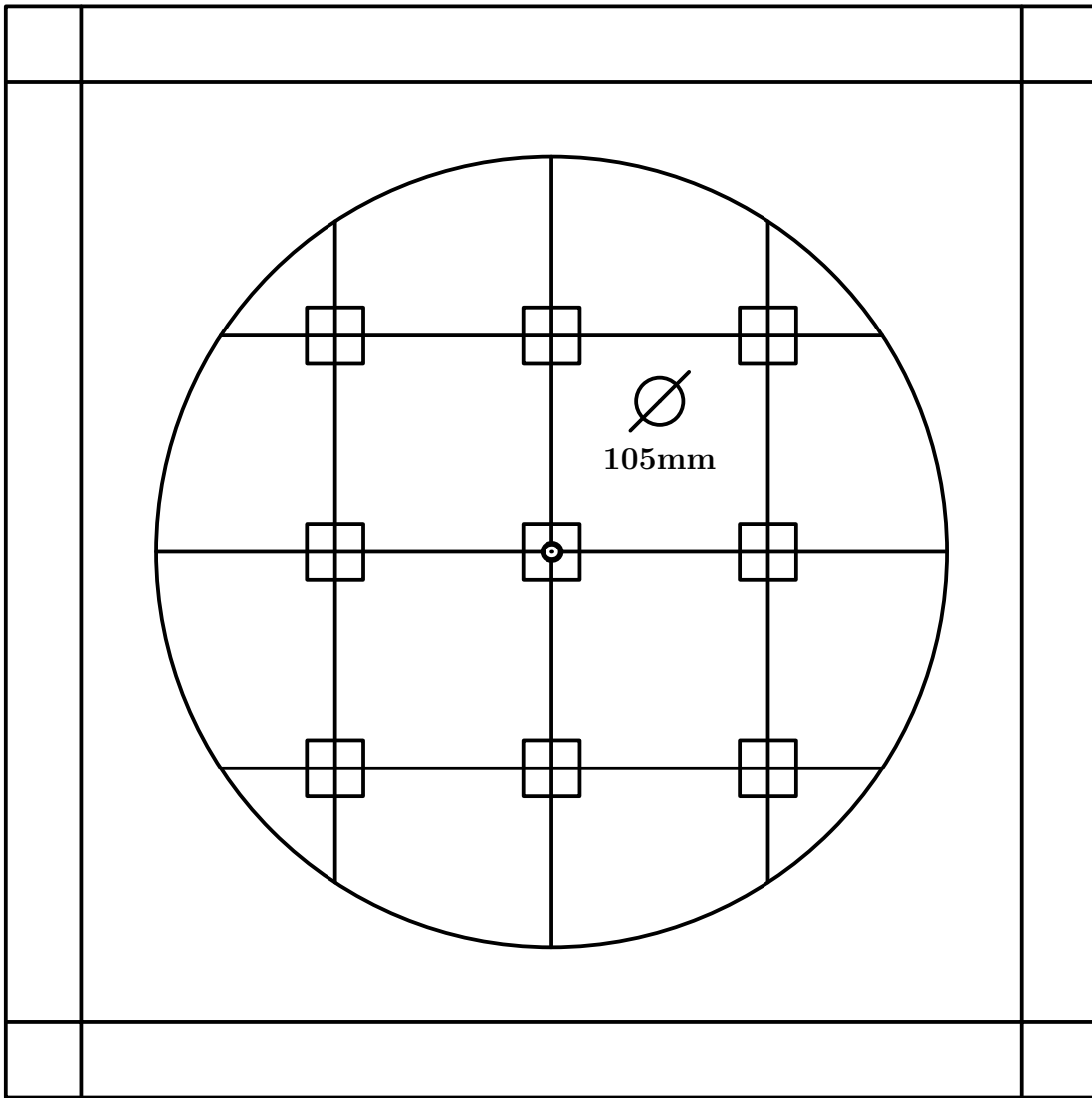

Fig. 21

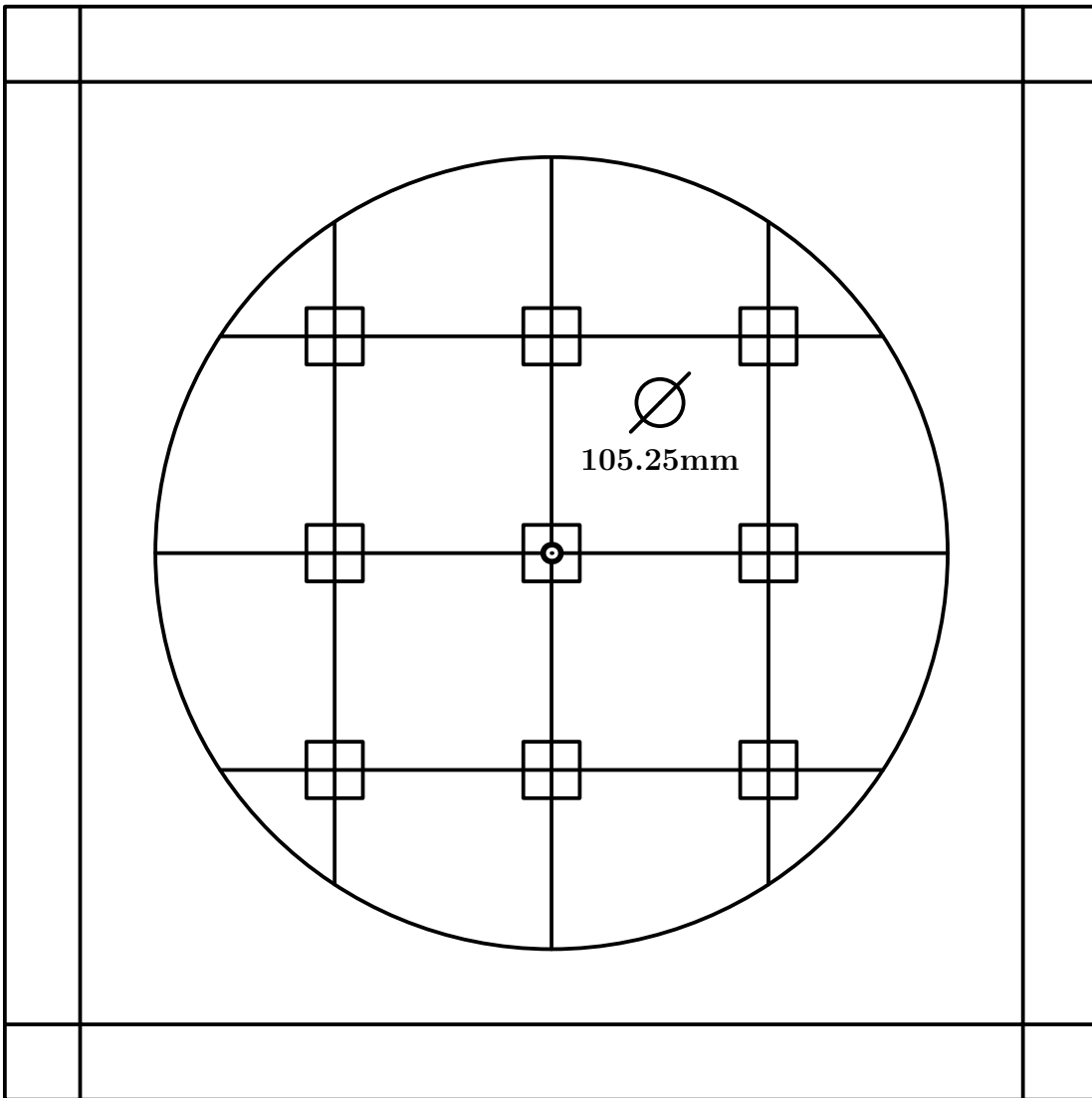

Fig. 22

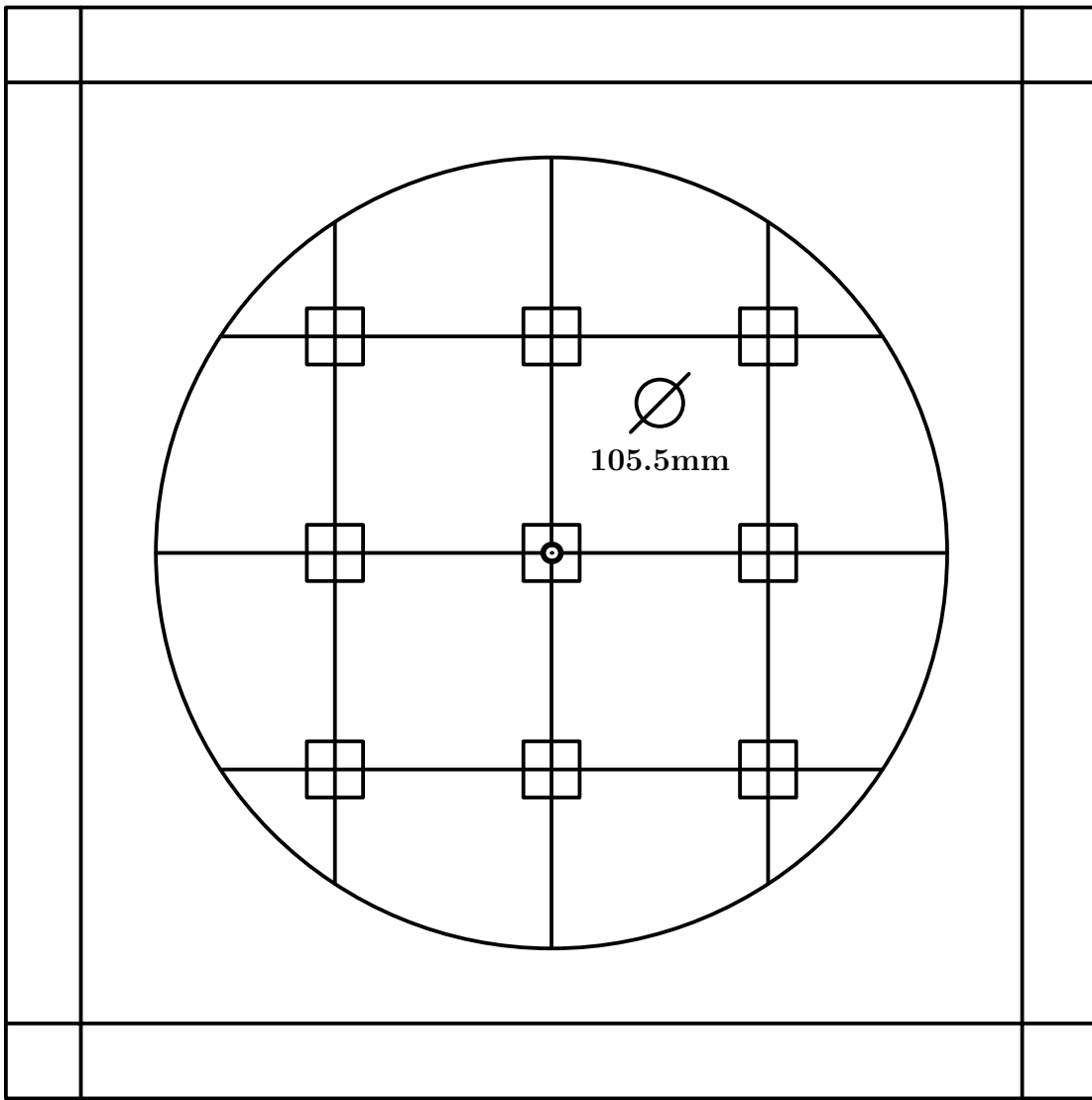

Fig. 23

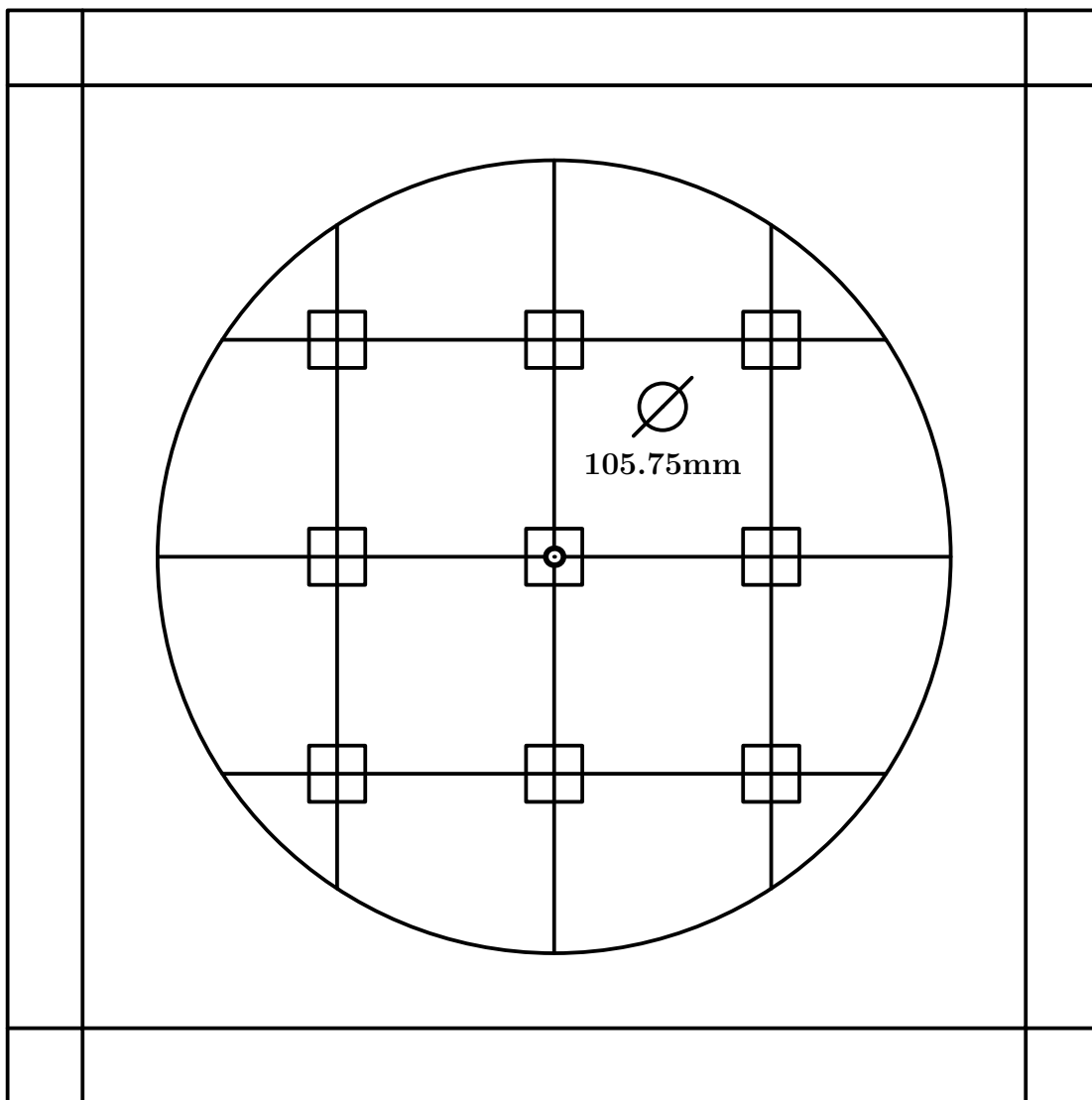

Fig. 24

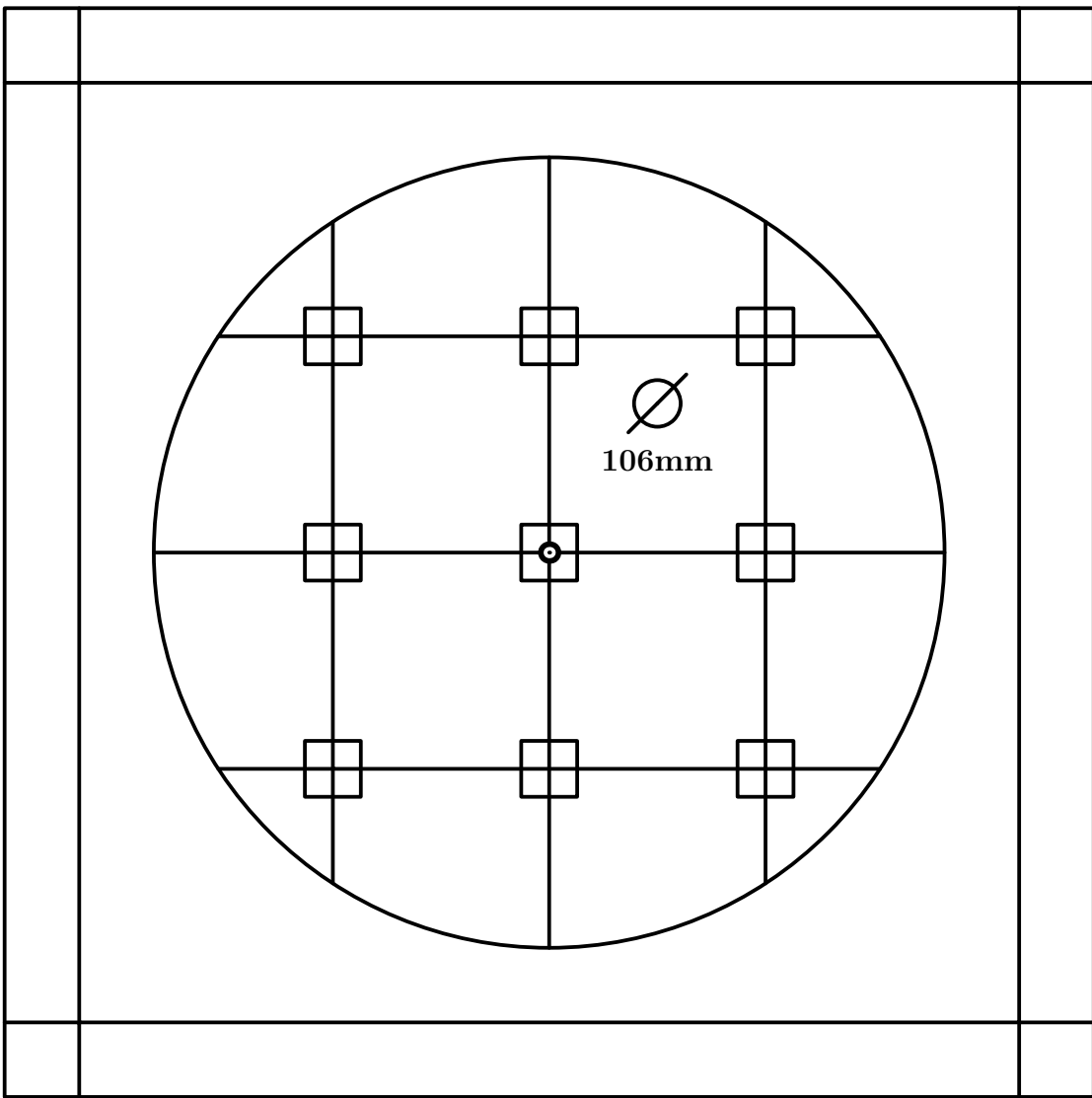

Fig. 25

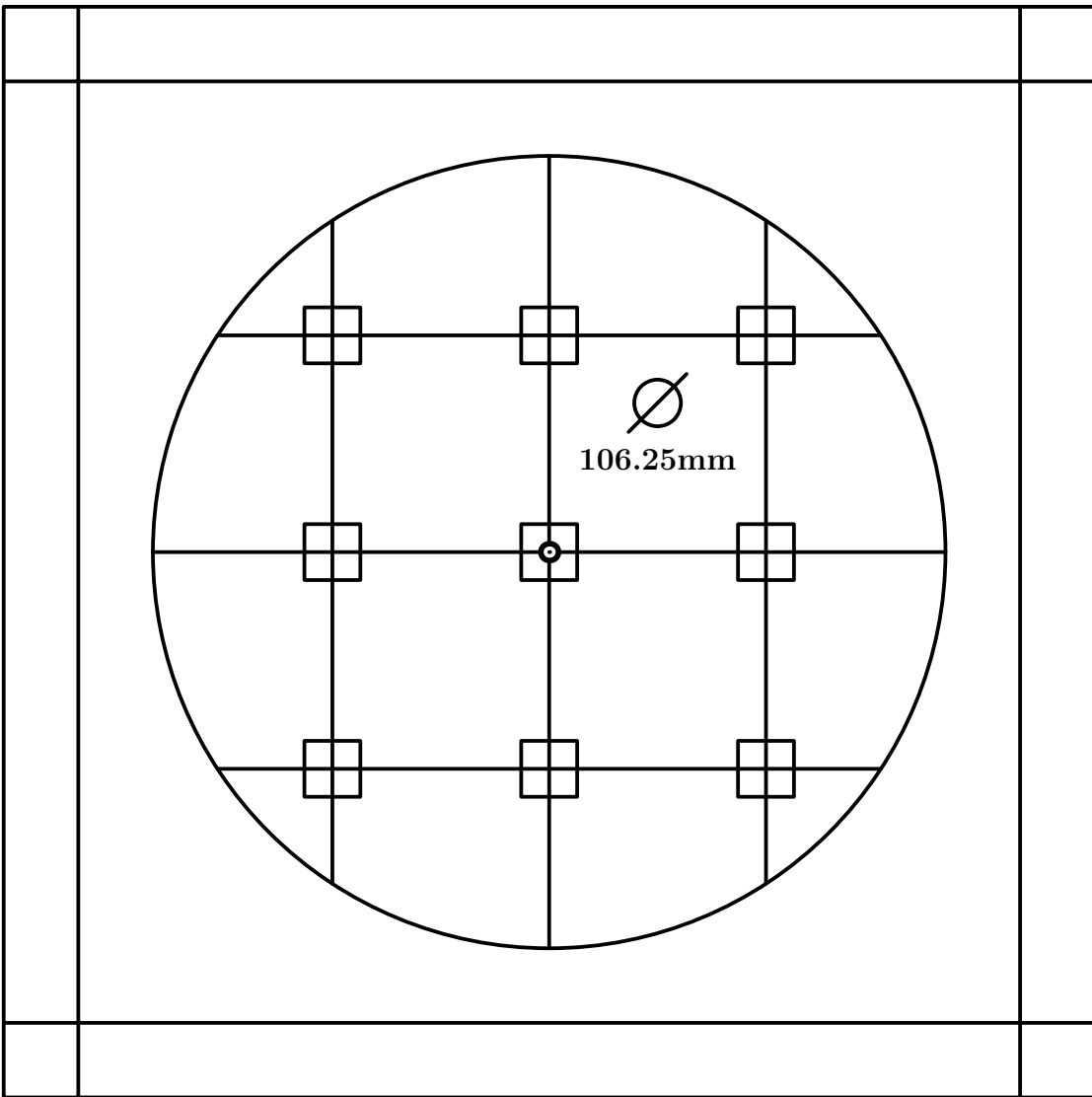

Fig. 26

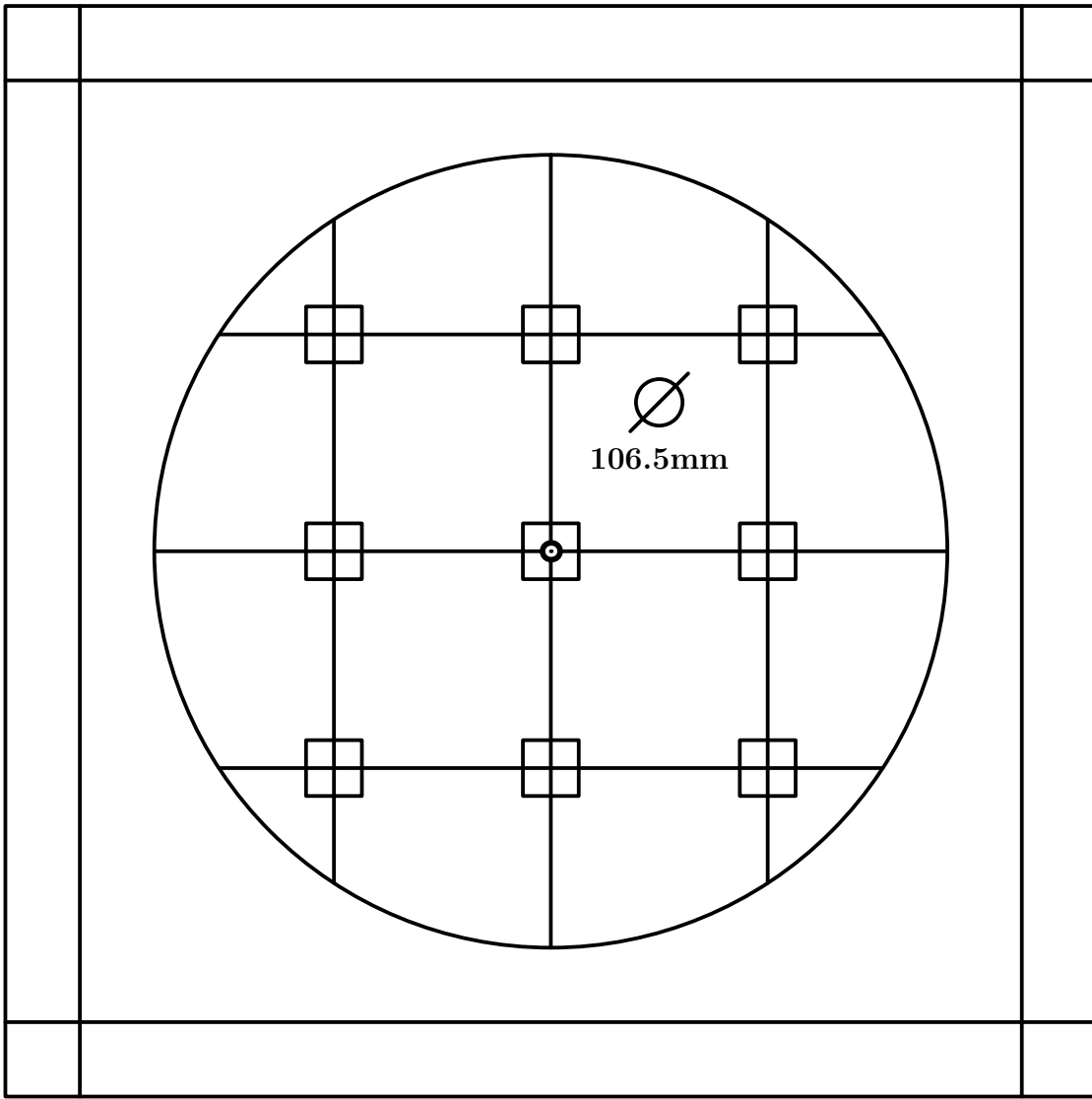

Fig. 27

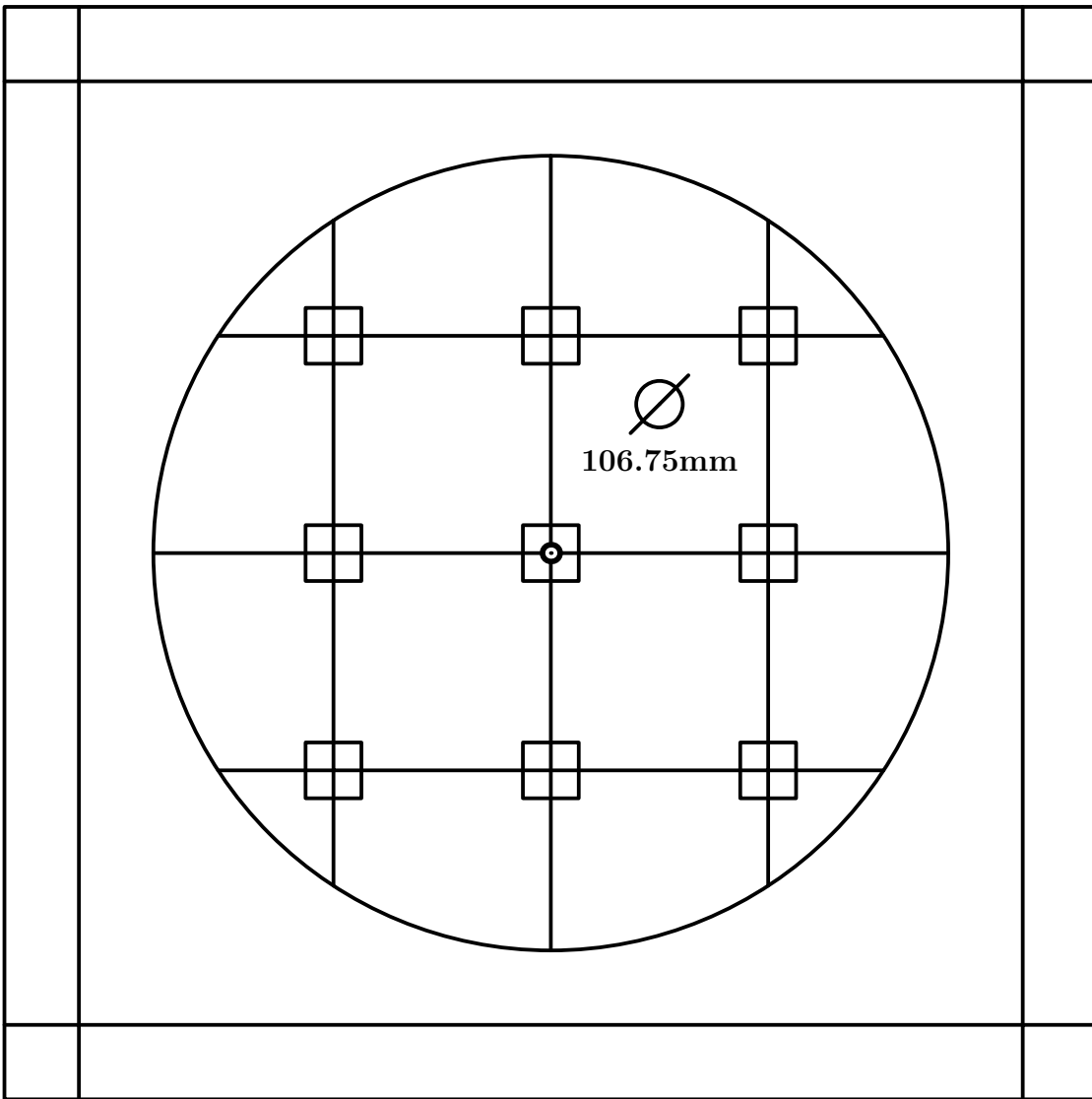

Fig. 28

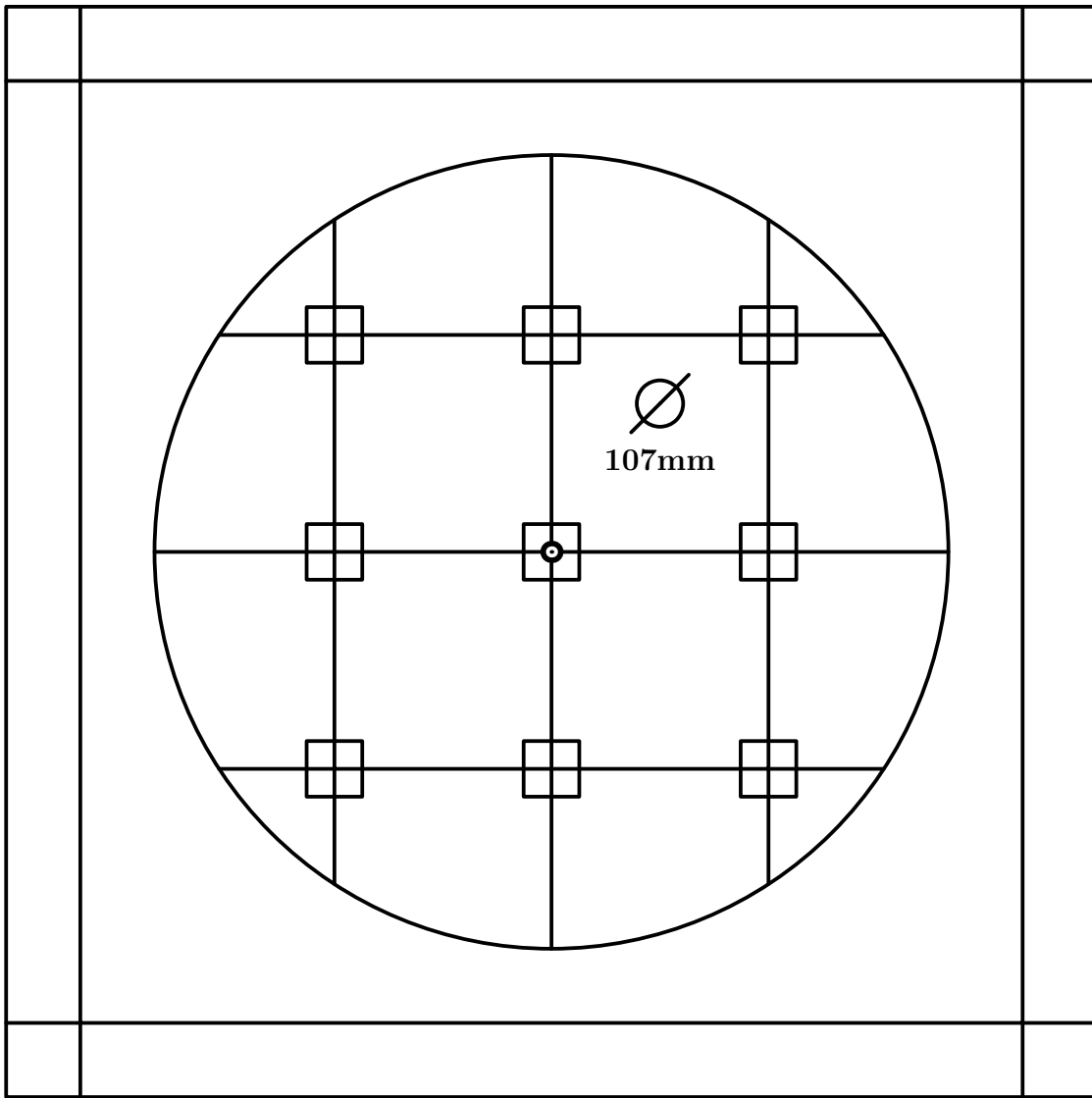

Fig. 29

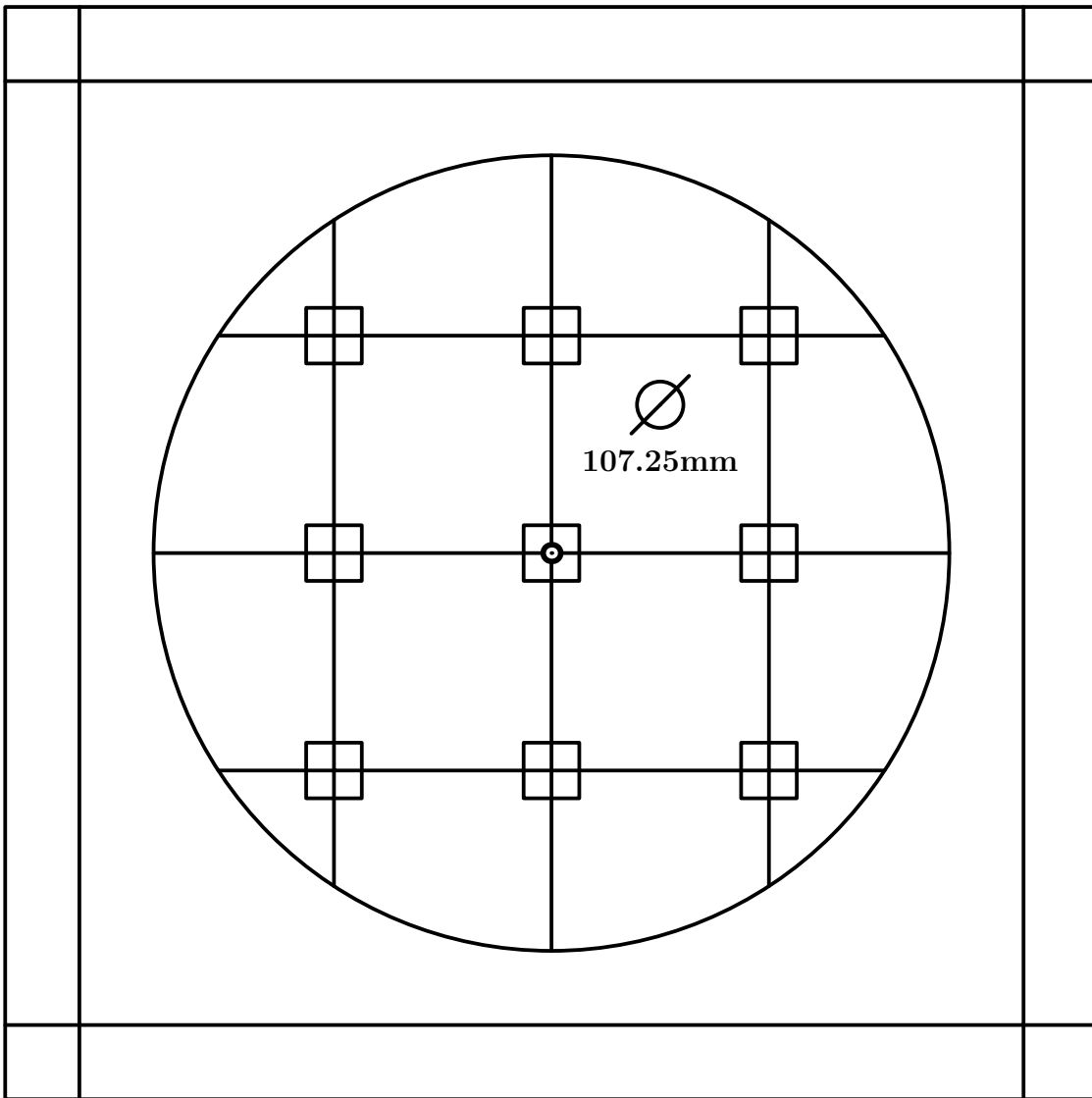

Fig. 30

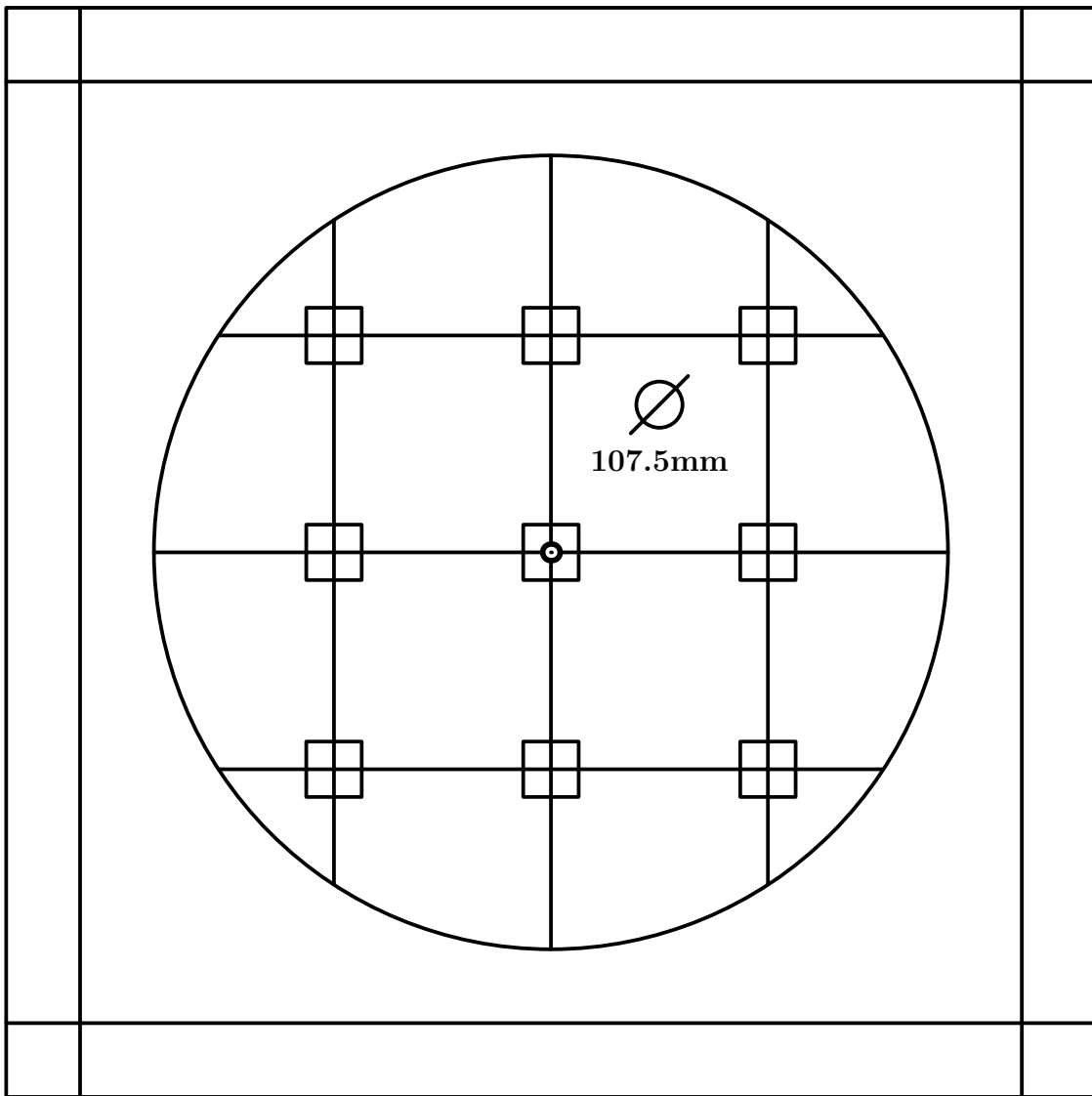

Fig. 31

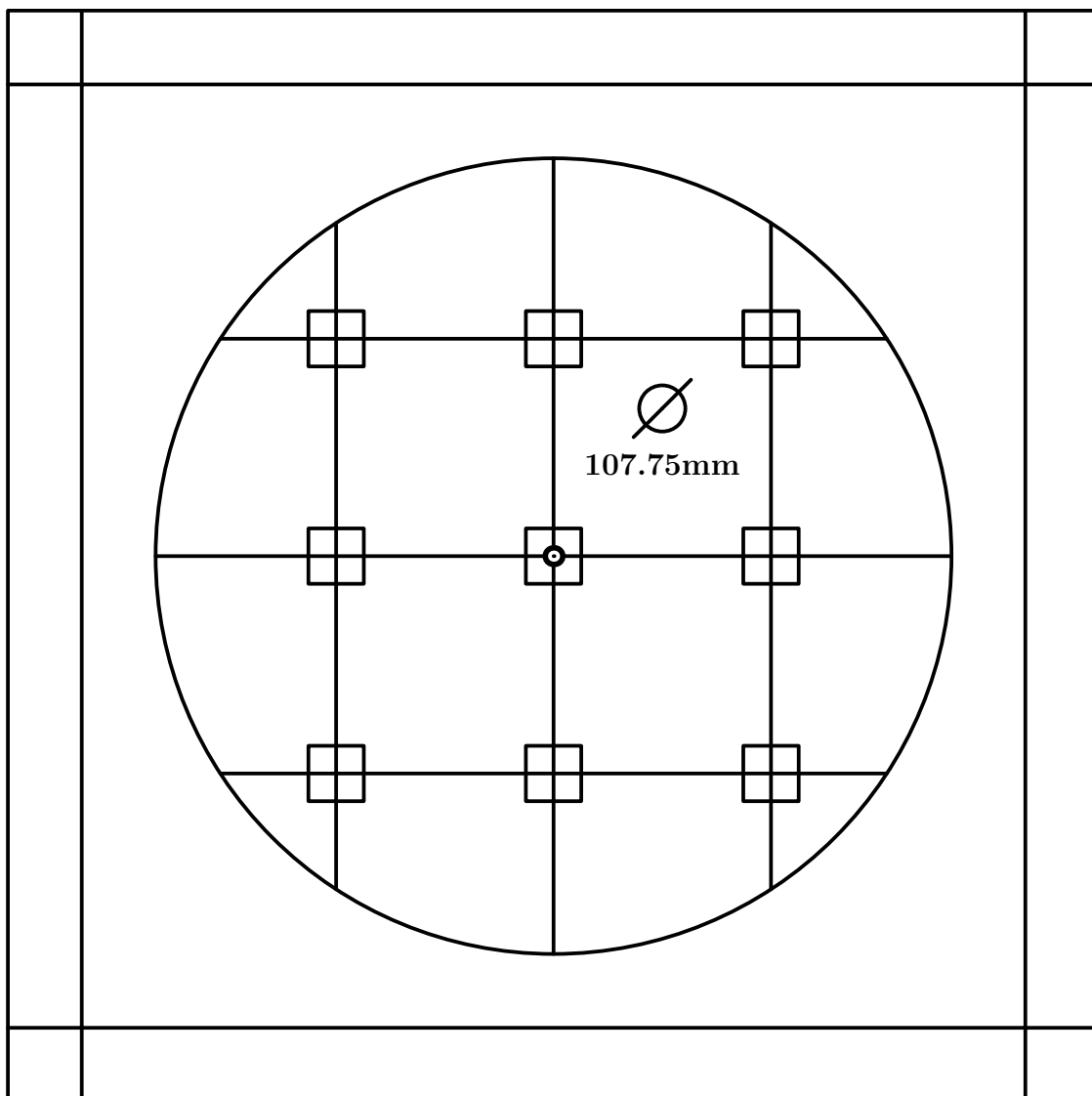

Fig. 32

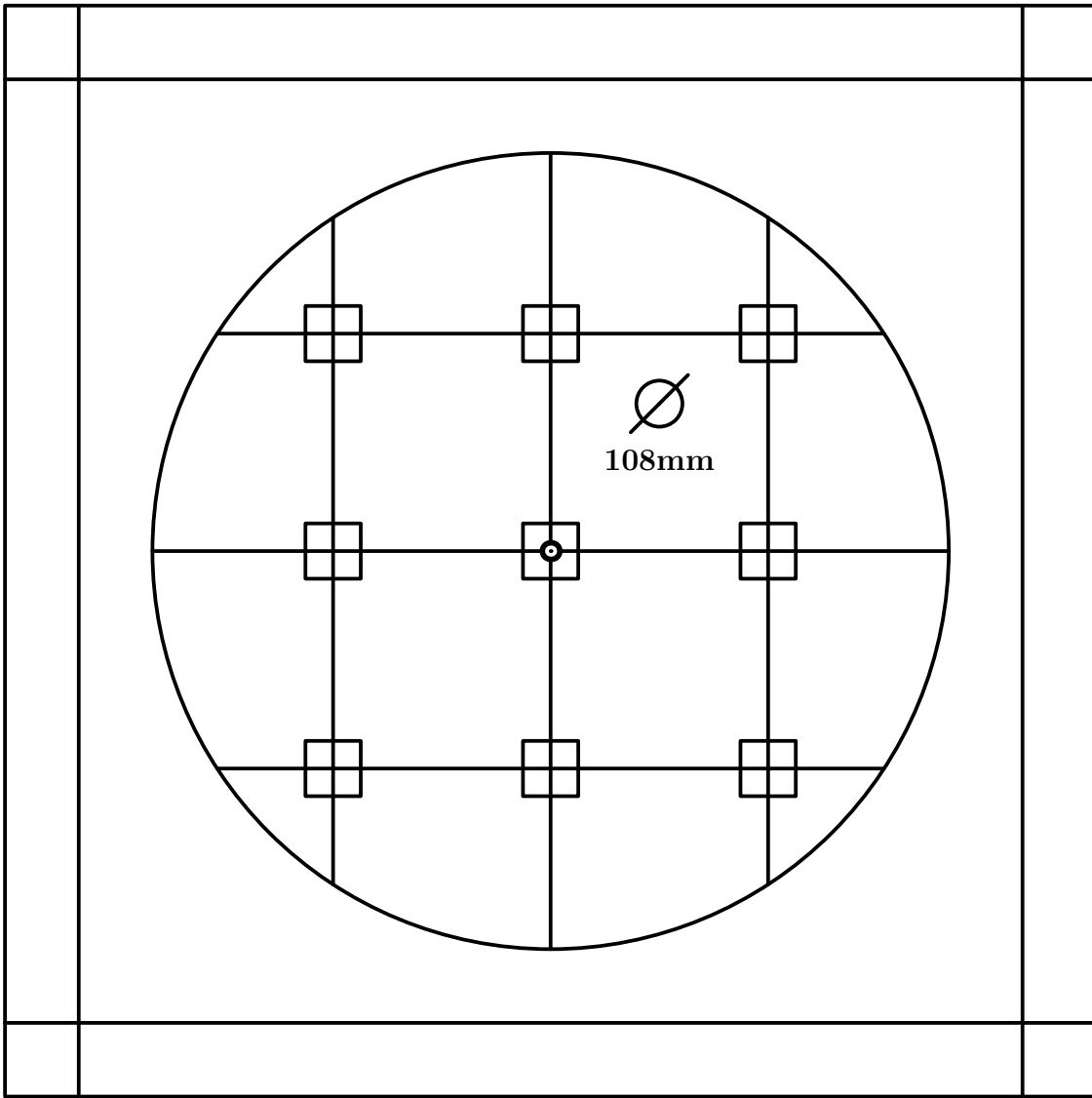

Fig. 33

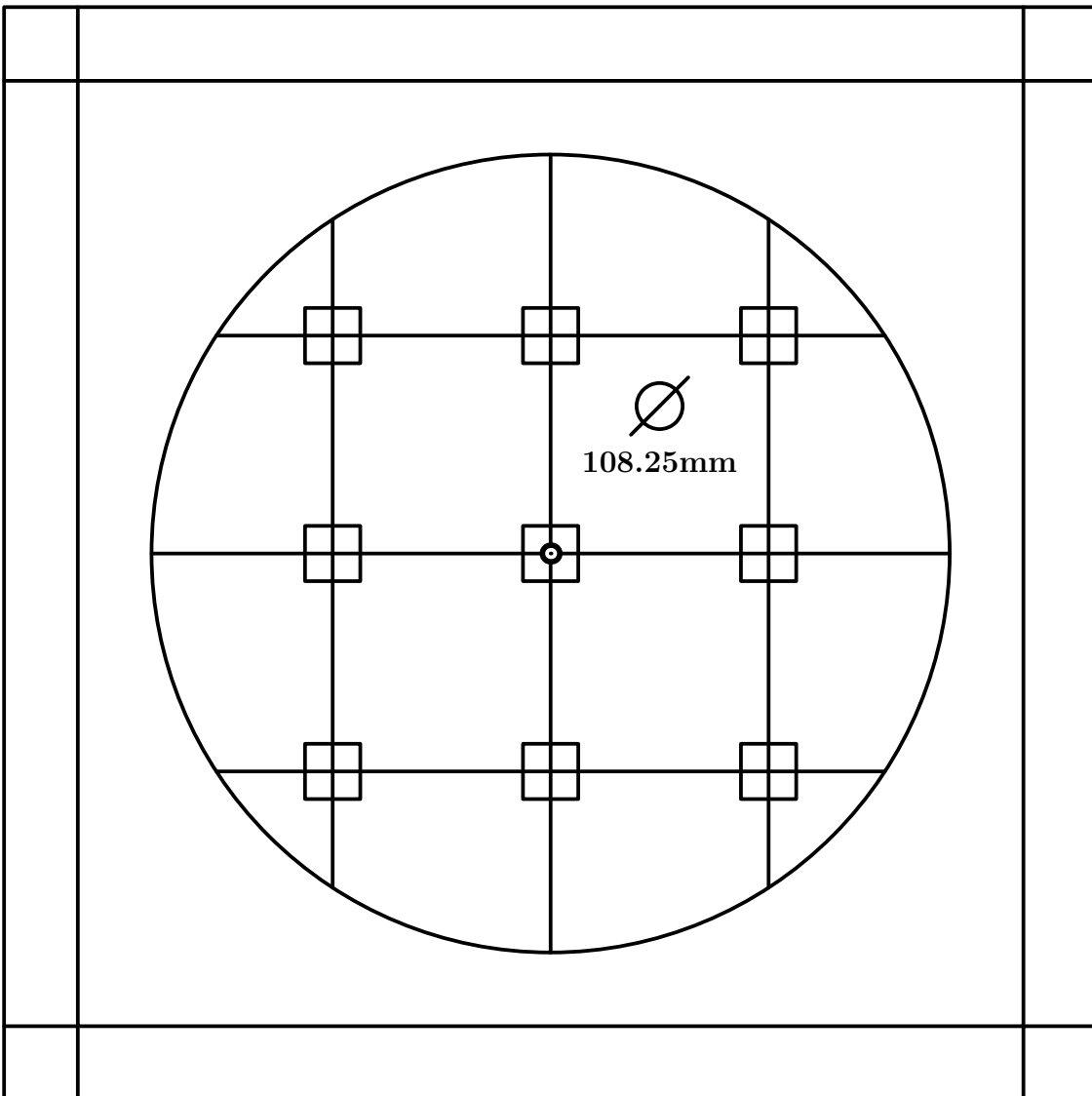

Fig. 34

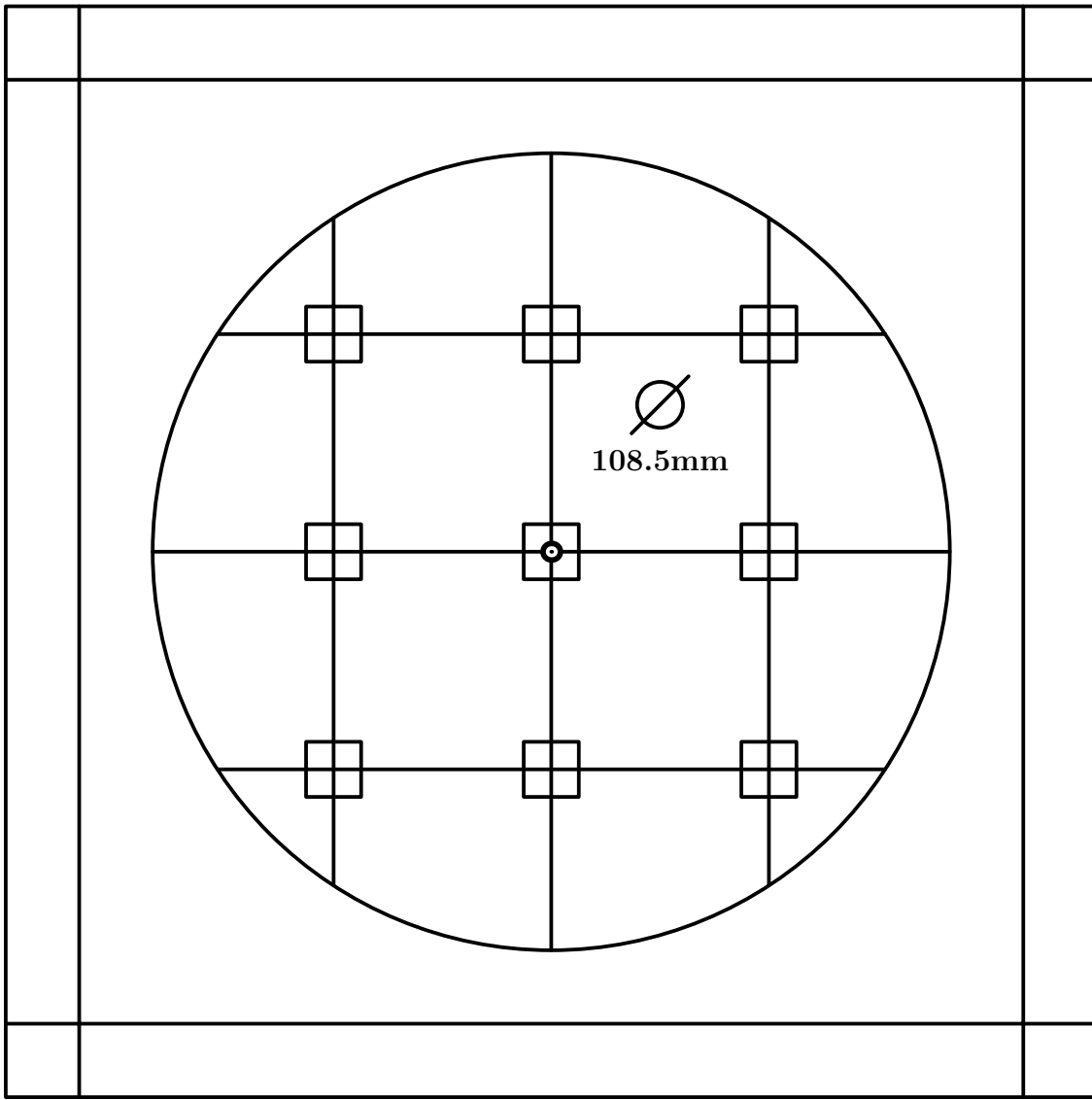

Fig. 35

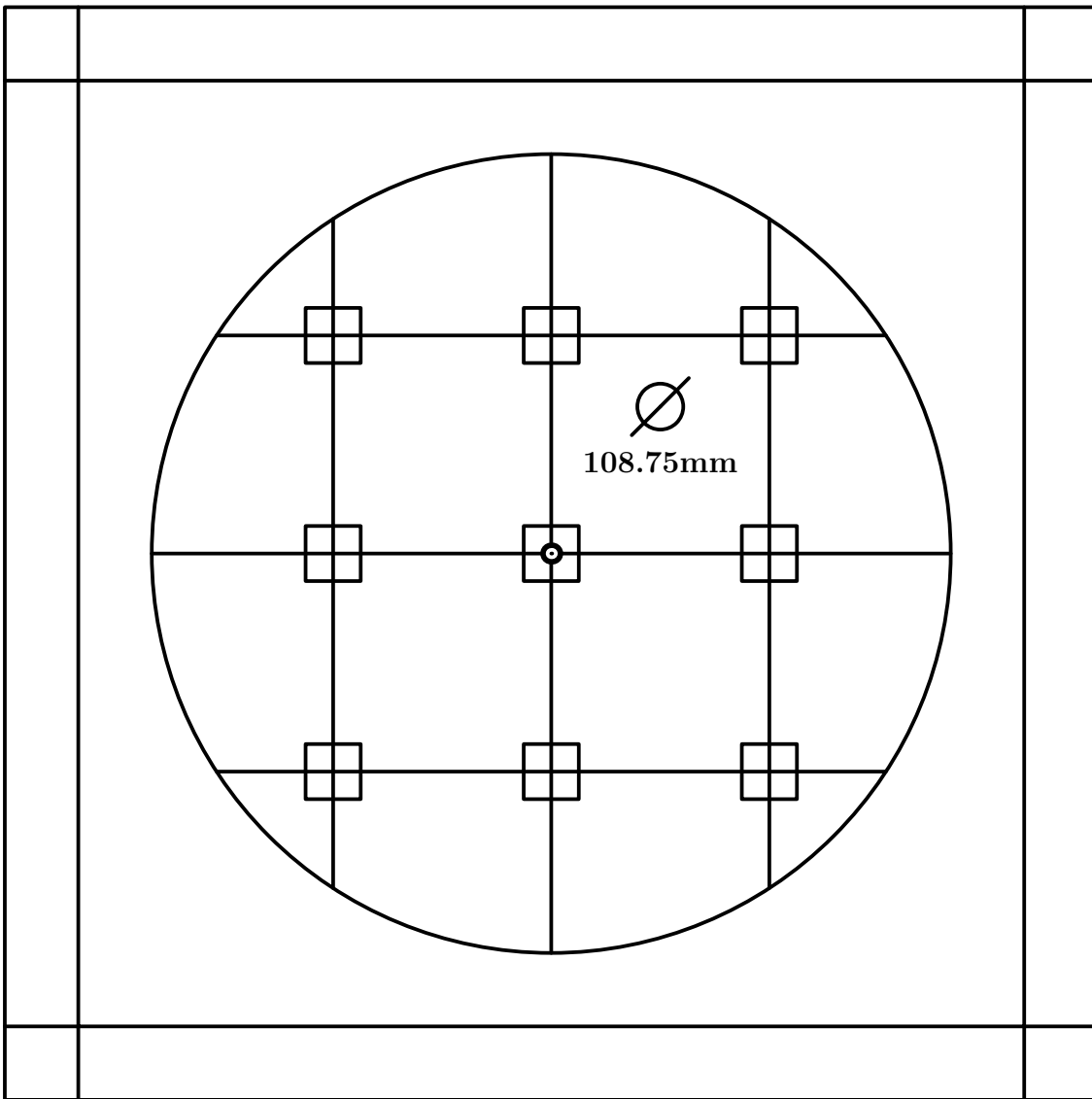

Fig. 36

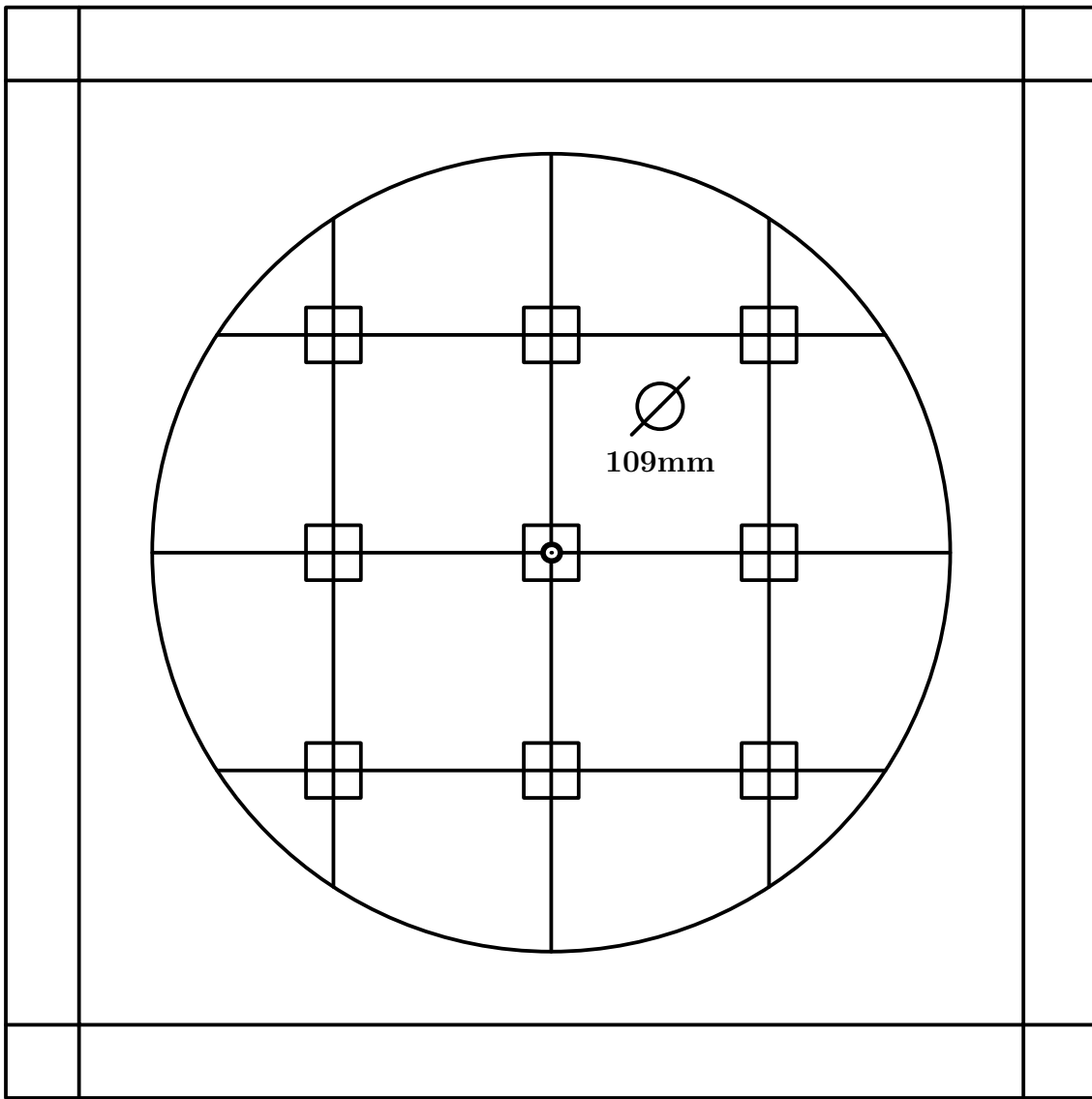

Fig. 37

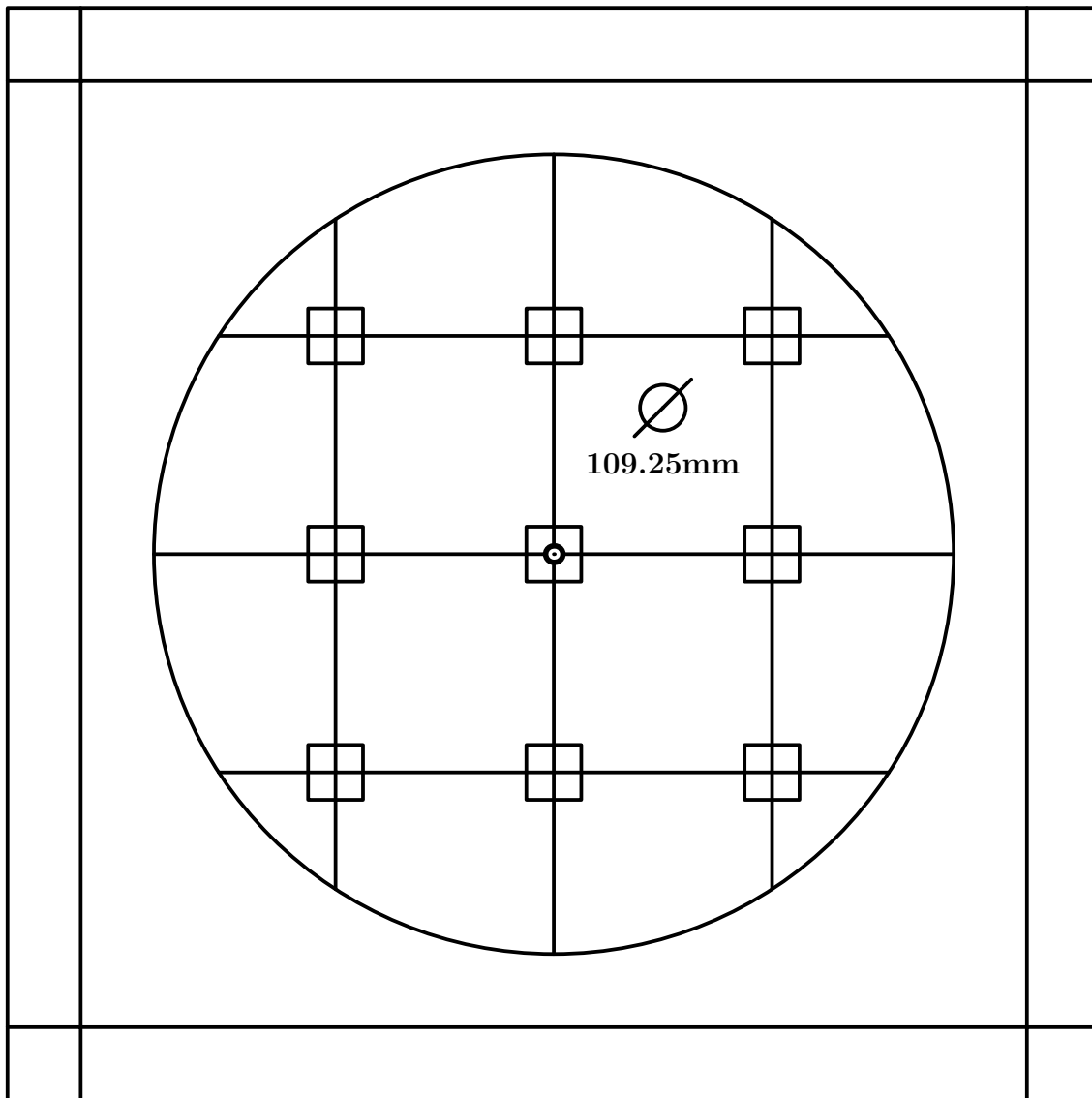

Fig. 38

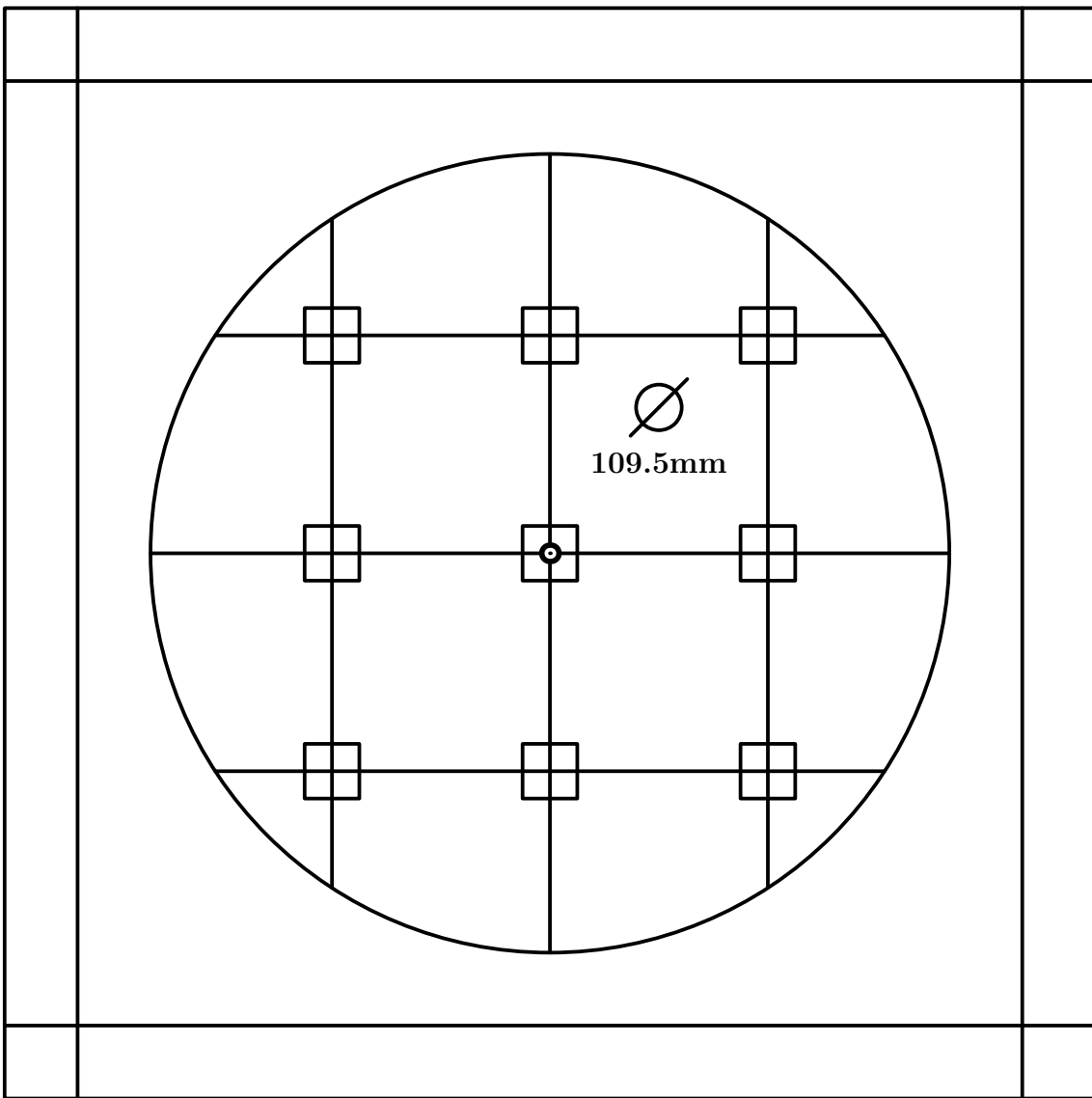

Fig. 39

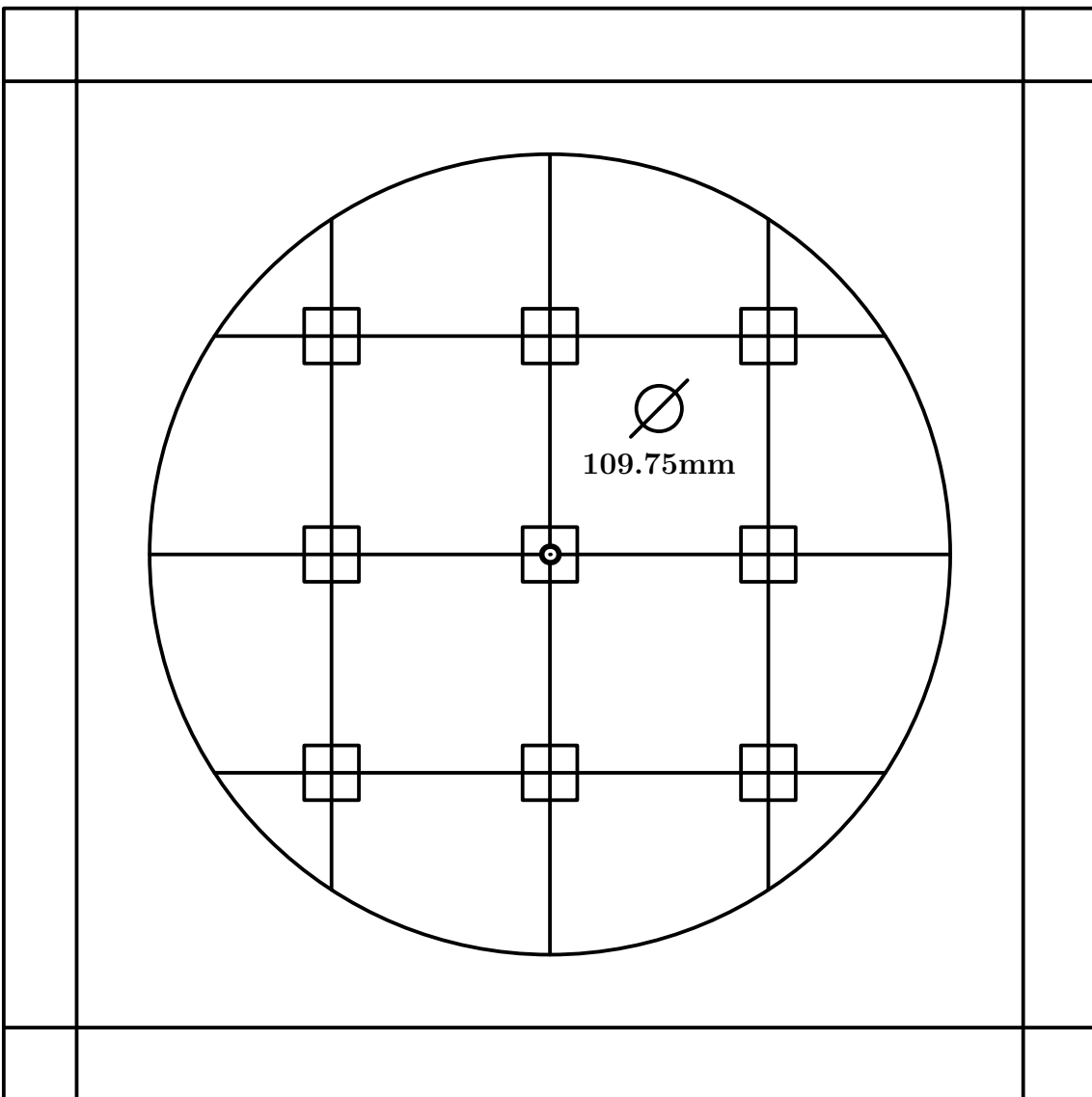

Fig. 40

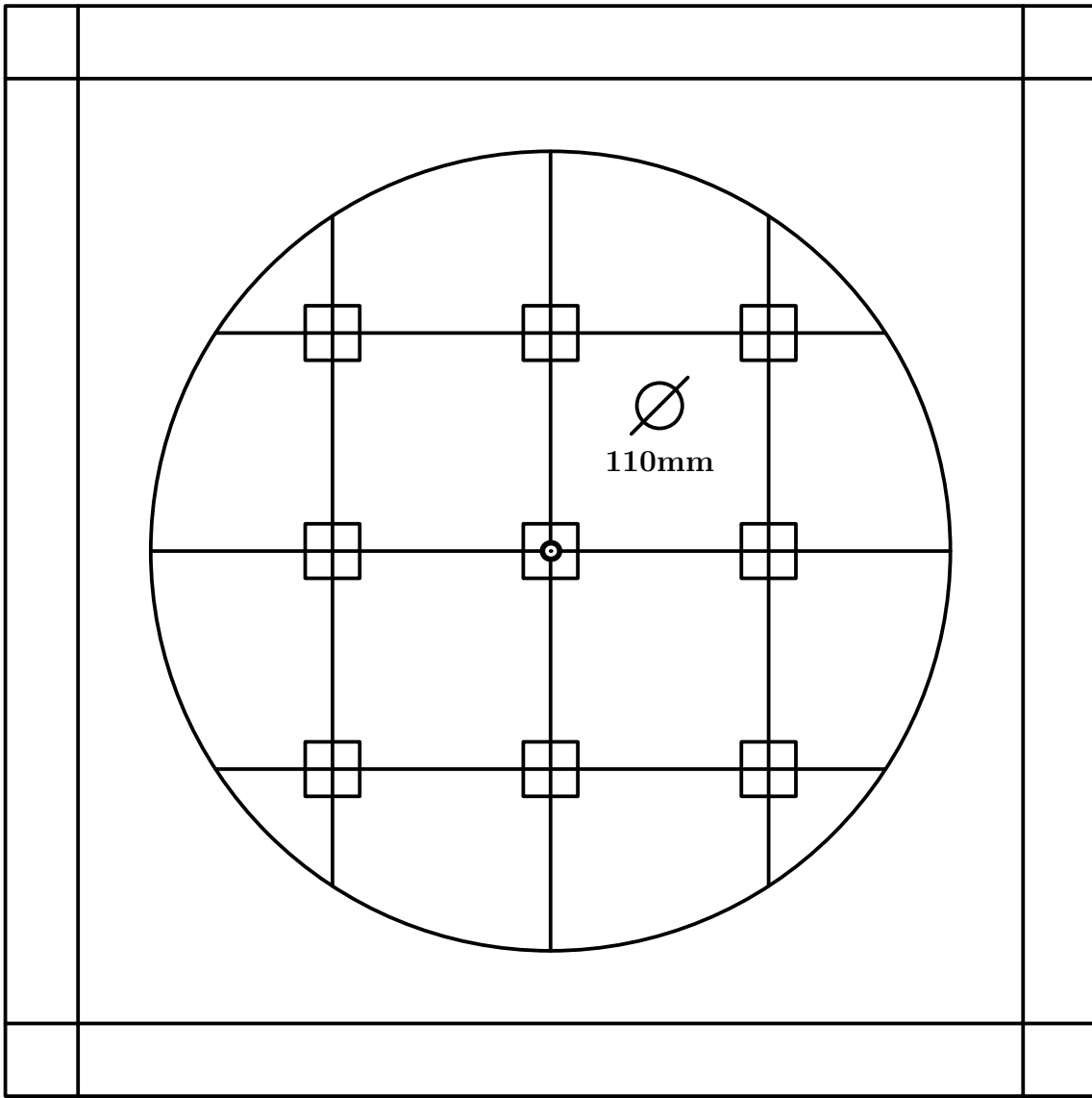

Fig. 41

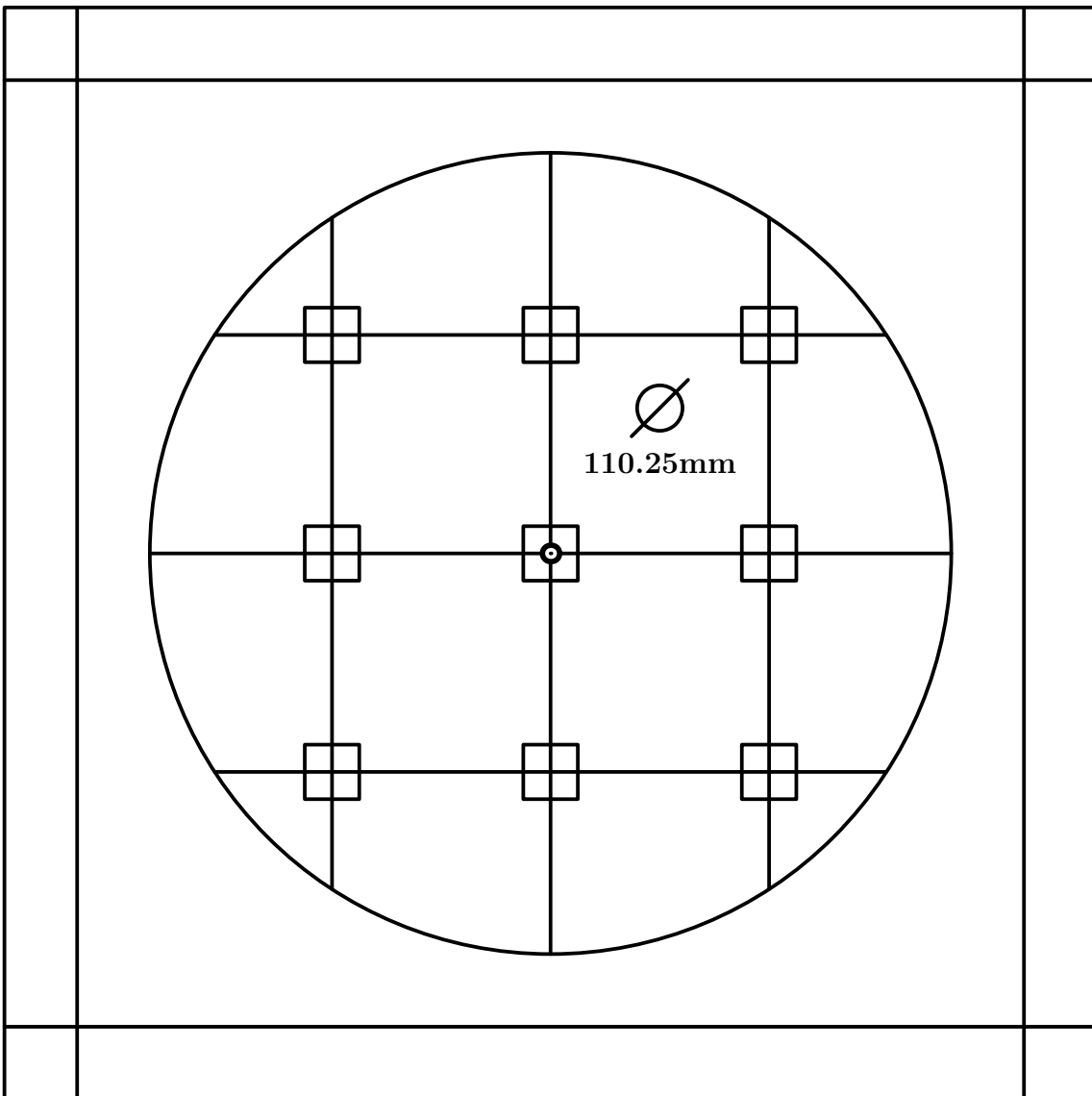

Fig. 42

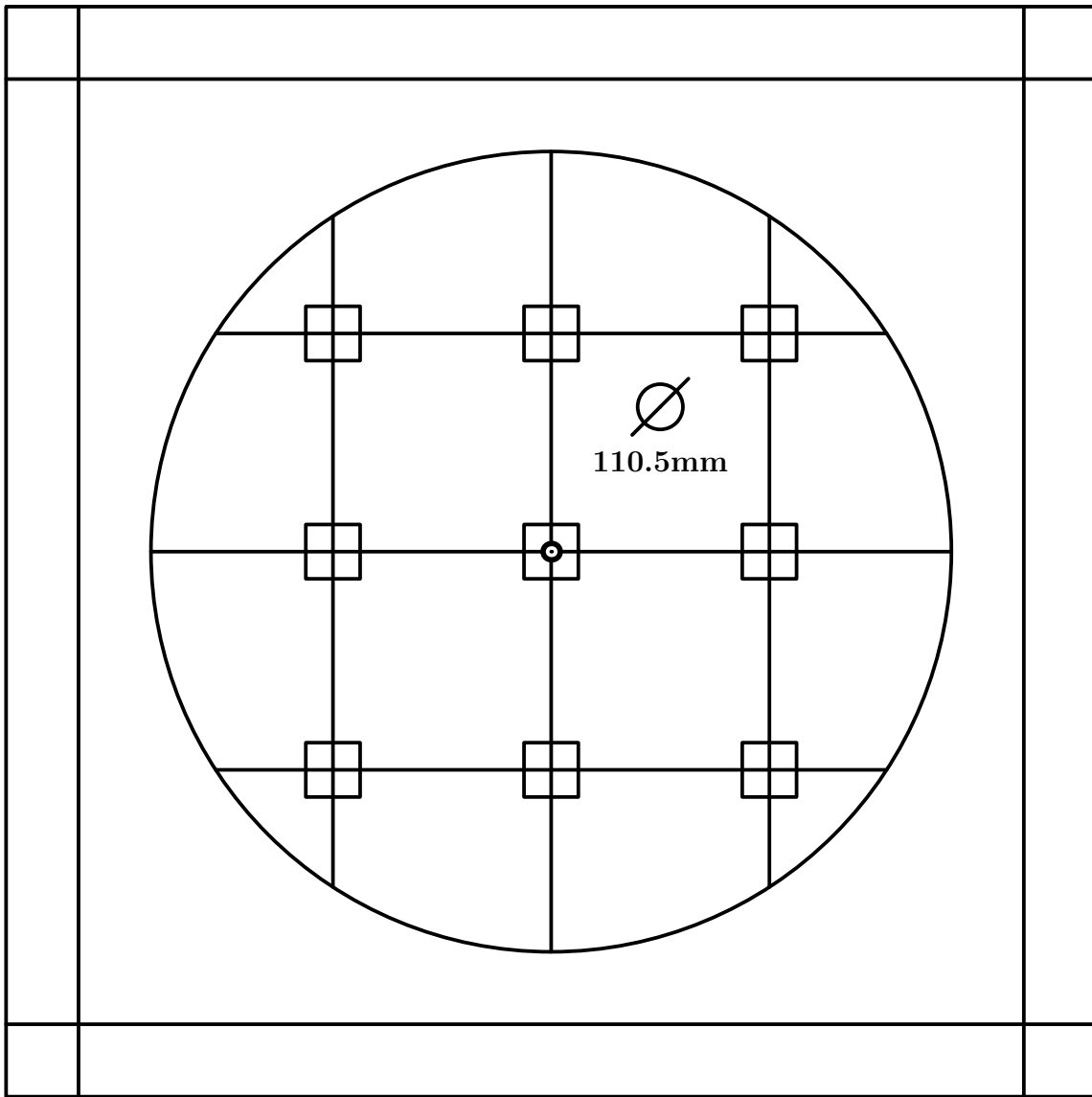

Fig. 43

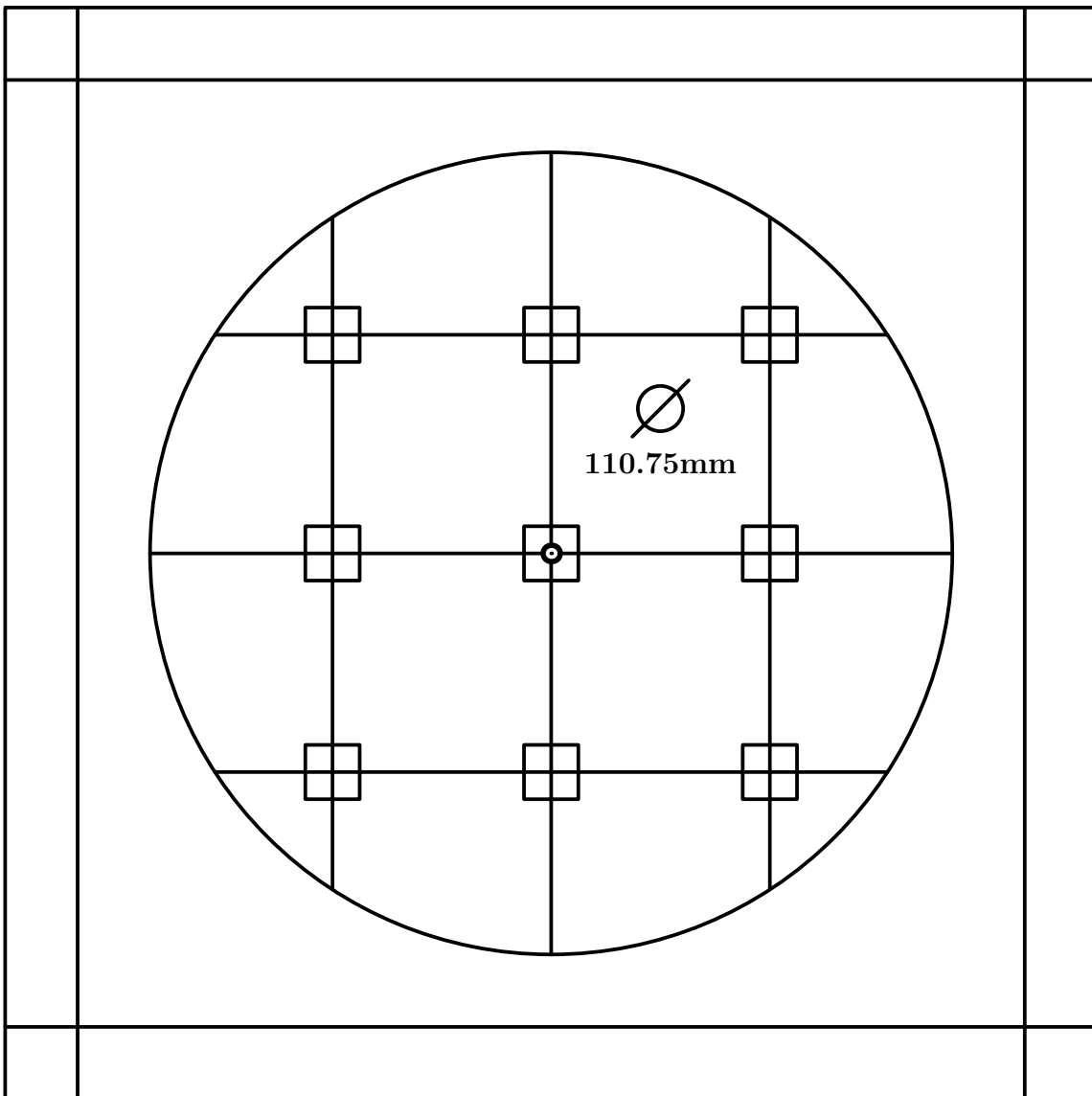

Fig. 44

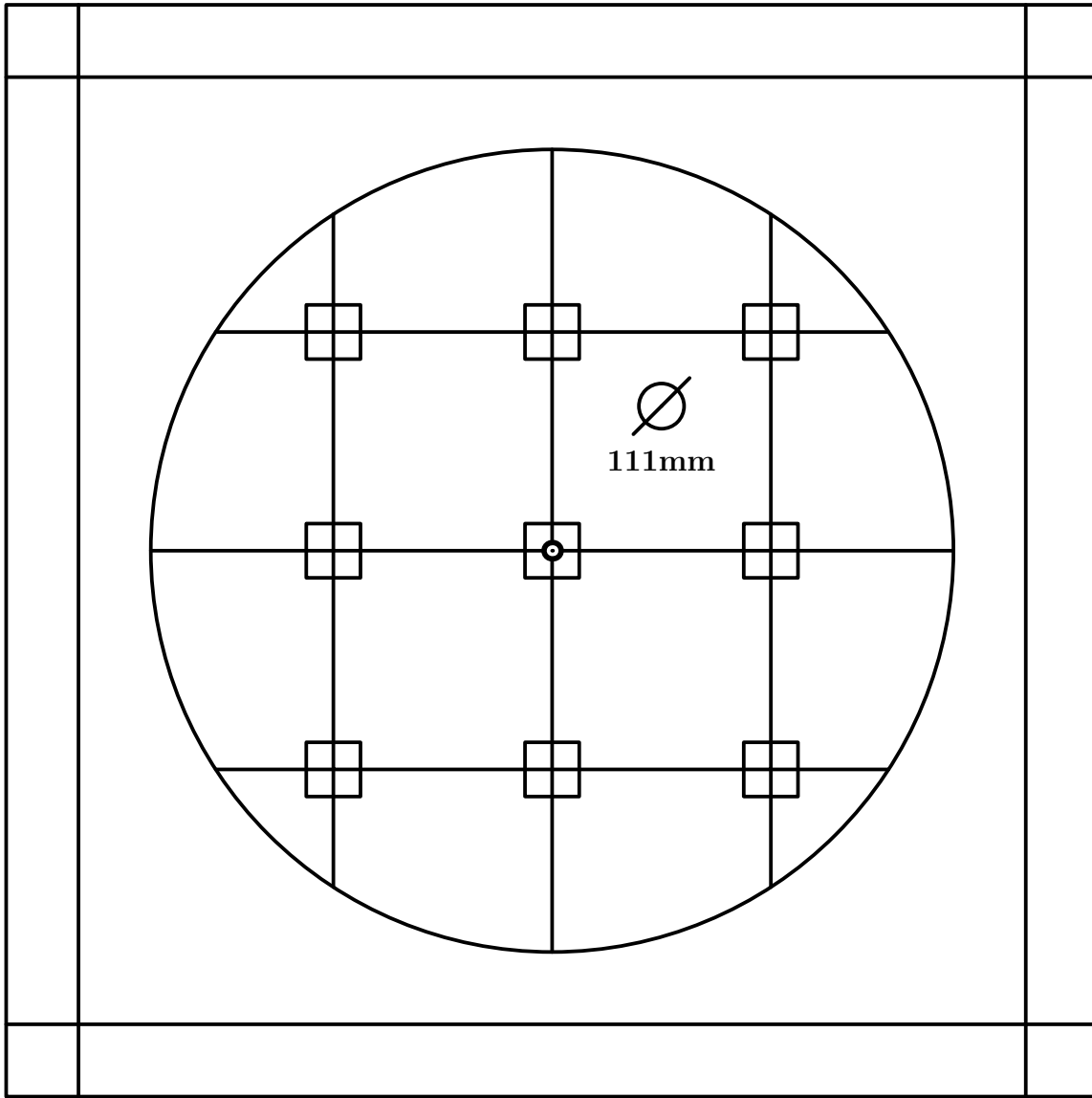

Fig. 45

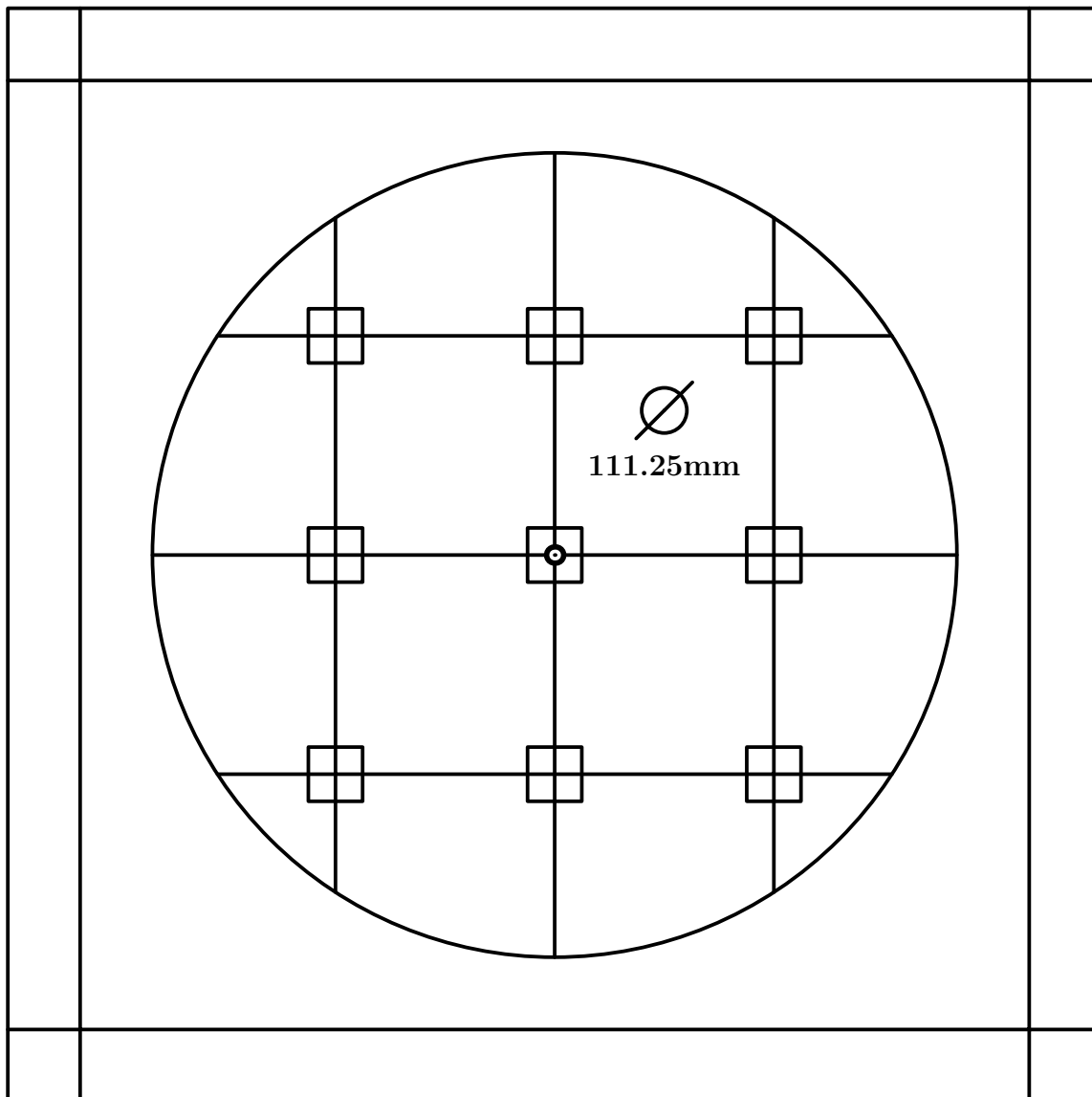

Fig. 46

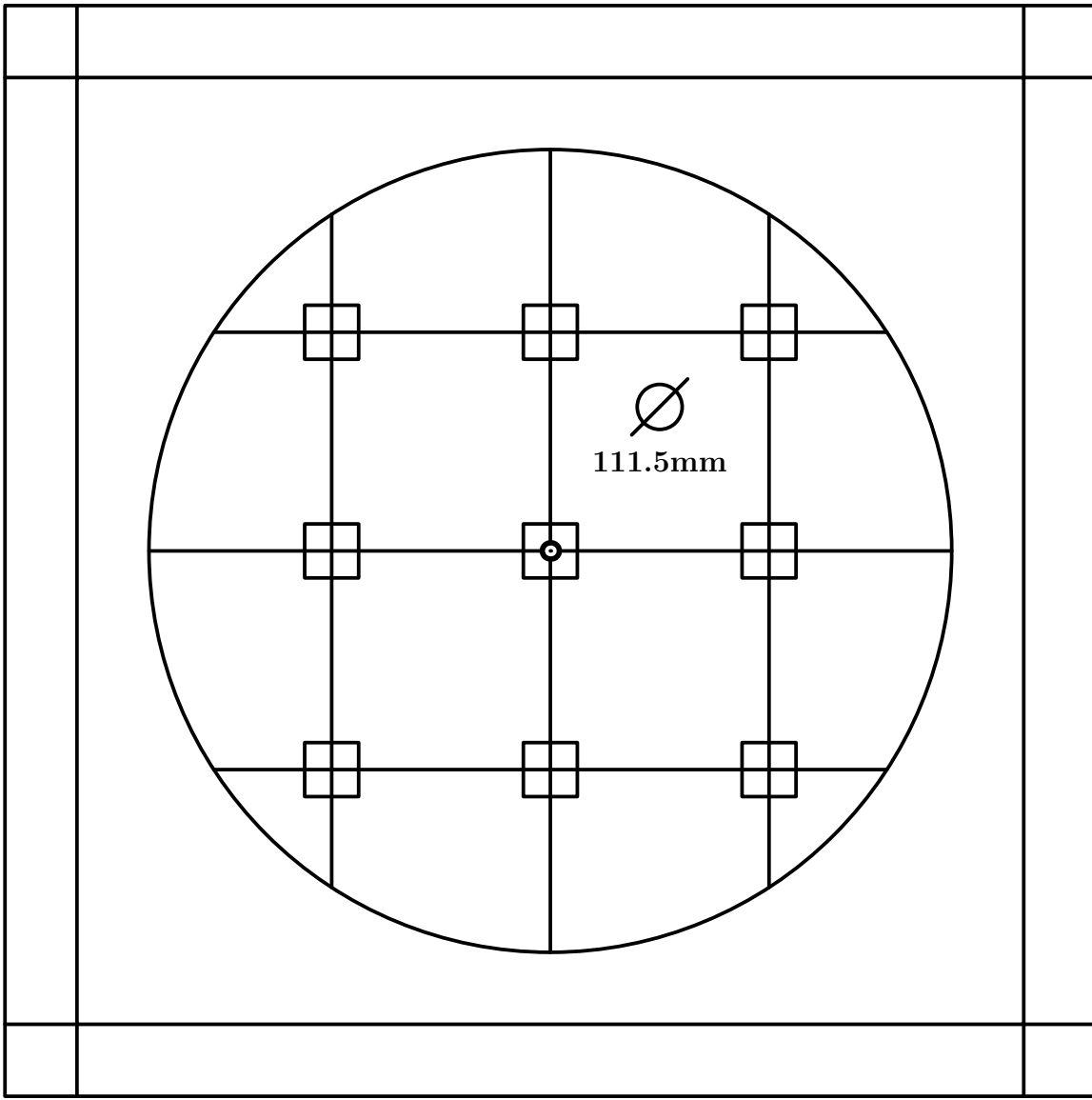

Fig. 47

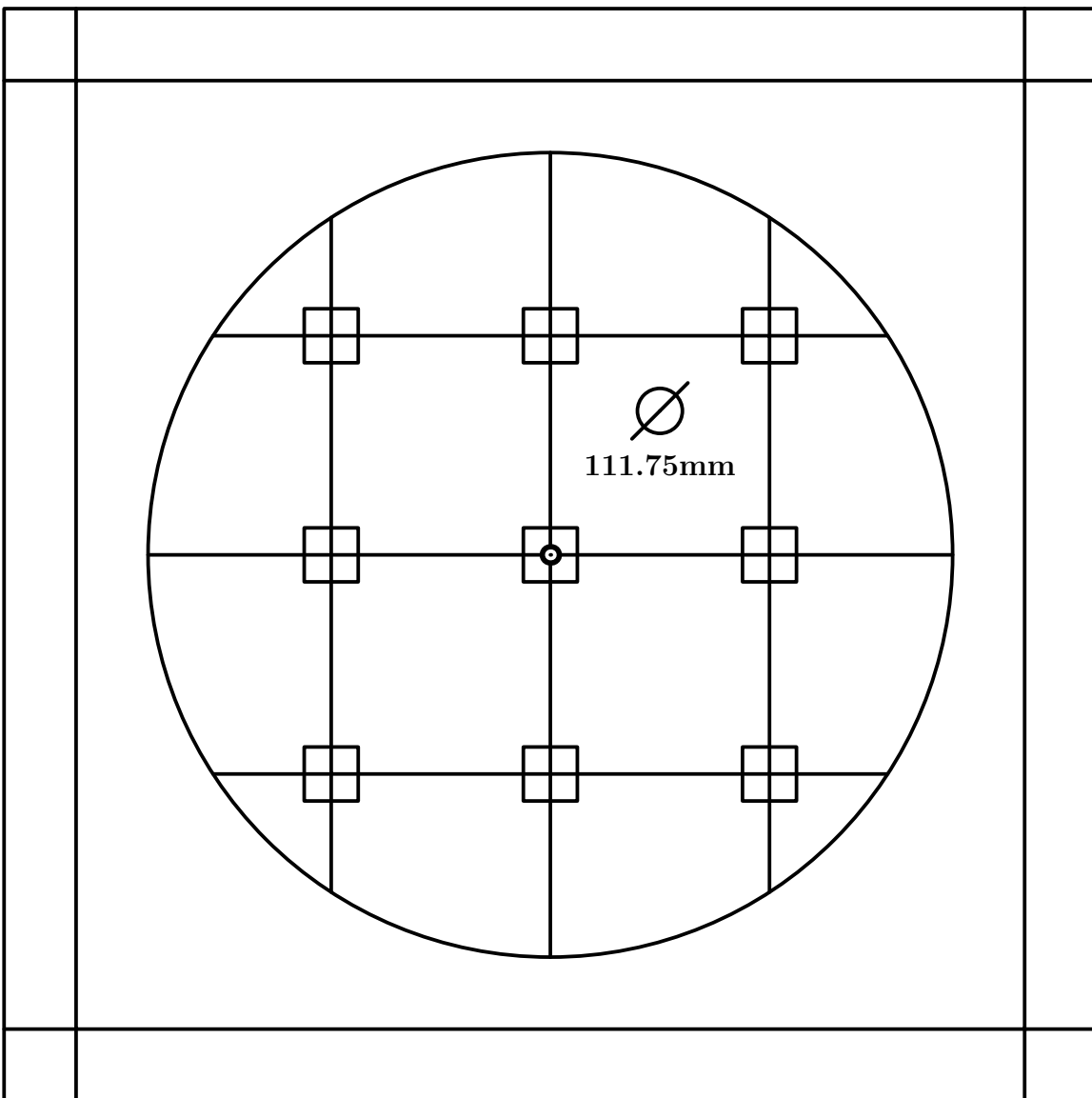

Fig. 48

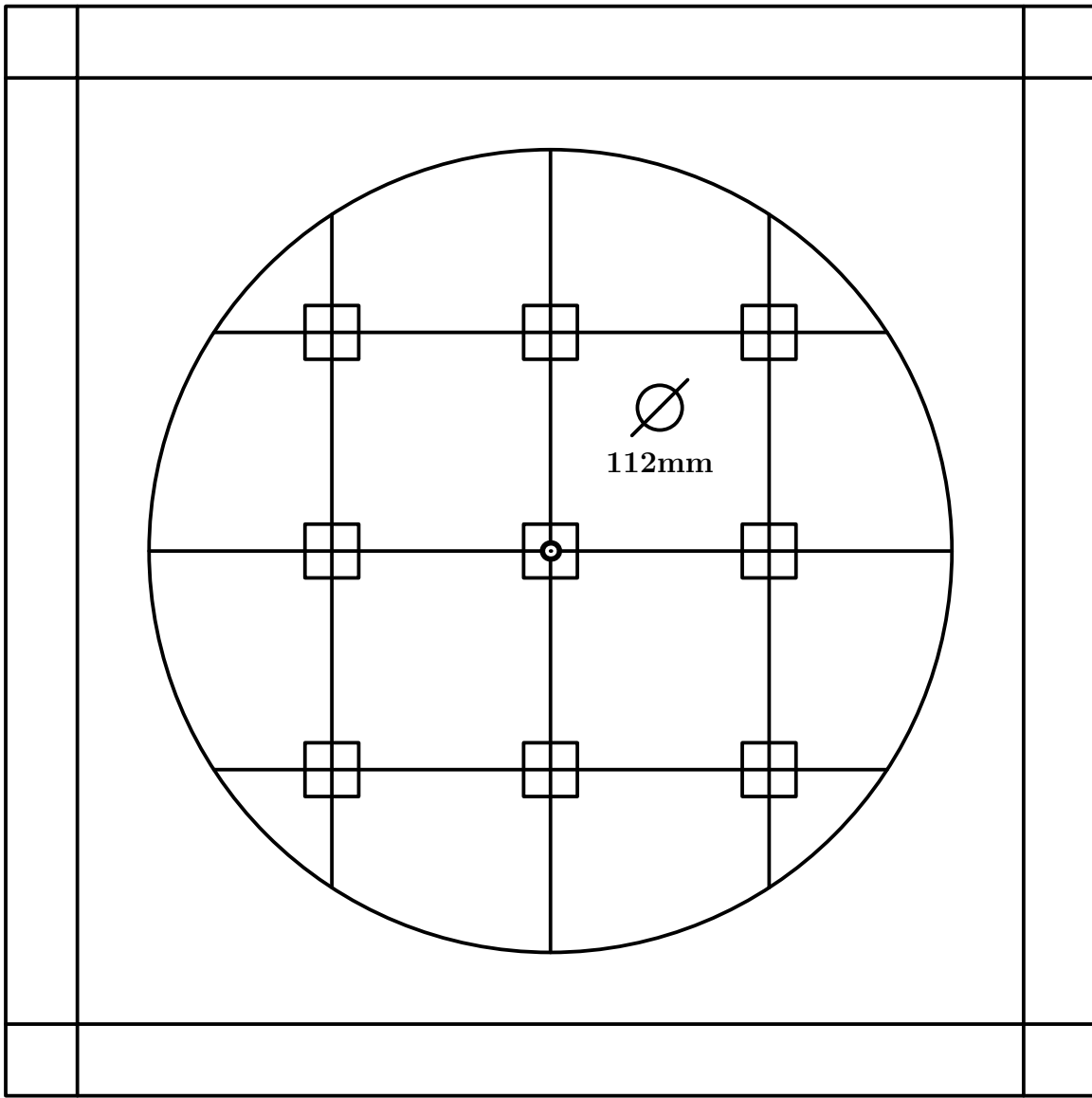

Fig. 49

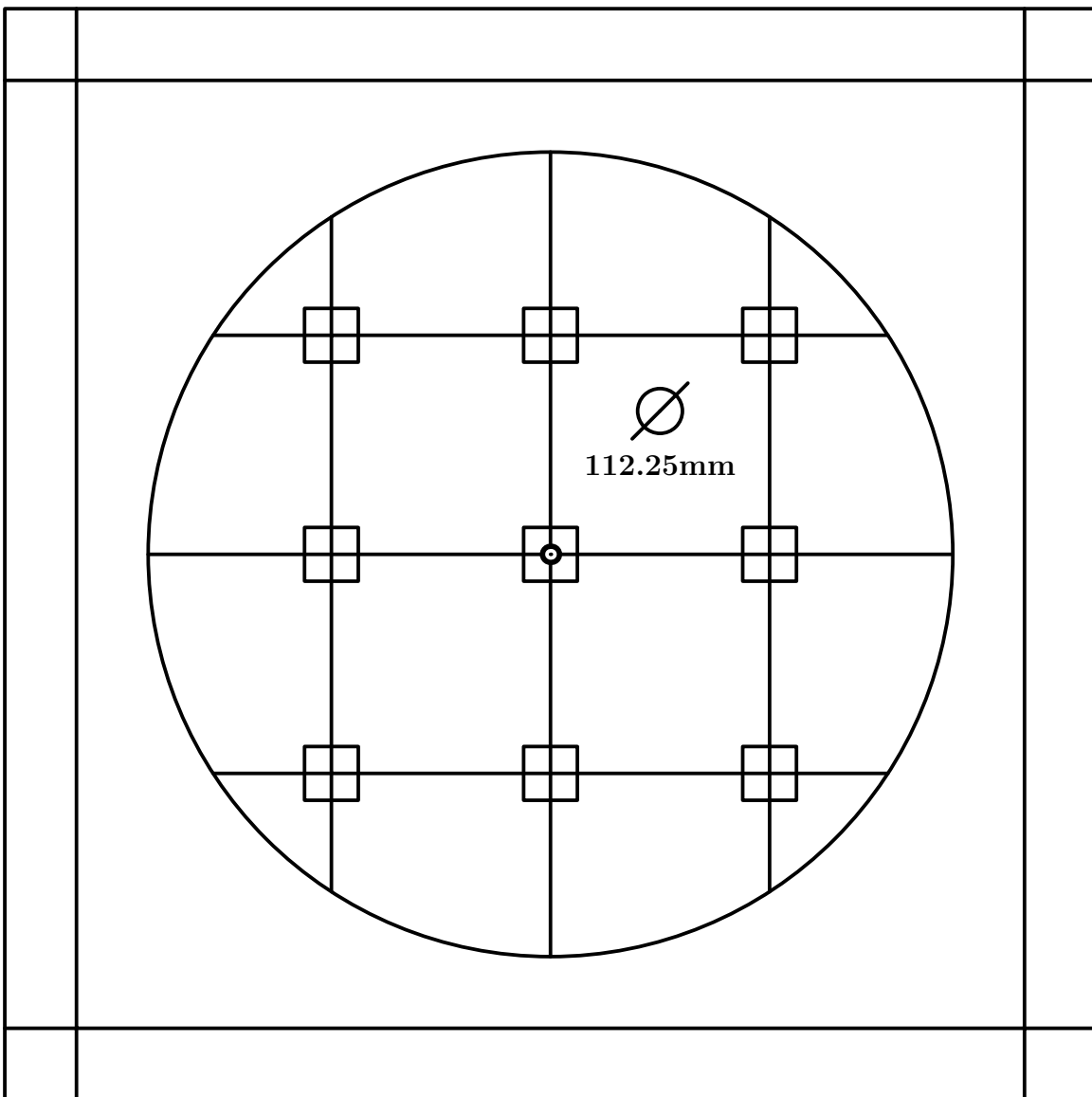

Fig. 50

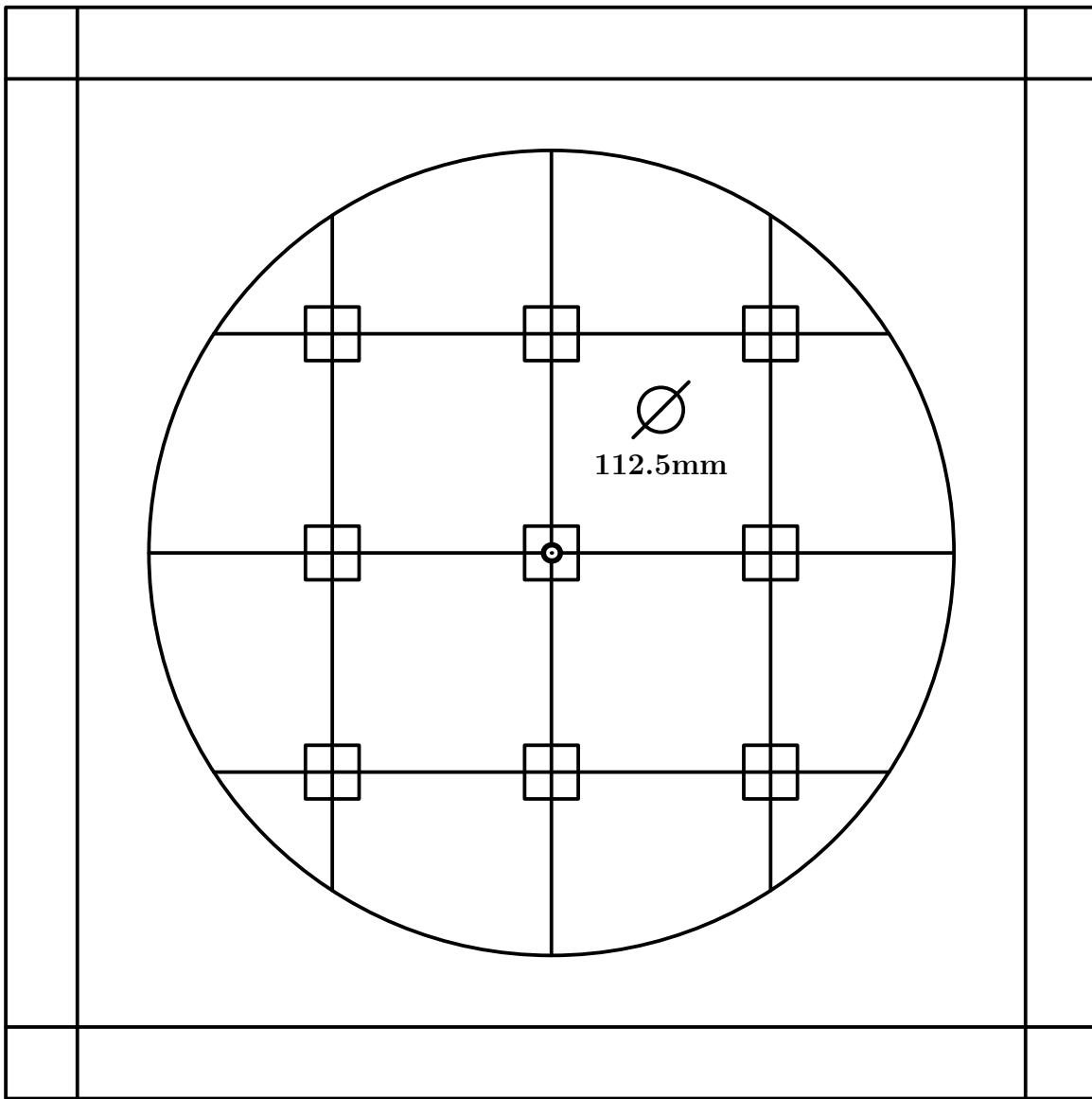

Fig. 51

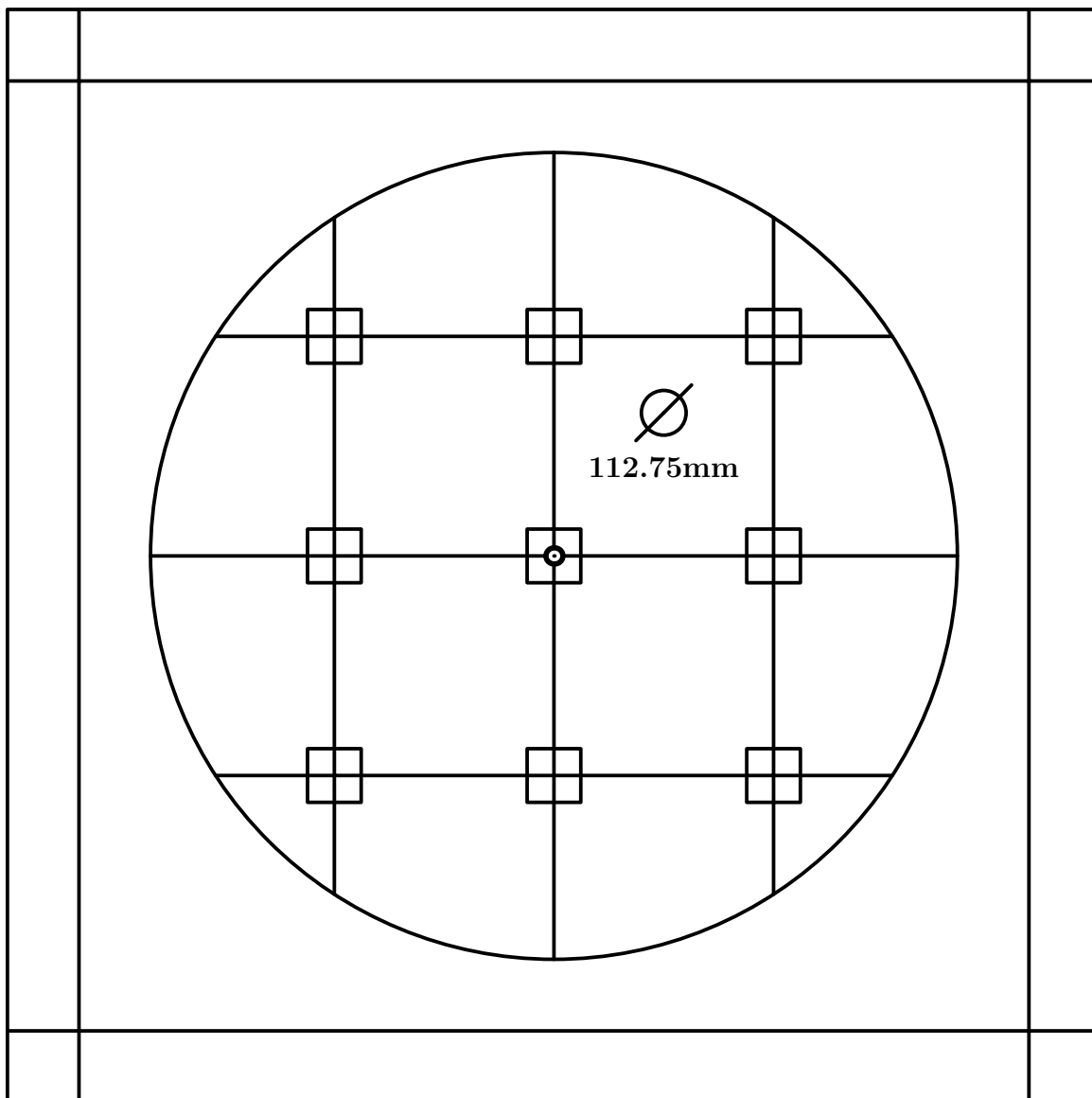

Fig. 52

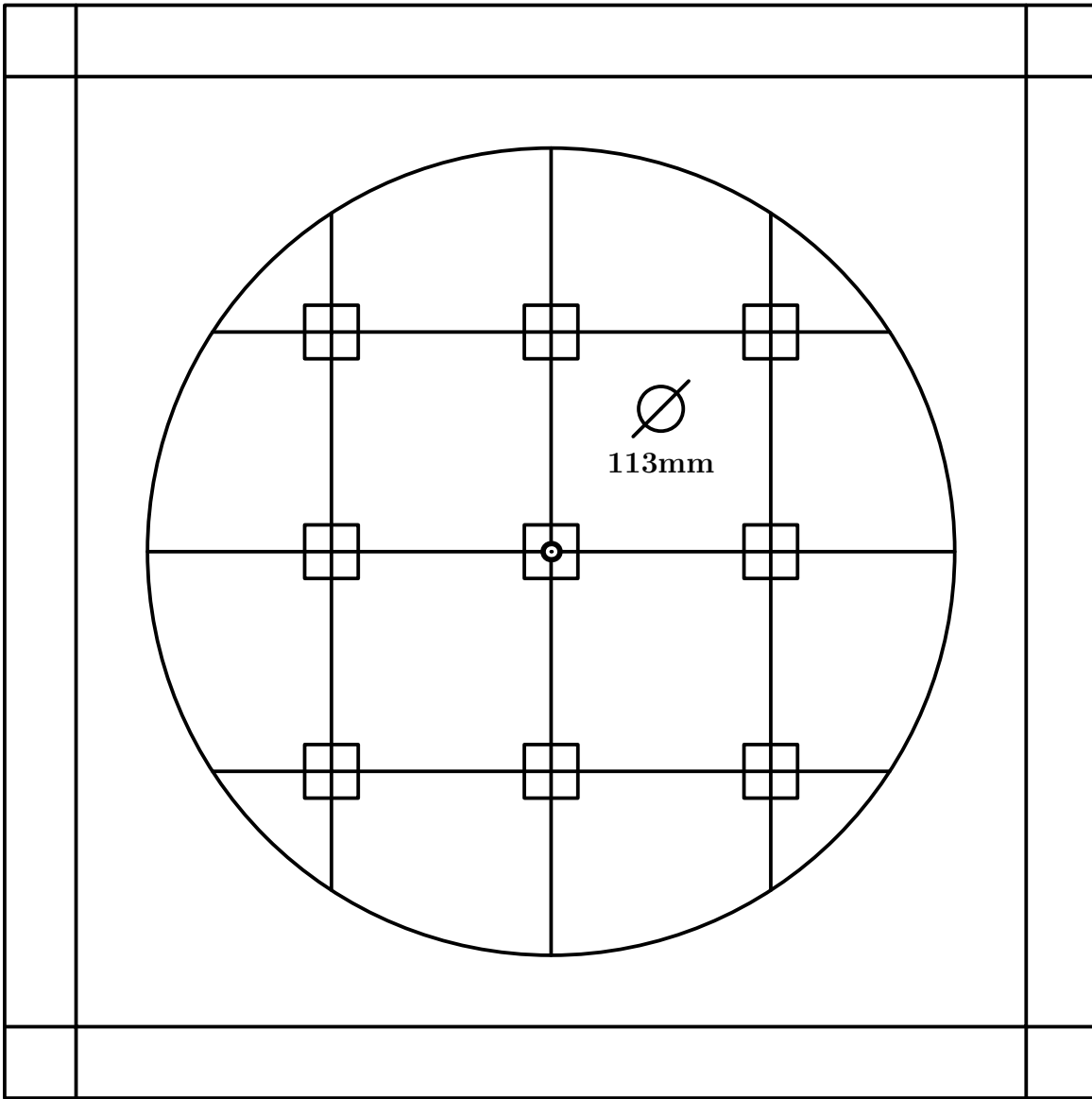

Fig. 53

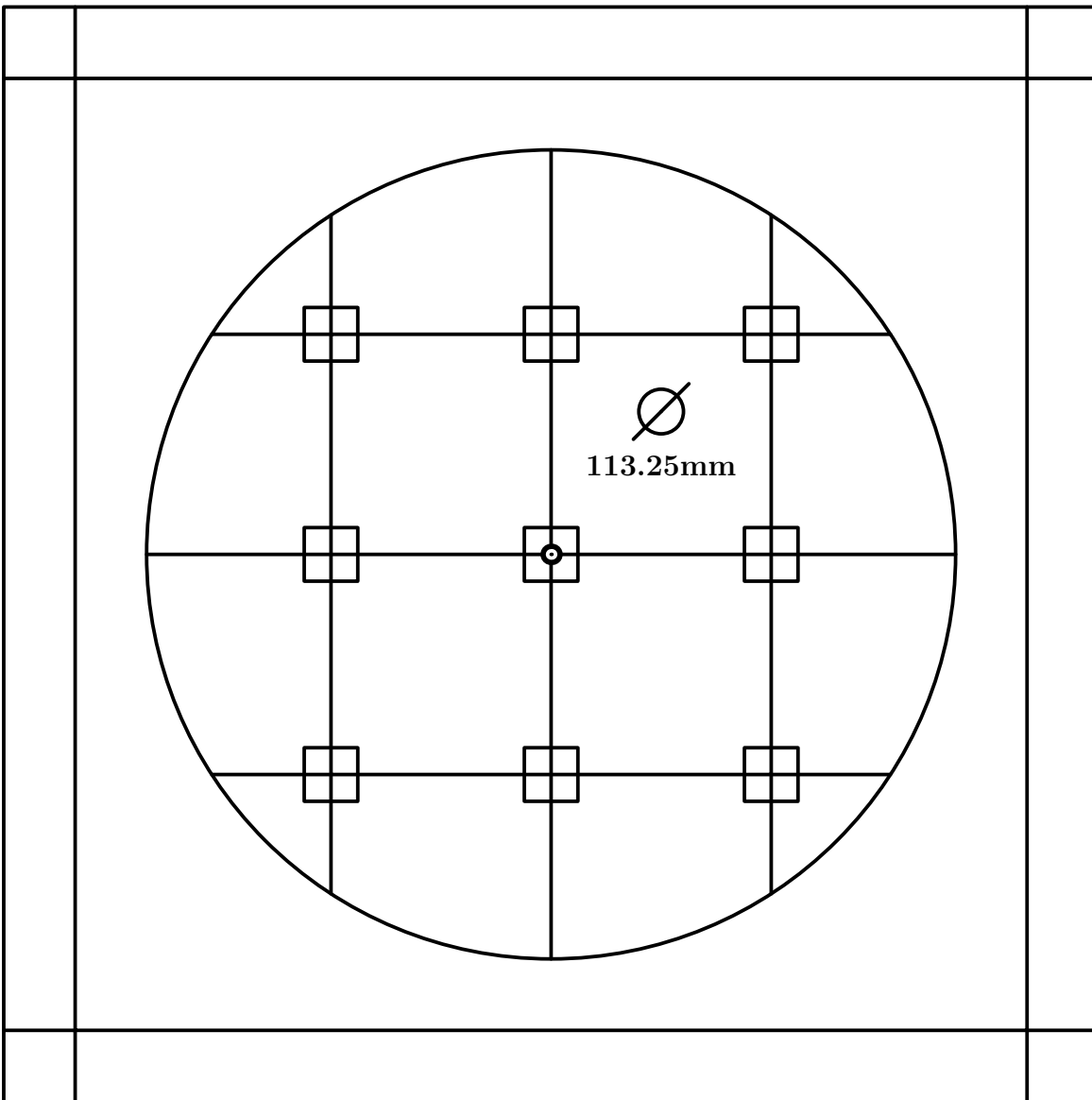

Fig. 54

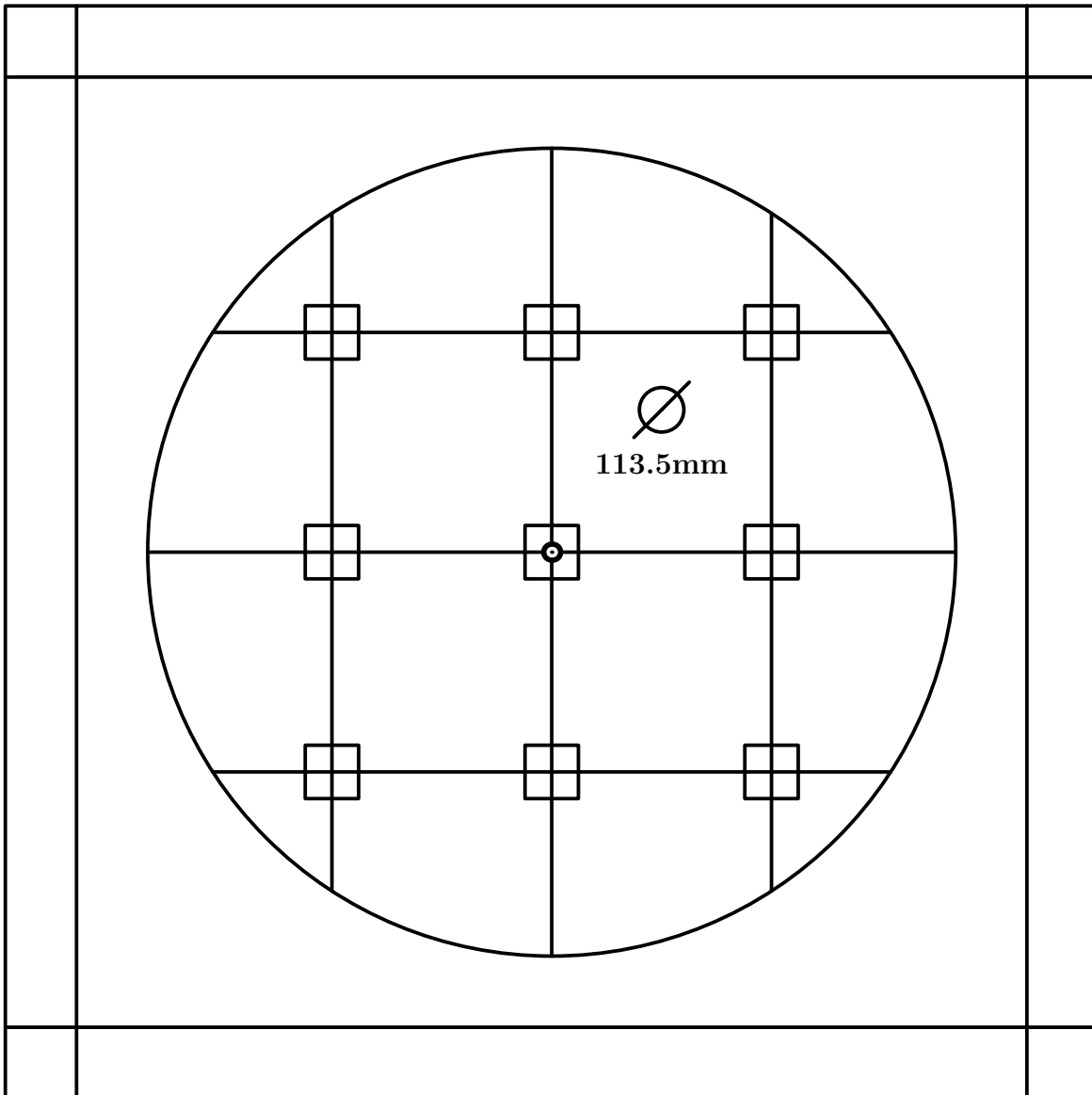

Fig. 55

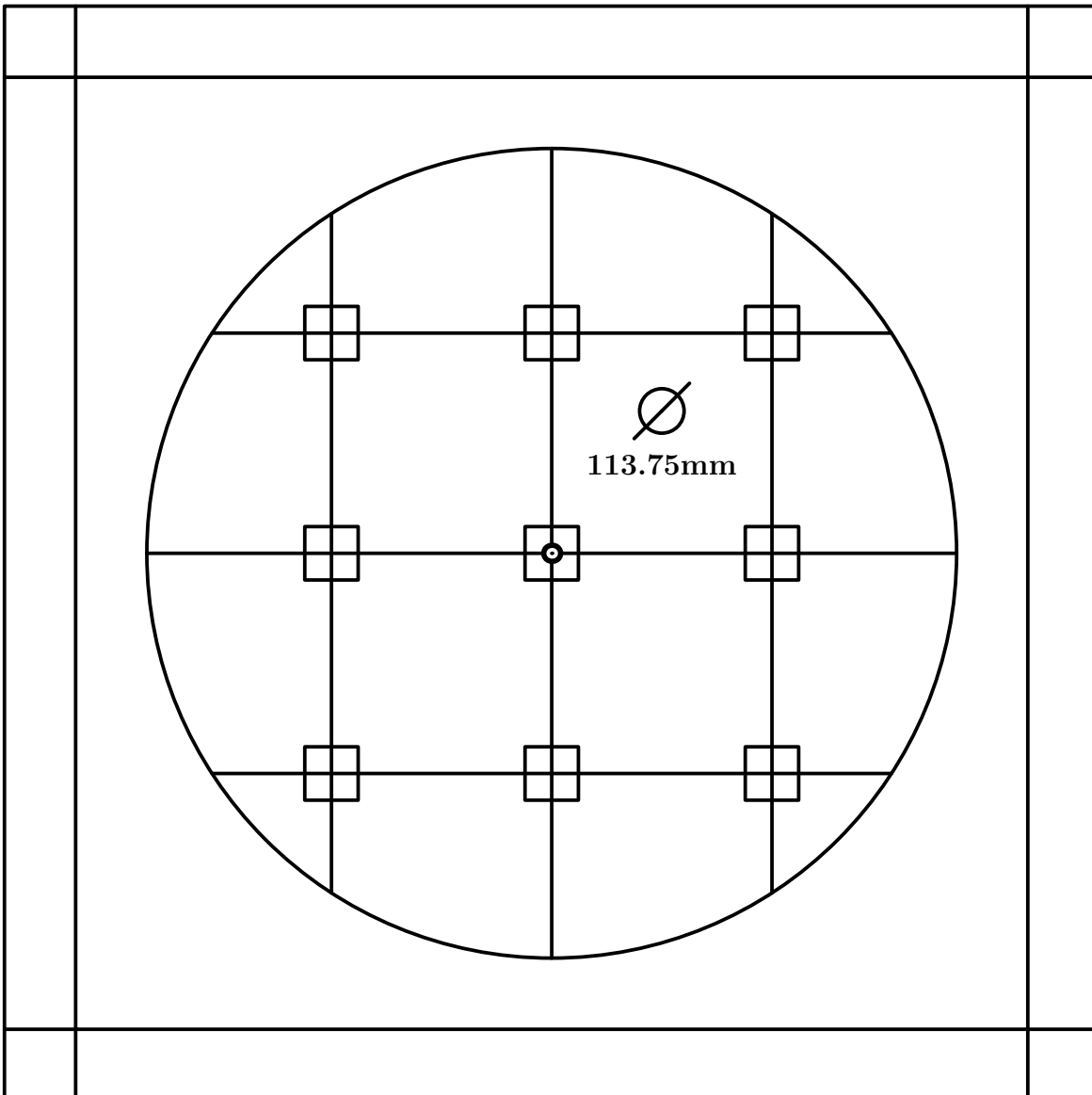

Fig. 56

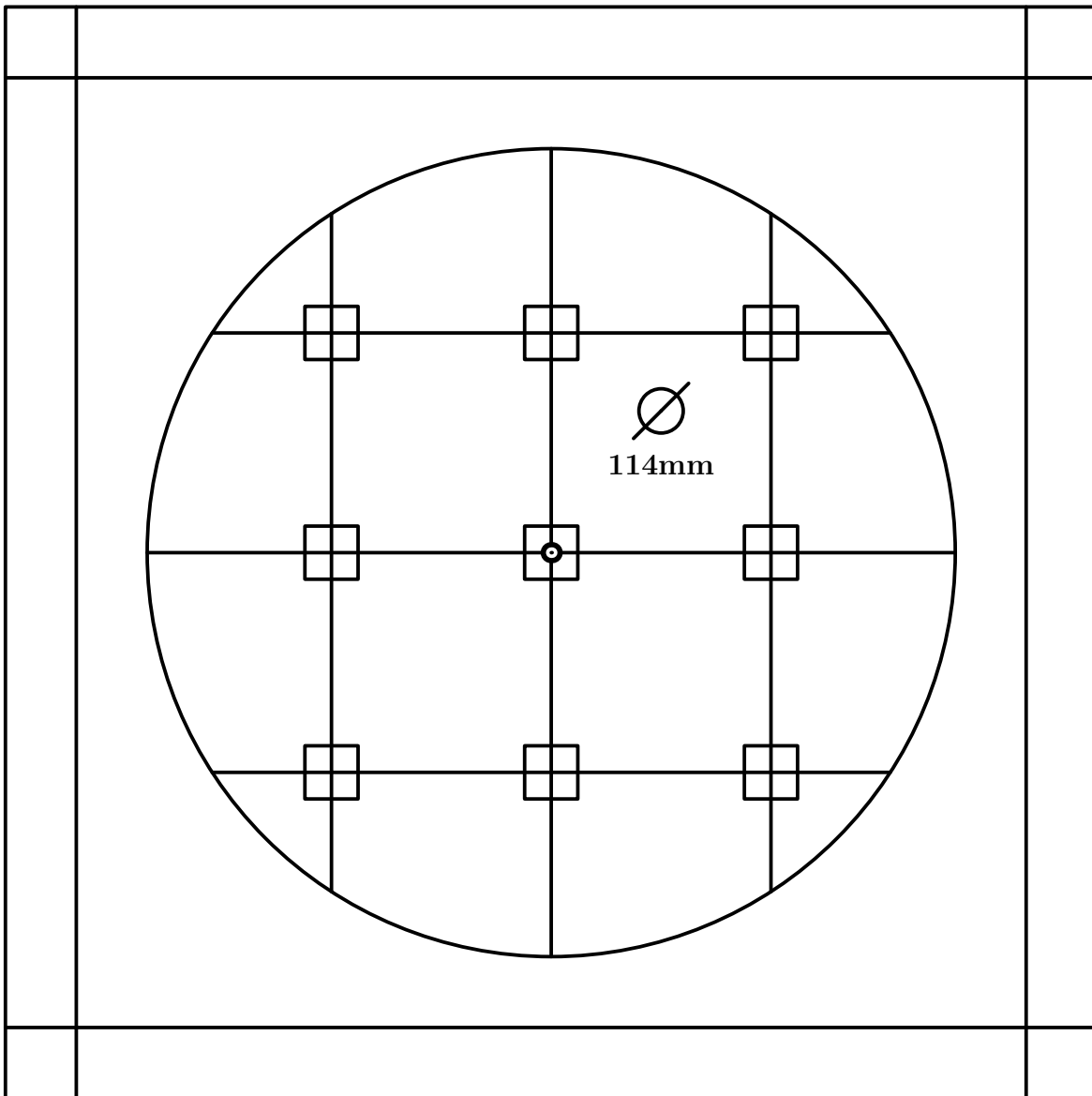

Fig. 57

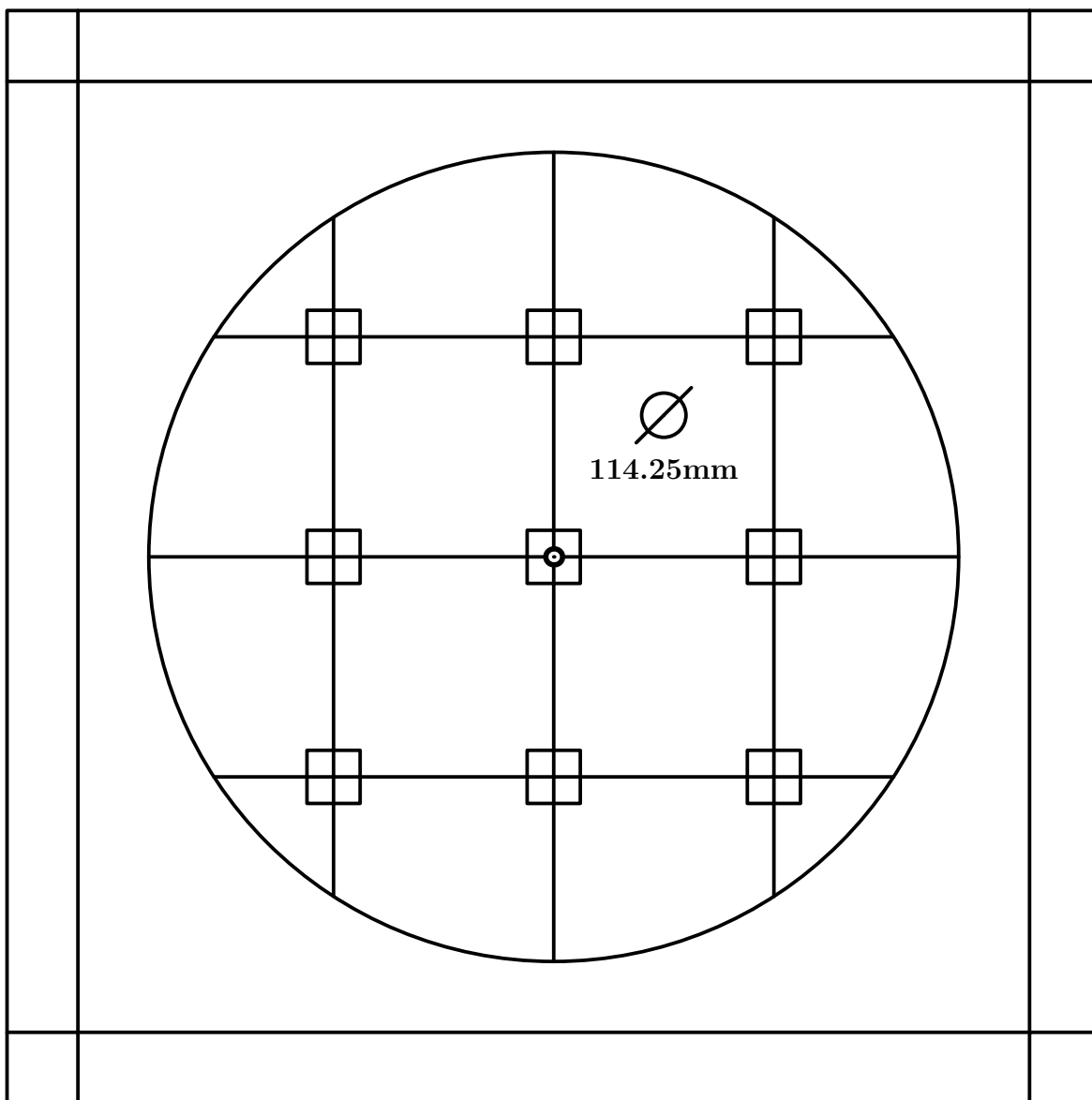

Fig. 58

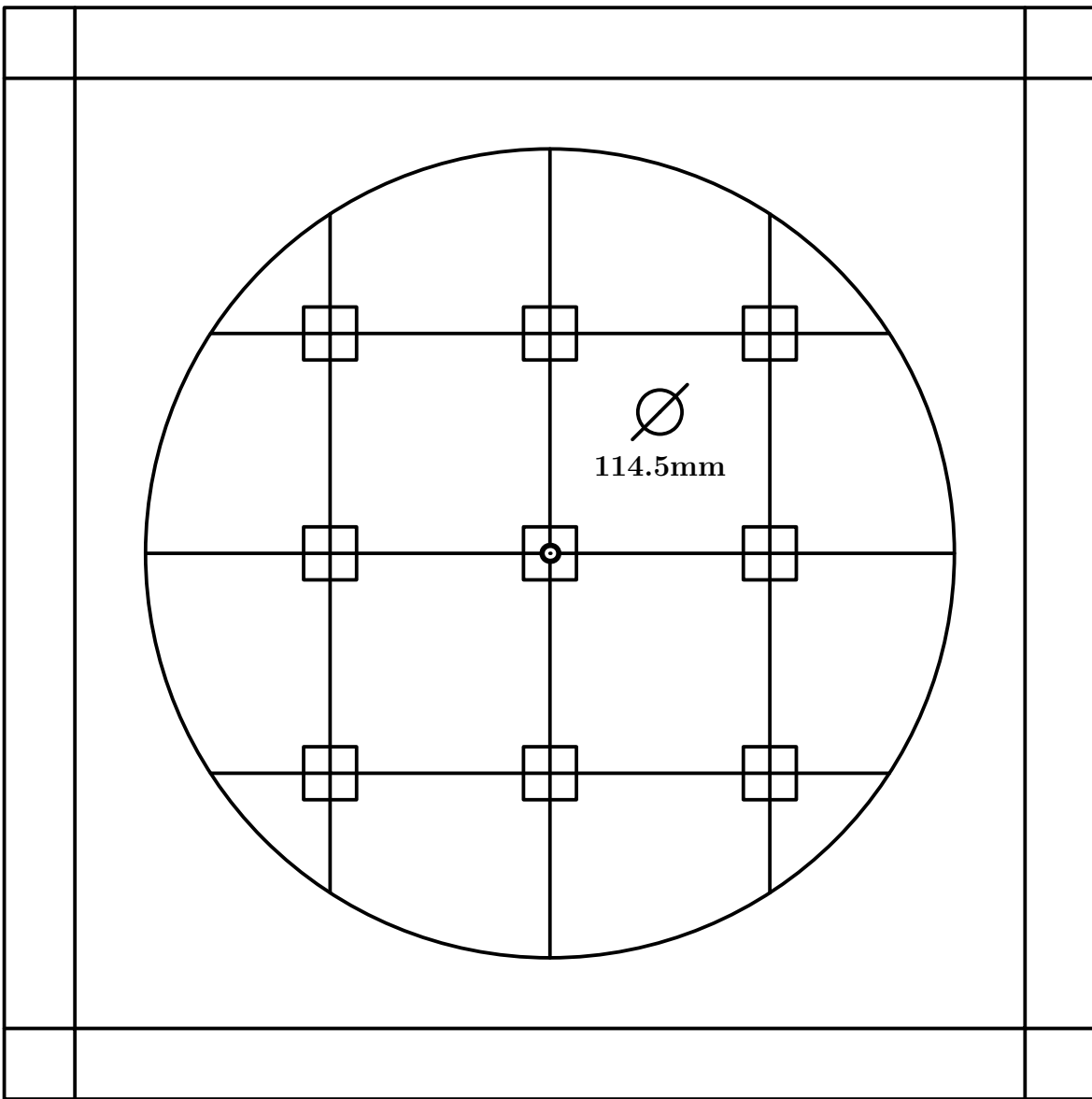

Fig. 59

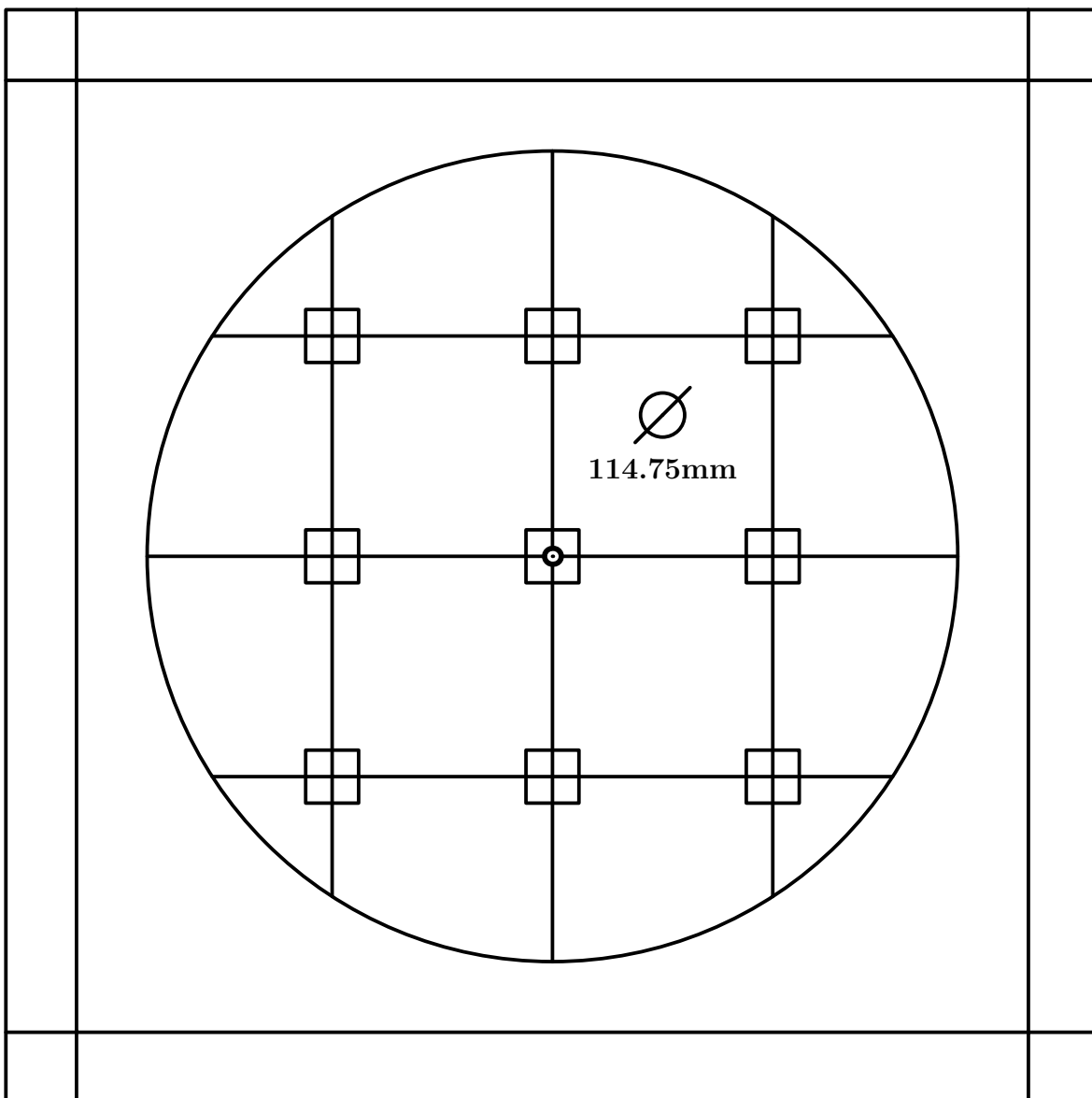

Fig. 60

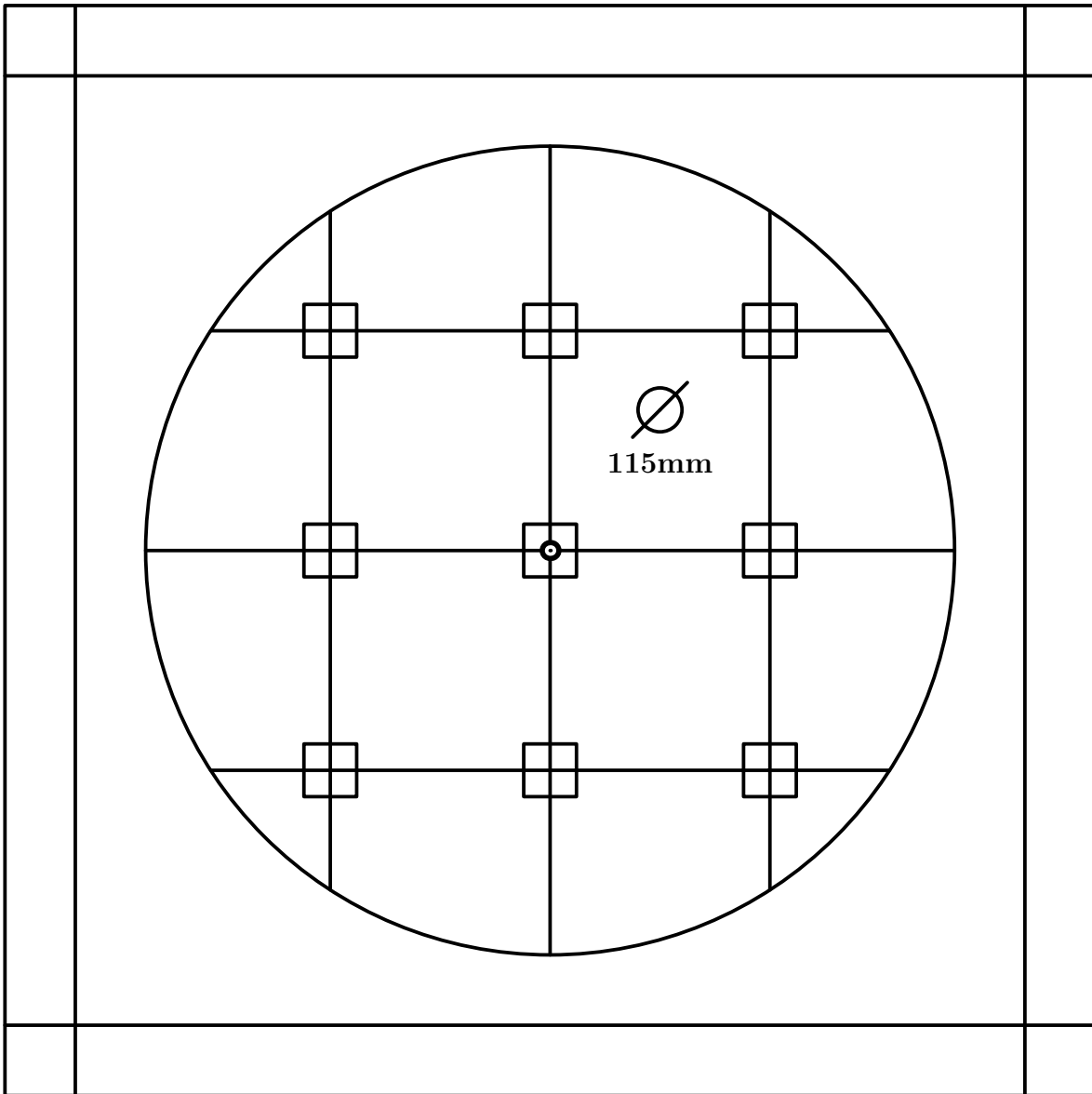

Fig. 61

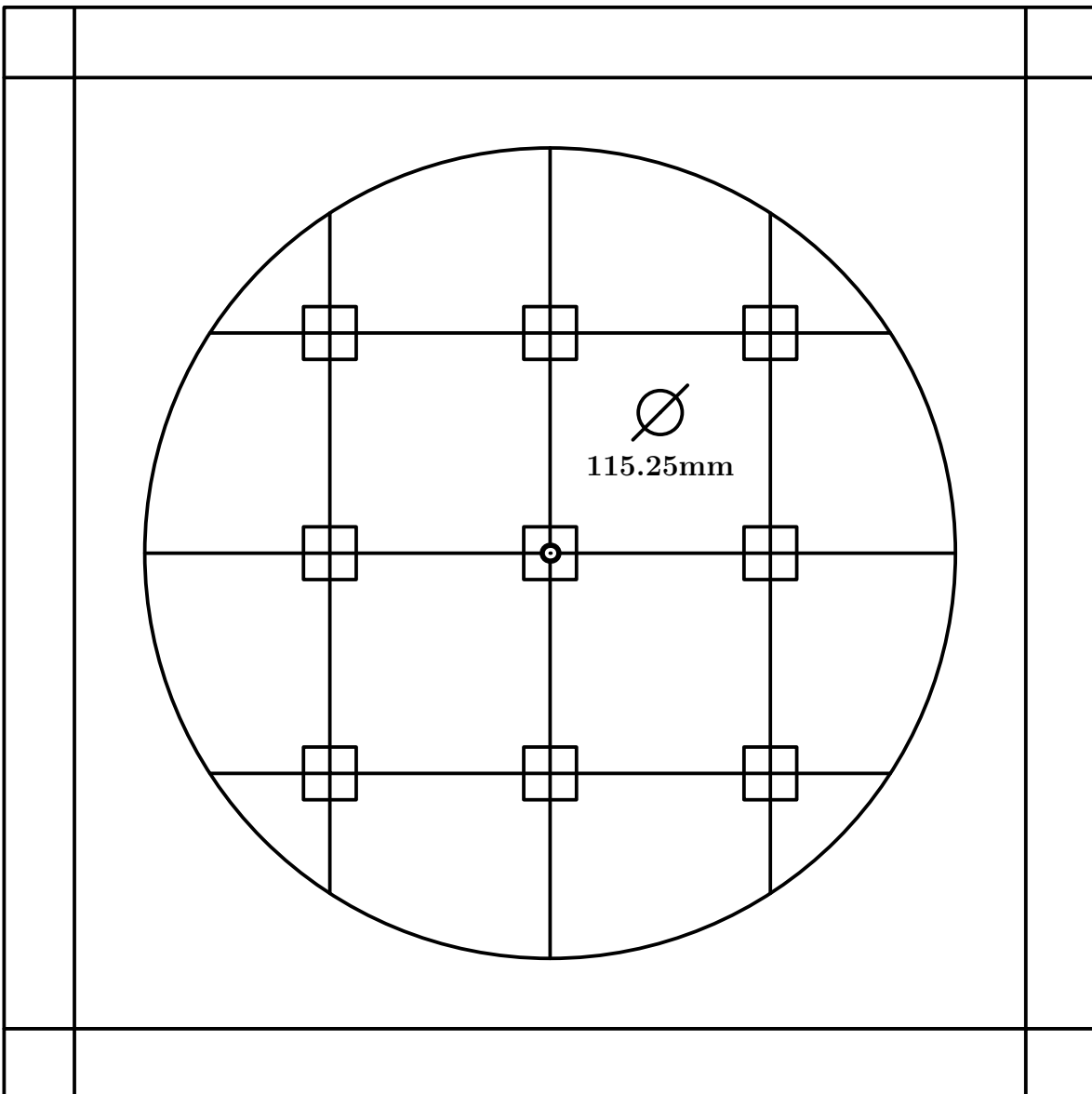

Fig. 62

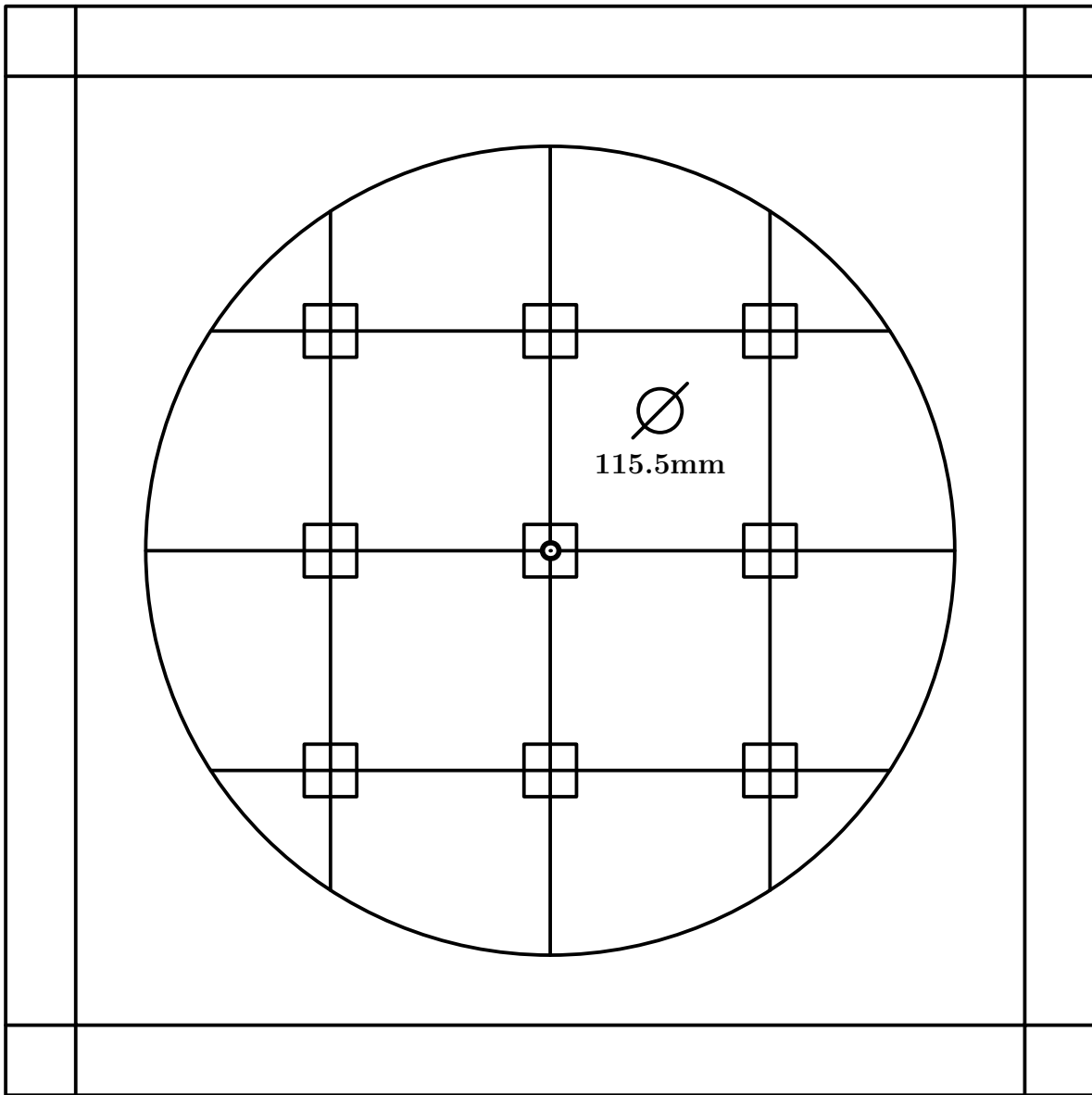

Fig. 63

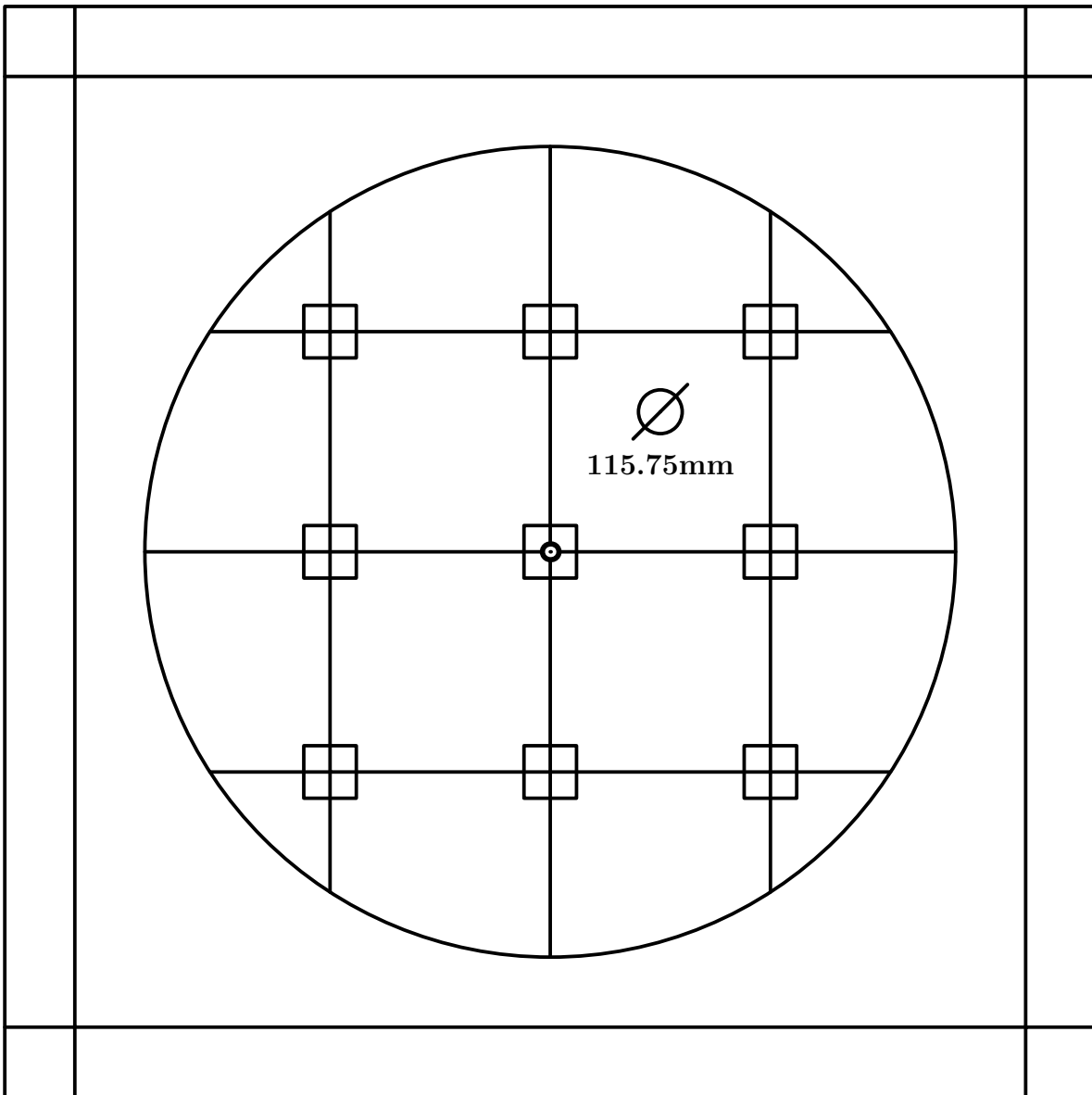

Fig. 64

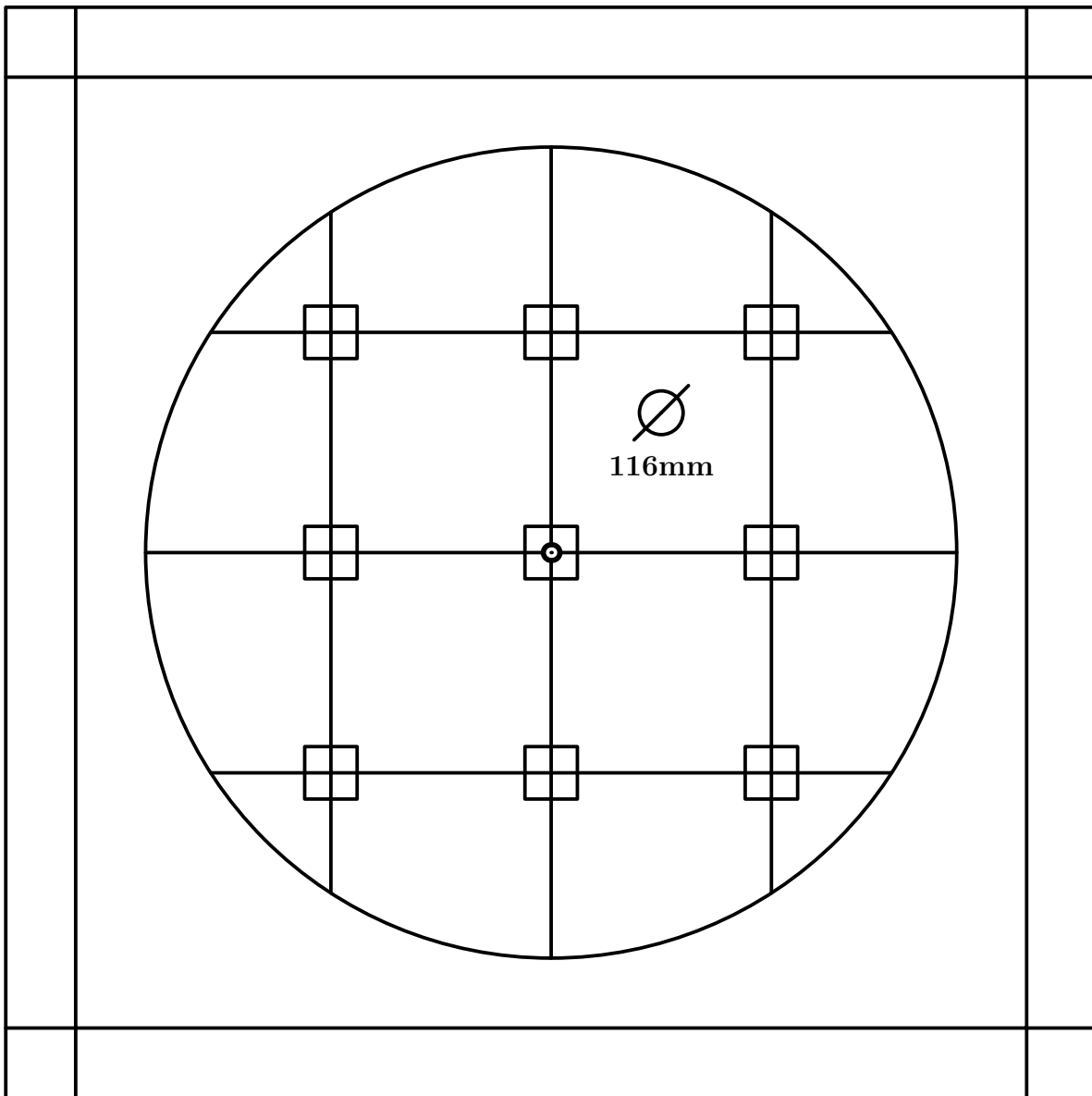

Fig. 65

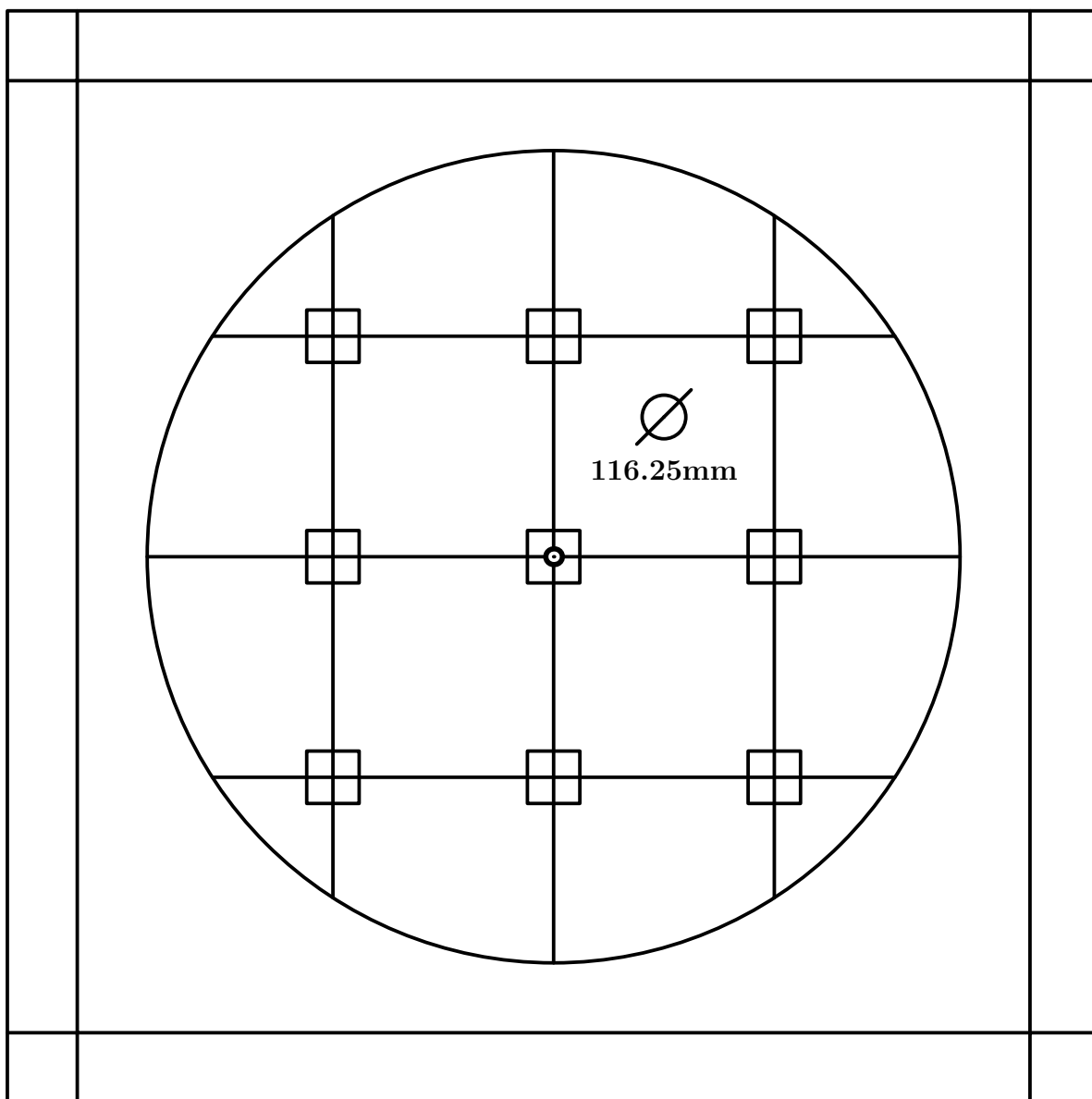

Fig. 66

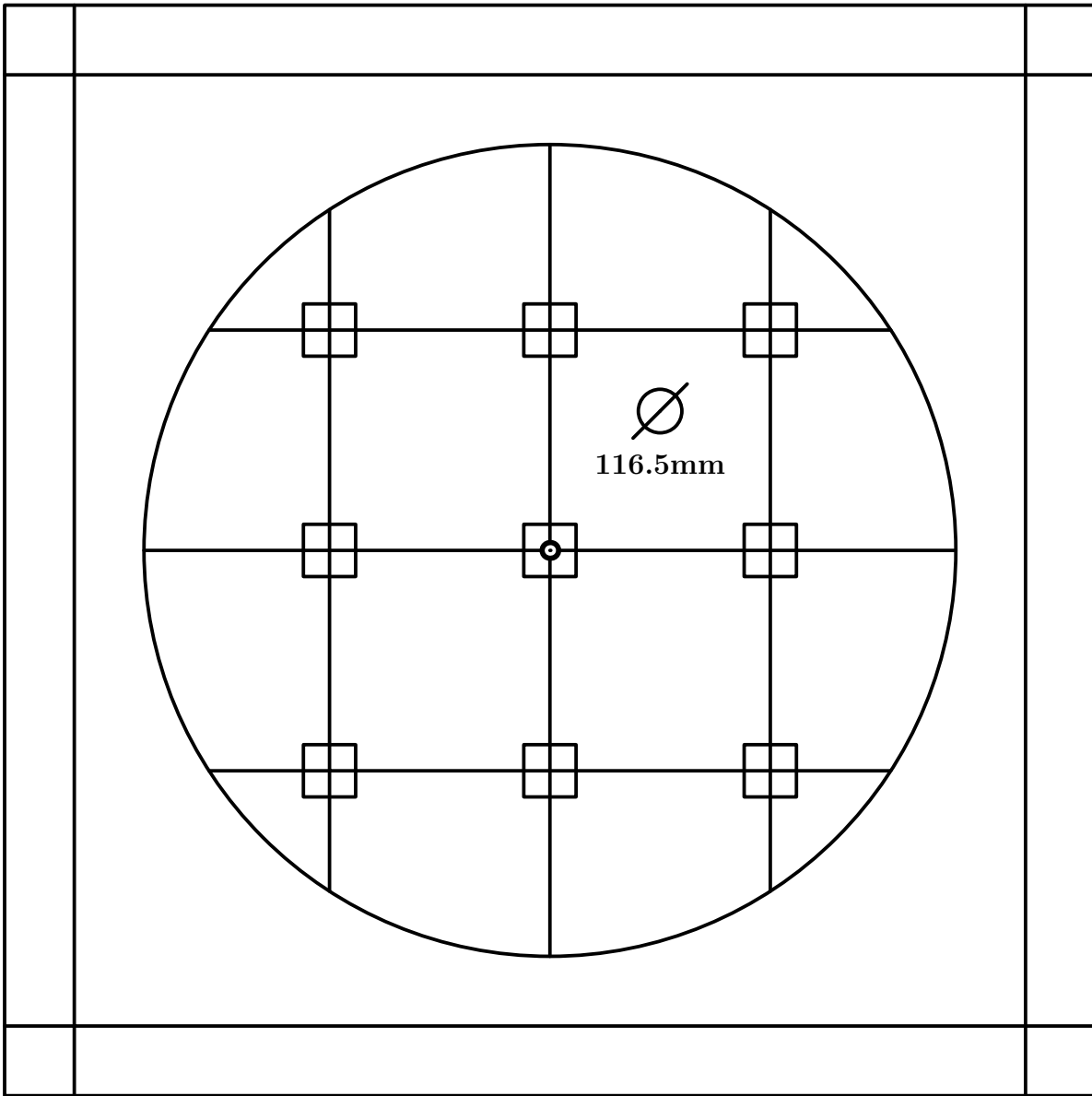

Fig. 67

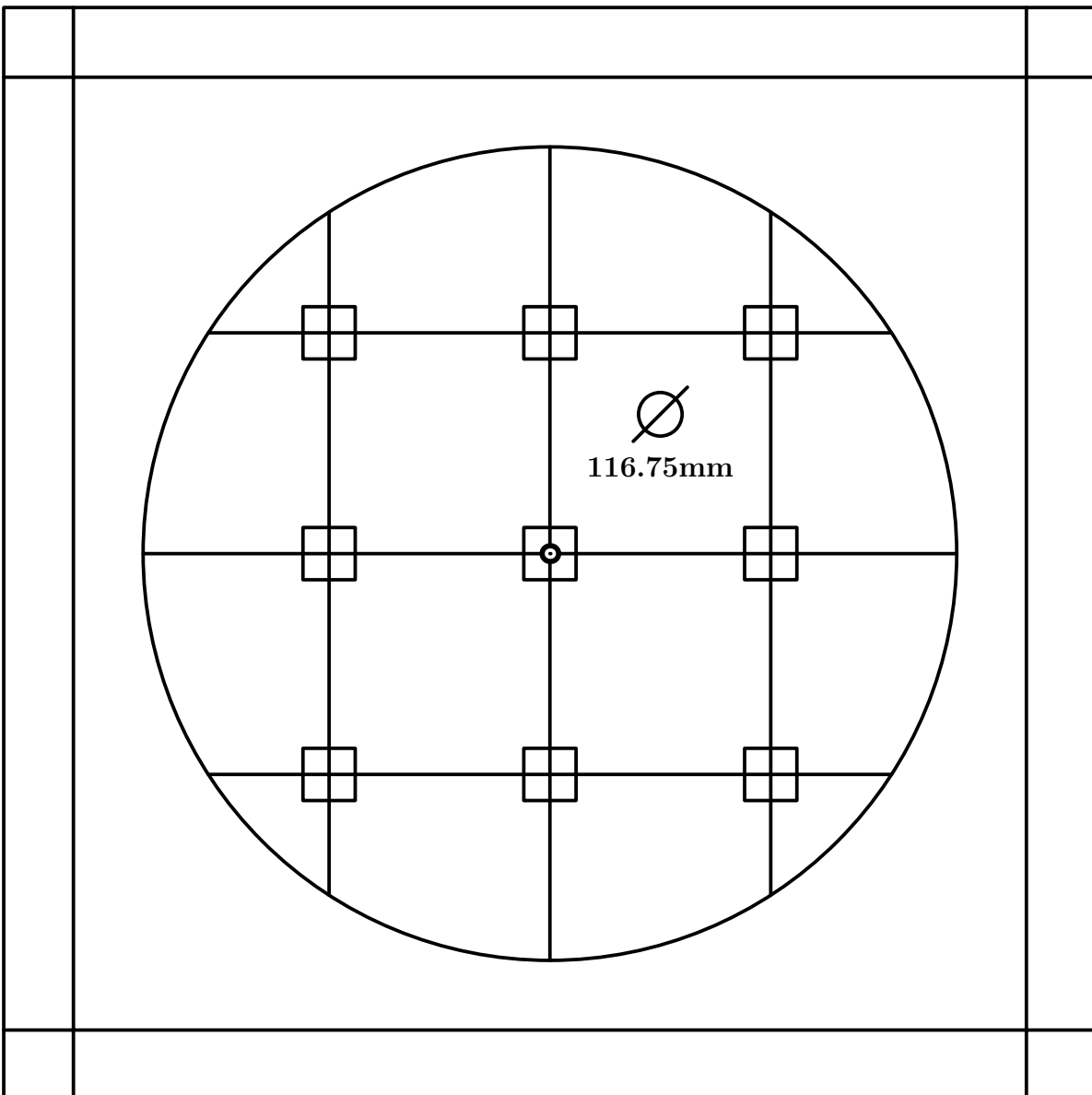

Fig. 68

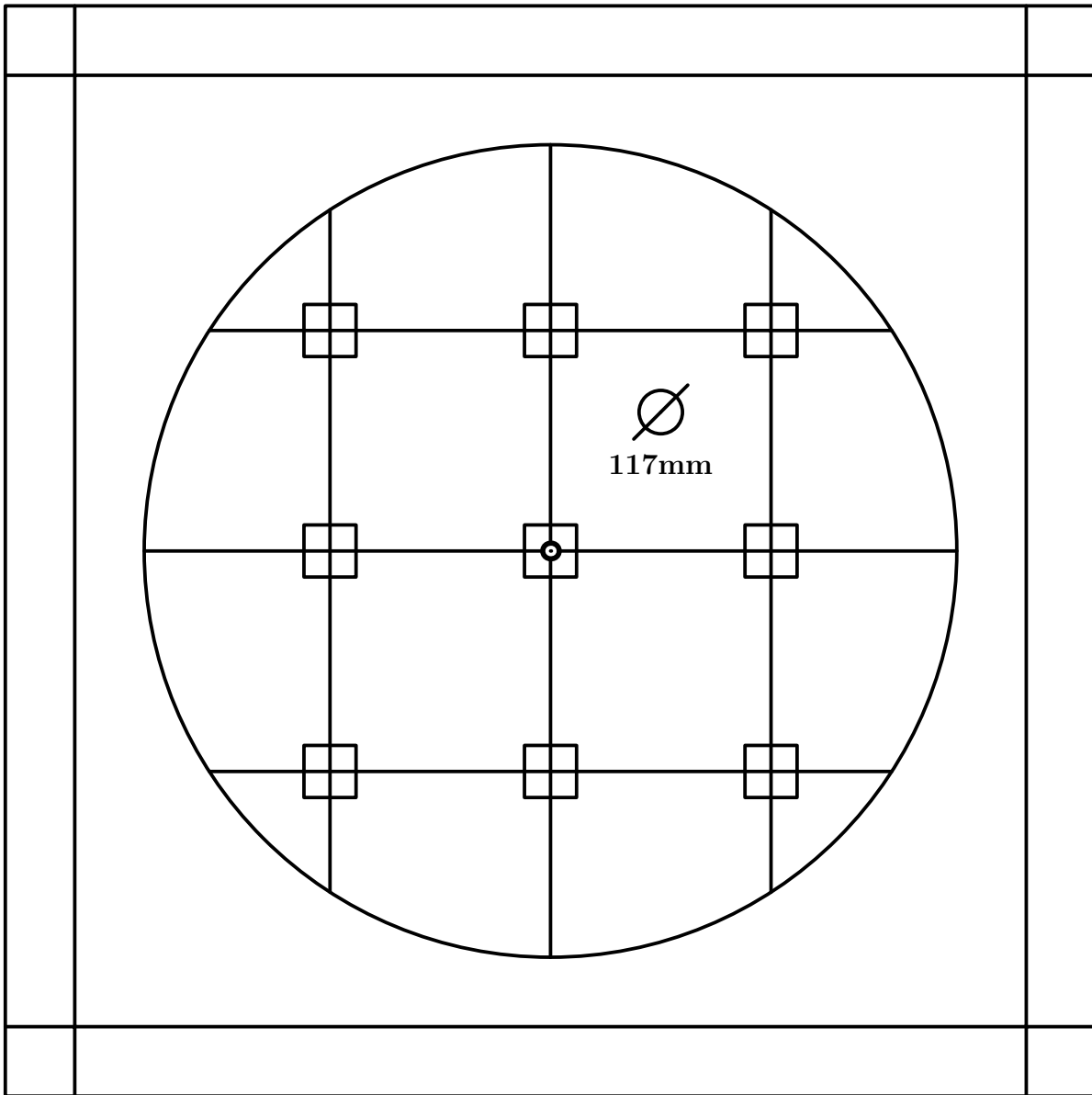

Fig. 69

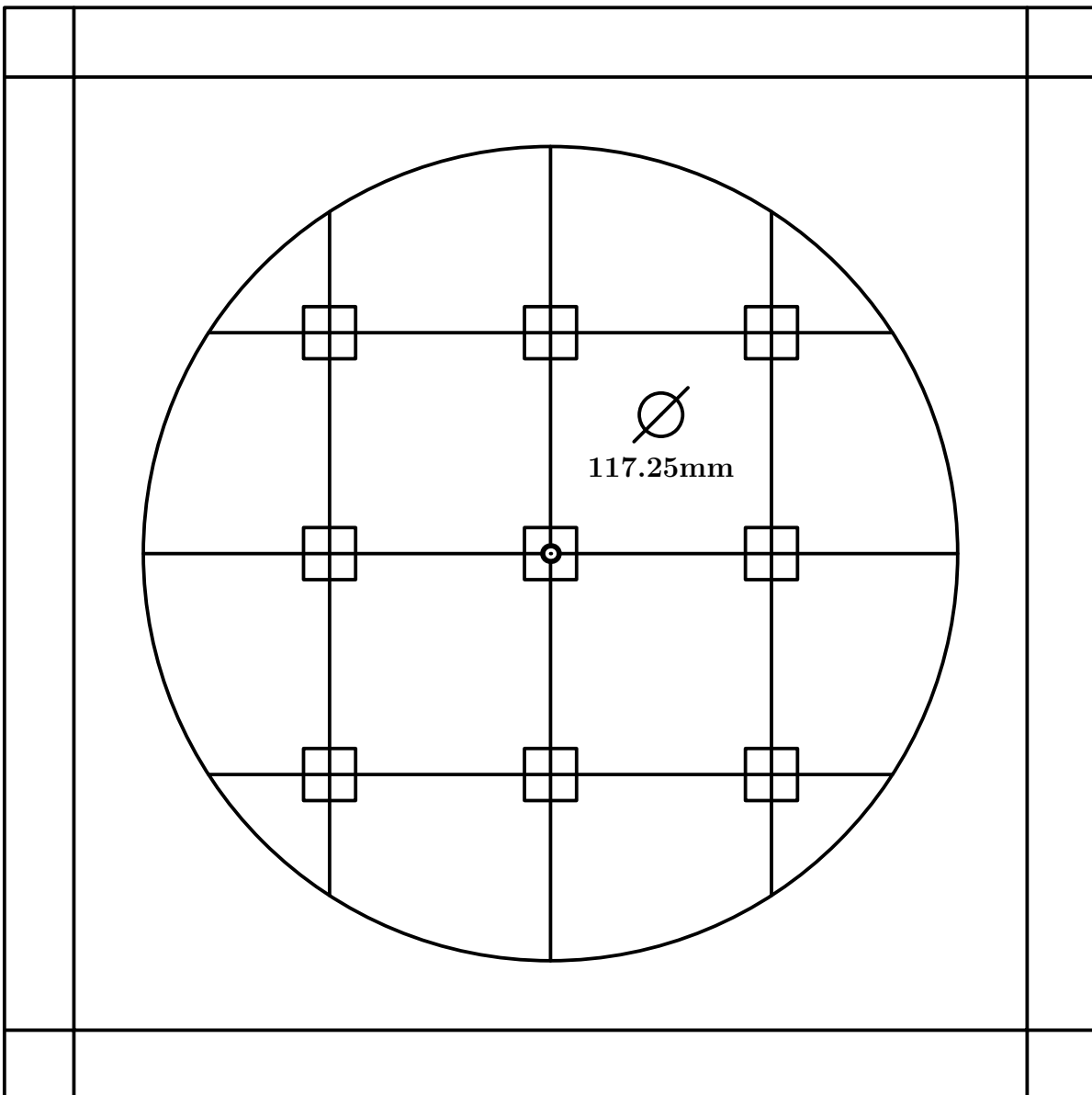

Fig. 70

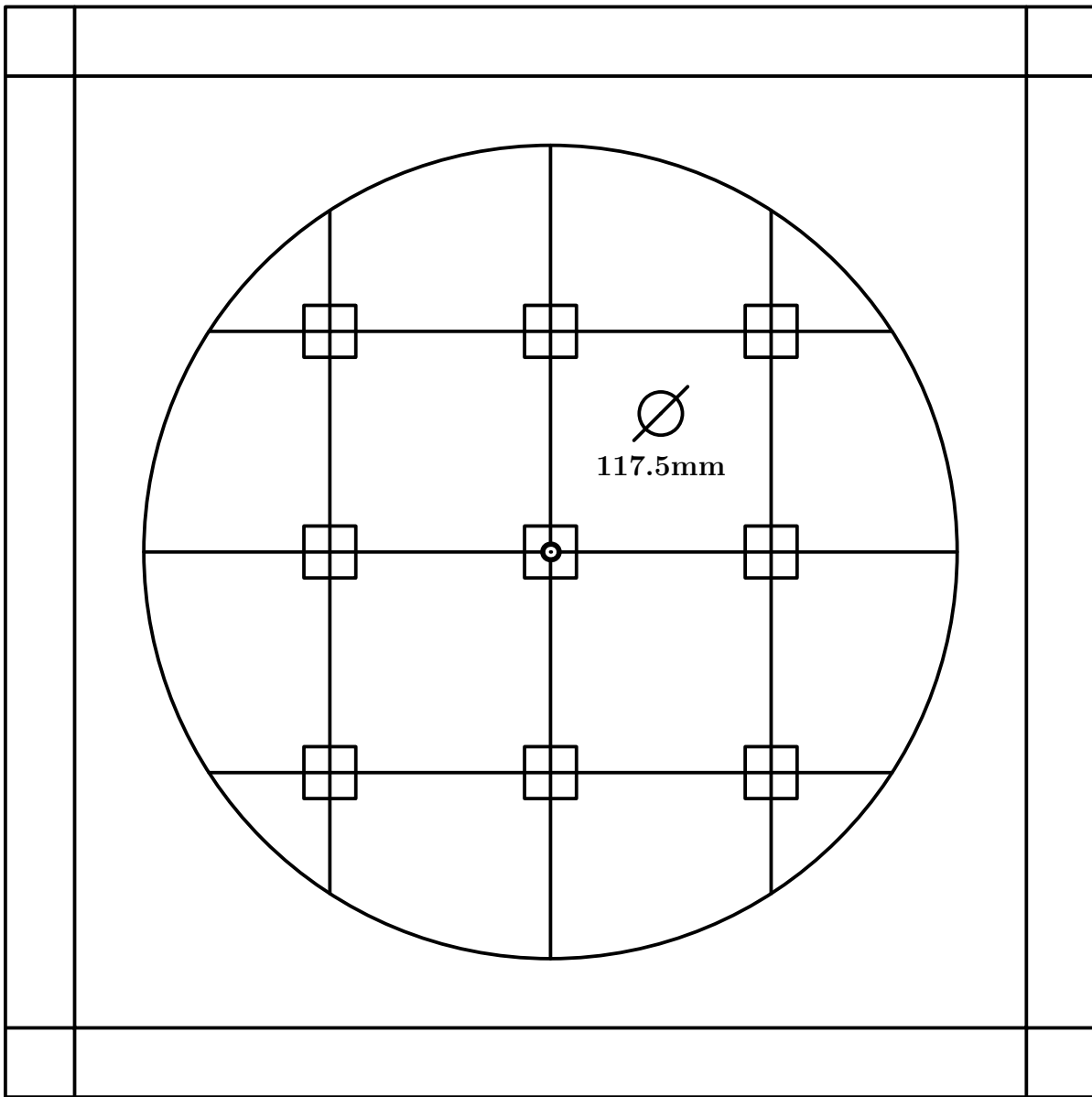

Fig. 71

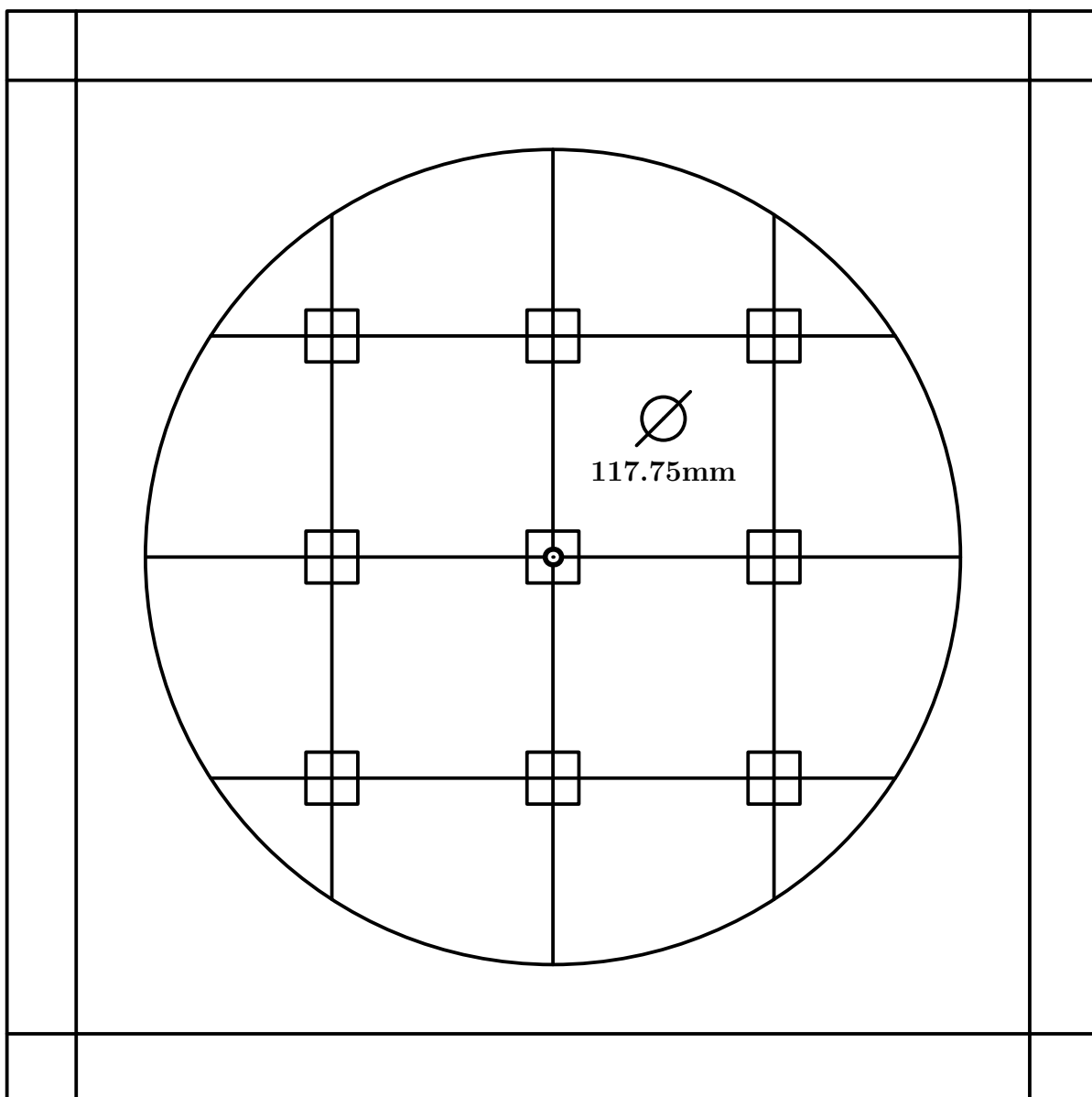

Fig. 72

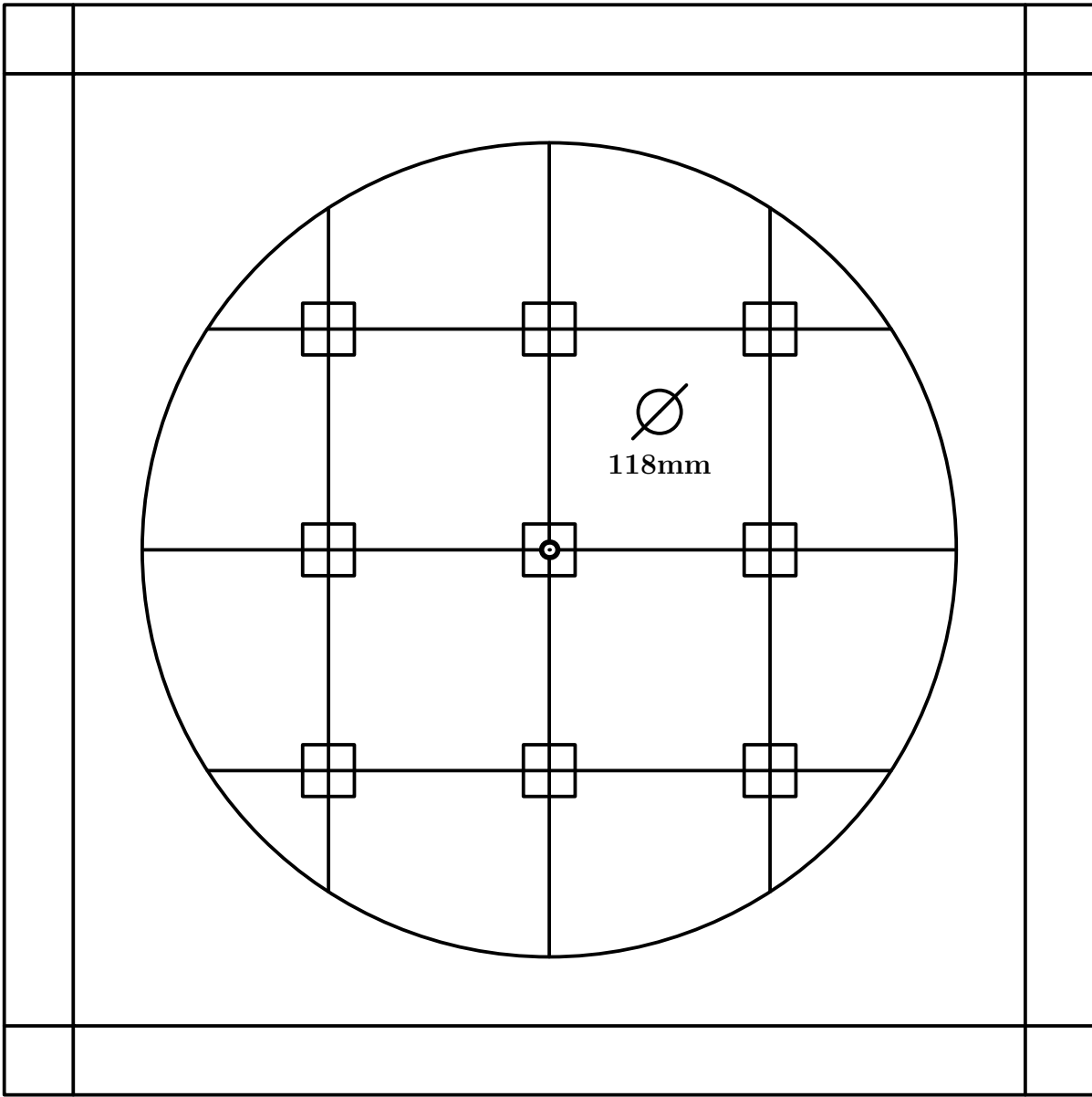

Fig. 73

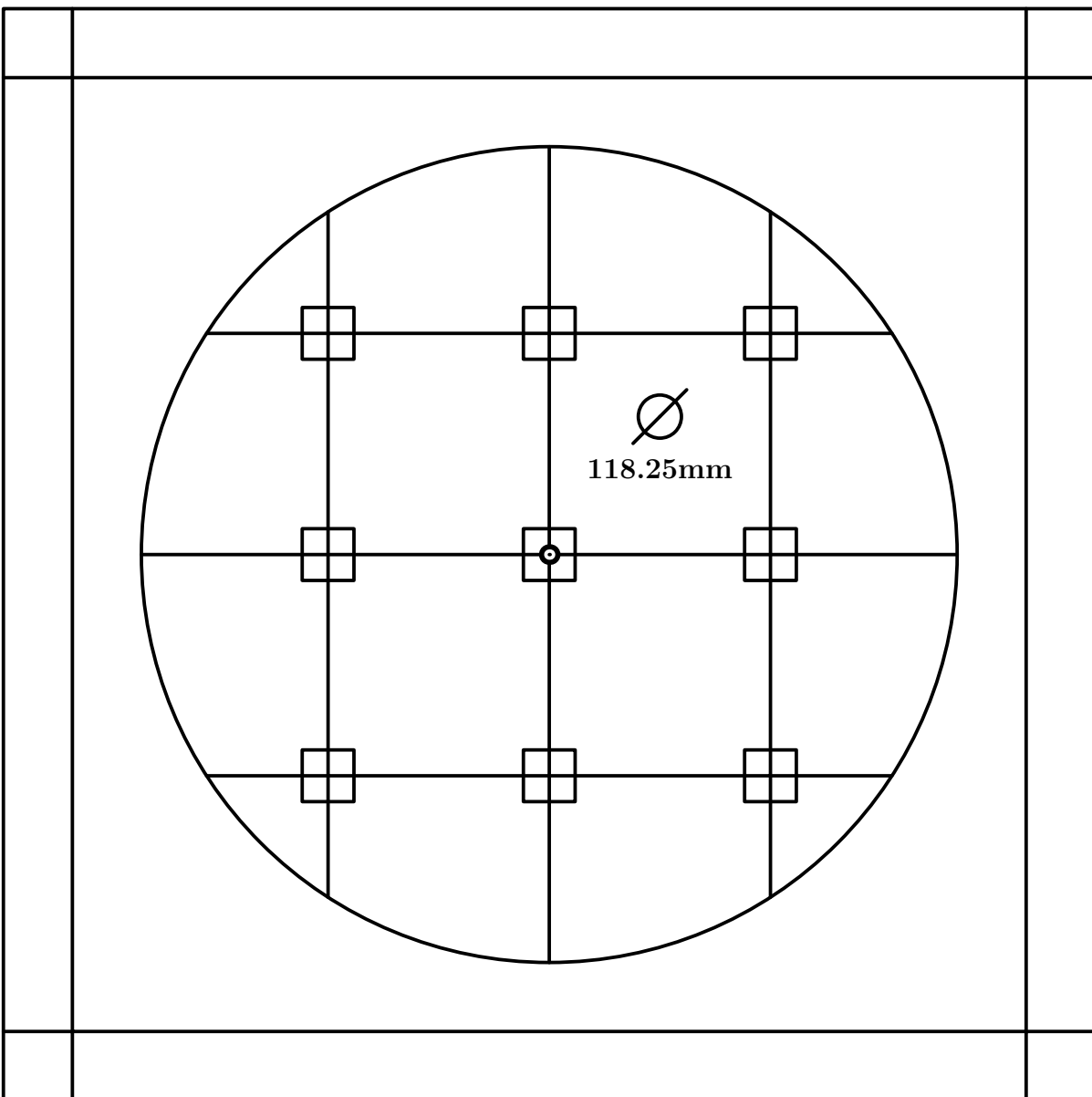

Fig. 74

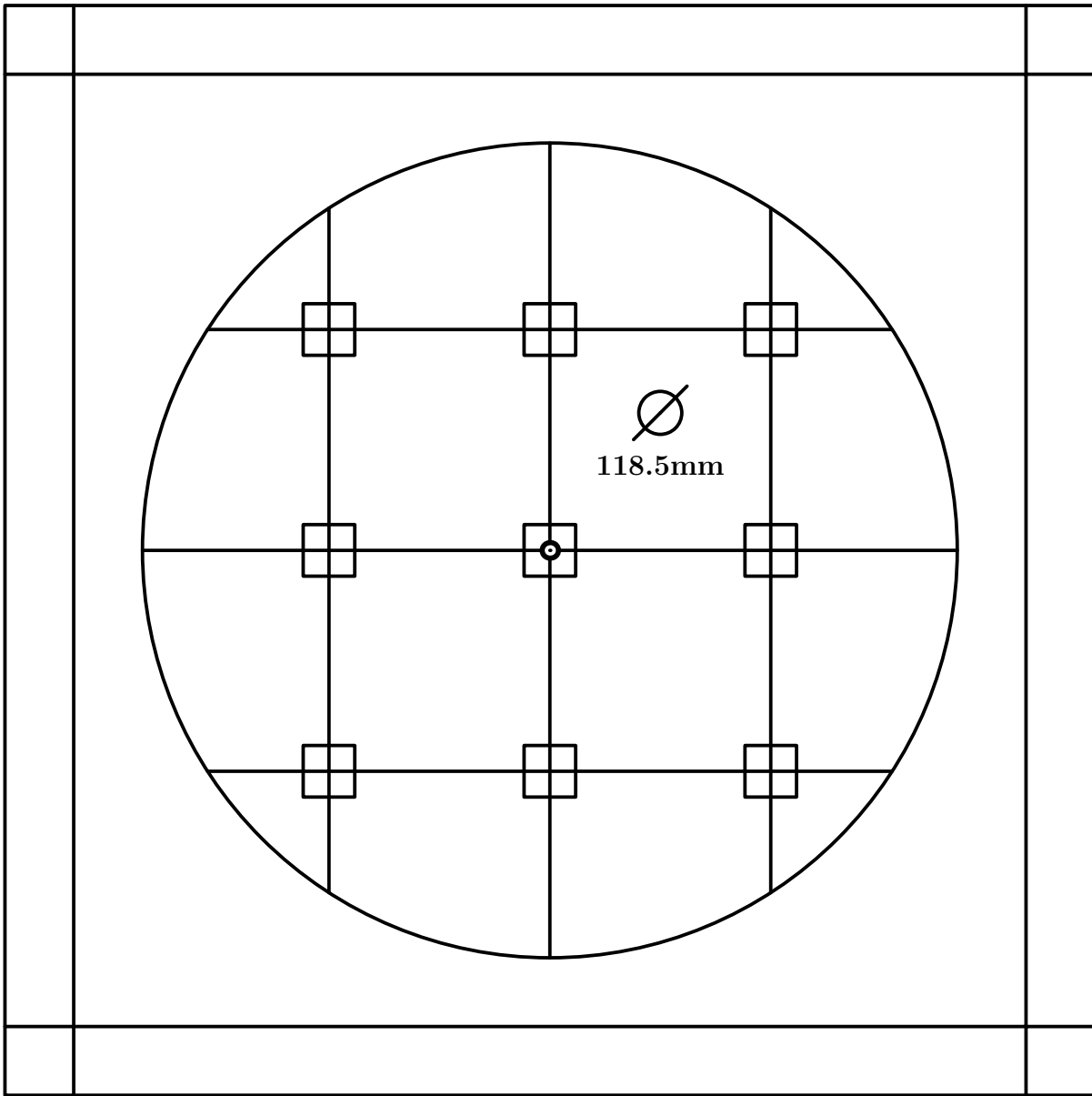

Fig. 75

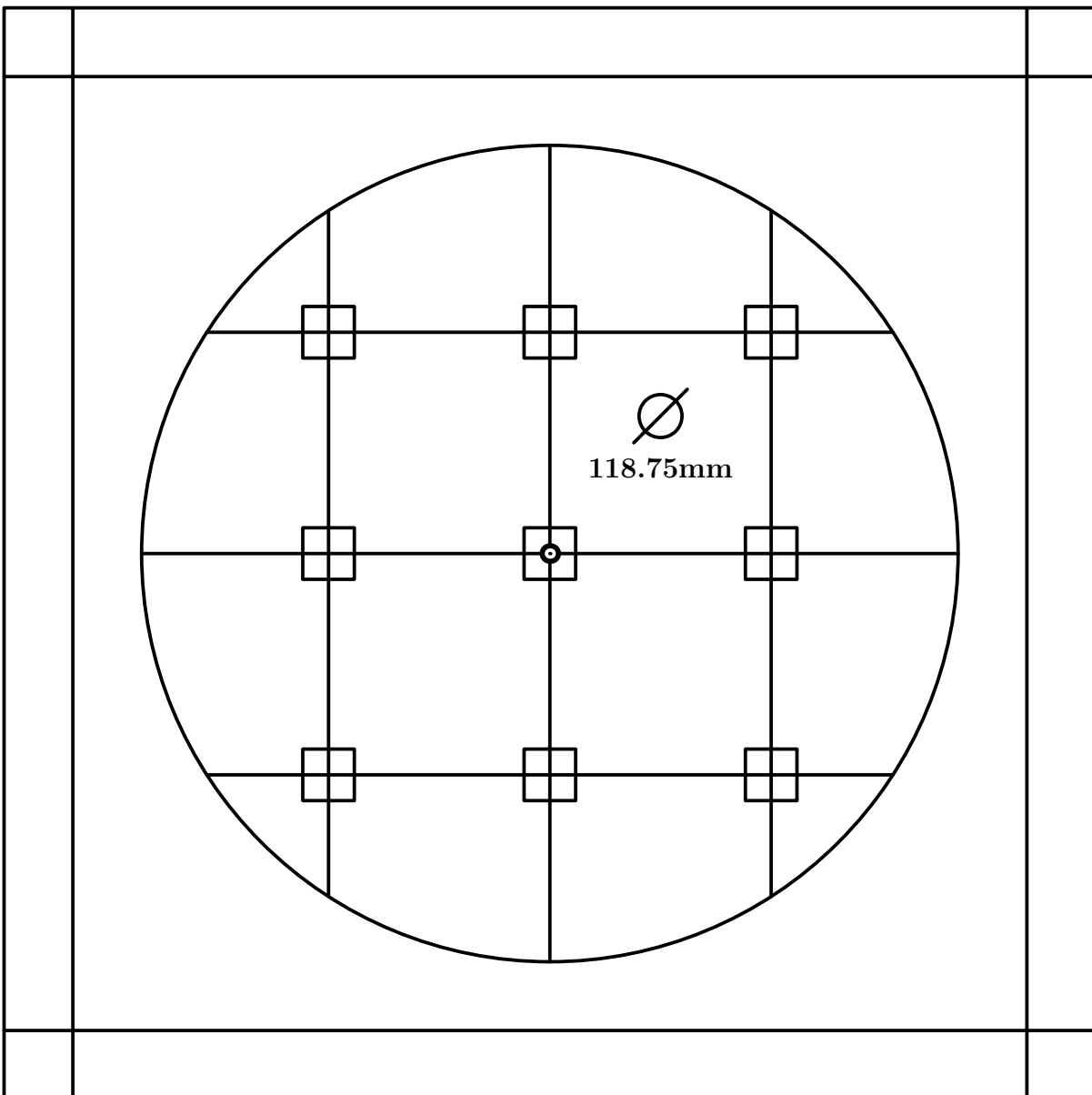

Fig. 76

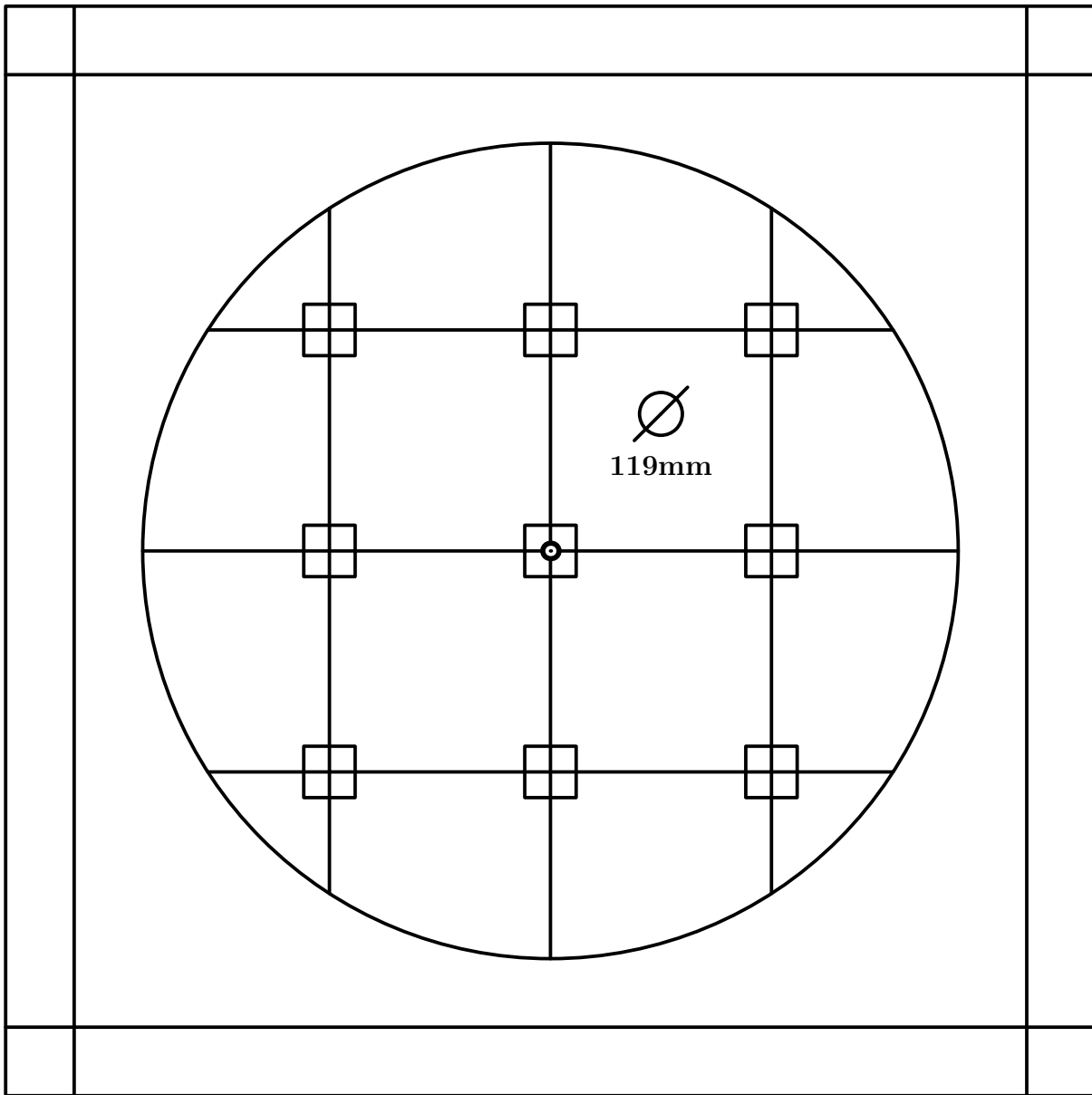

Fig. 77

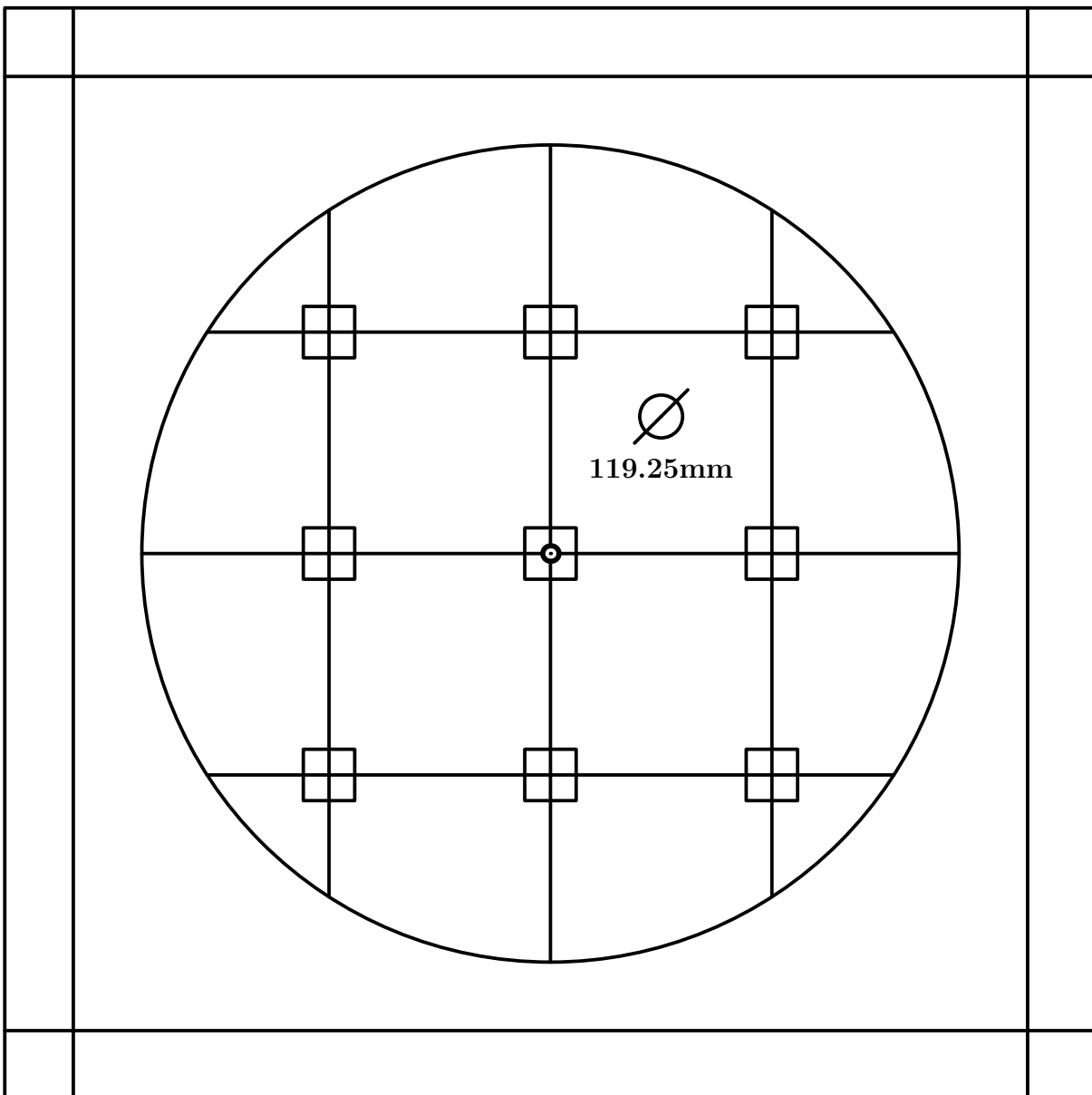

Fig. 78

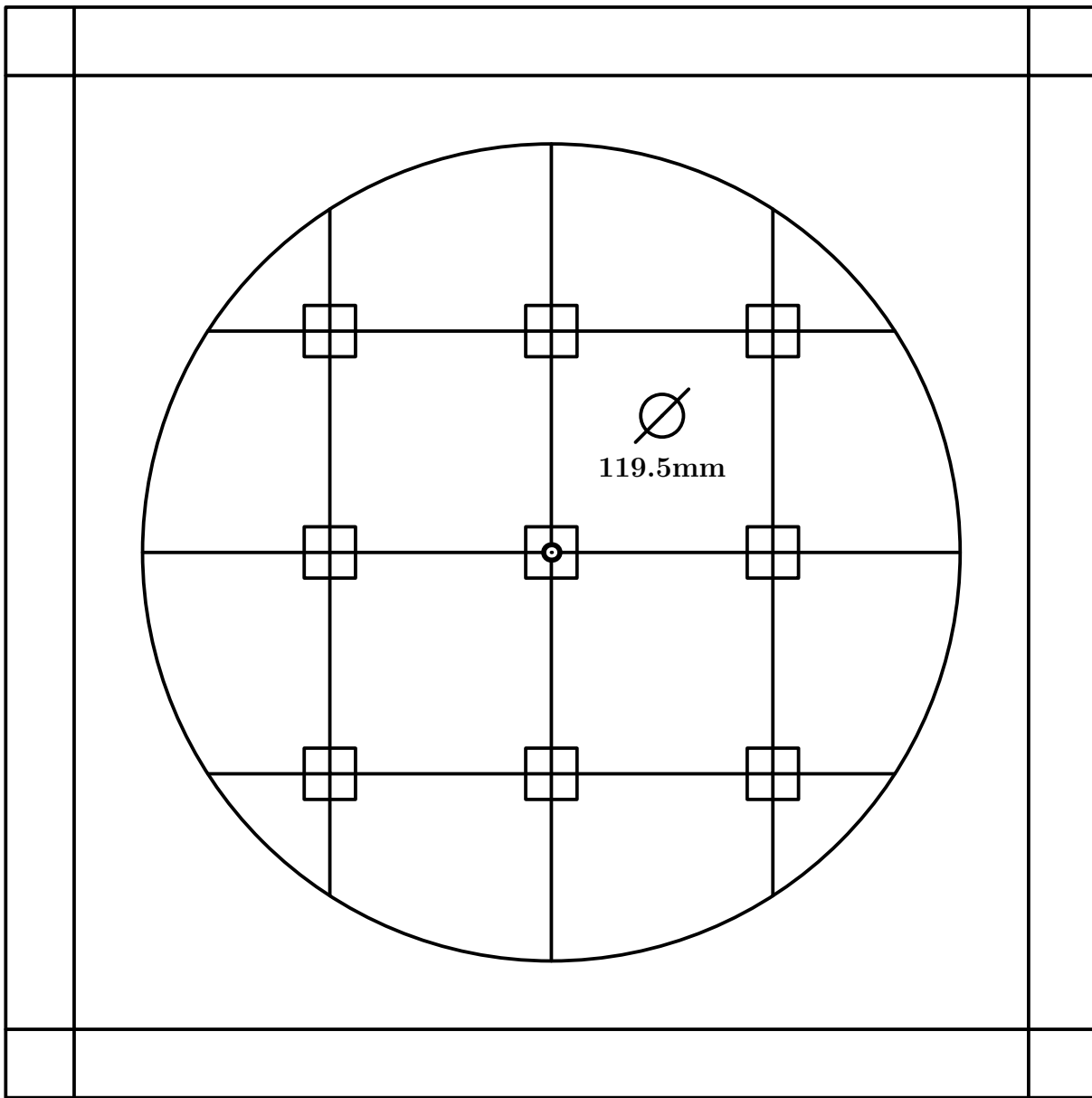

Fig. 79

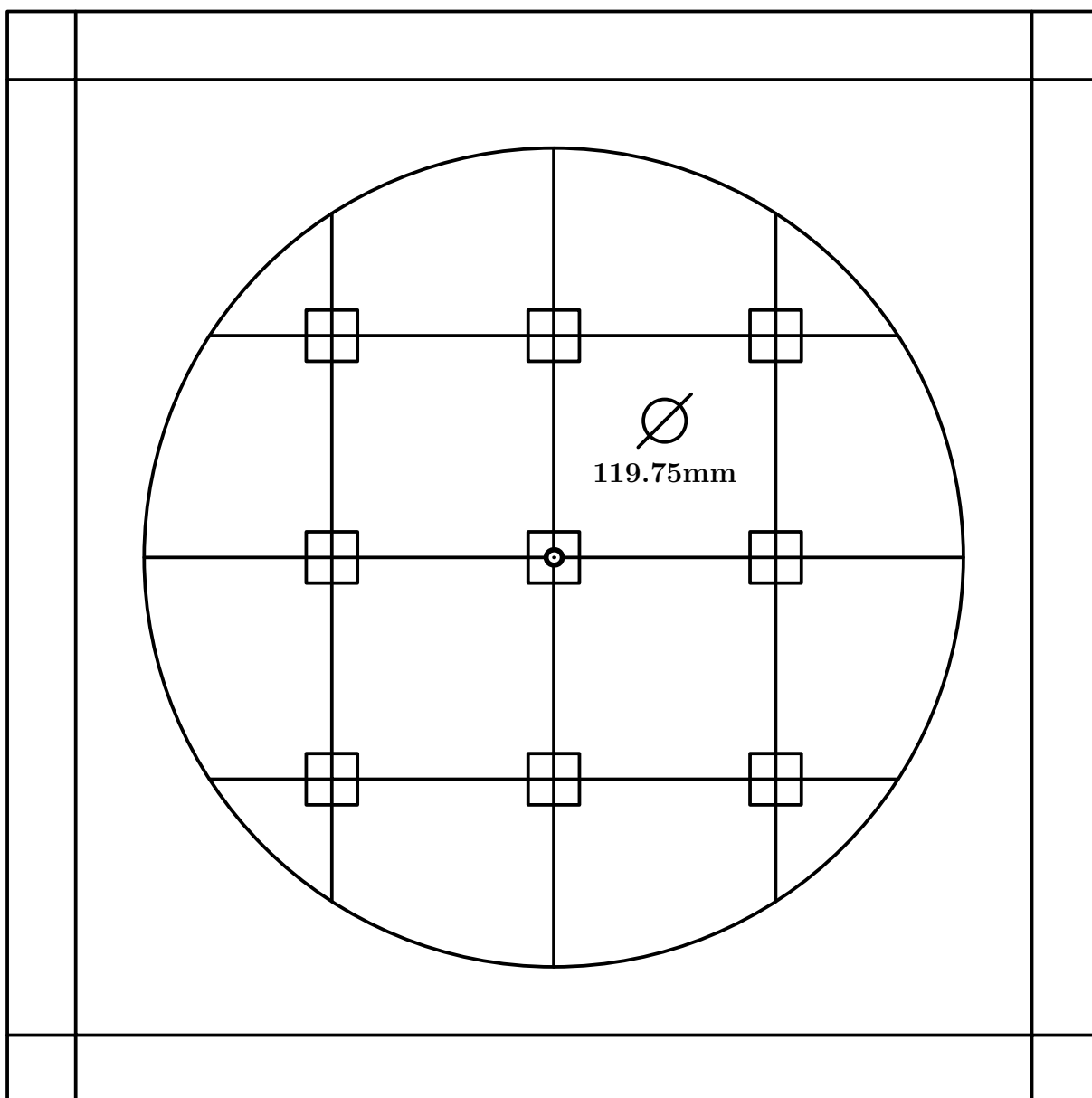

Fig. 80

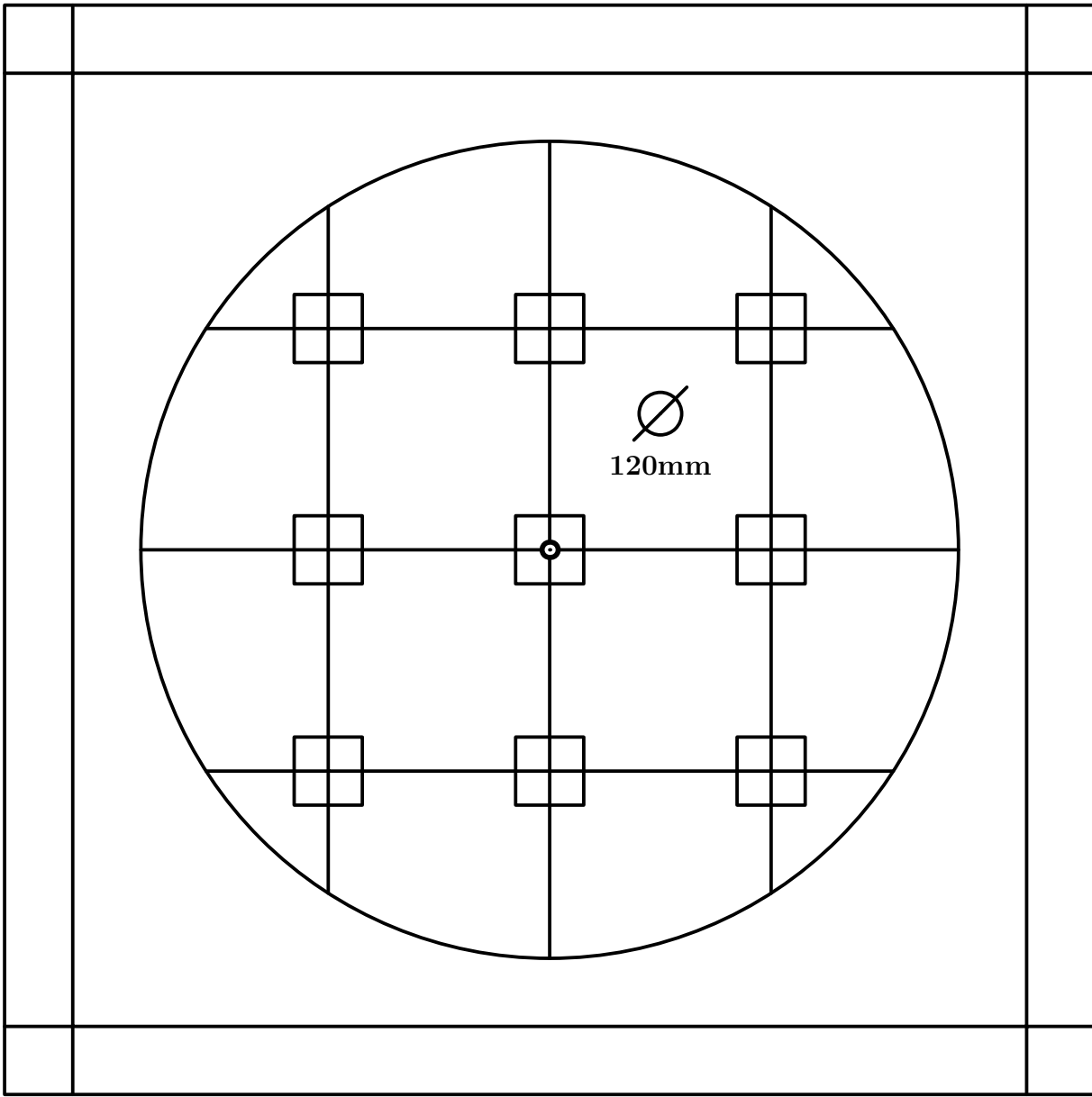

Fig. 81

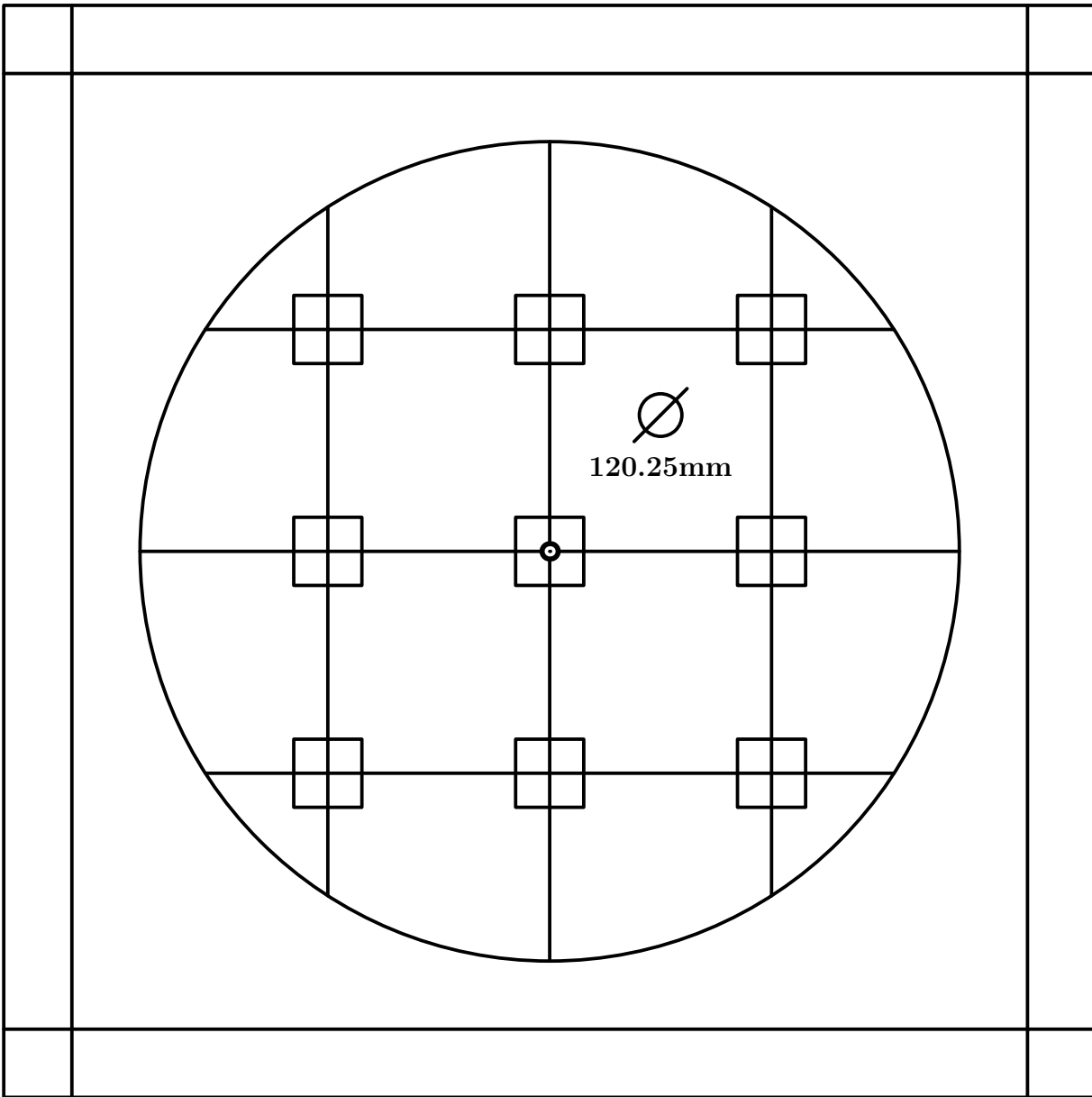

Fig. 82

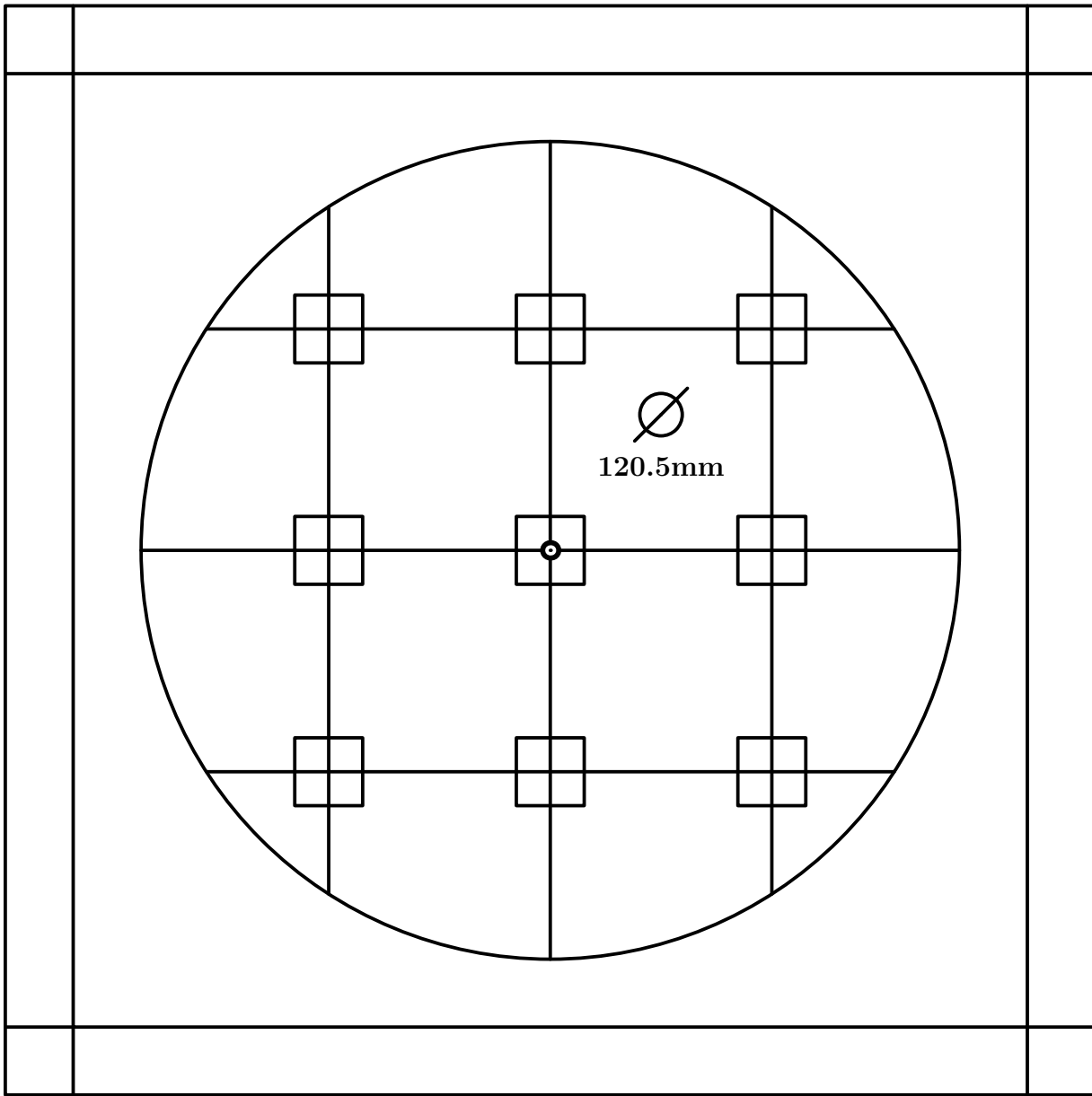

Fig. 83

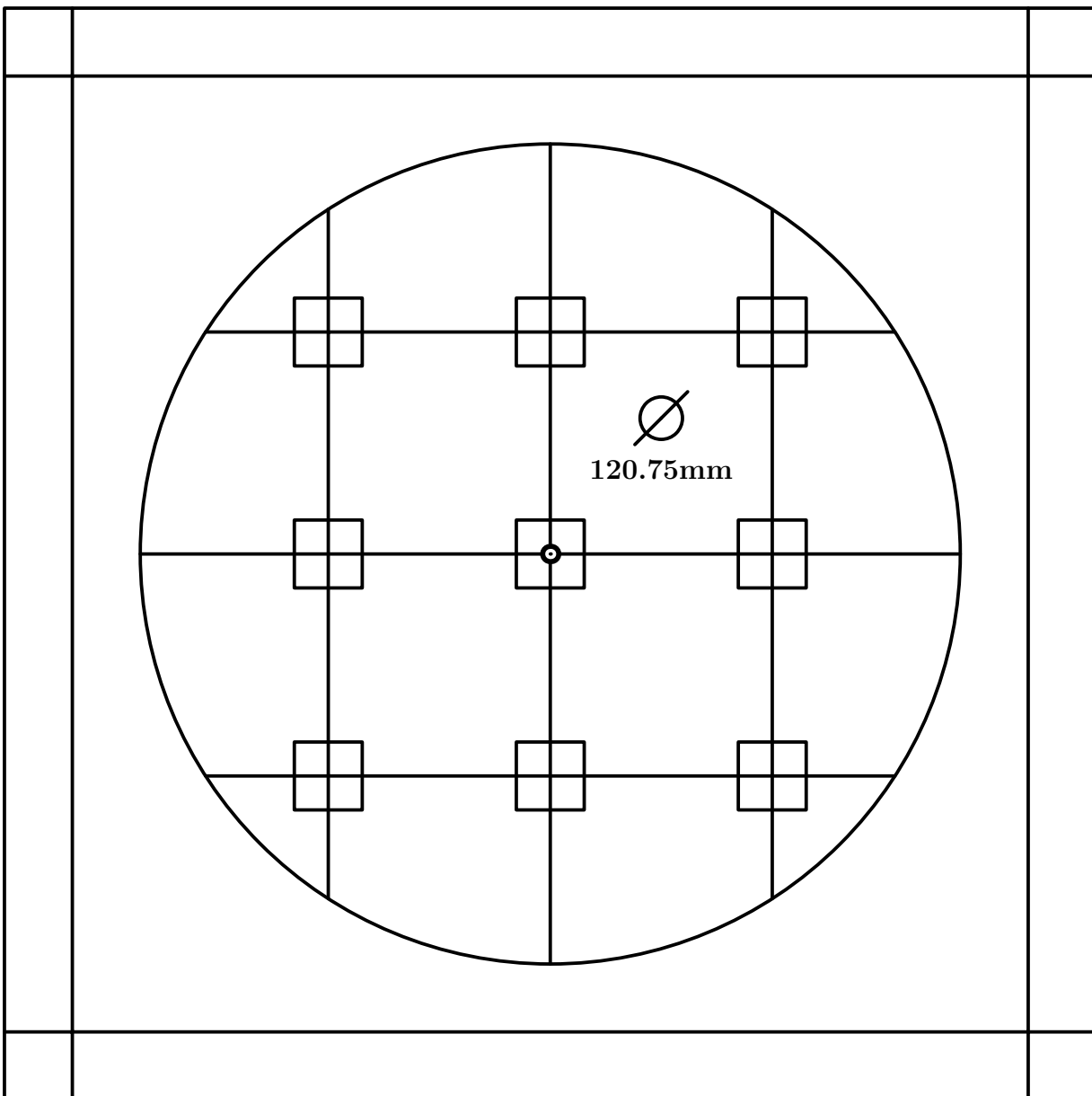

Fig. 84

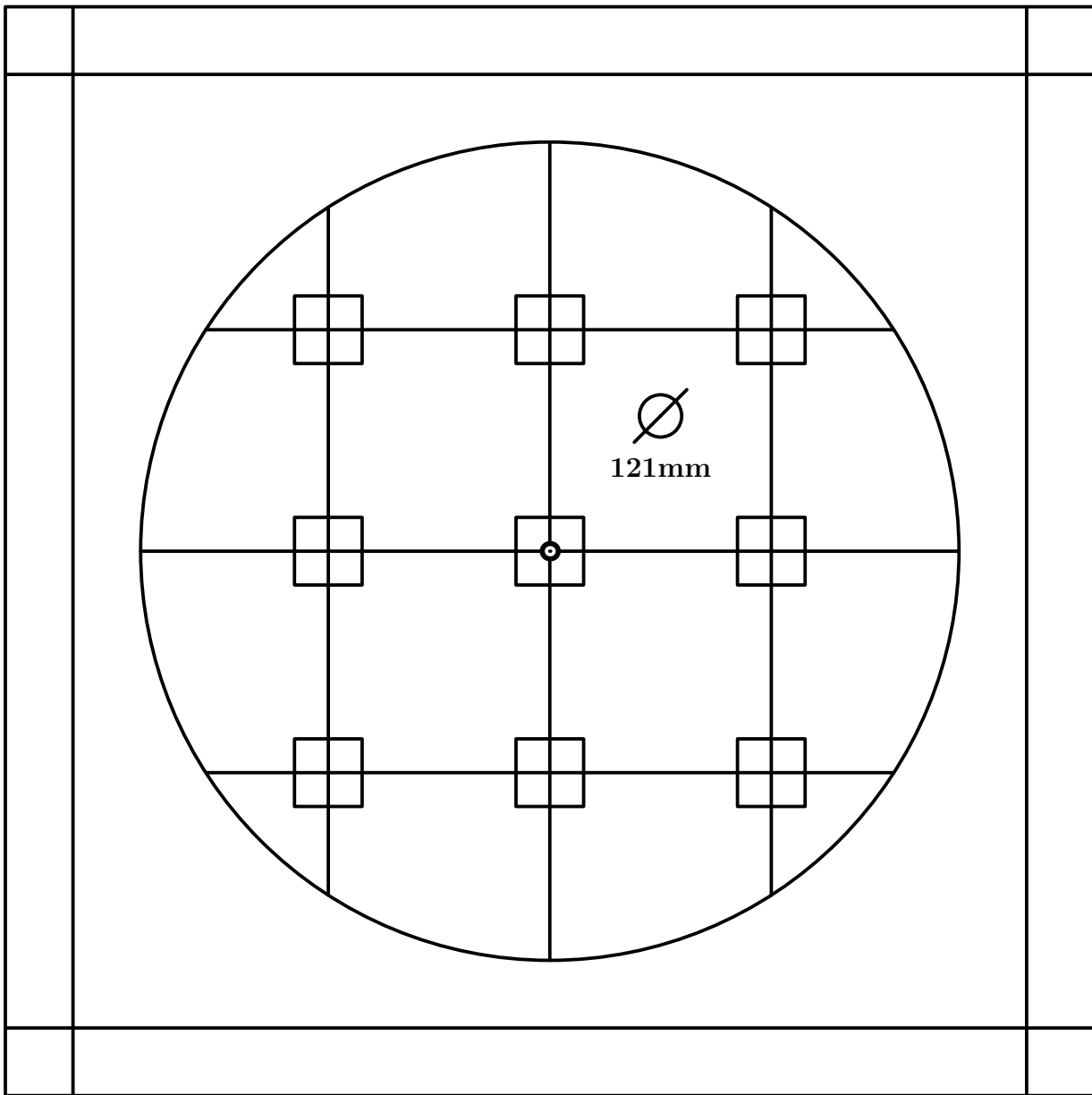

Fig. 85

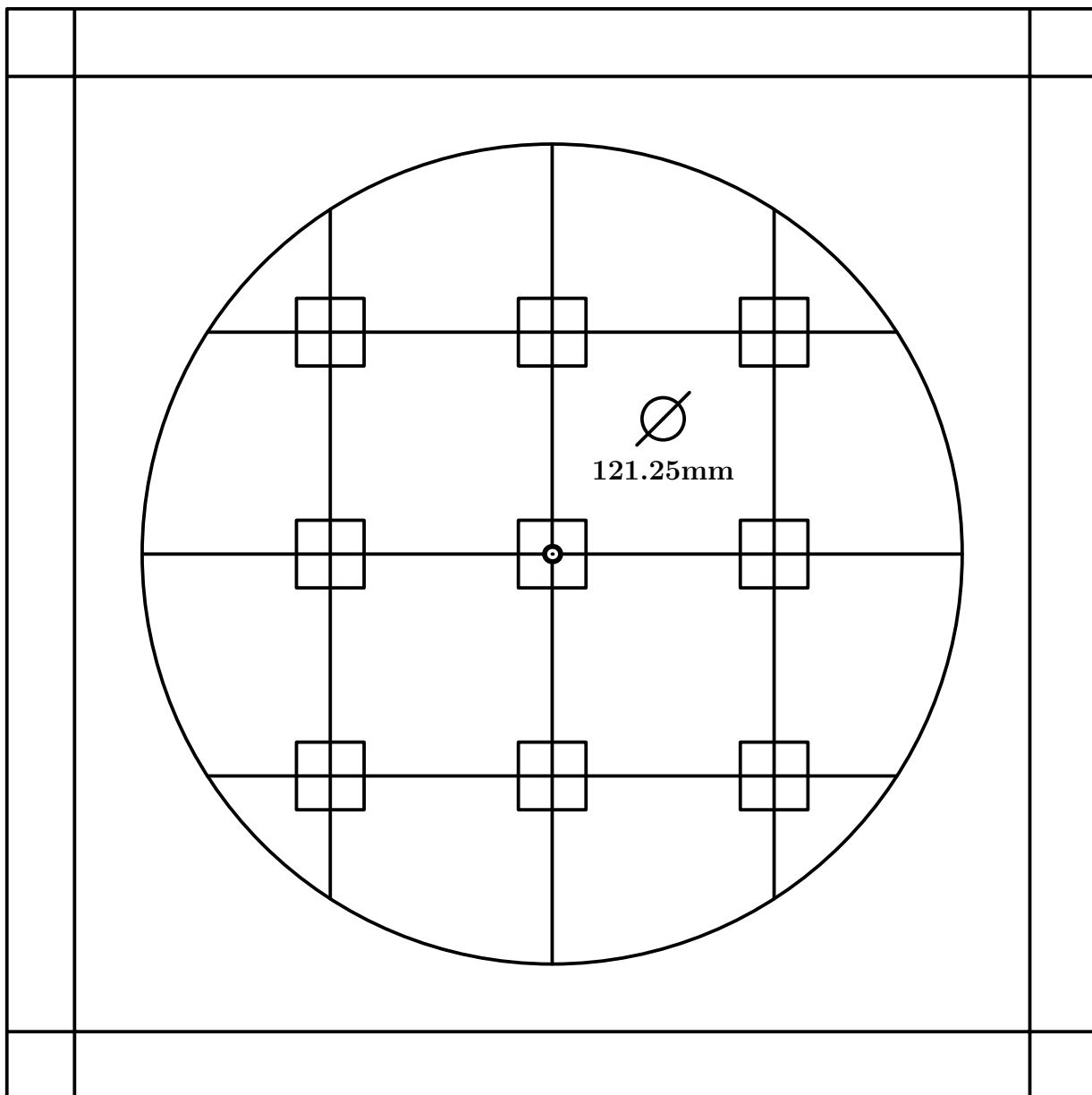

Fig. 86

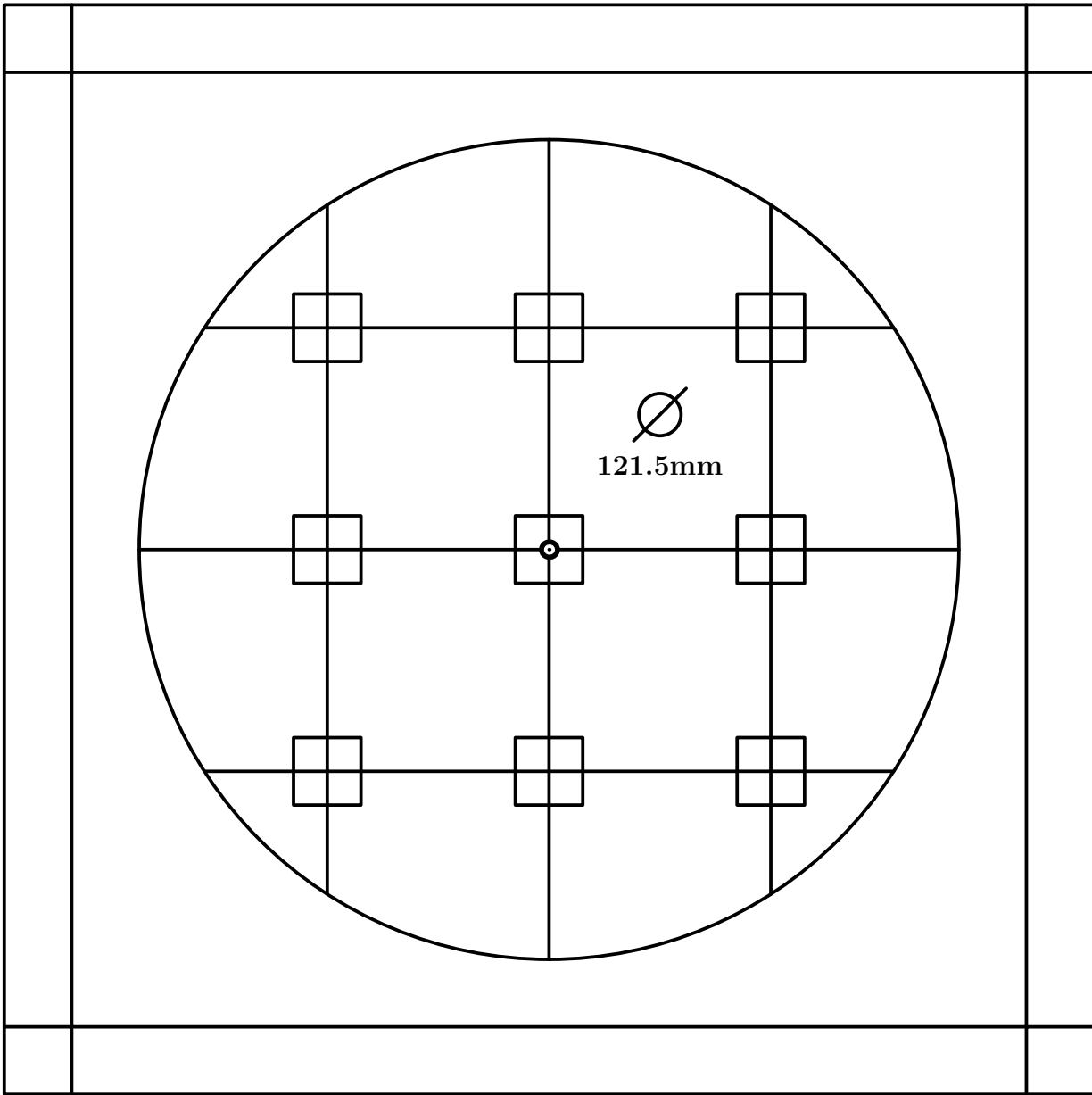

Fig. 87

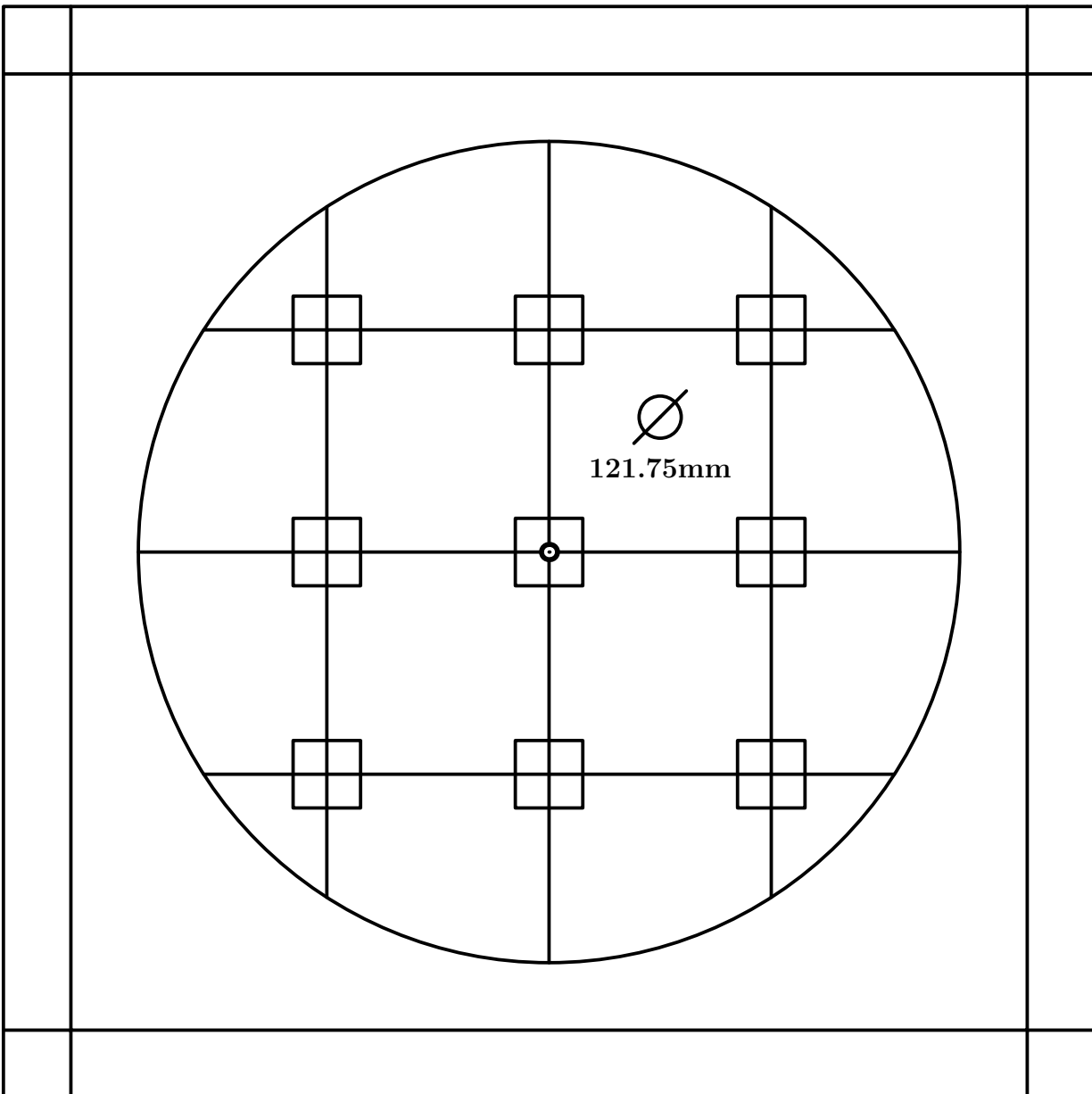

Fig. 88

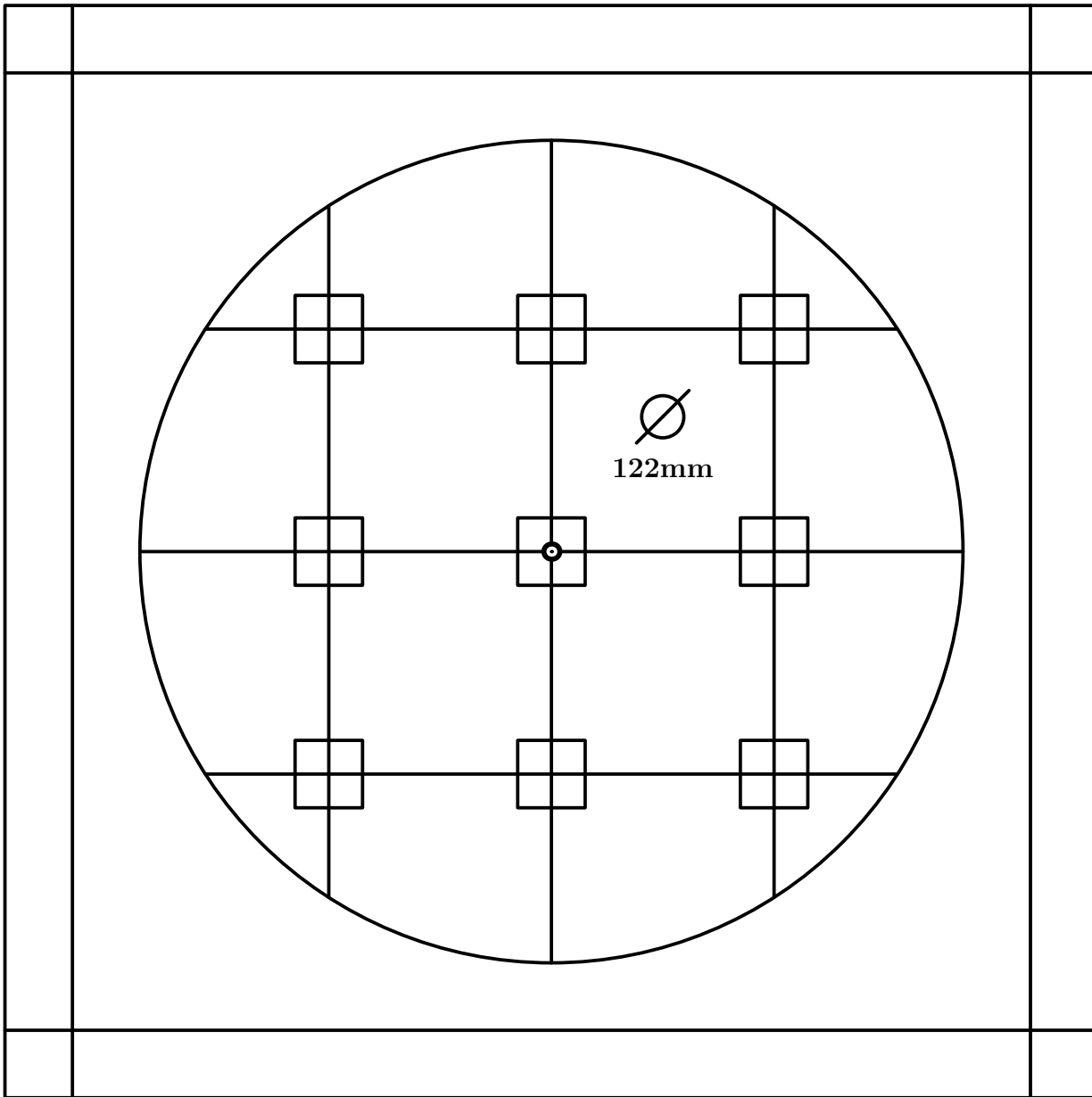

Fig. 89

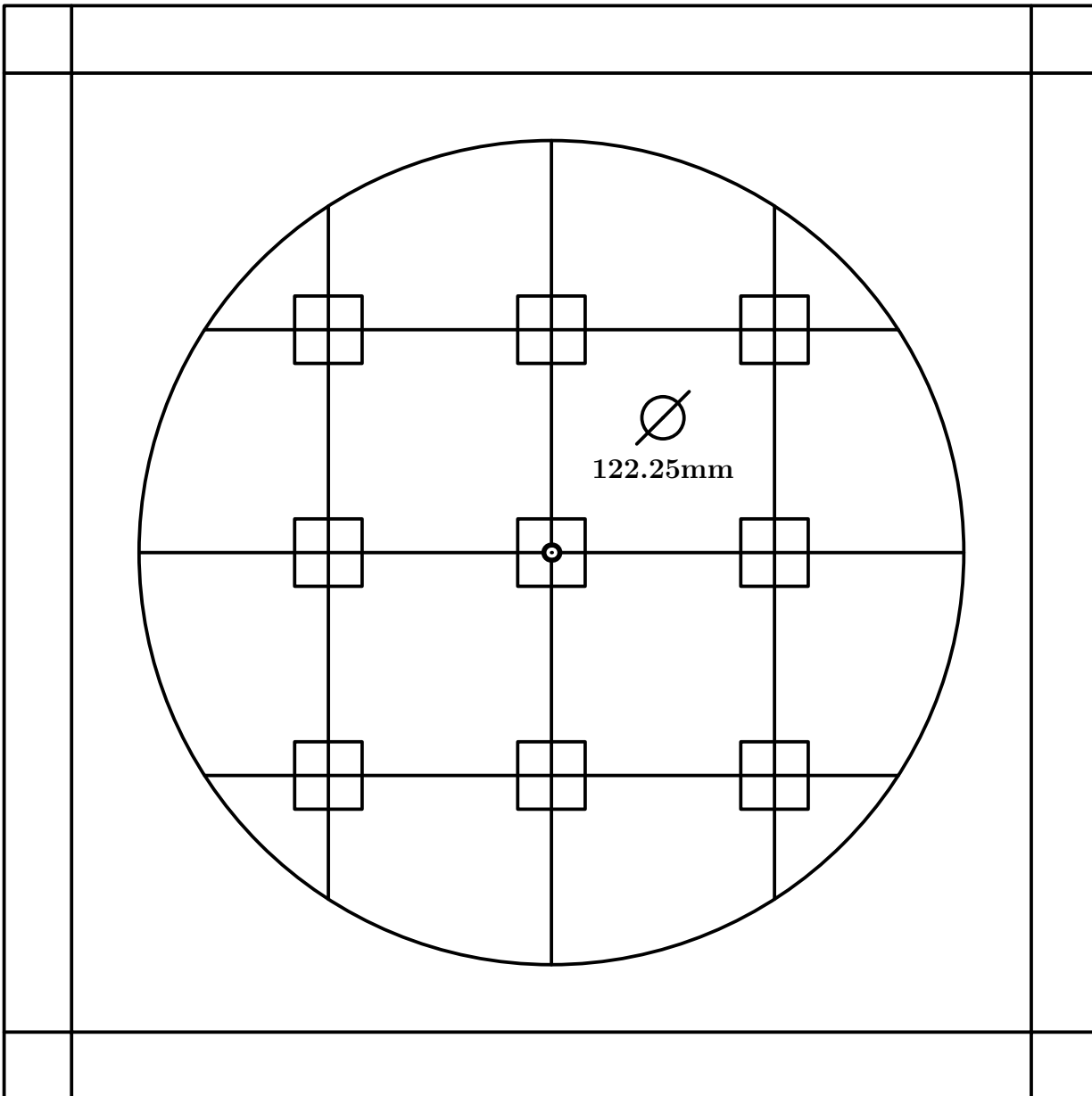

Fig. 90

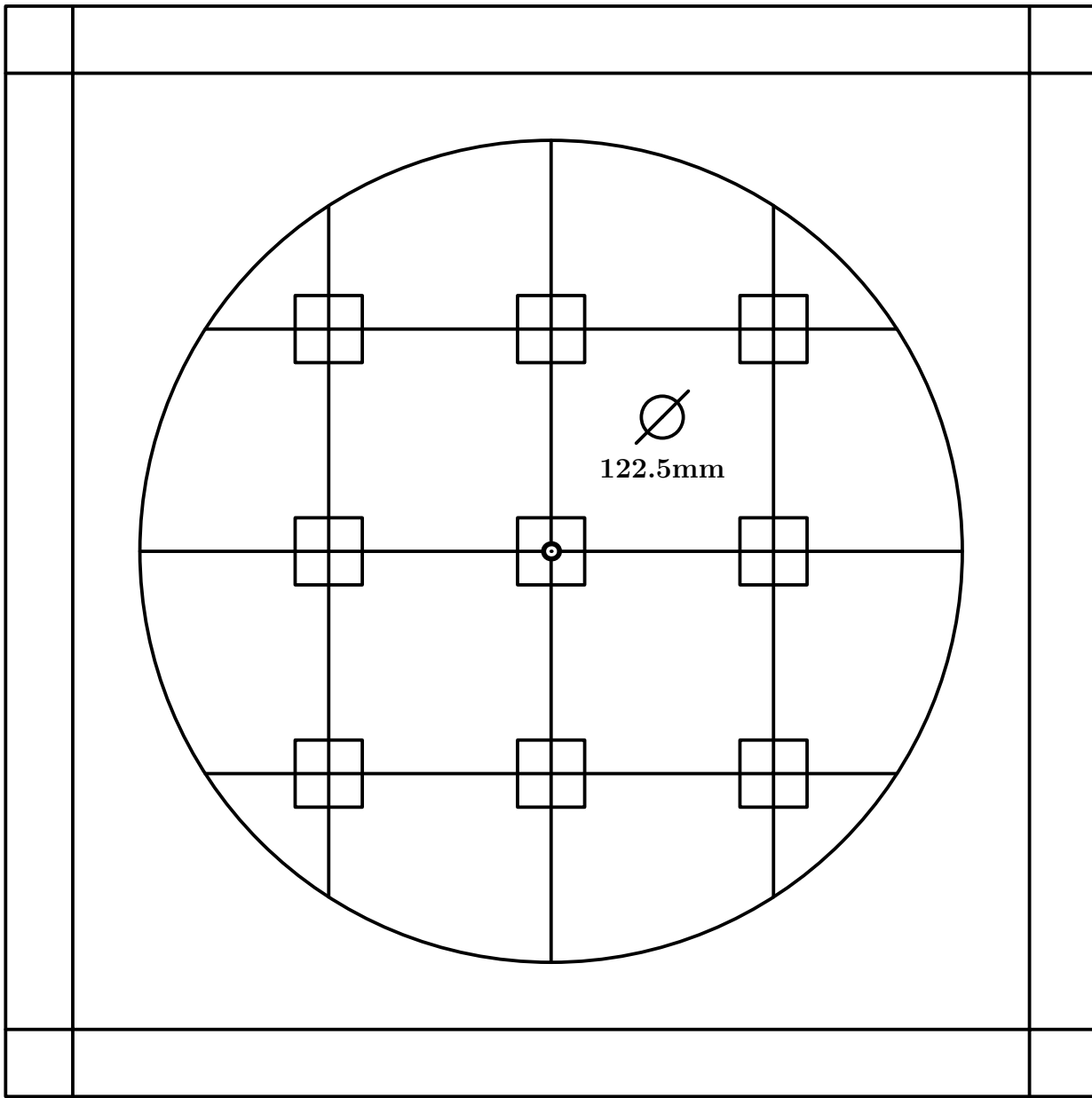

Fig. 91

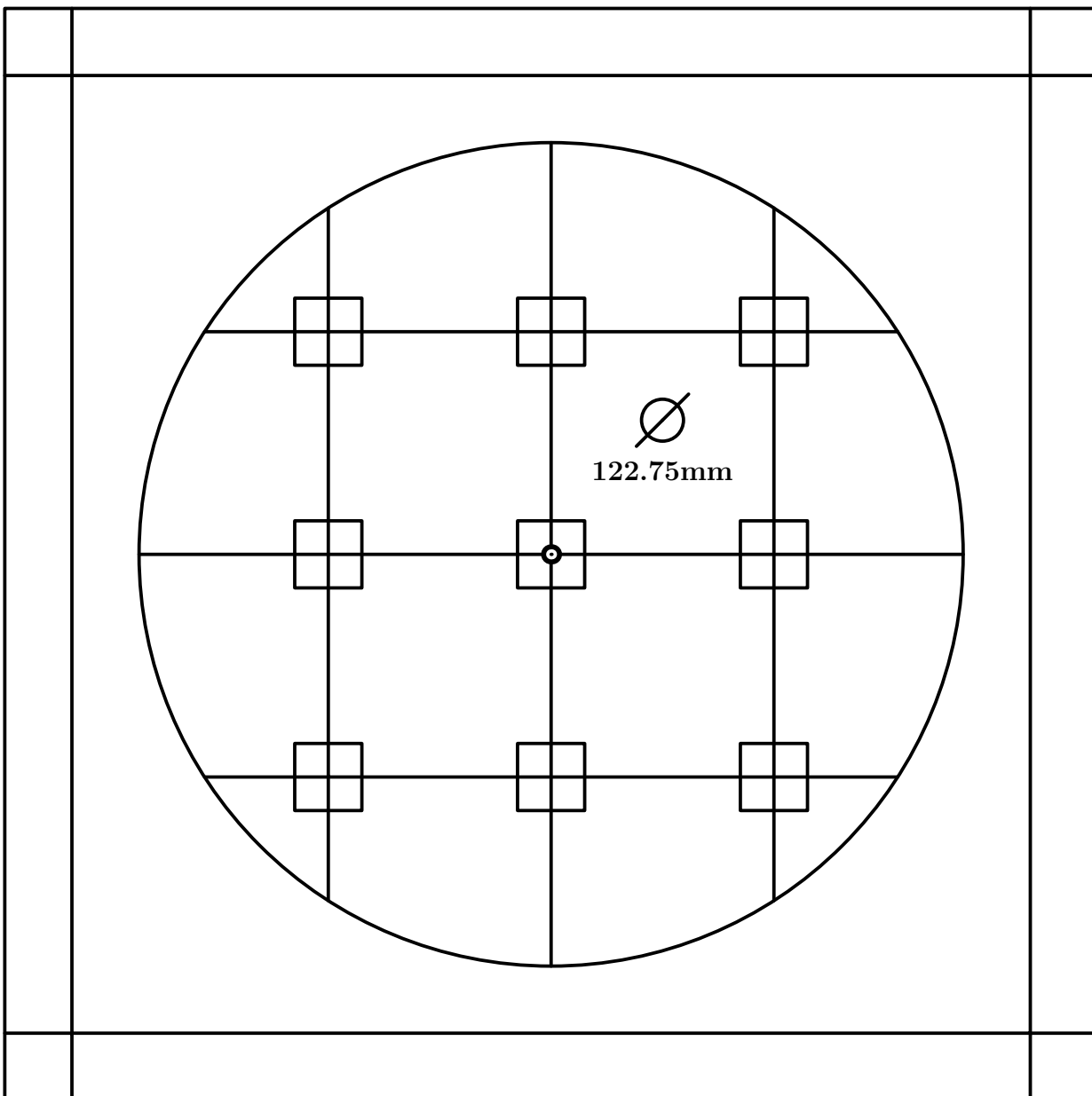

Fig. 92

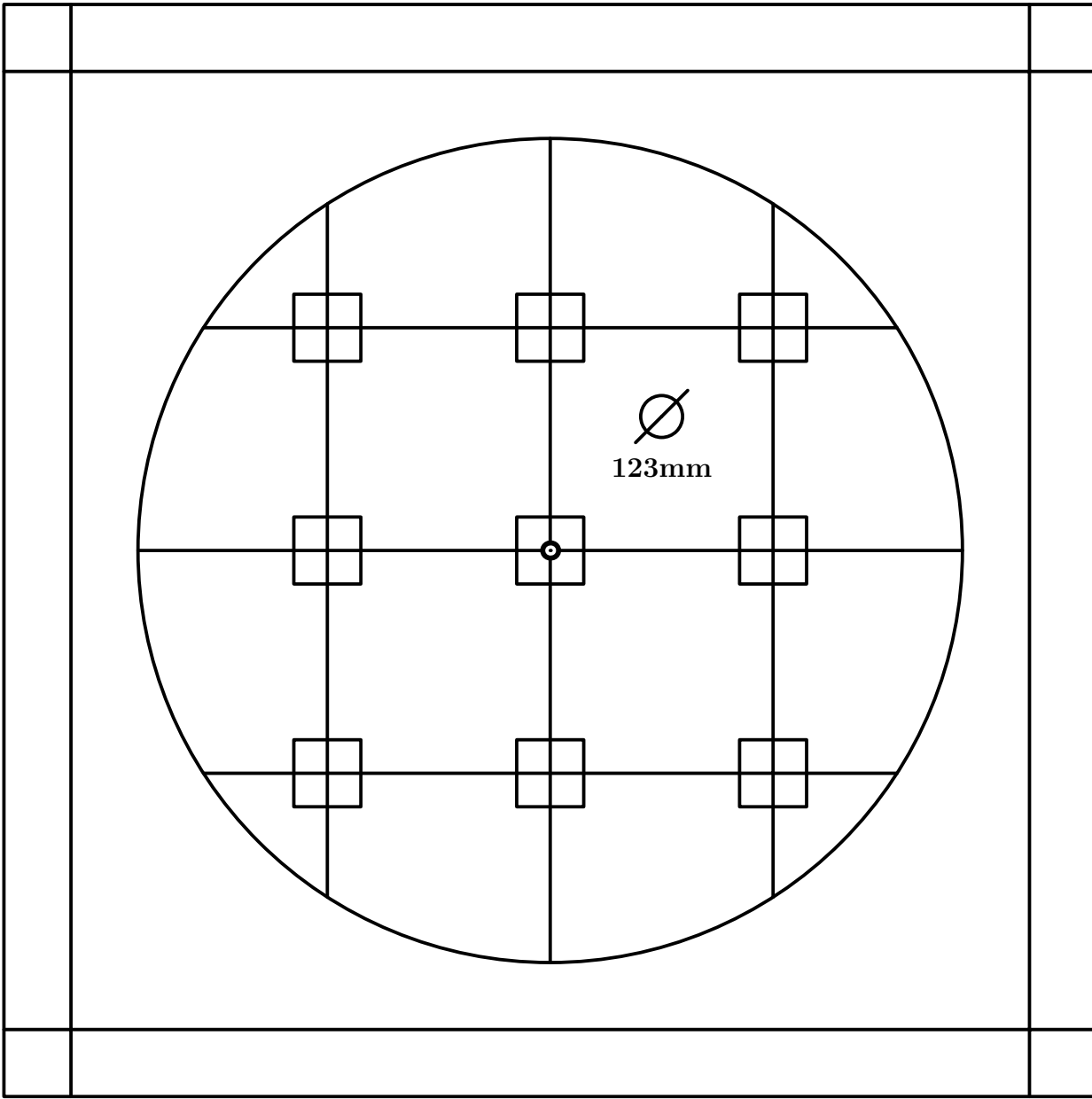

Fig. 93

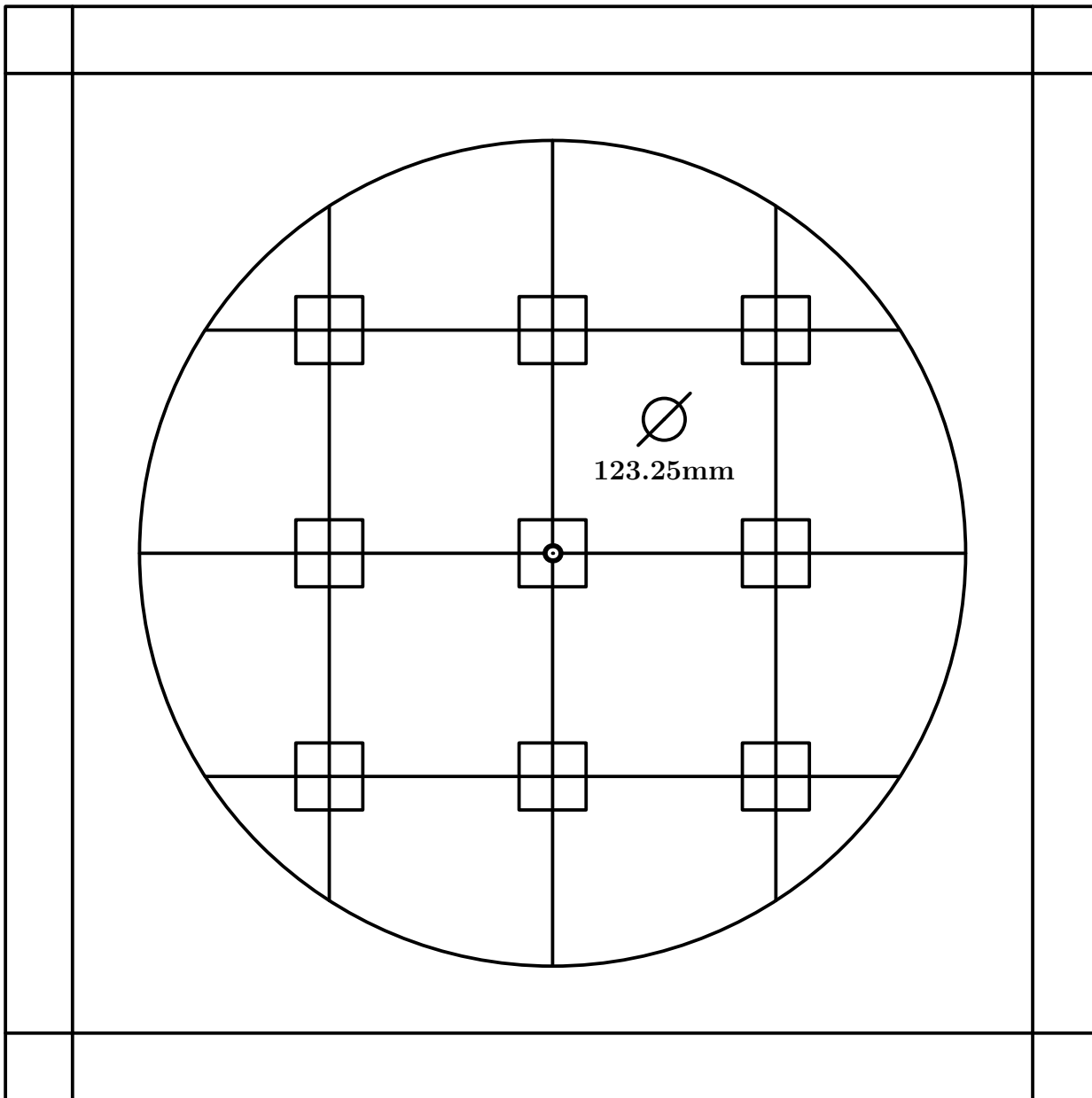

Fig. 94

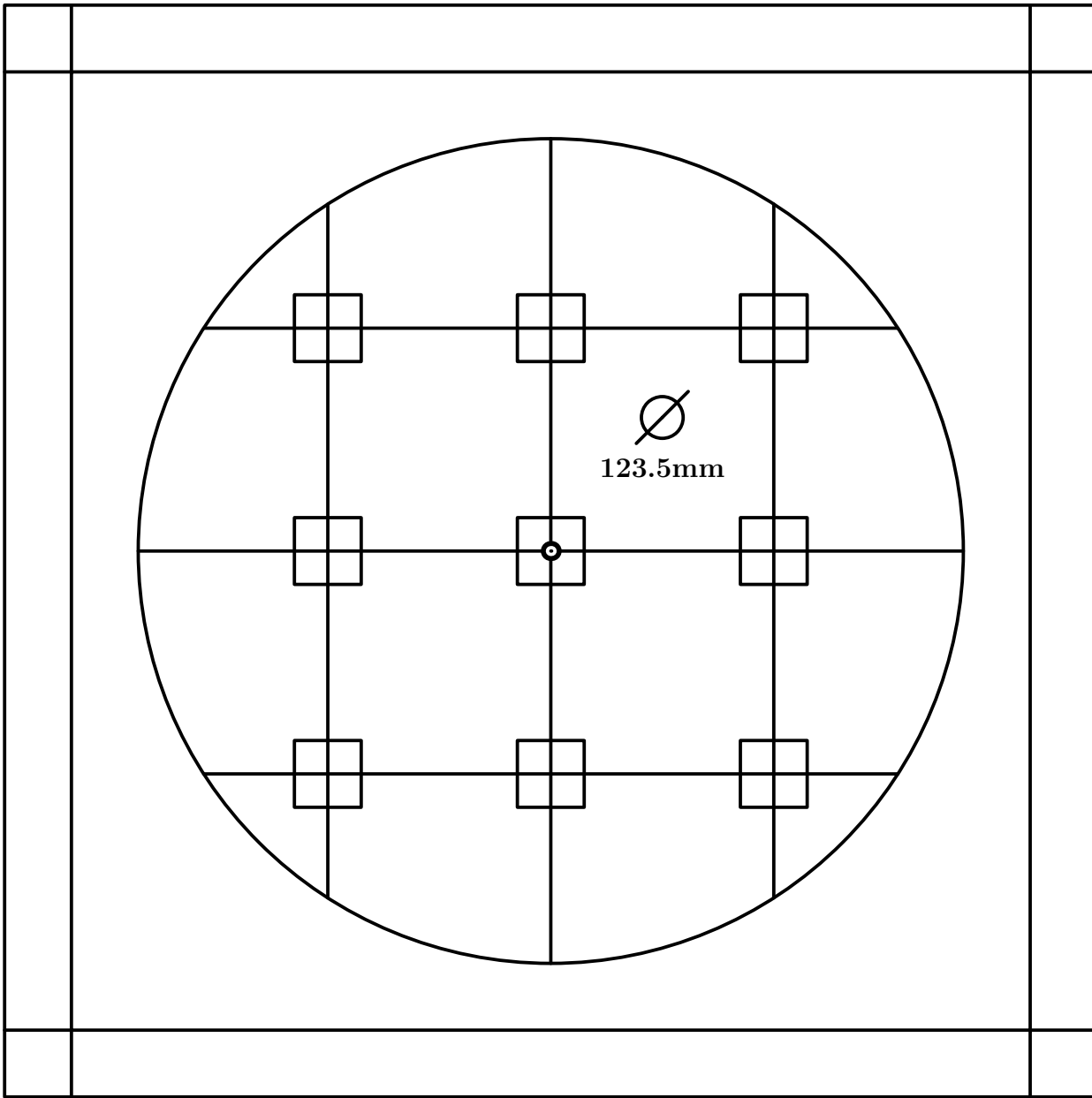

Fig. 95

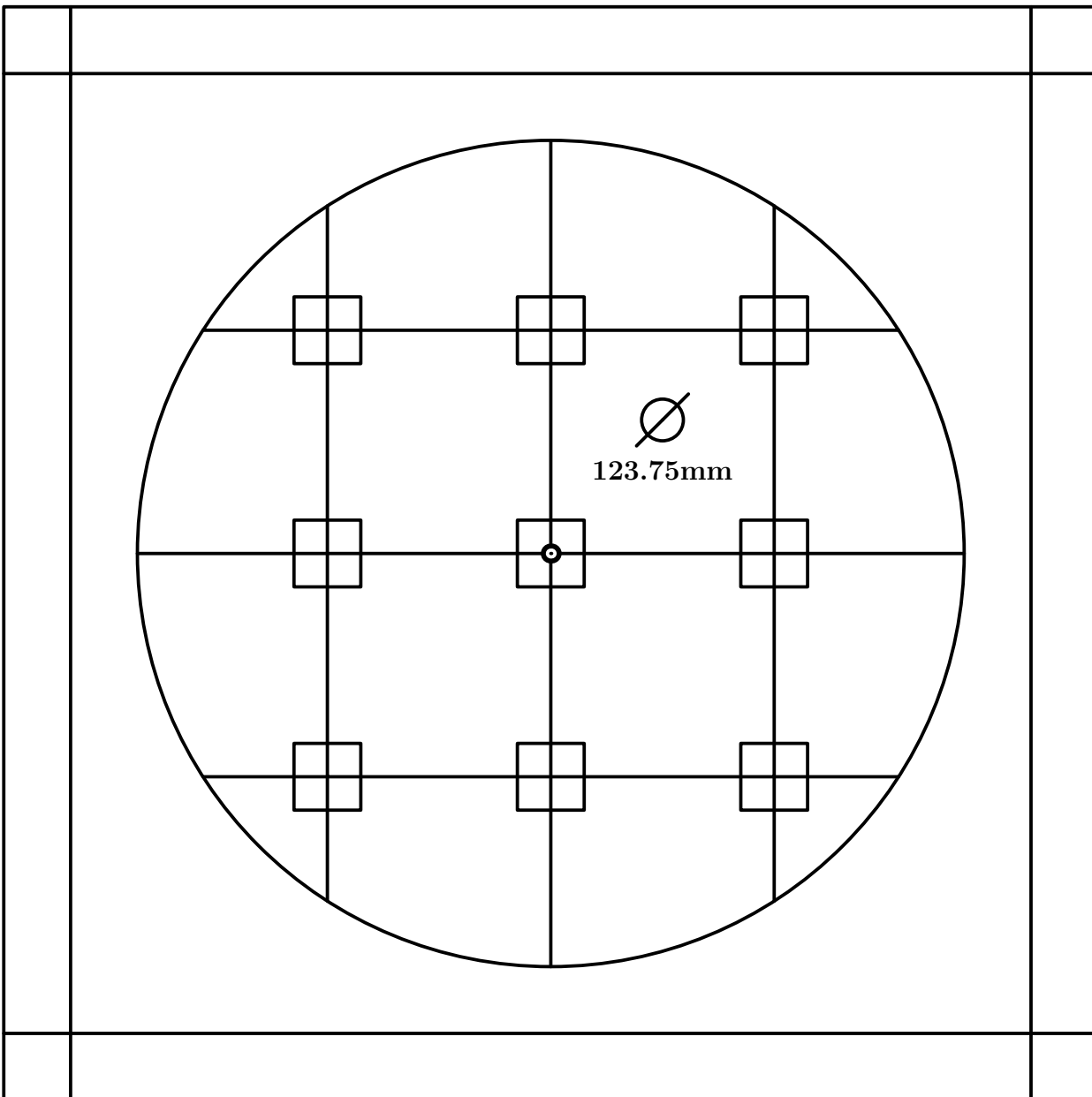

Fig. 96

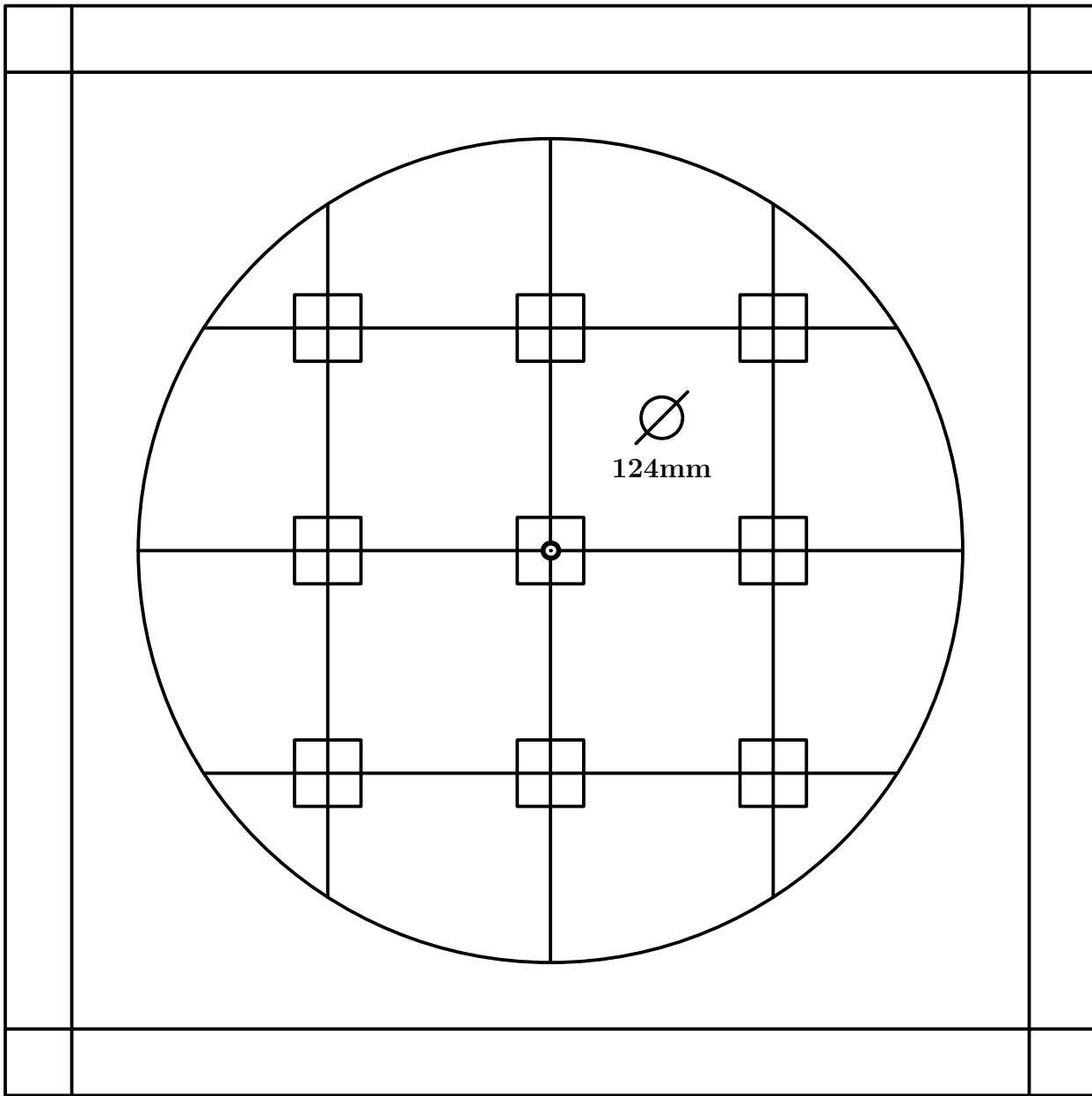

Fig. 97

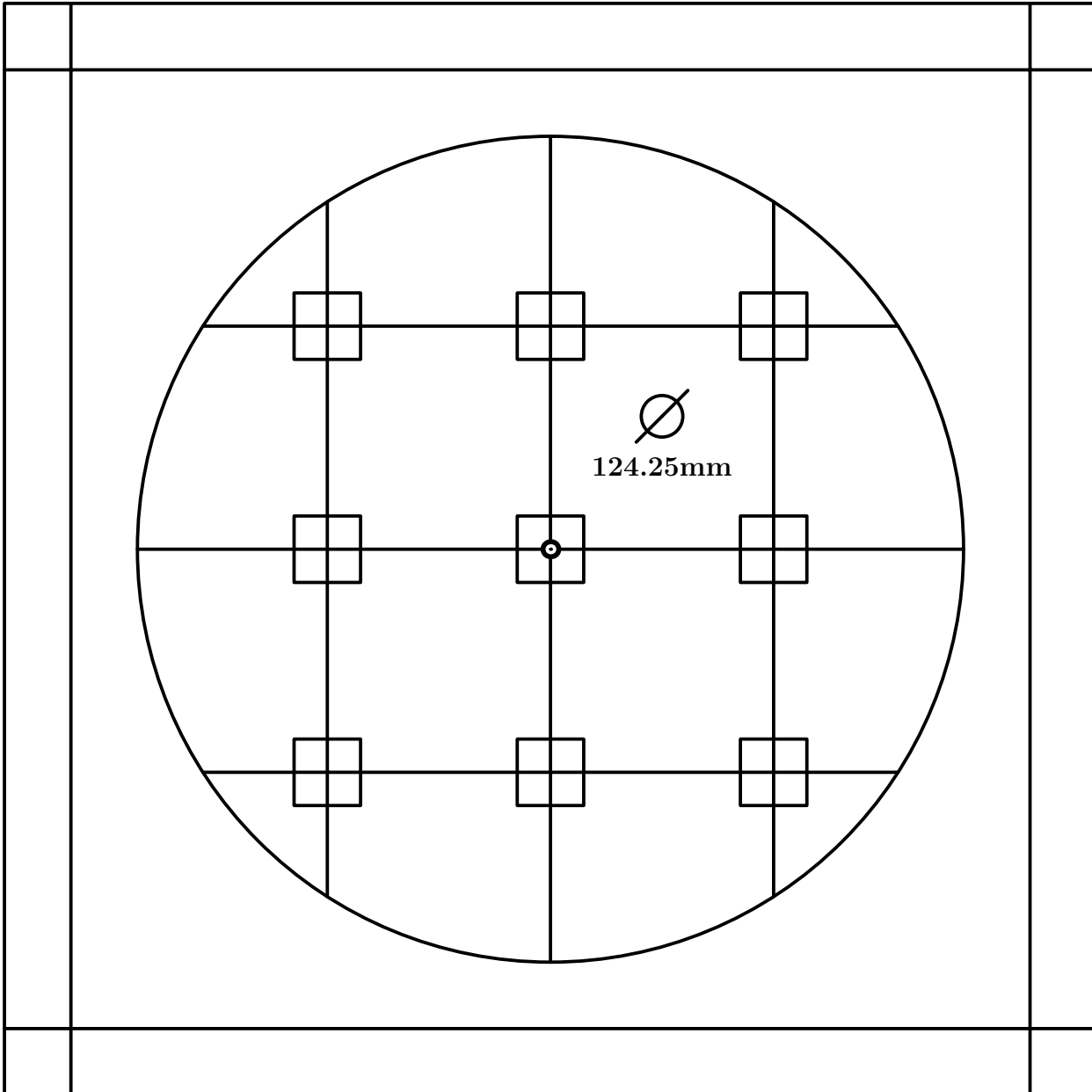

Fig. 98

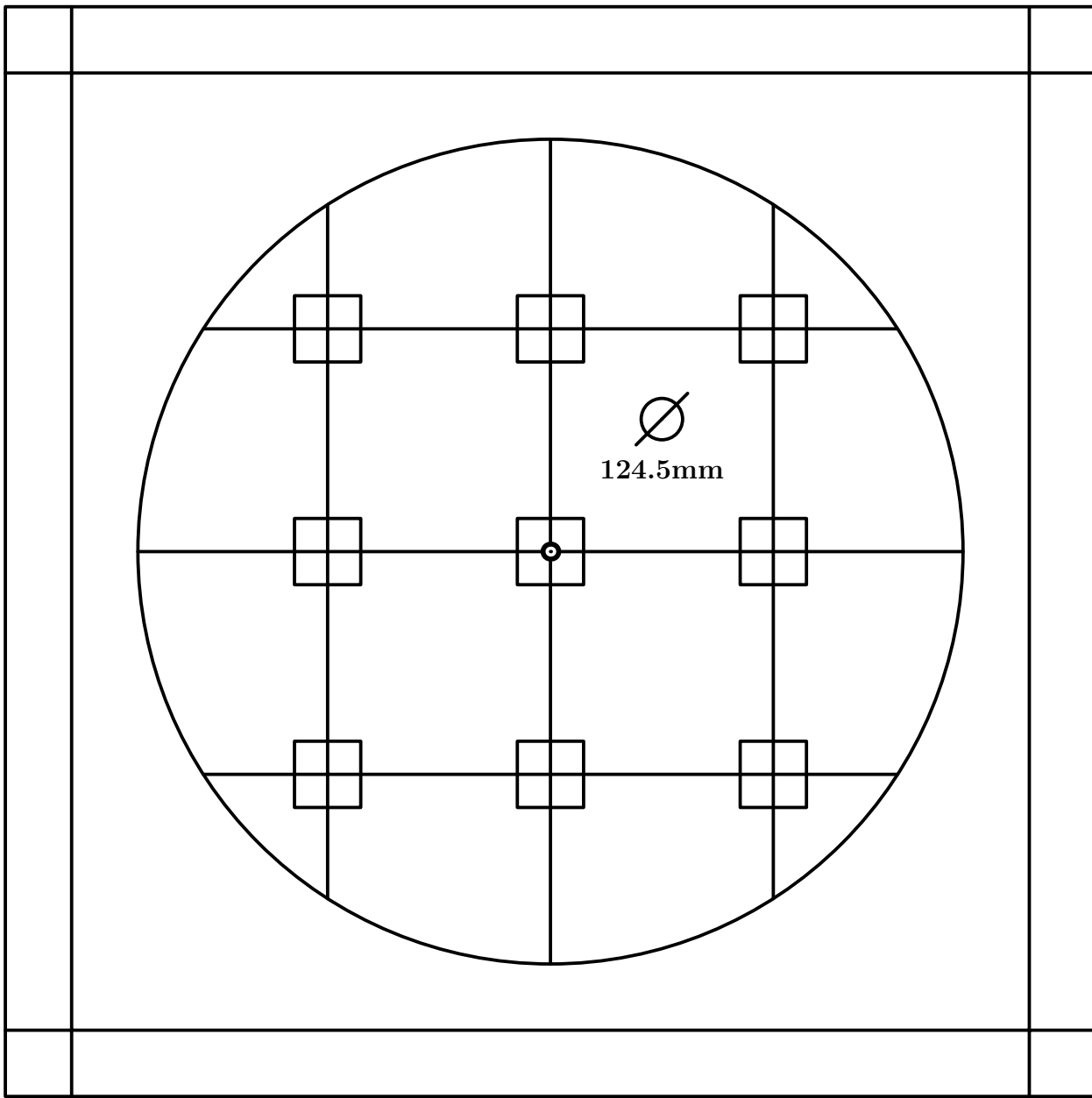

Fig. 99

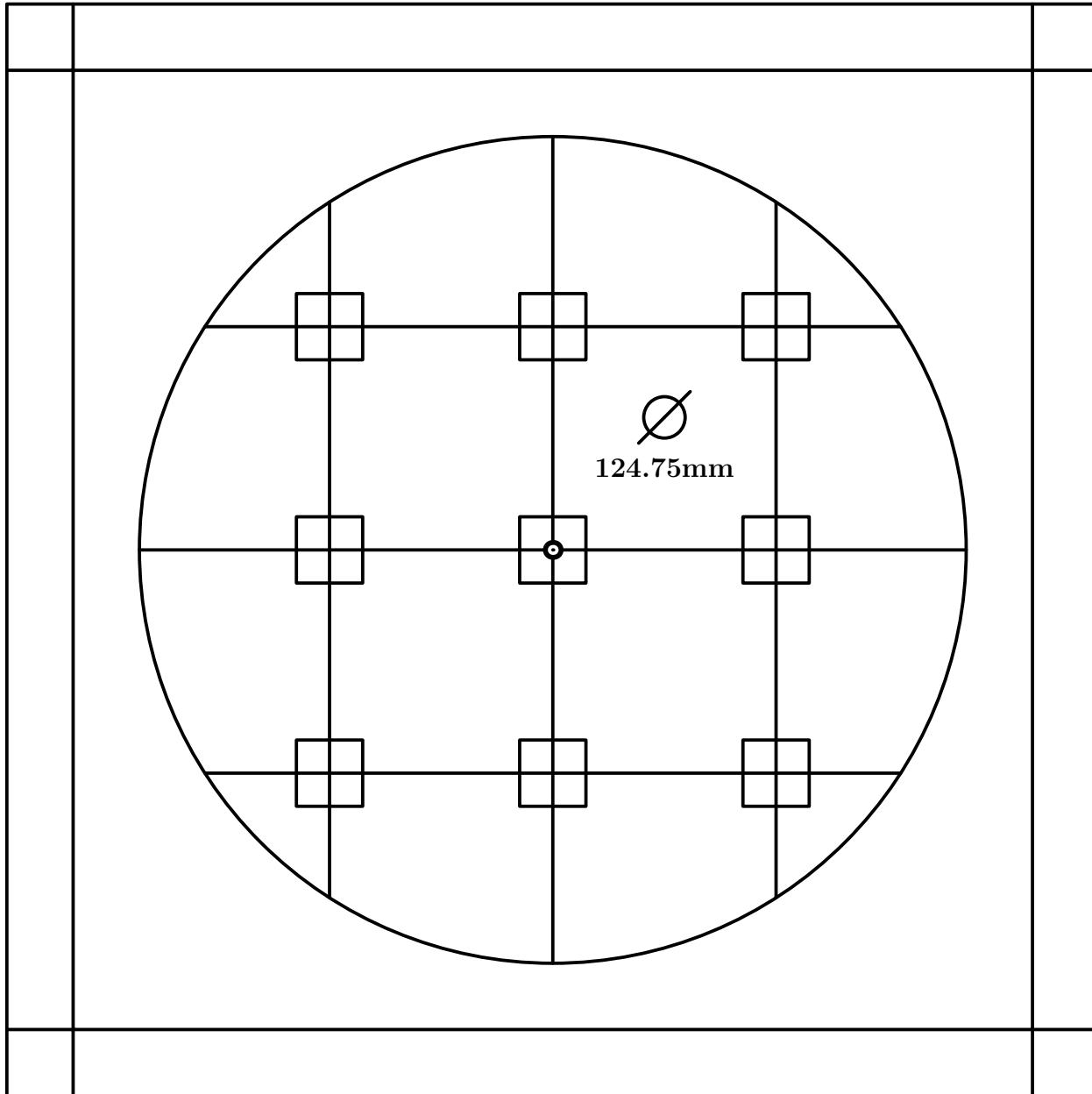

Fig. 100

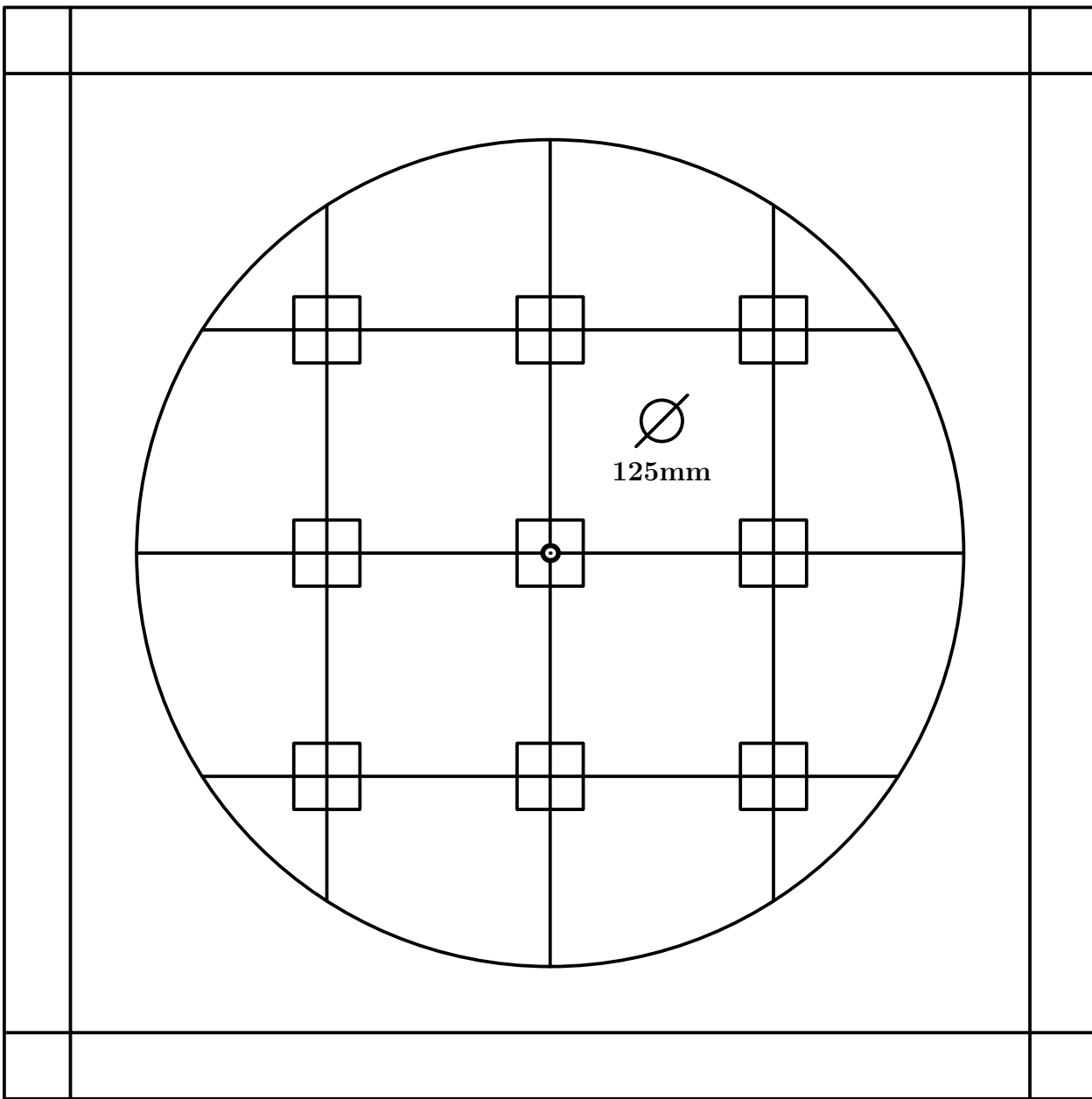

Fig. 101

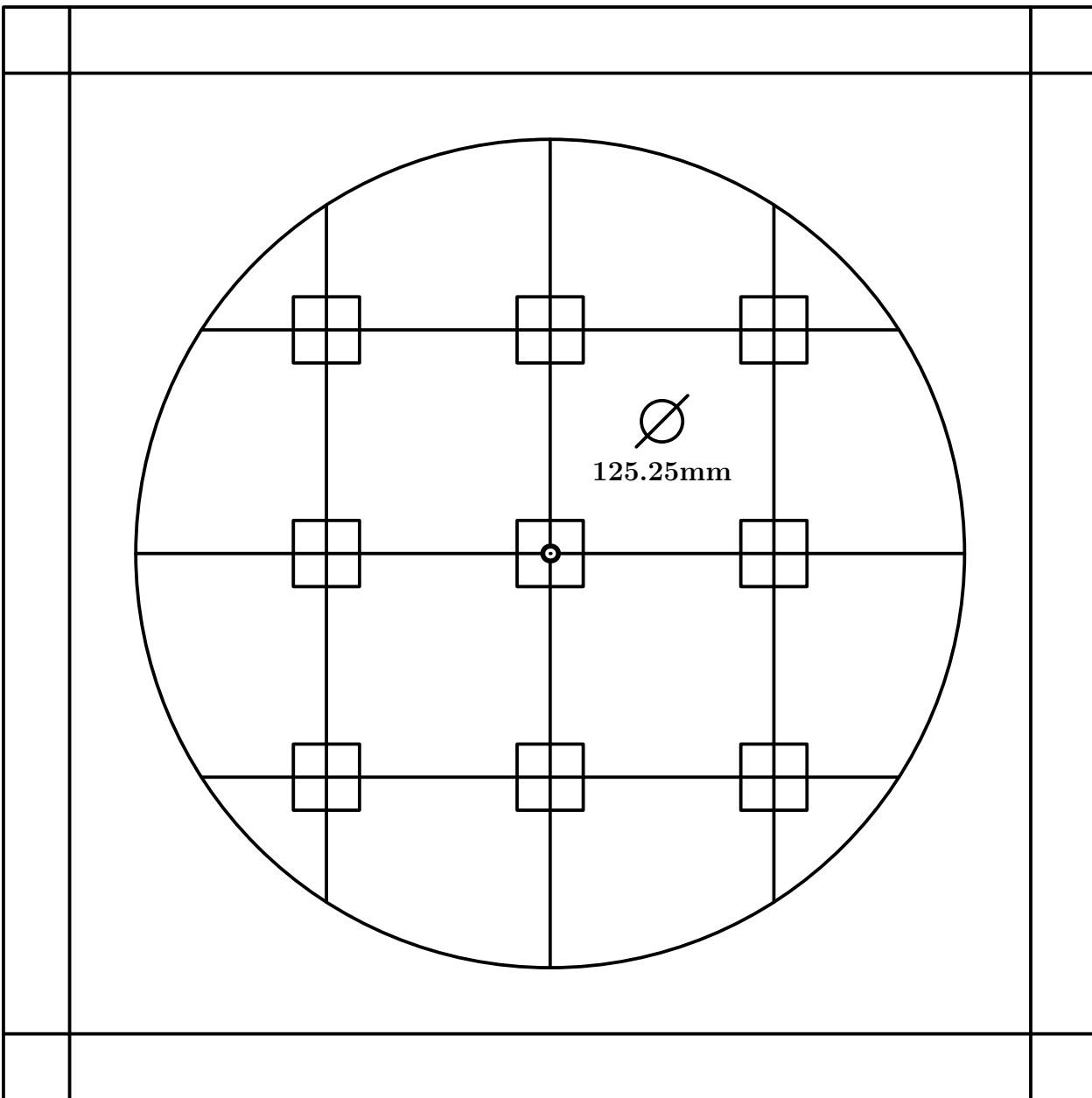

Fig. 102

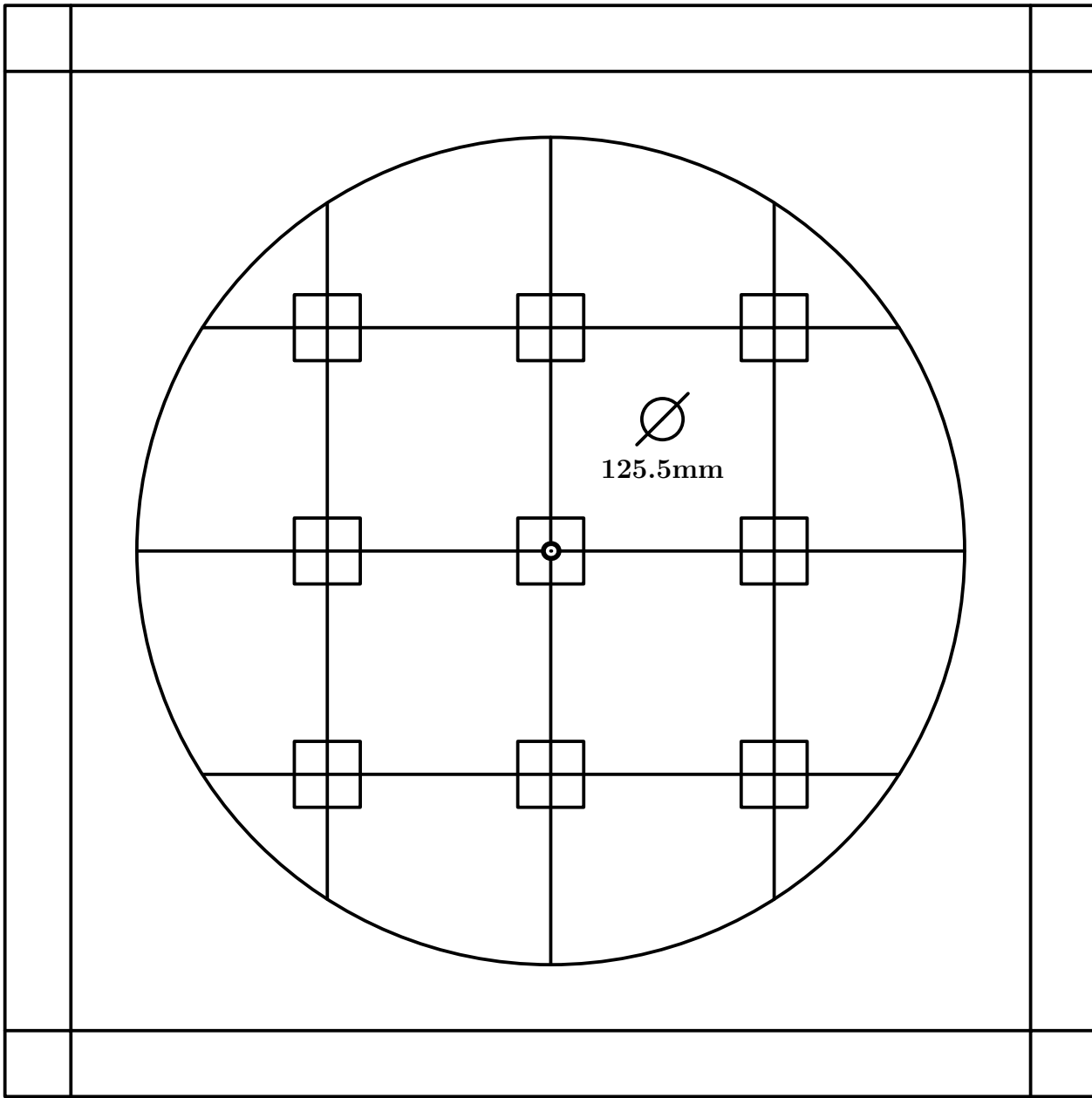

Fig. 103

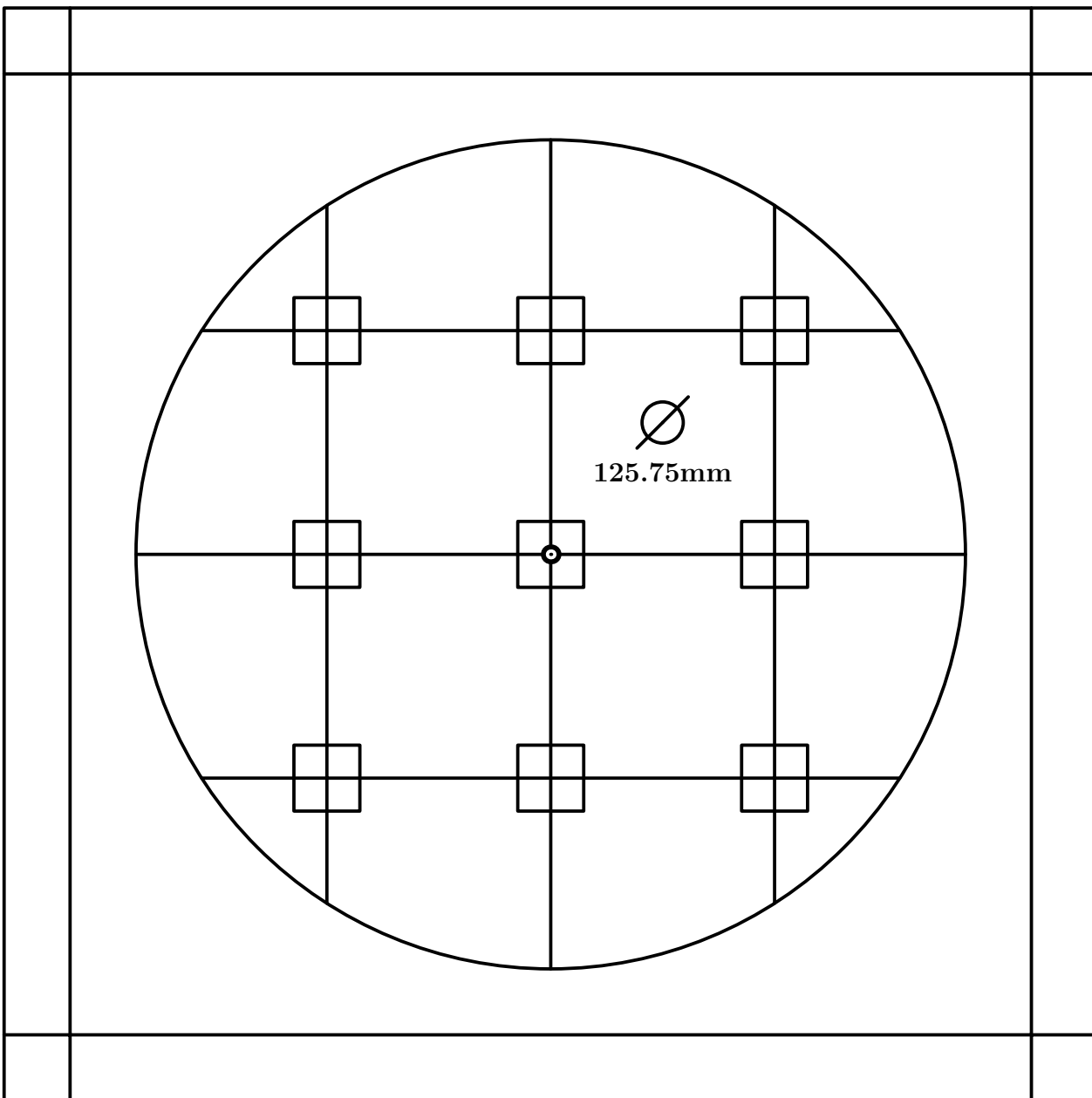

Fig. 104

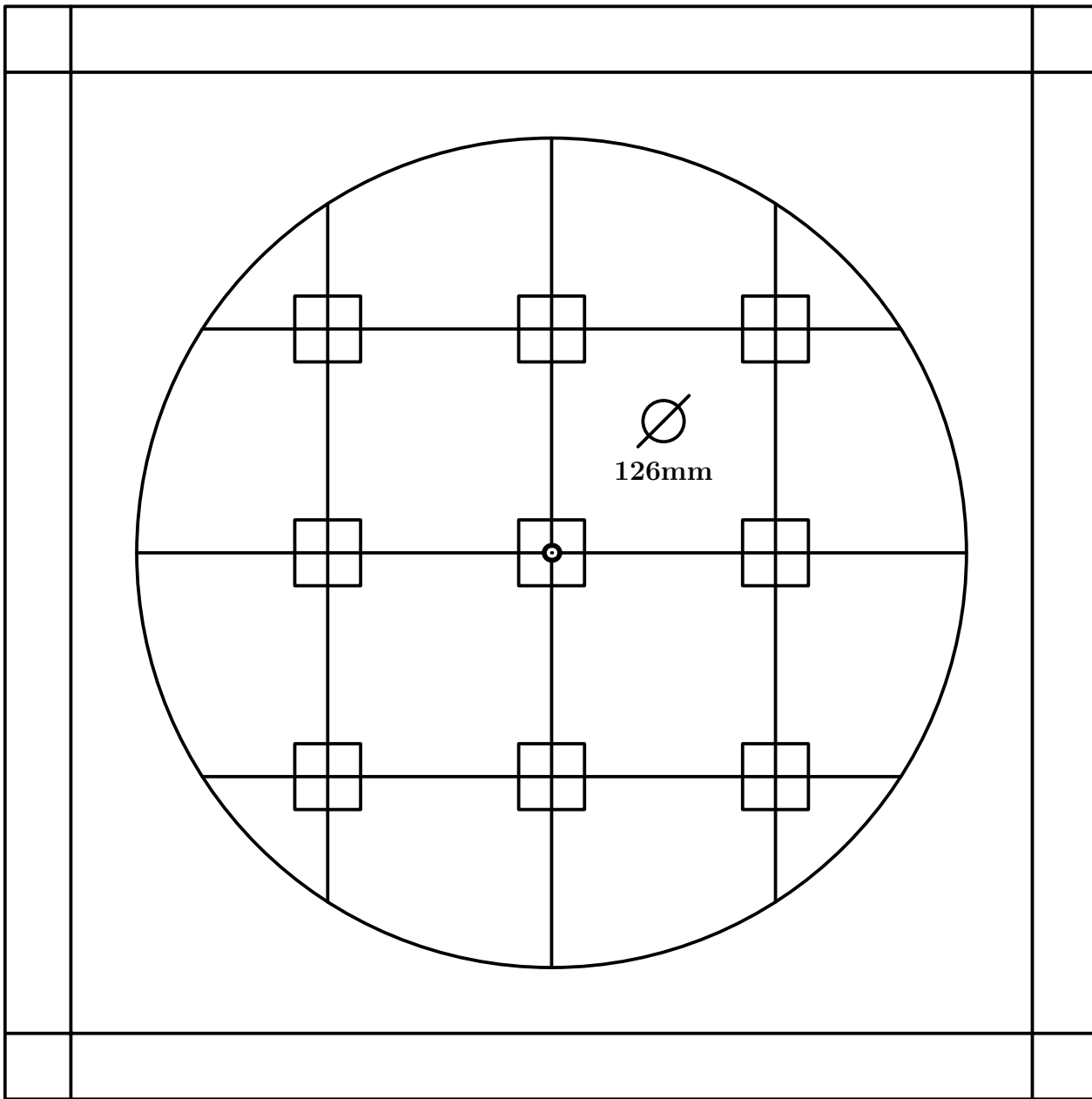

Fig. 105

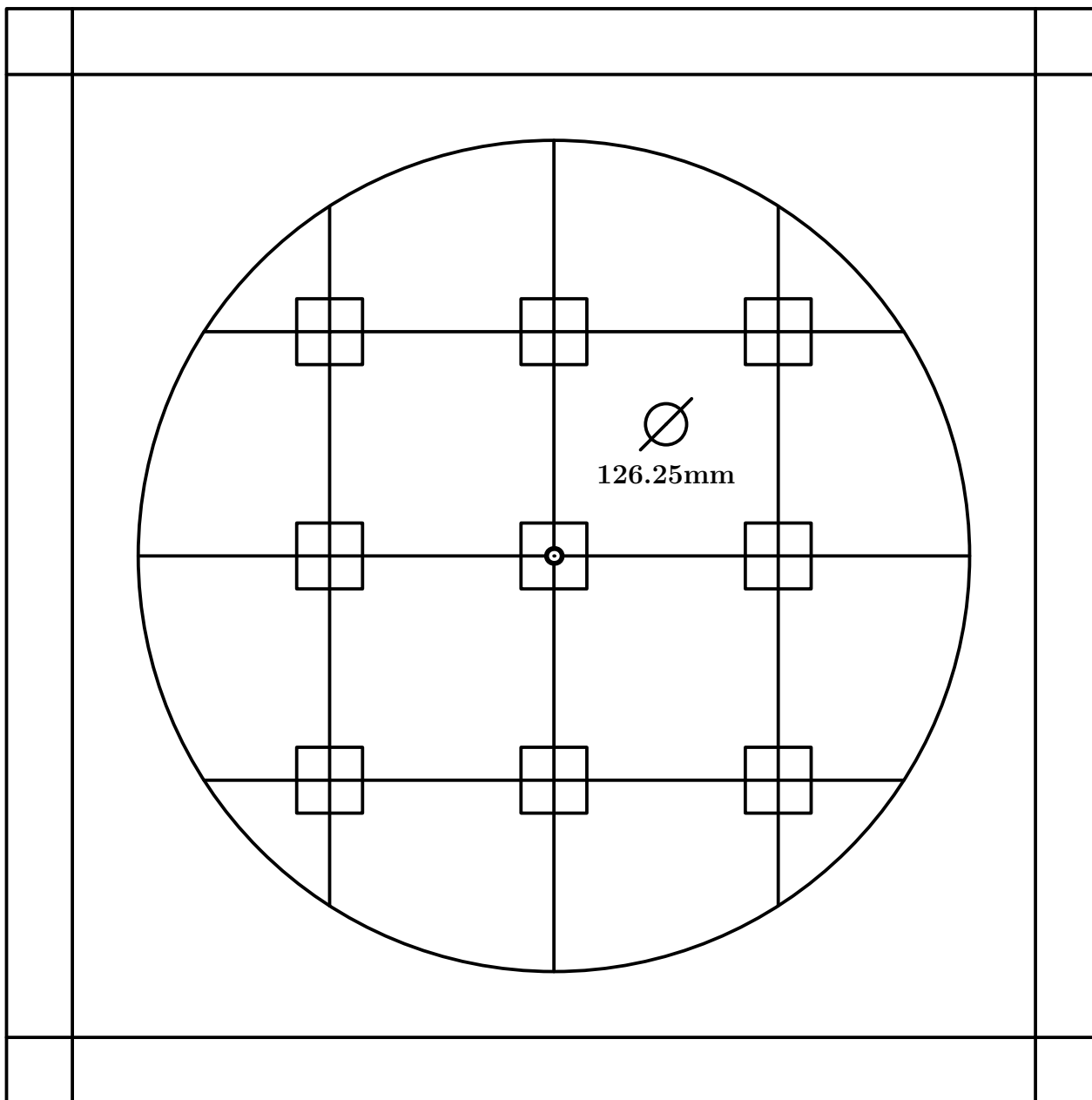

Fig. 106

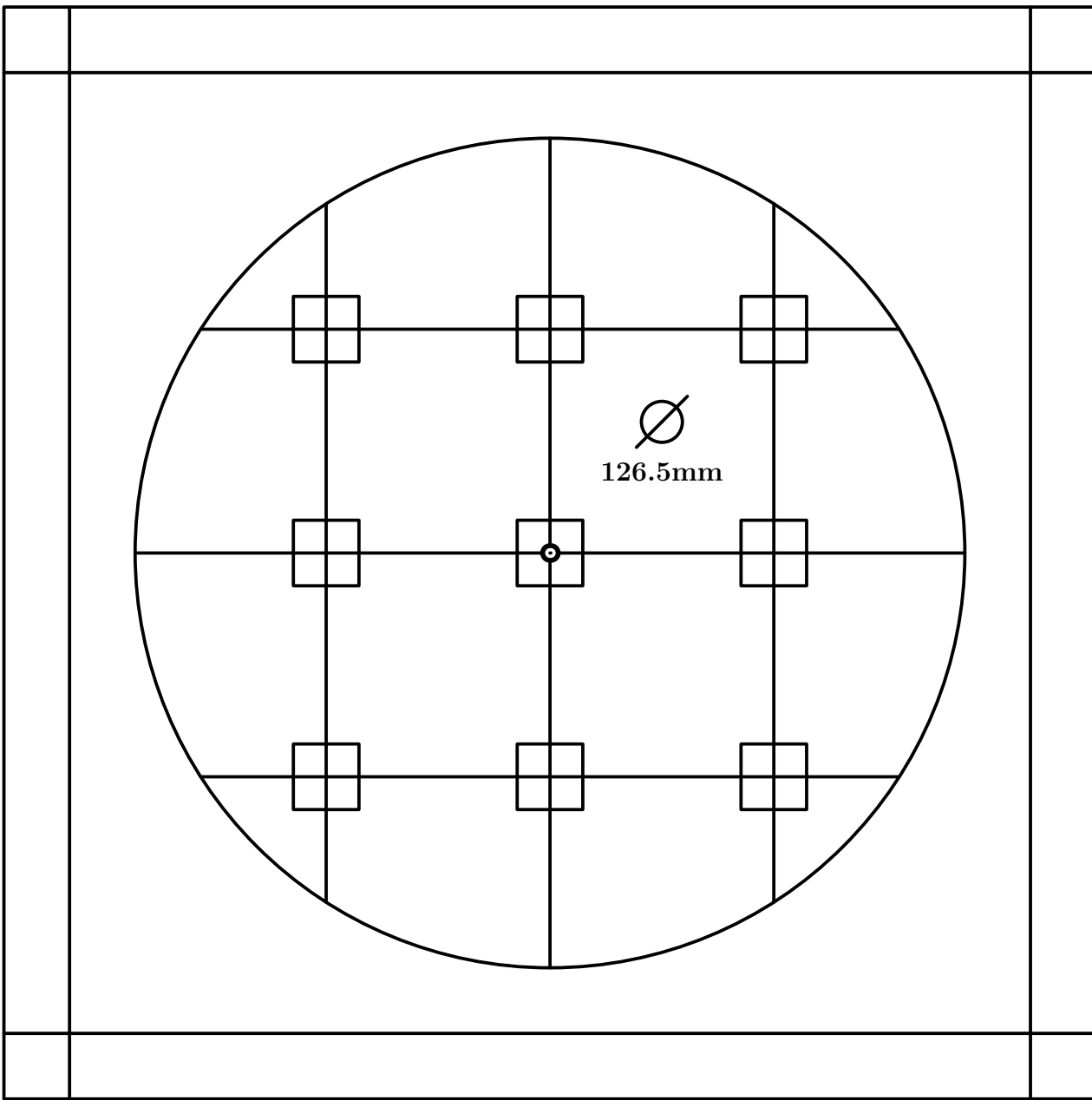

Fig. 107

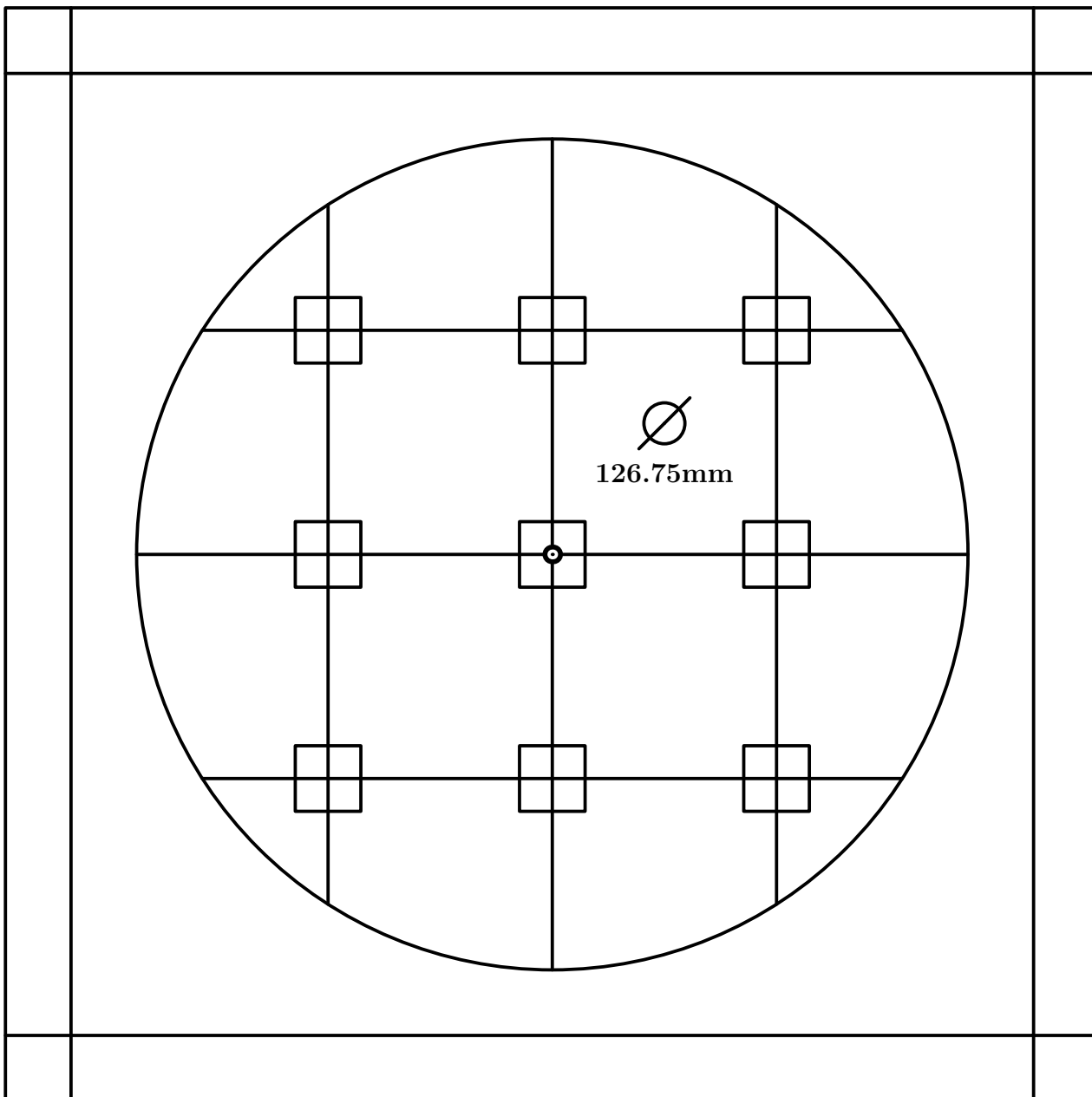

Fig. 108

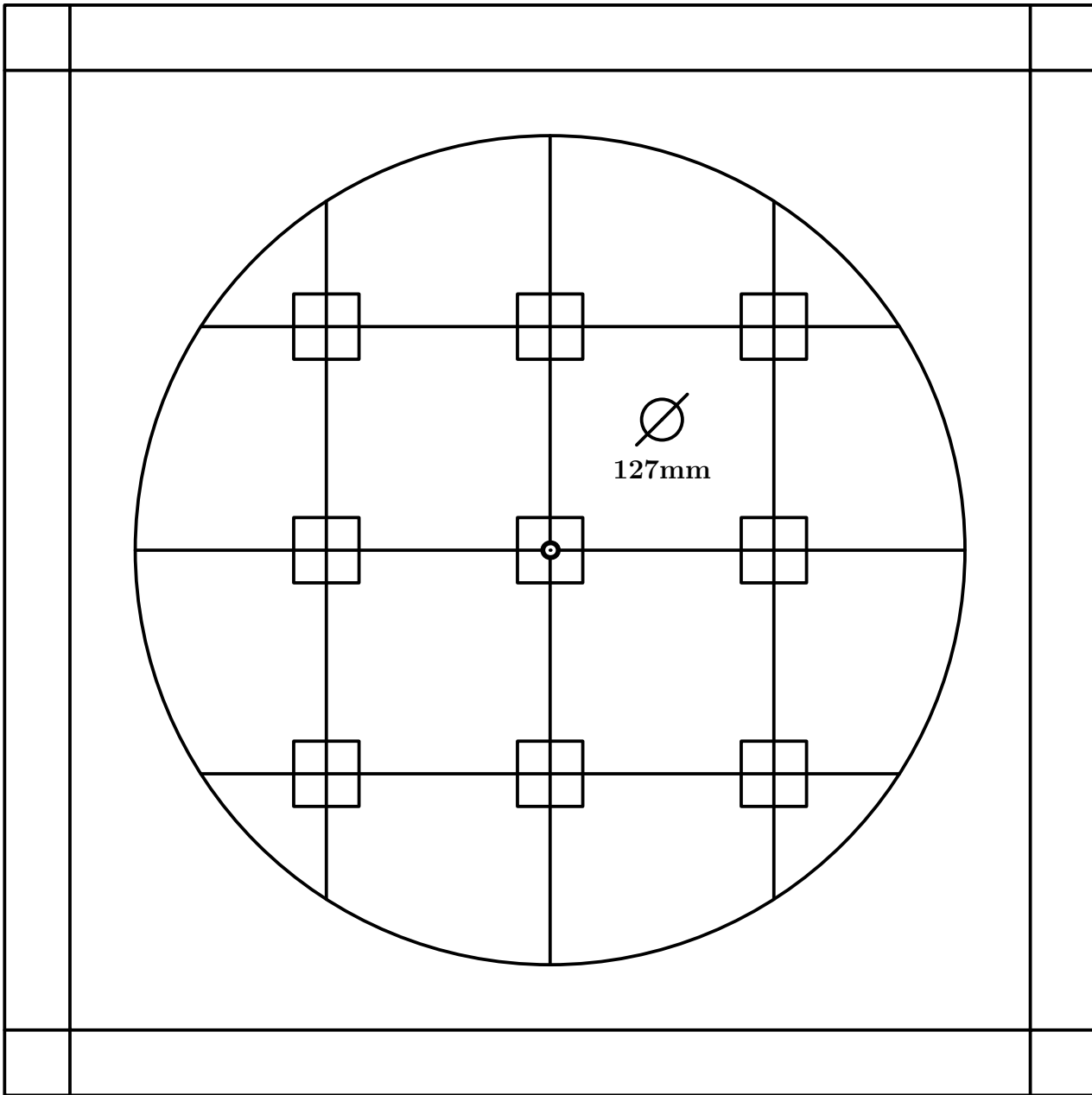

Fig. 109

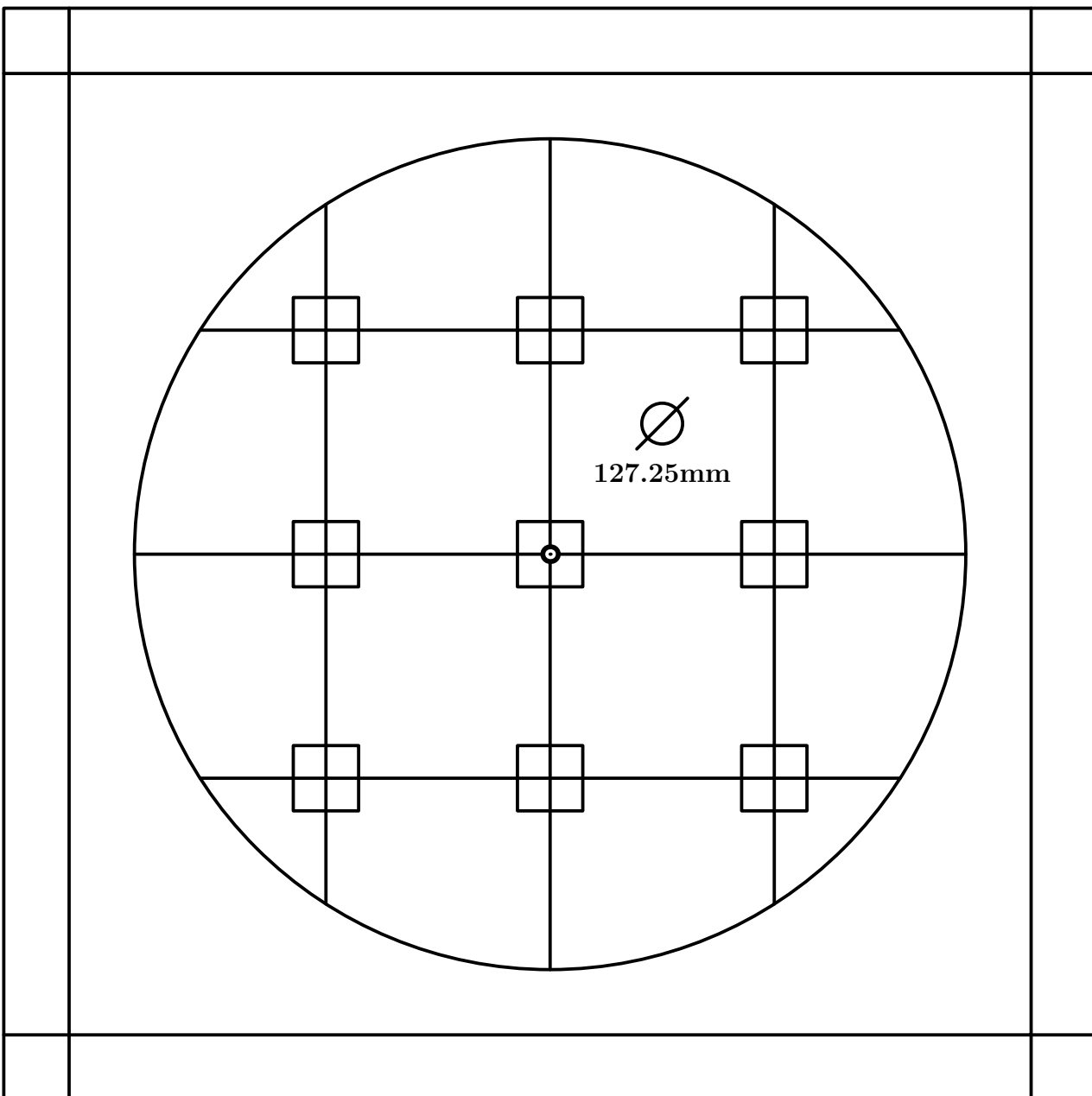

Fig. 110

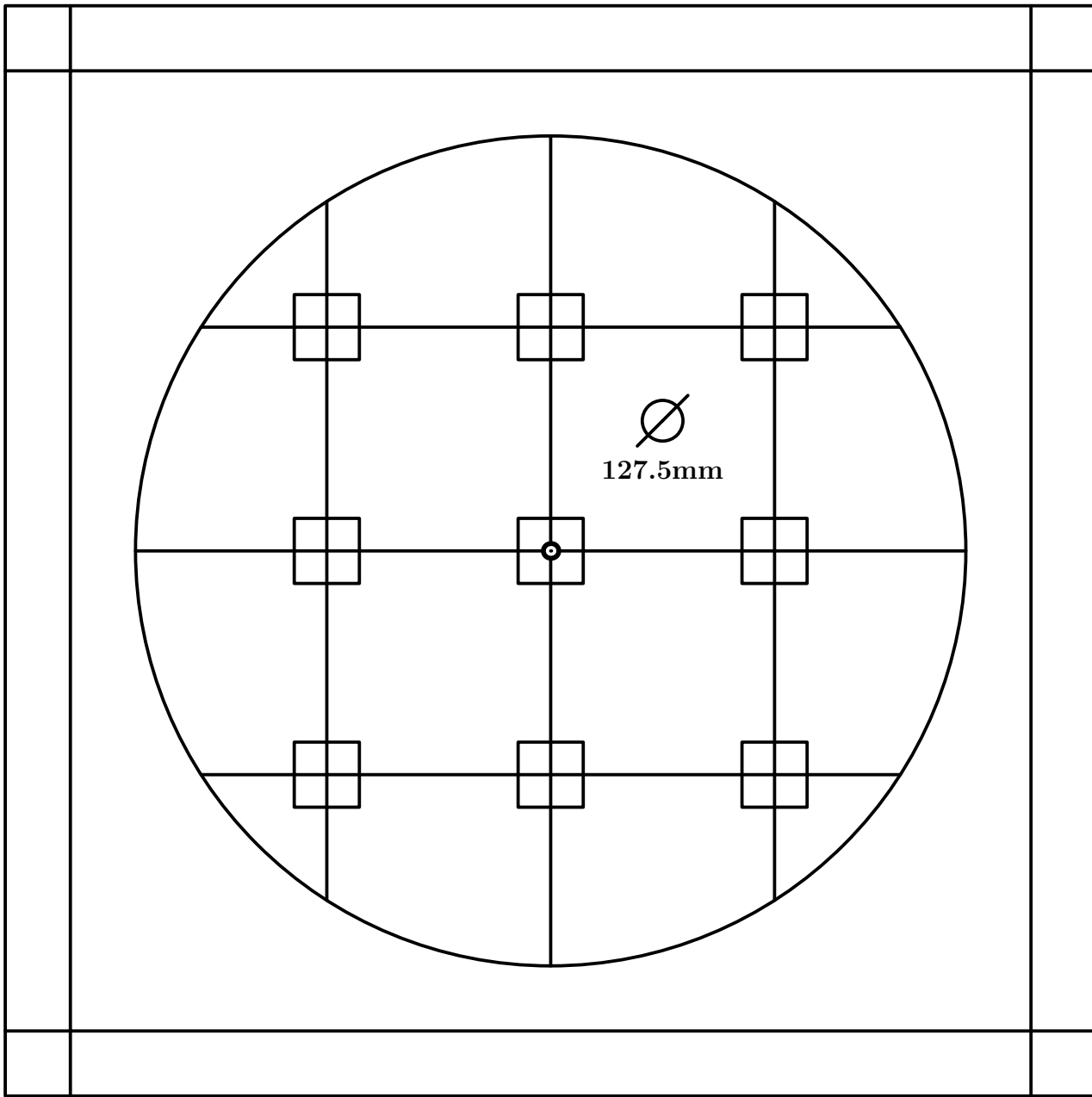

Fig. 111

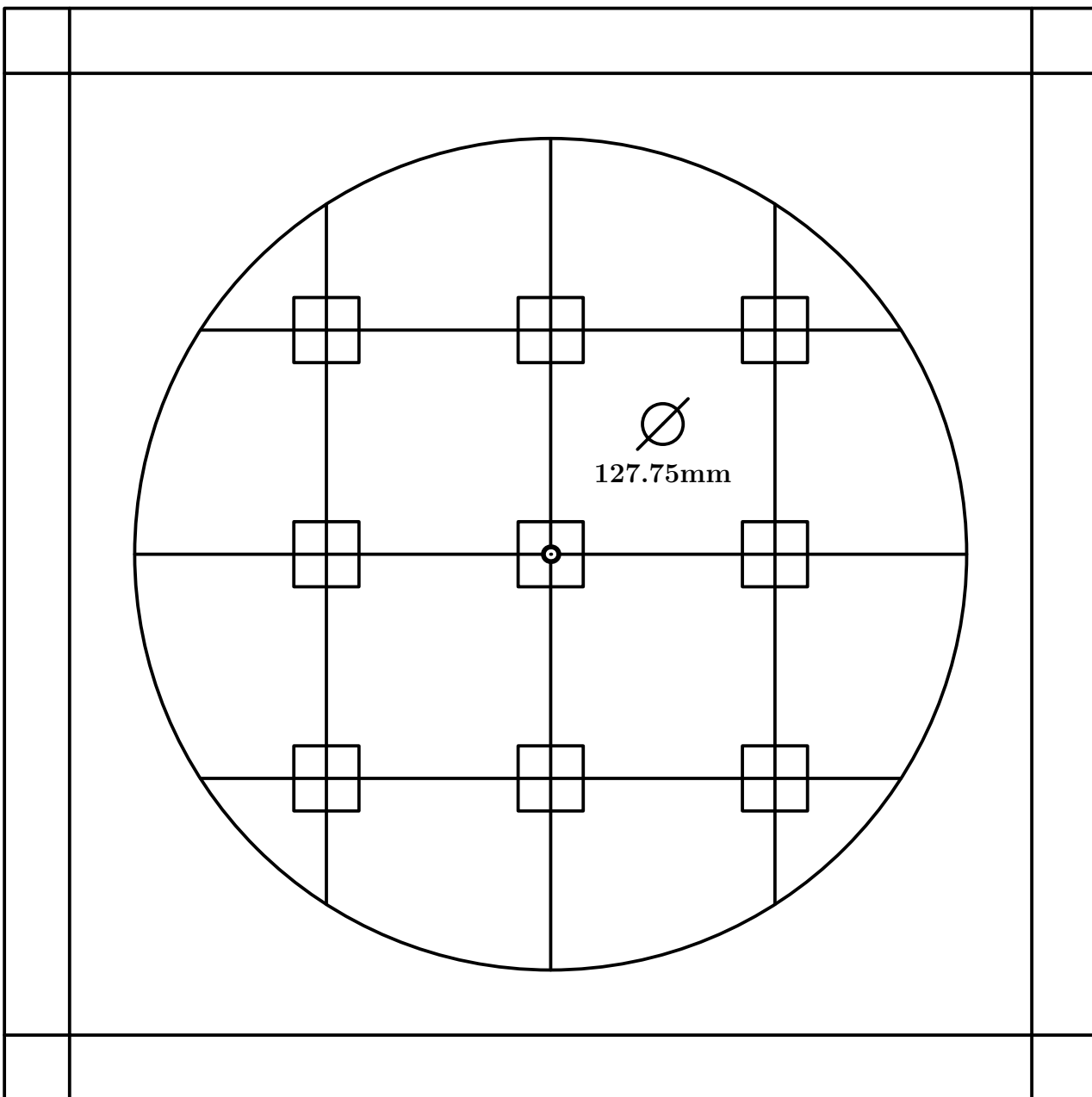

Fig. 112

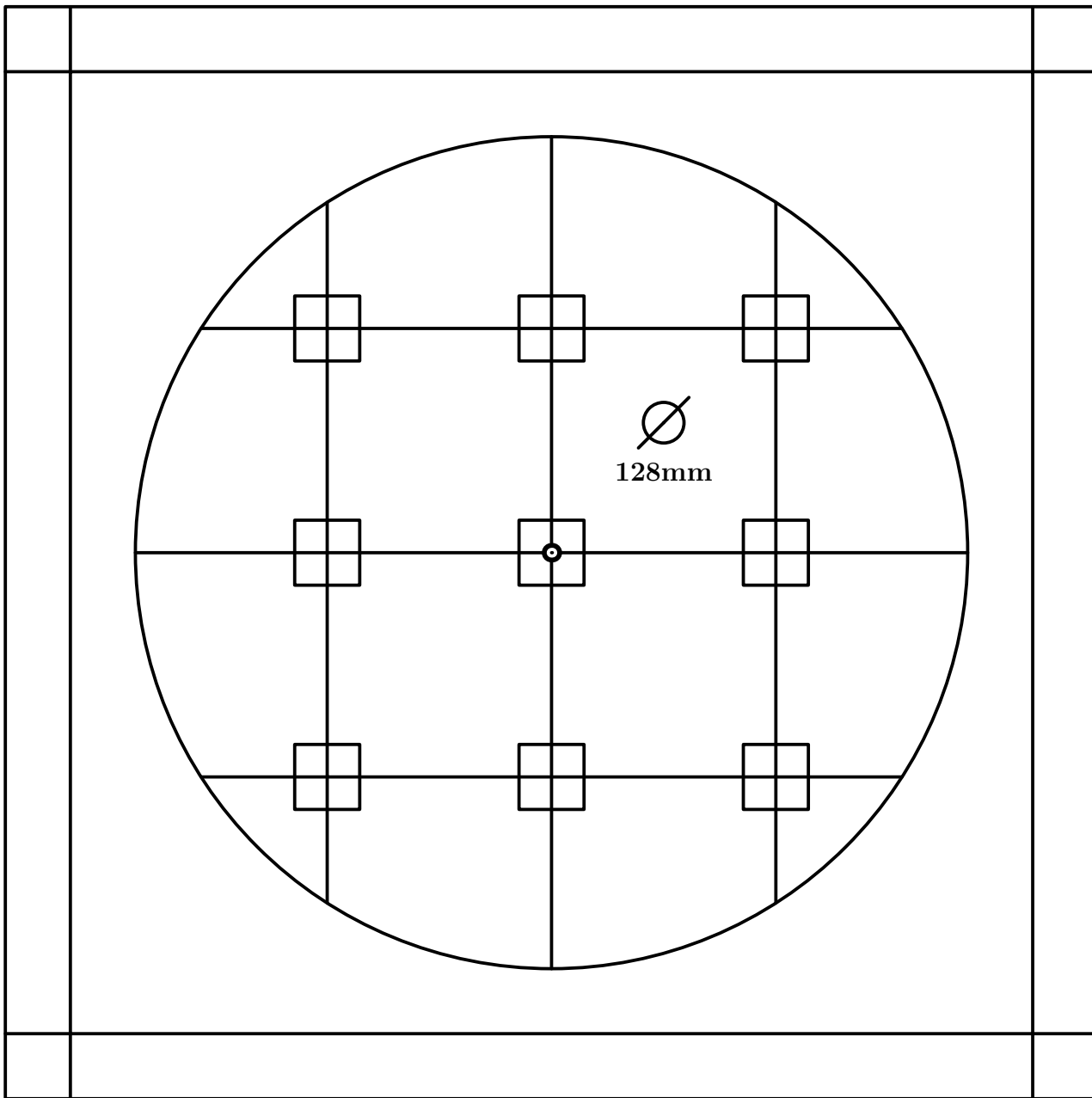

Fig. 113

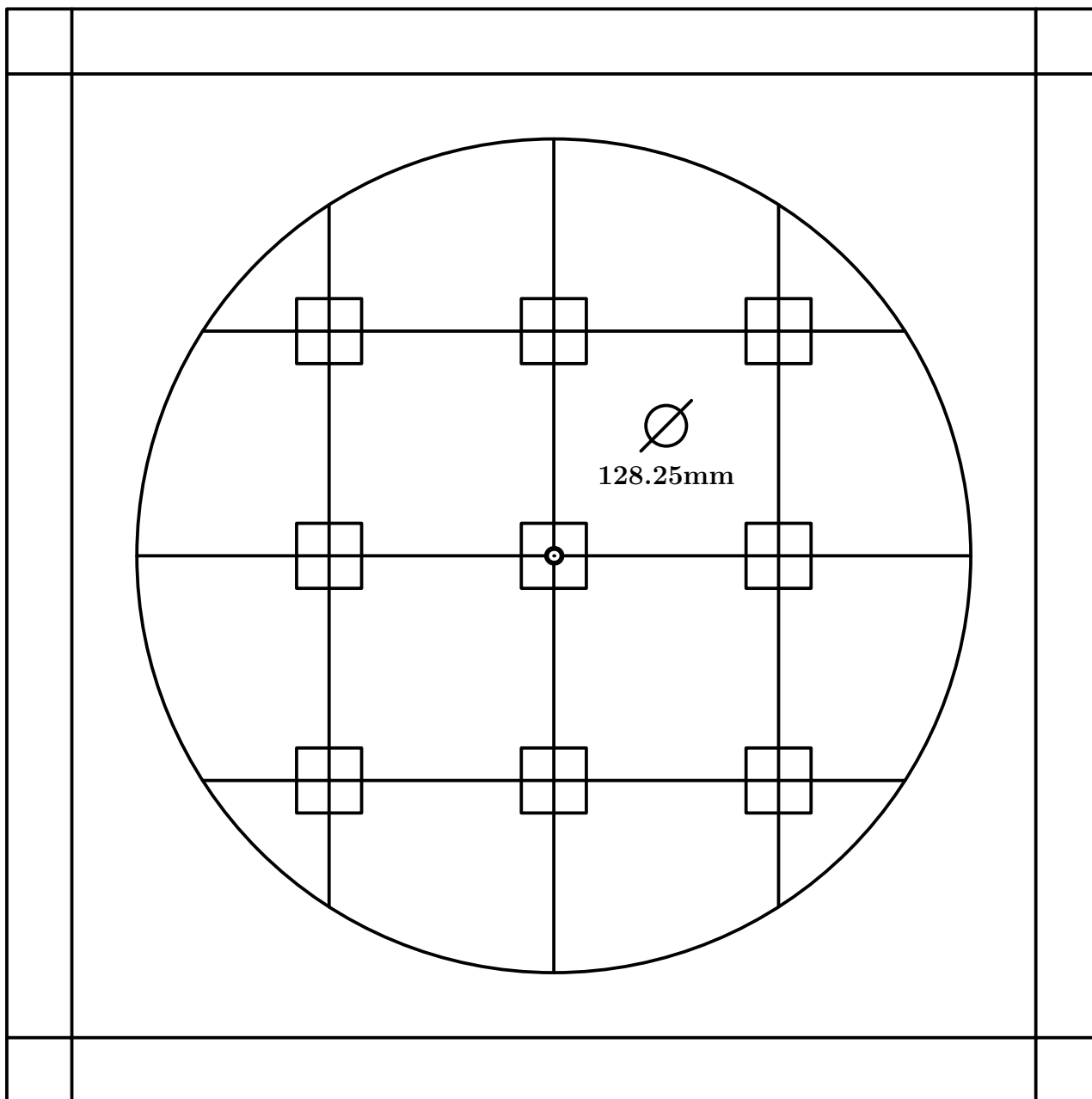

Fig. 114

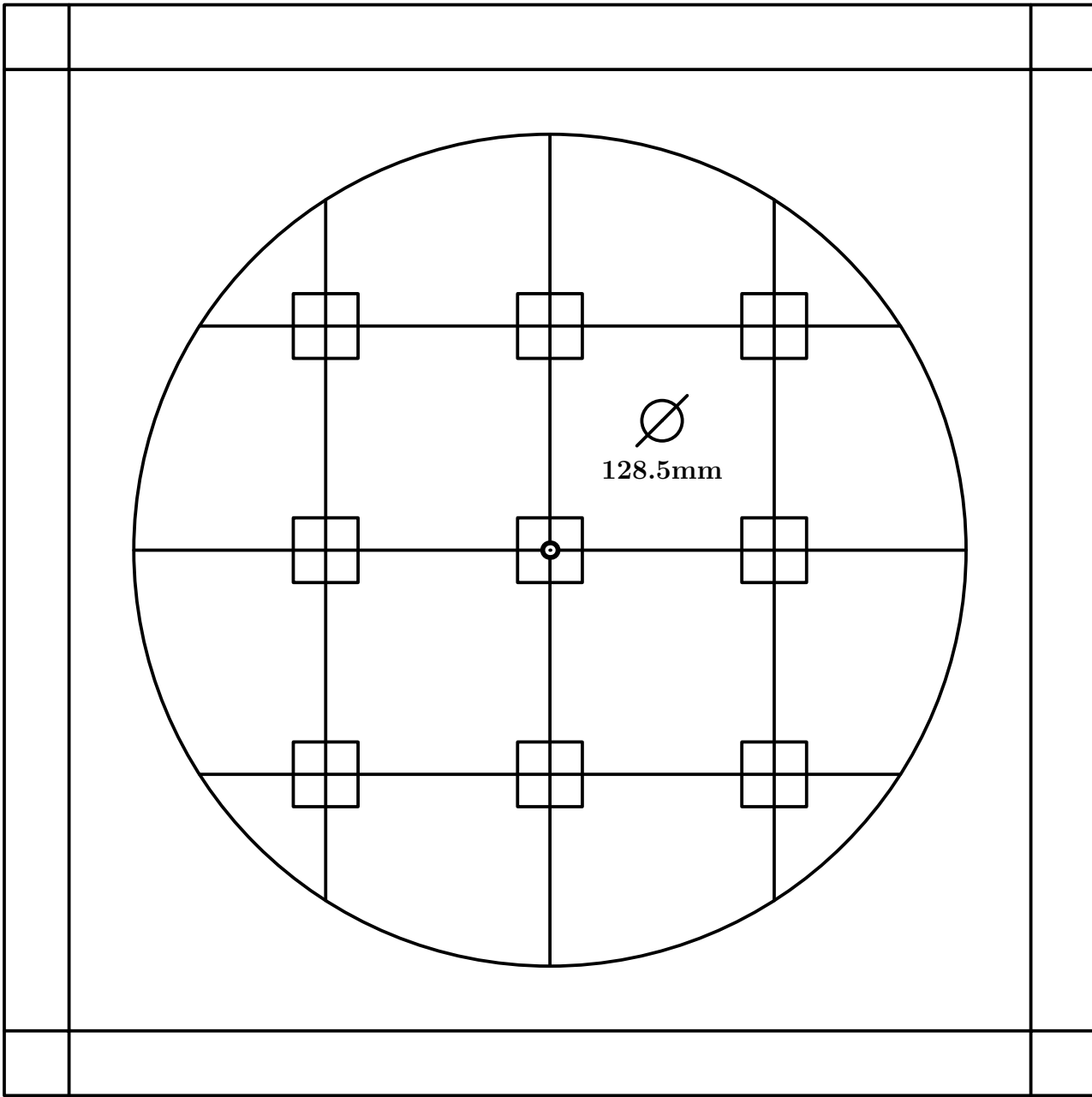

Fig. 115

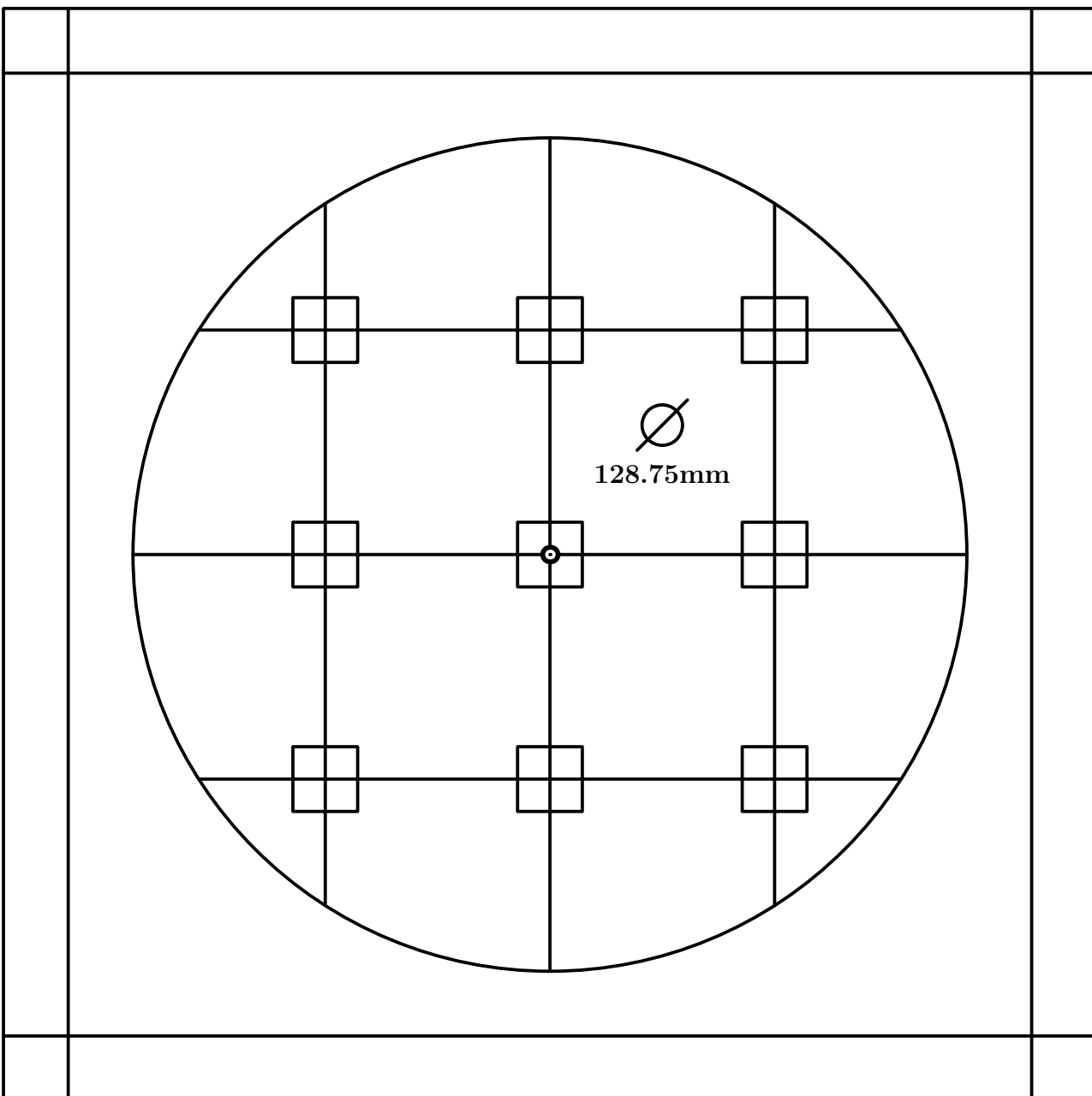

Fig. 116

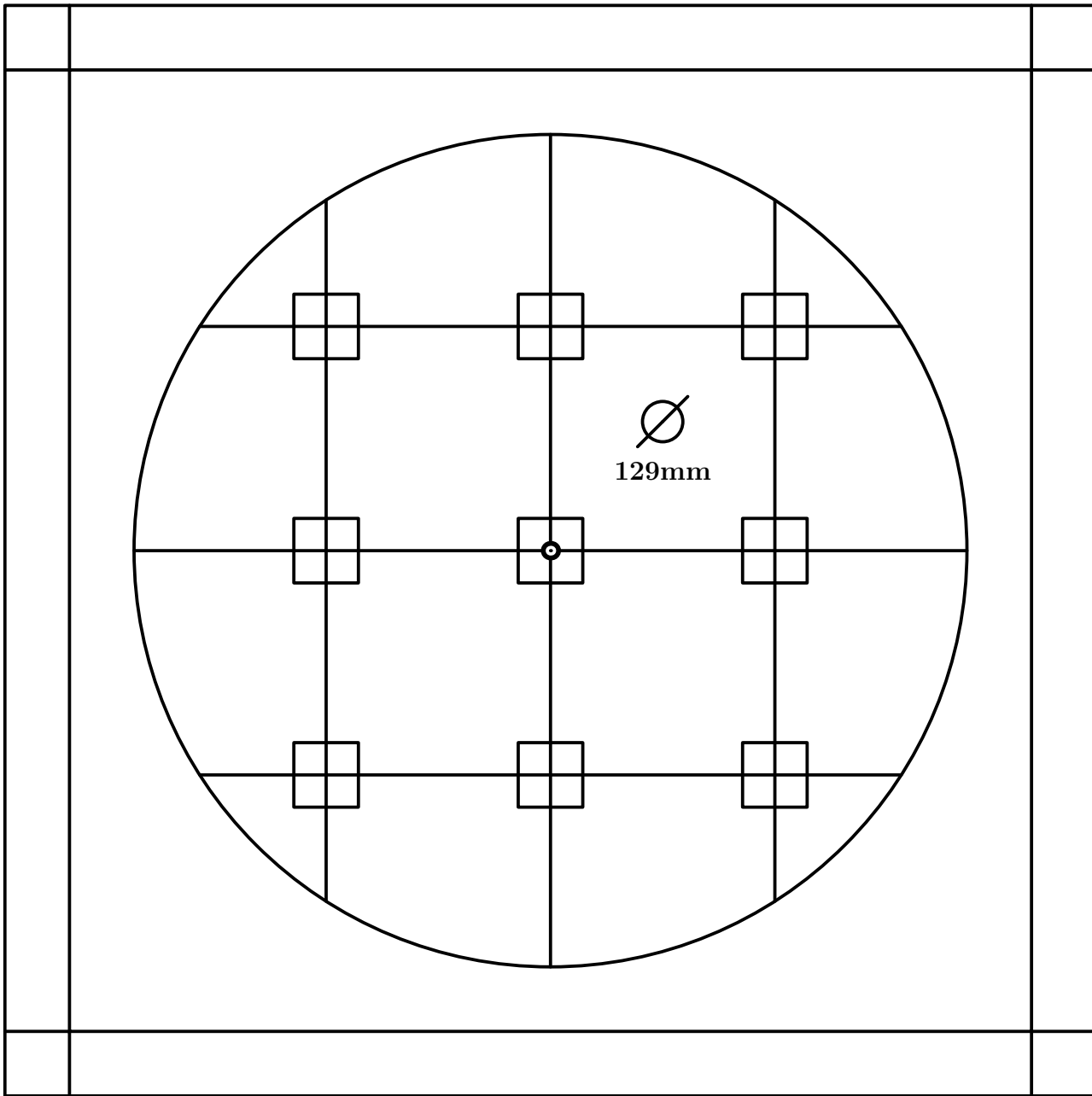

Fig. 117

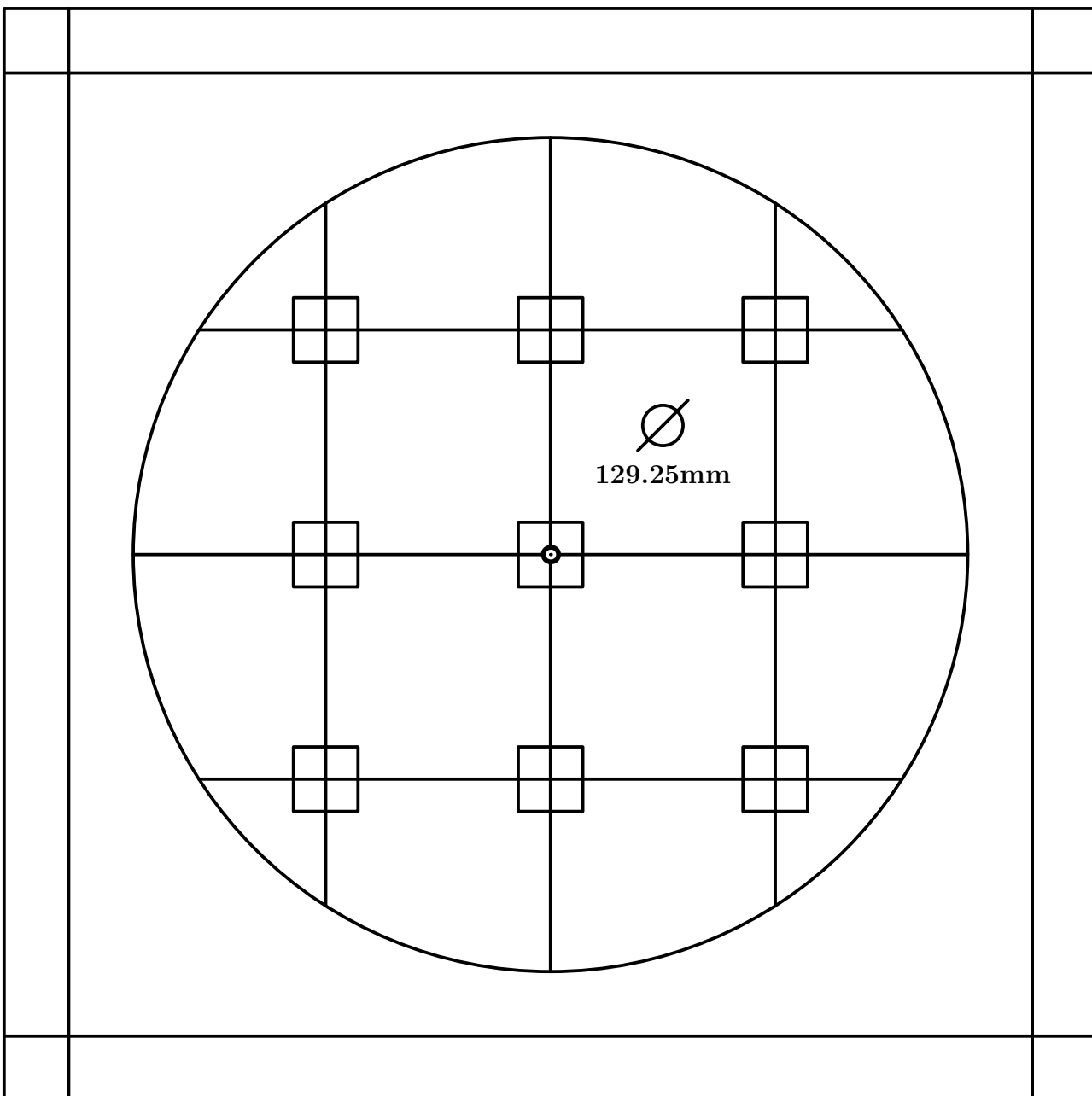

Fig. 118

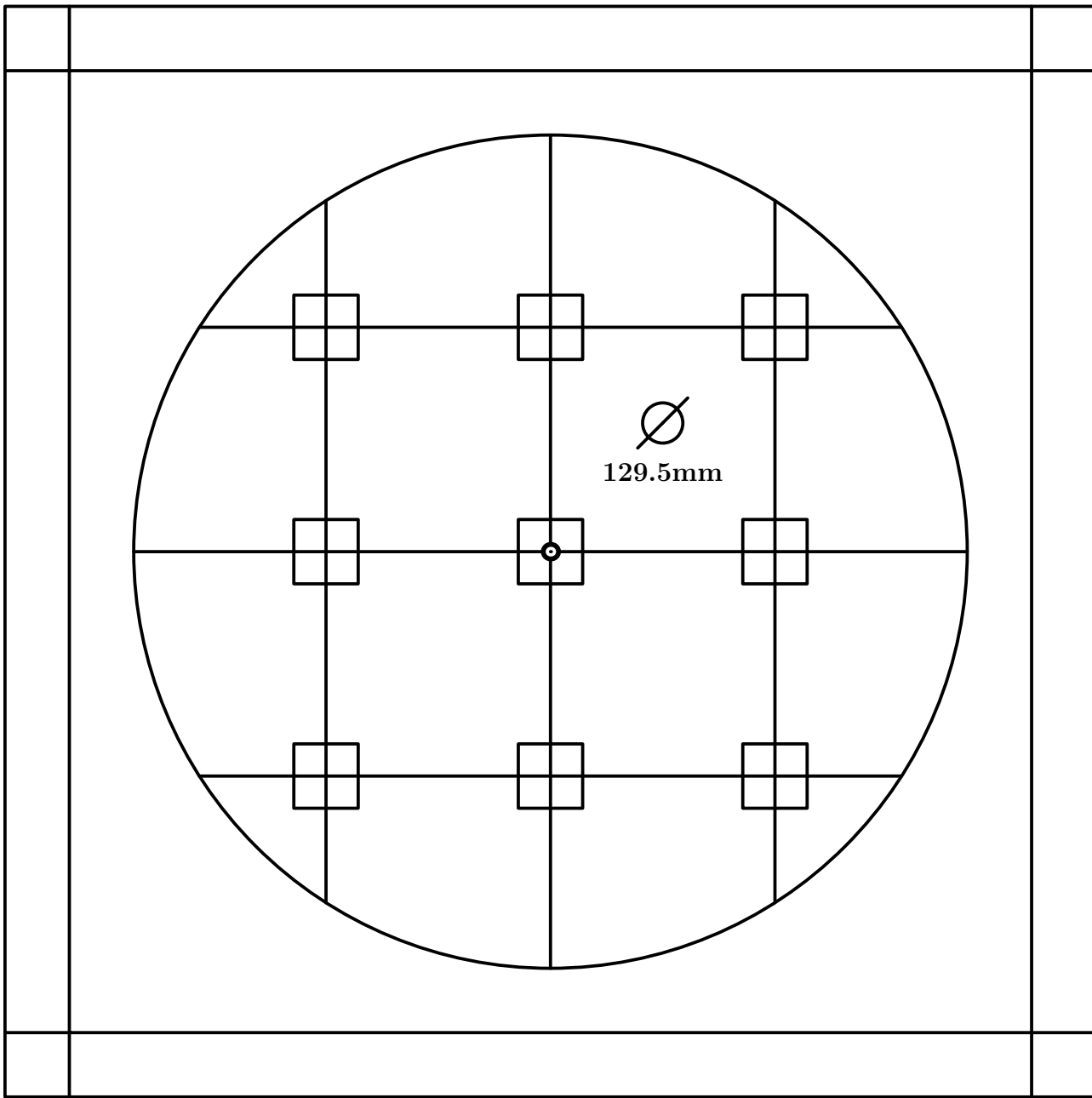

Fig. 119

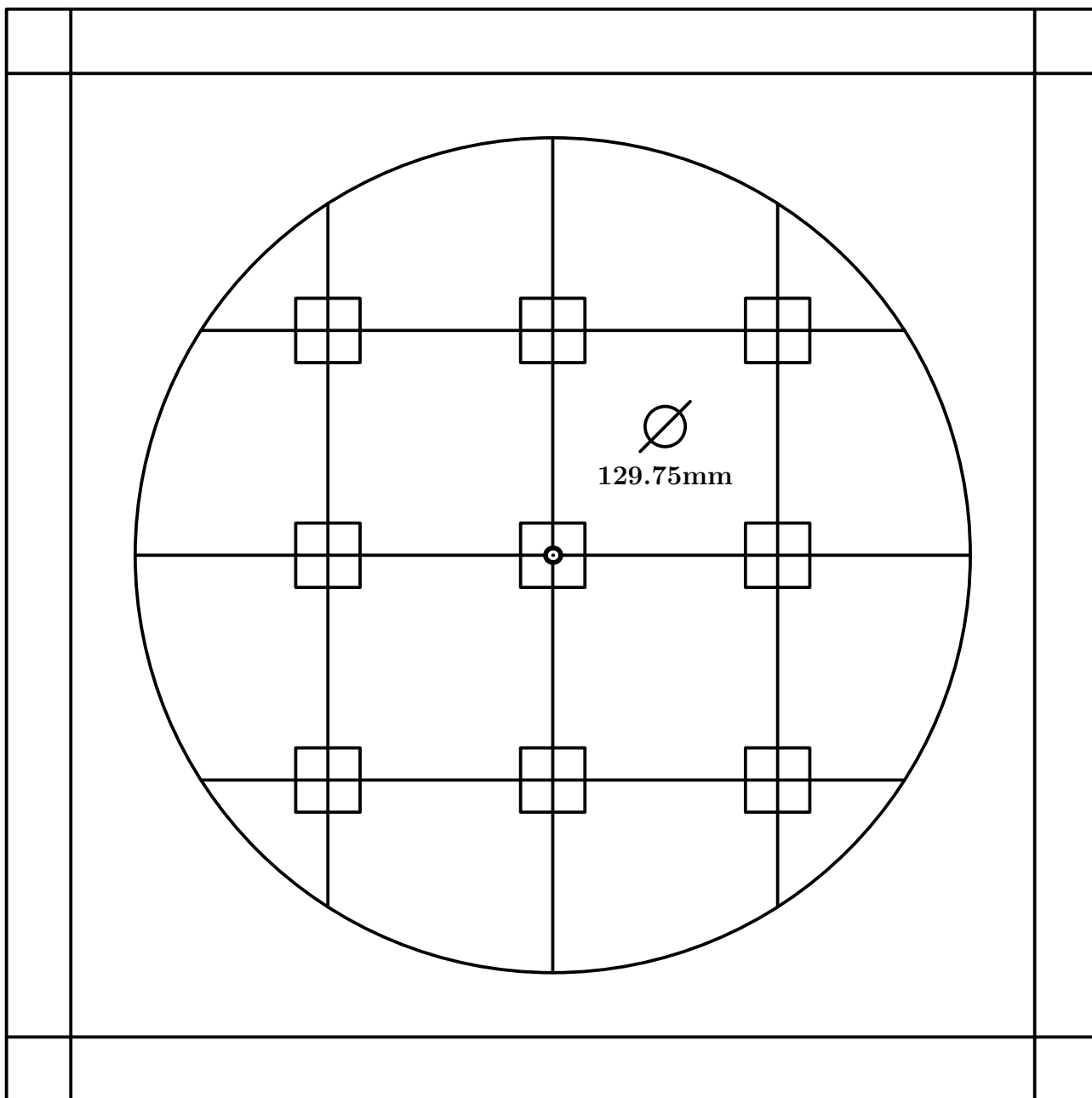

Fig. 120

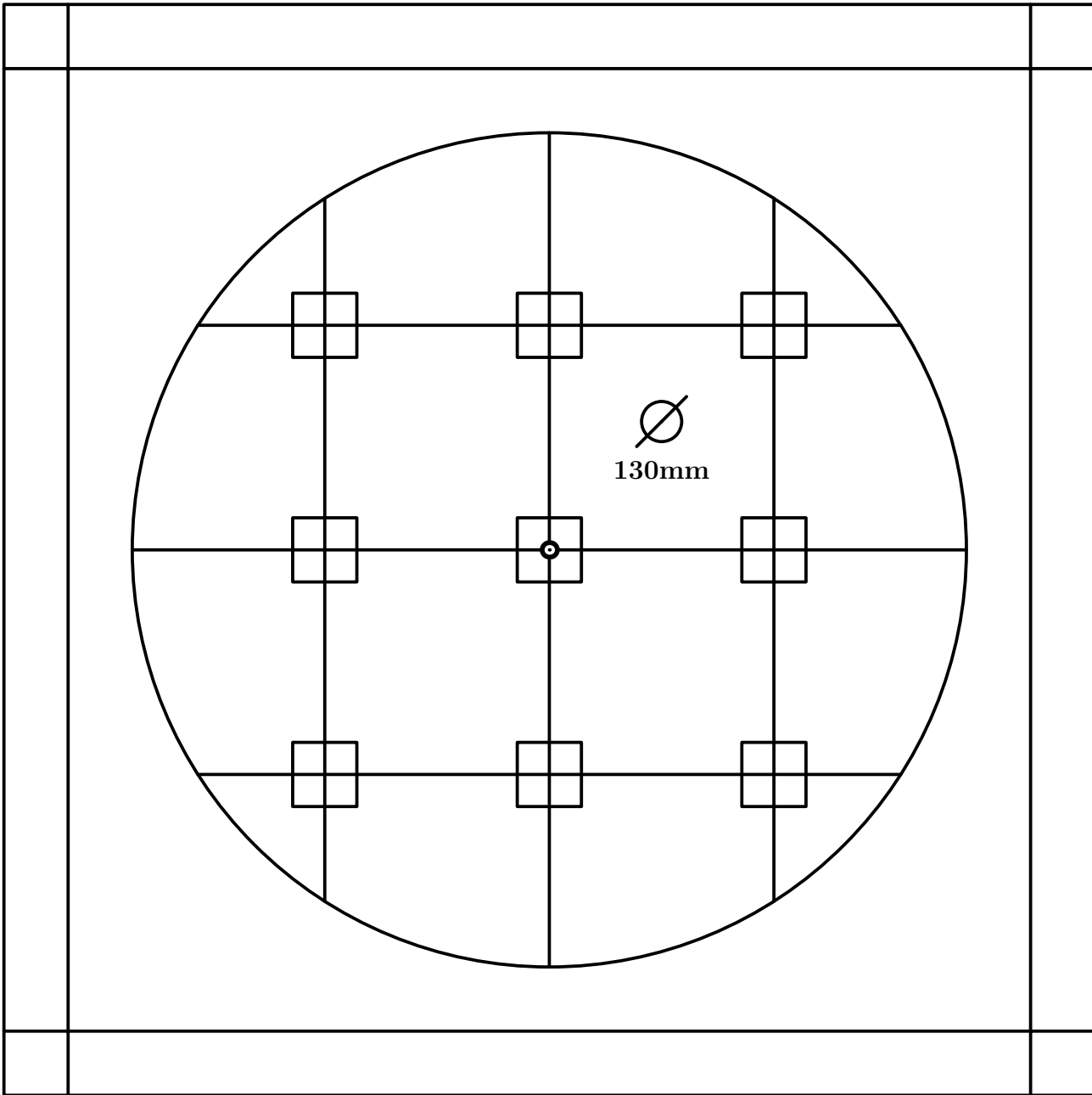

Fig. 121

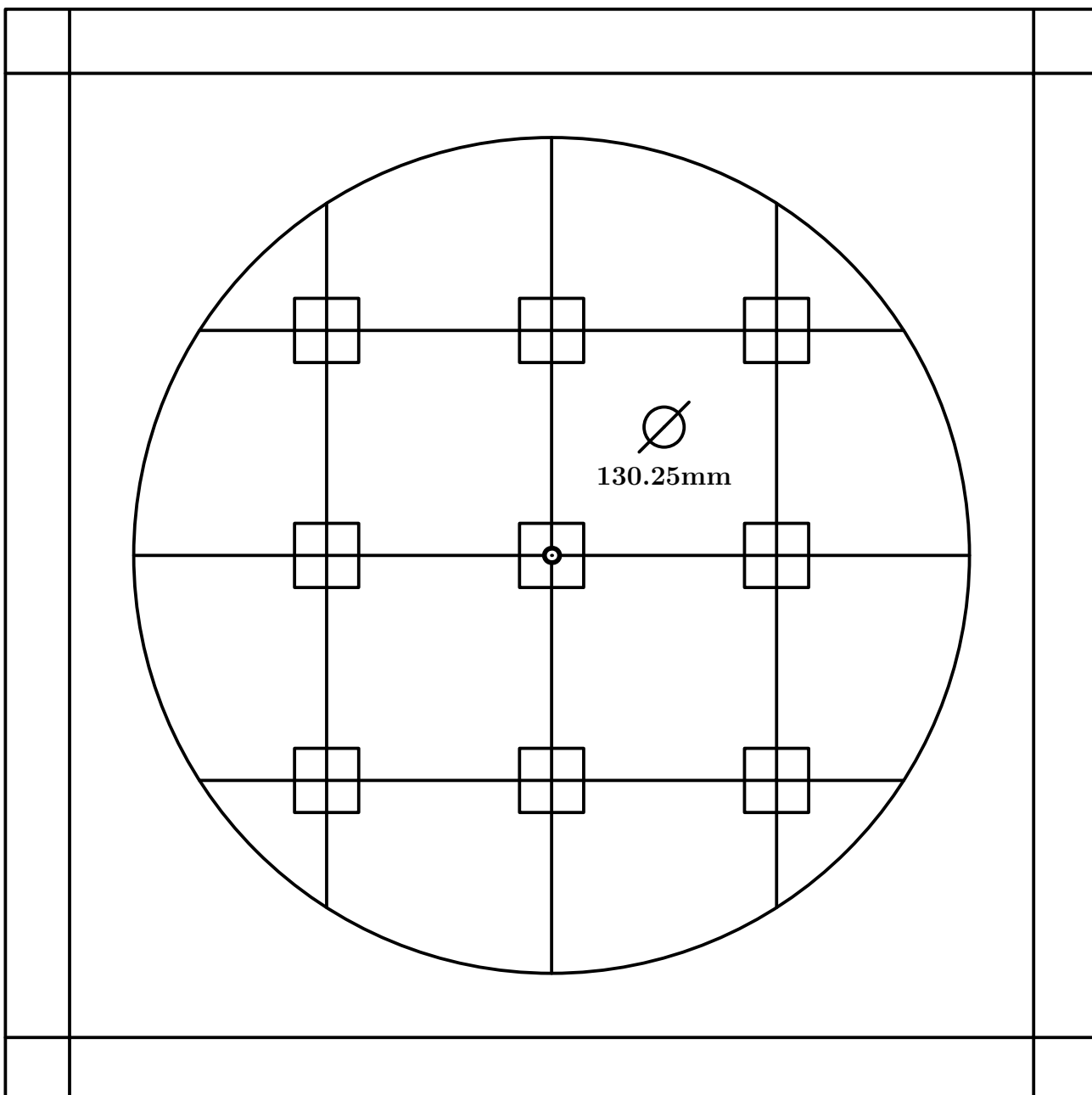

Fig. 122

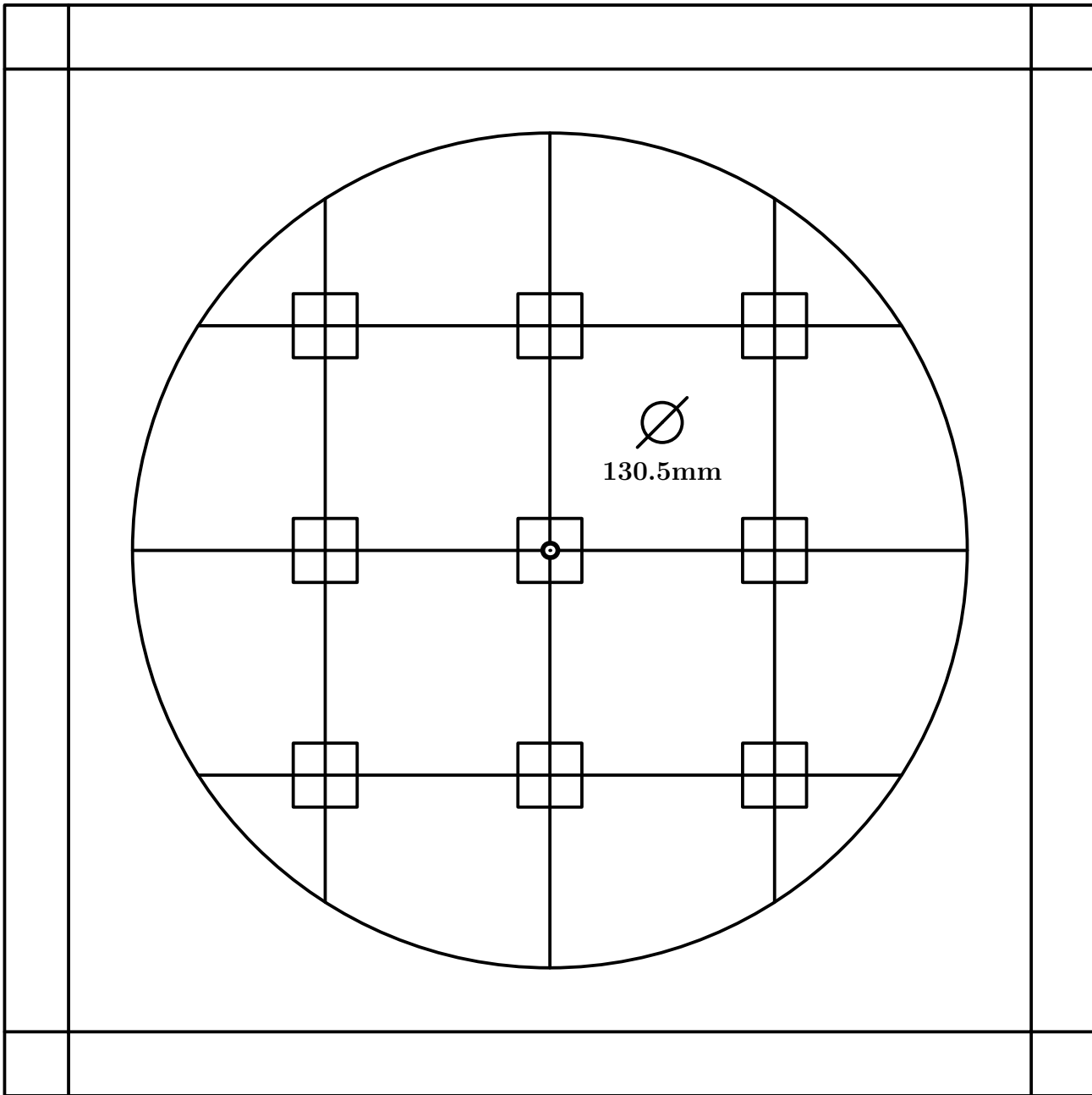

Fig. 123

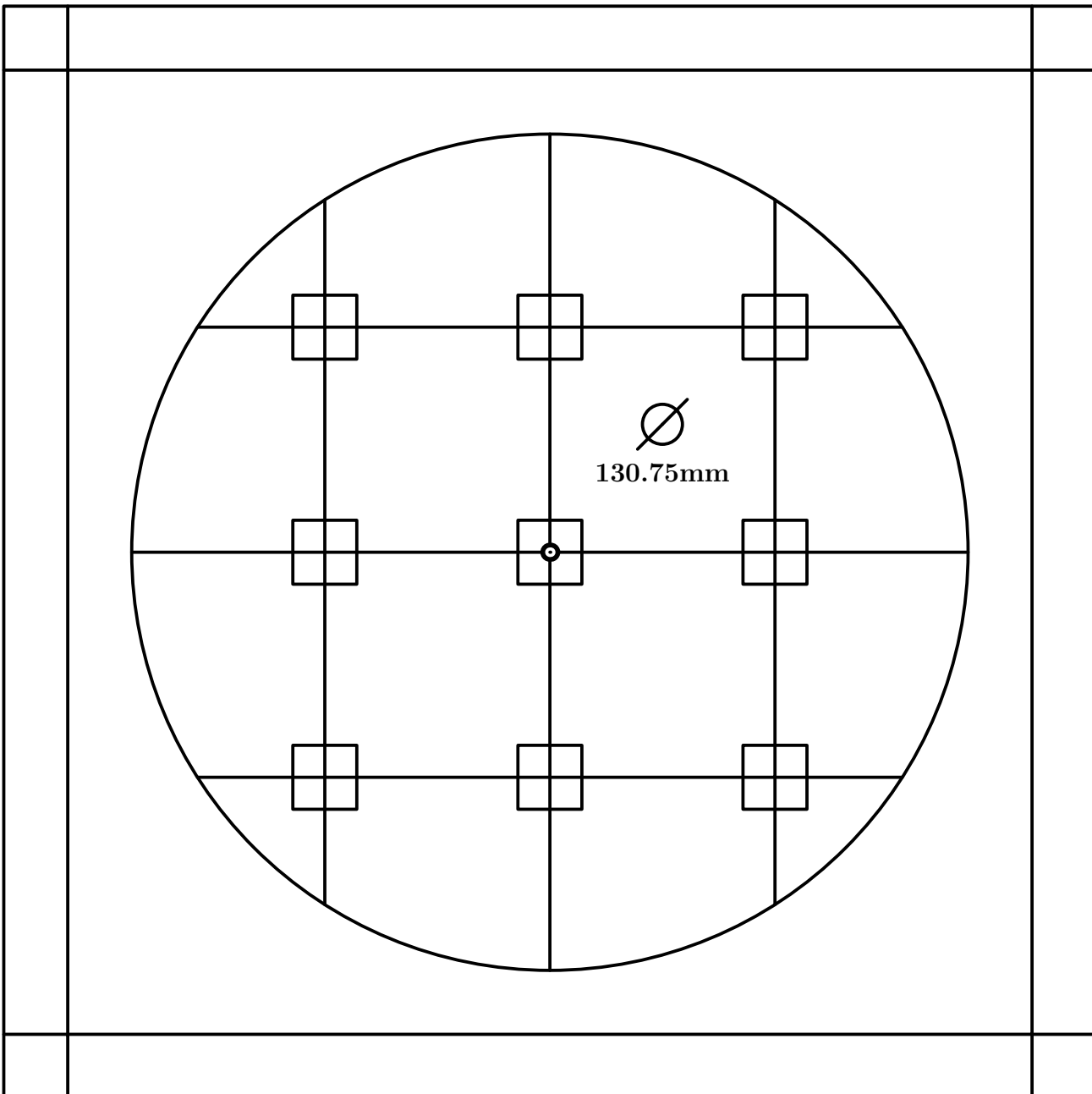

Fig. 124

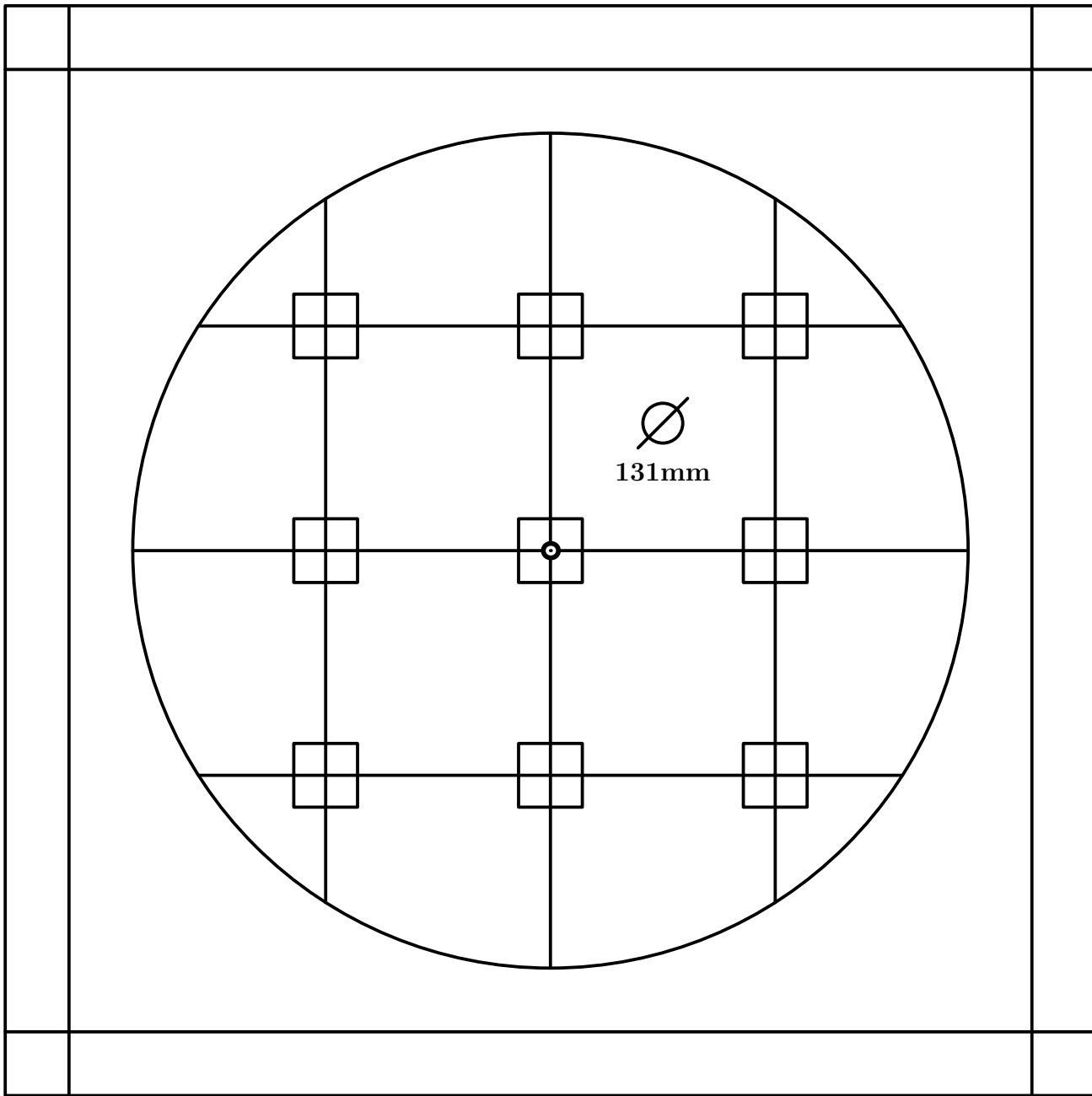

Fig. 125

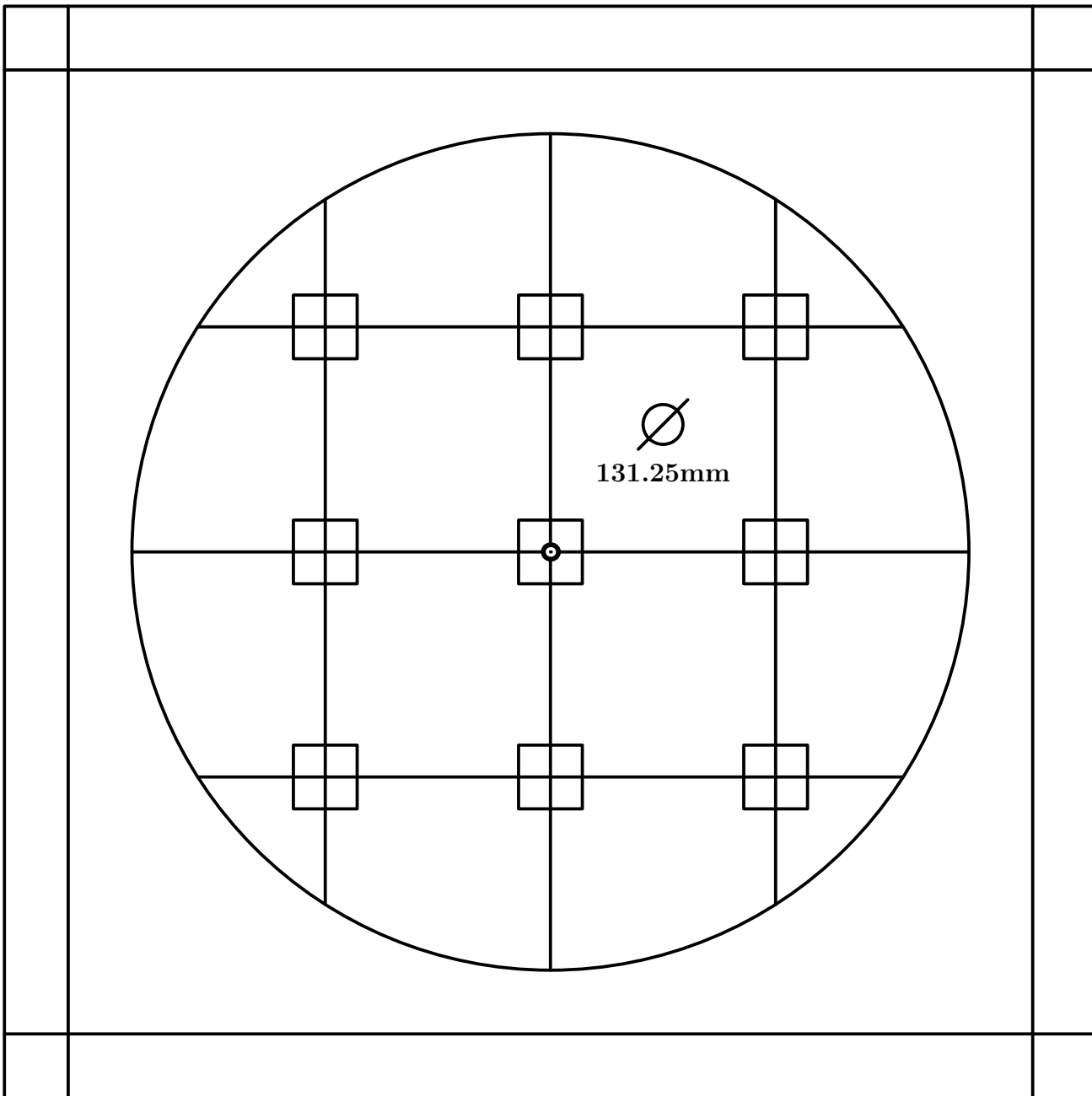

Fig. 126

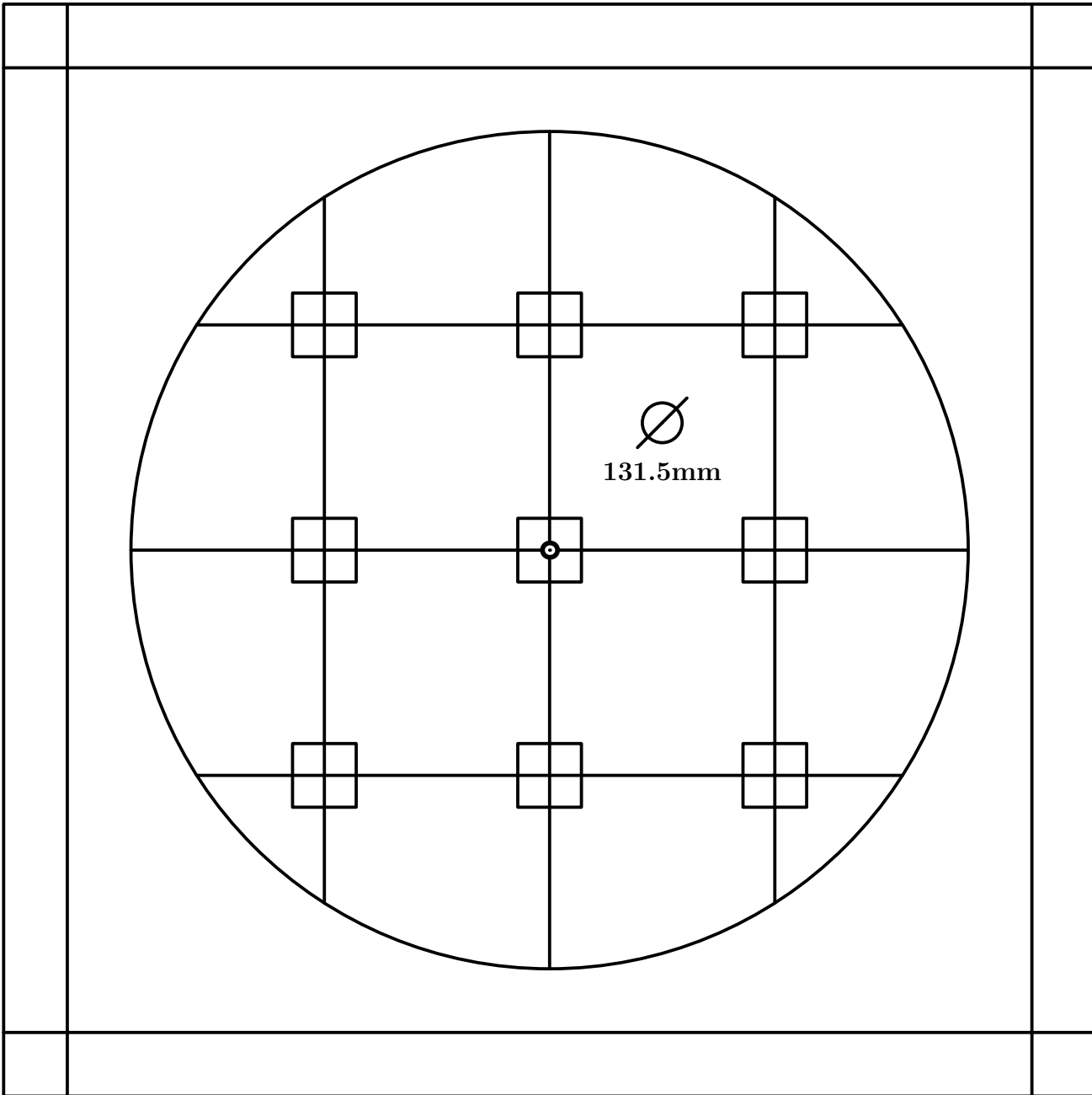

Fig. 127

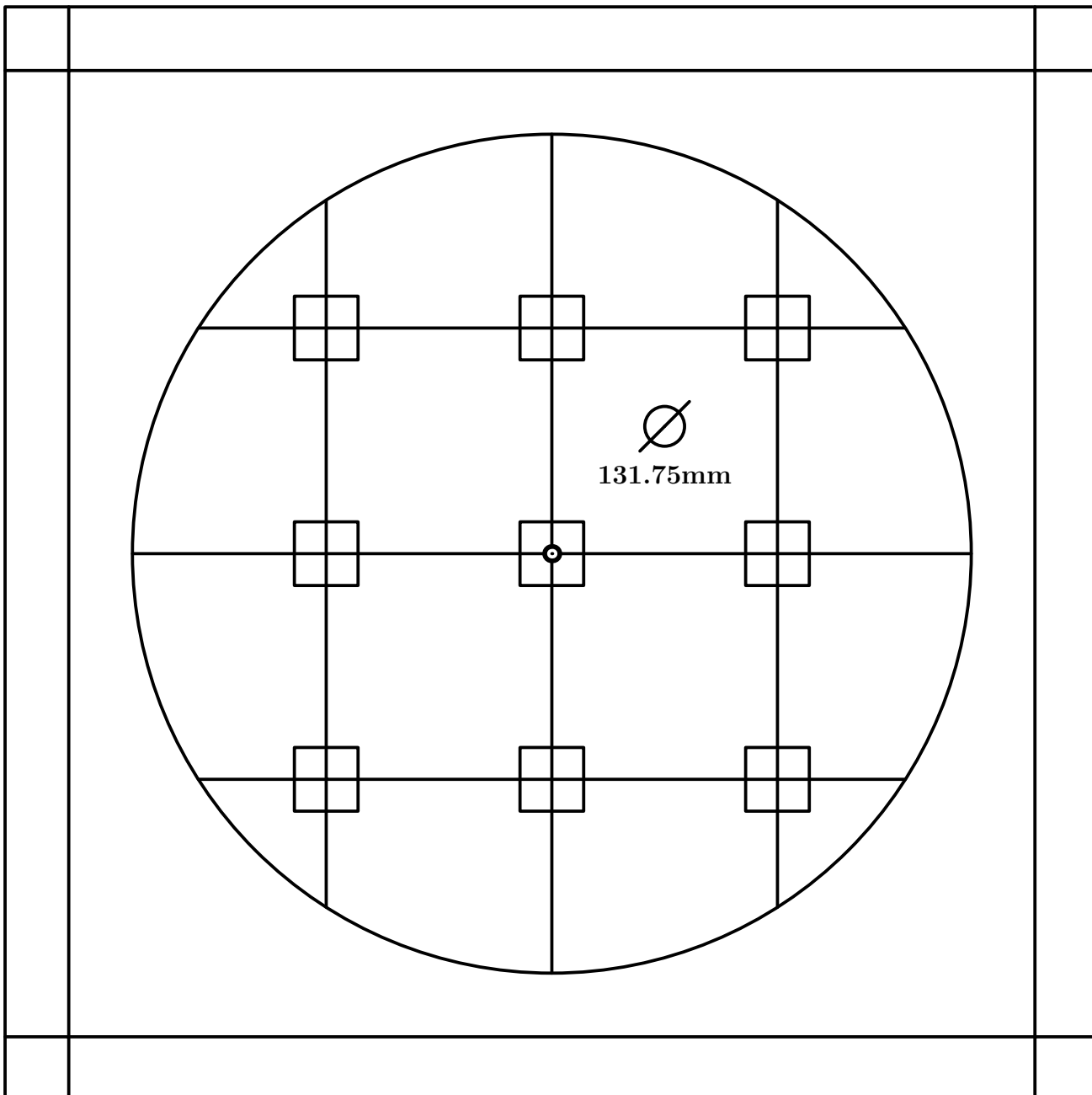

Fig. 128

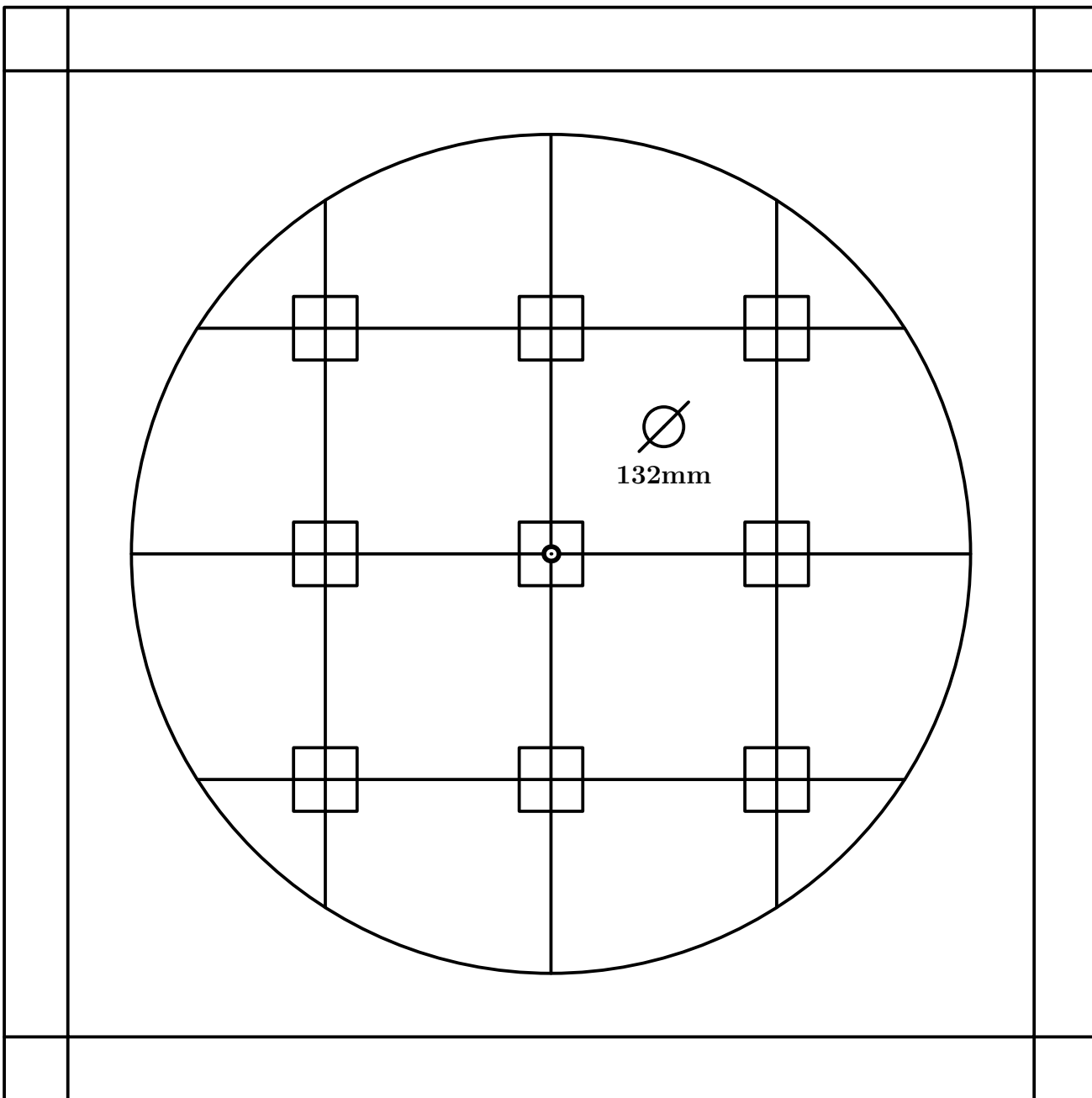

Fig. 129

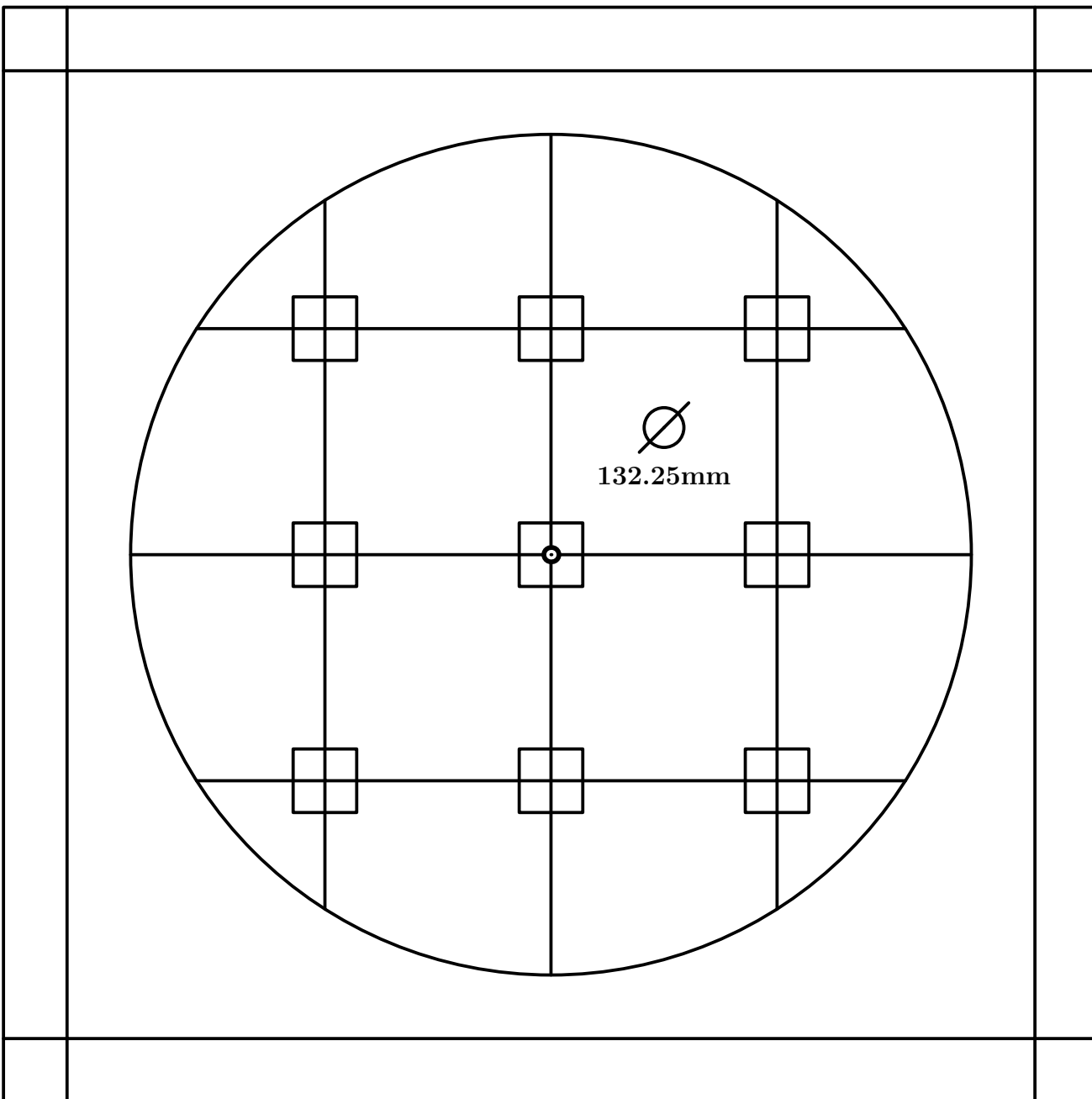

Fig. 130

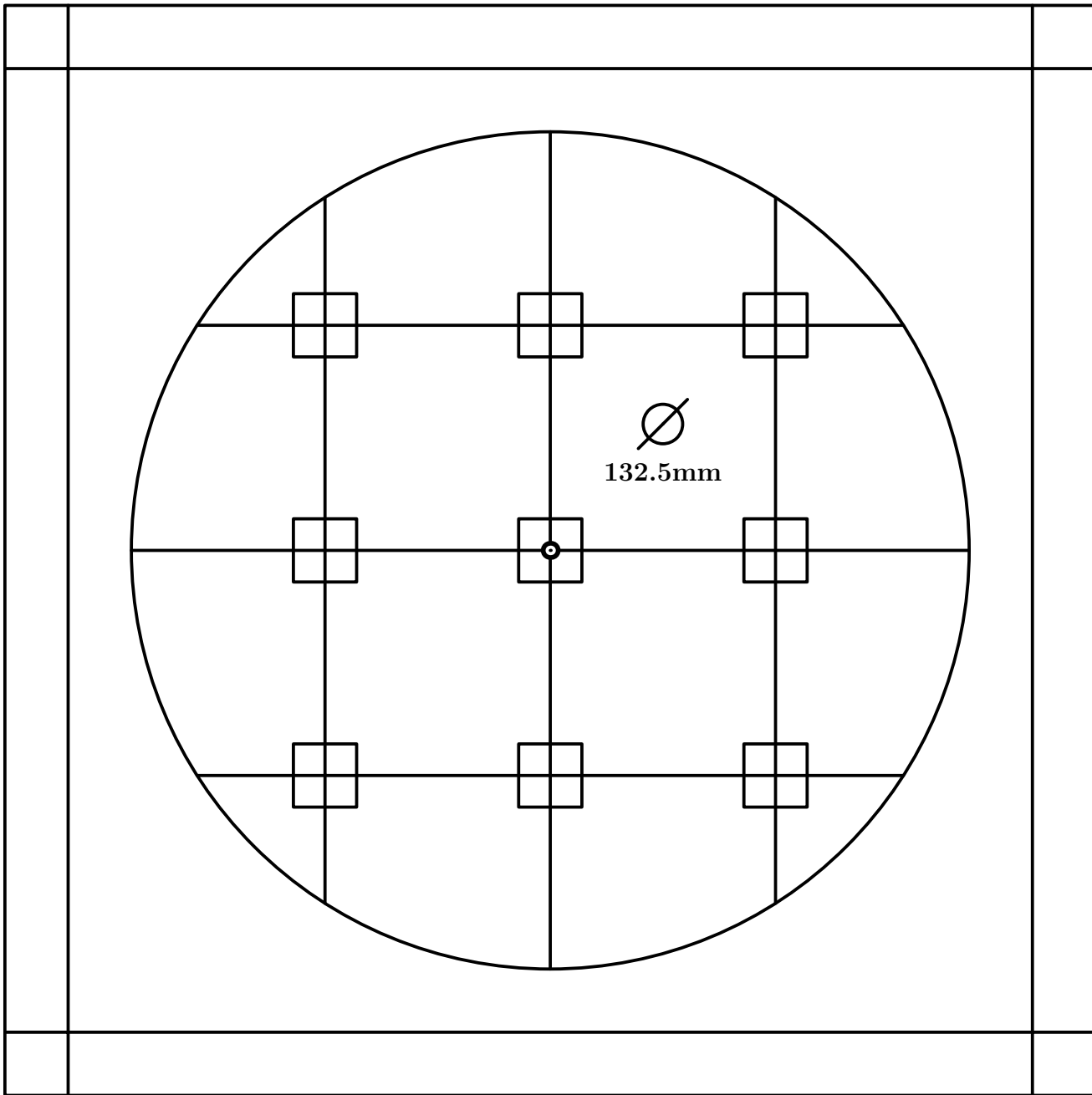

Fig. 131

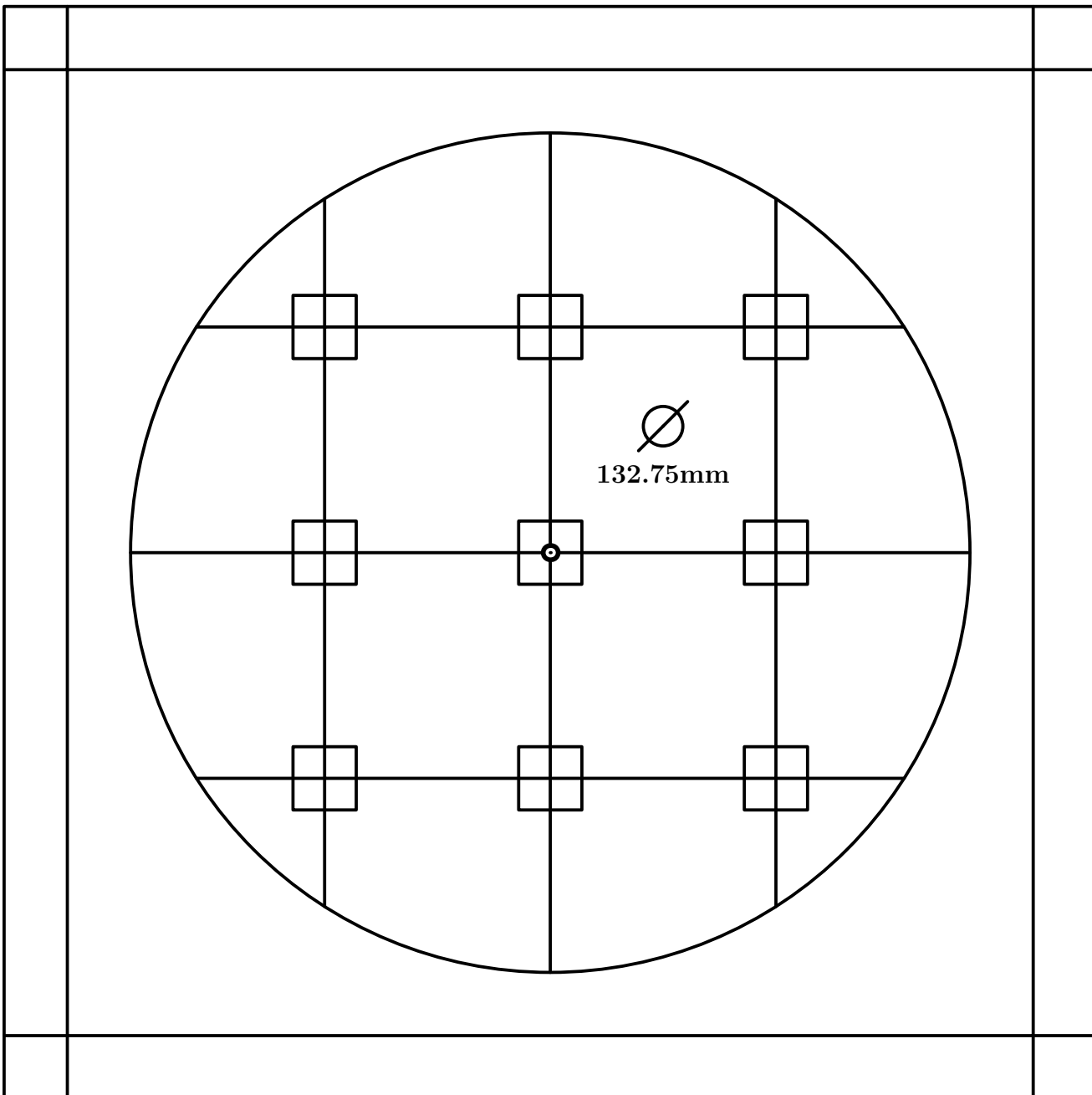

Fig. 132

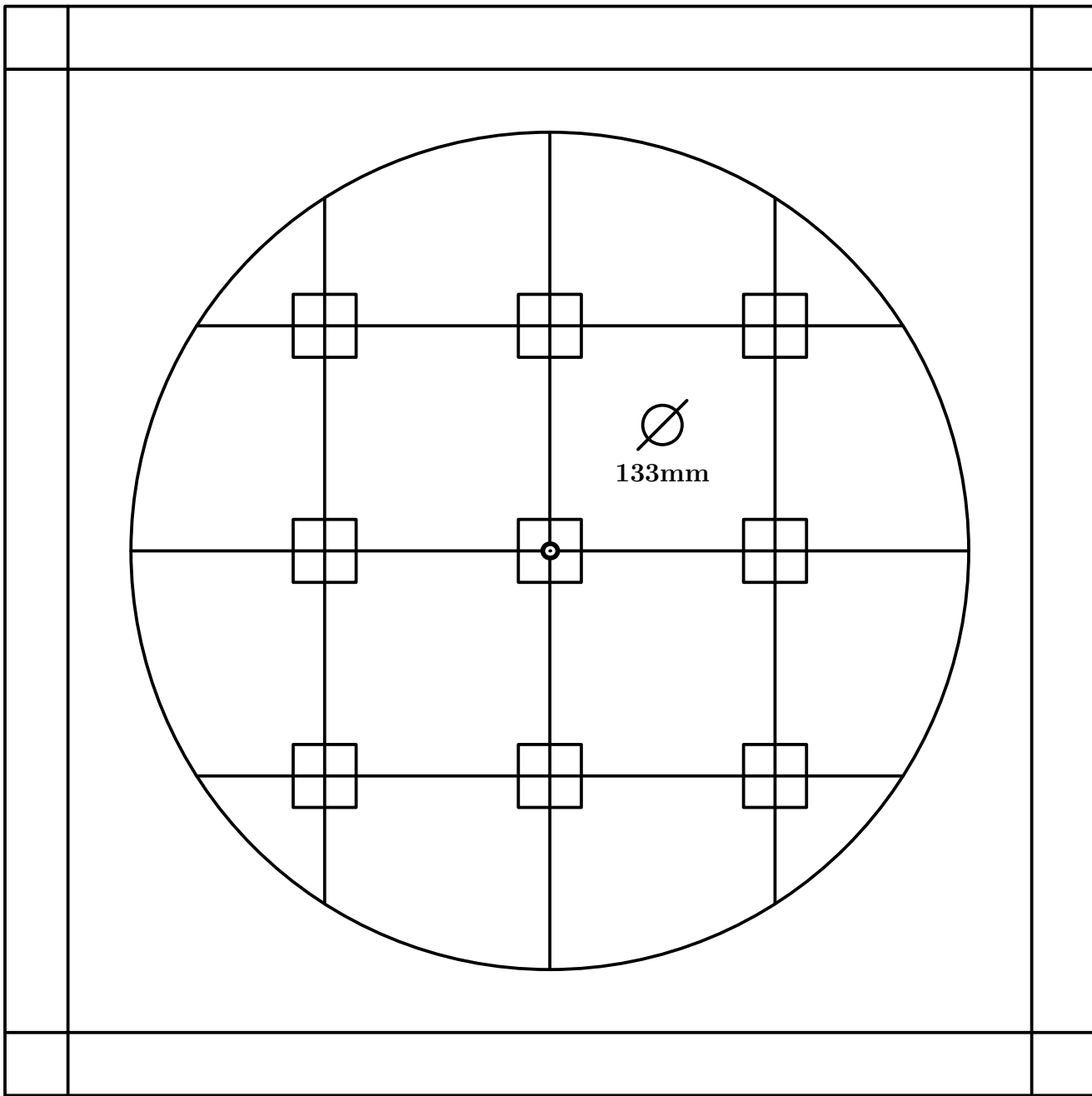

Fig. 133

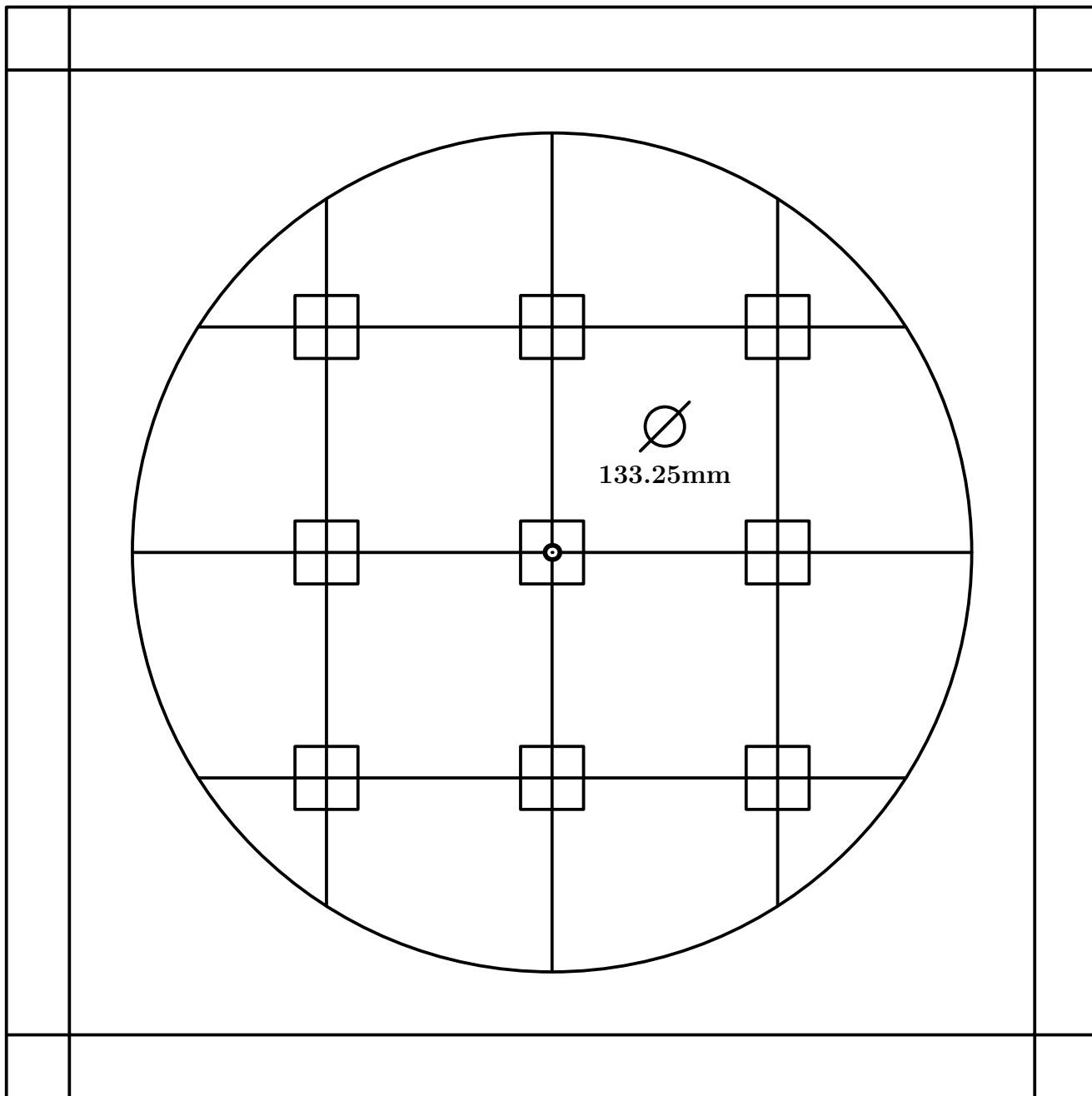

Fig. 134

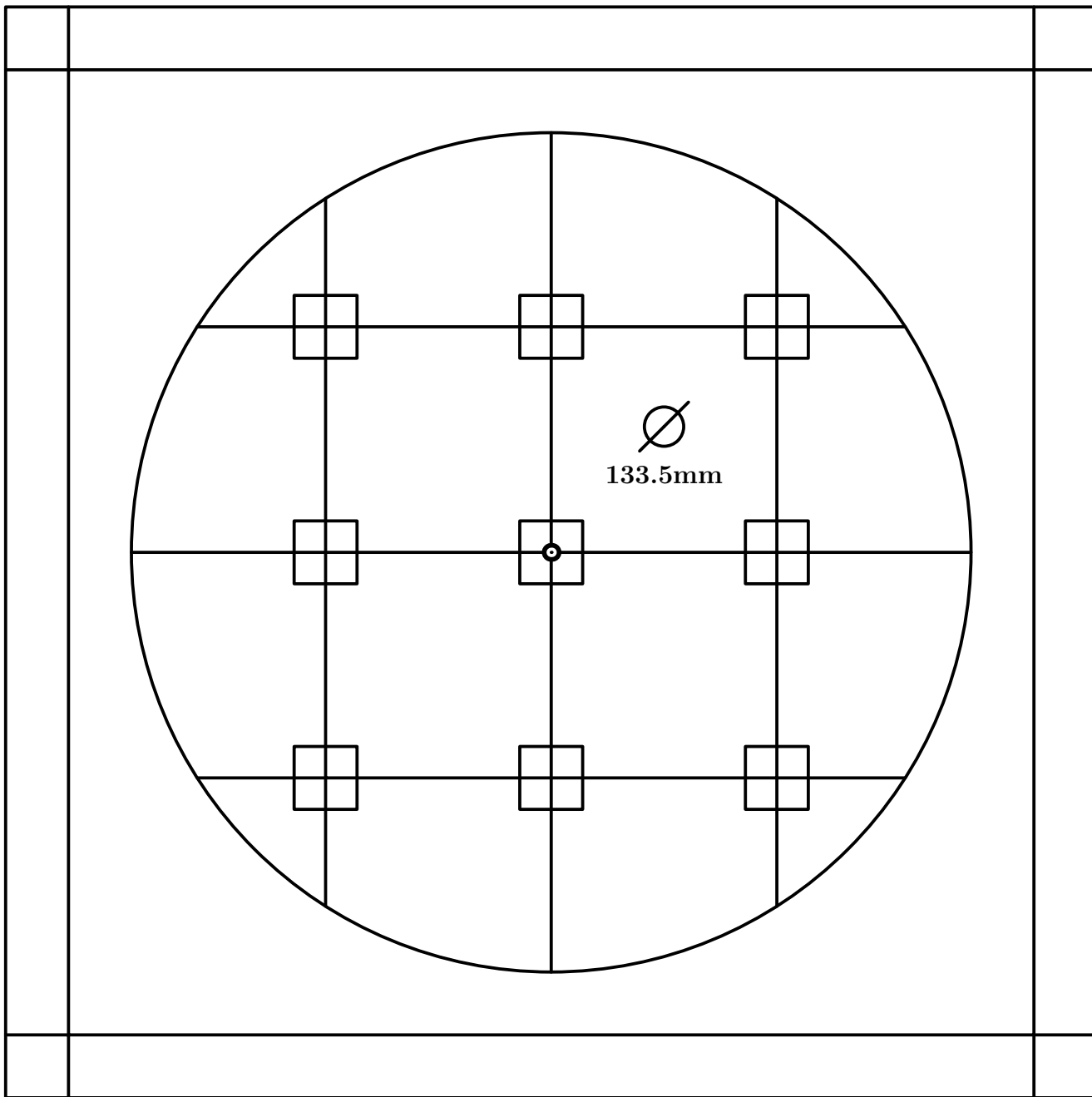

Fig. 135

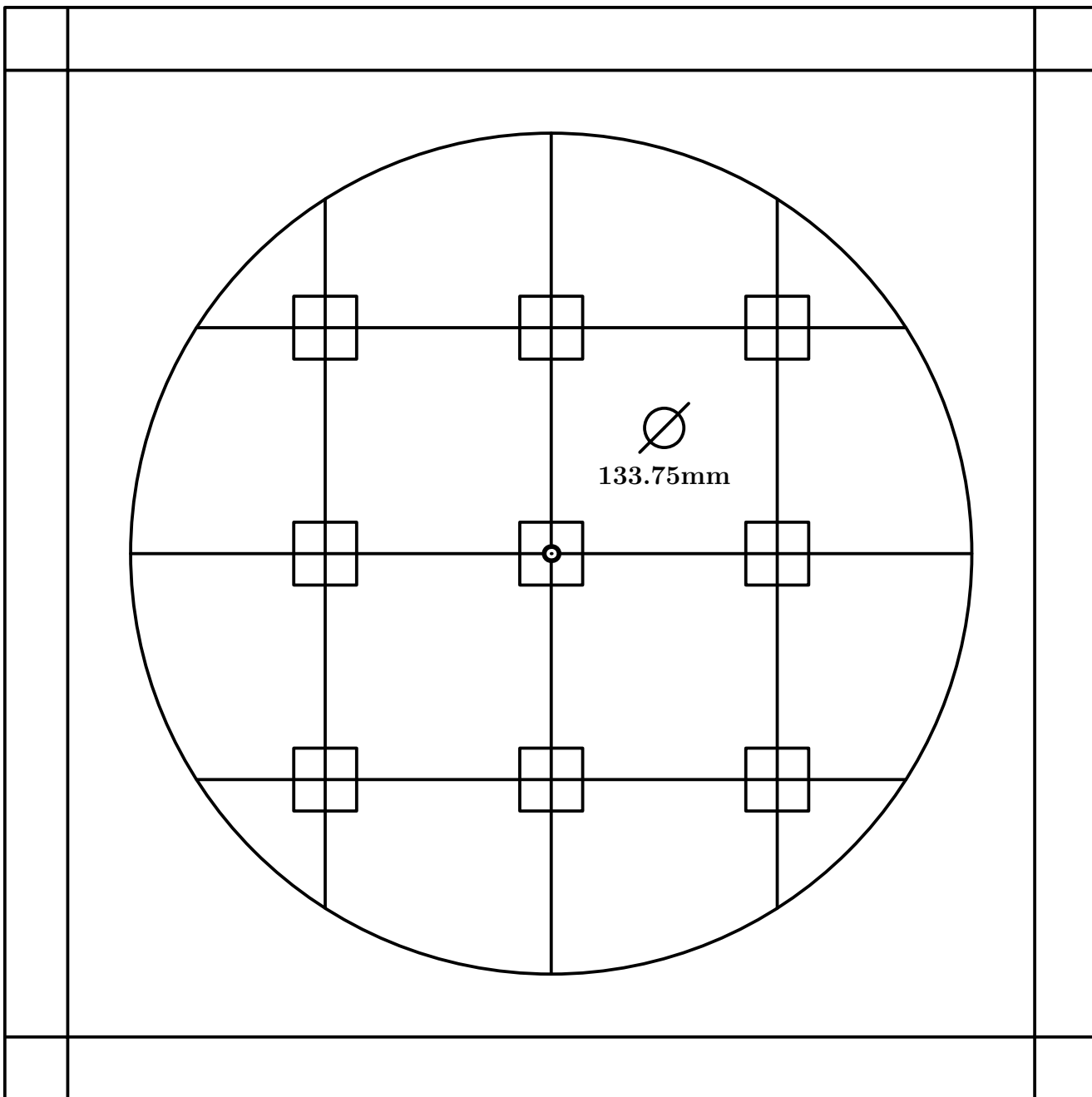

Fig. 136

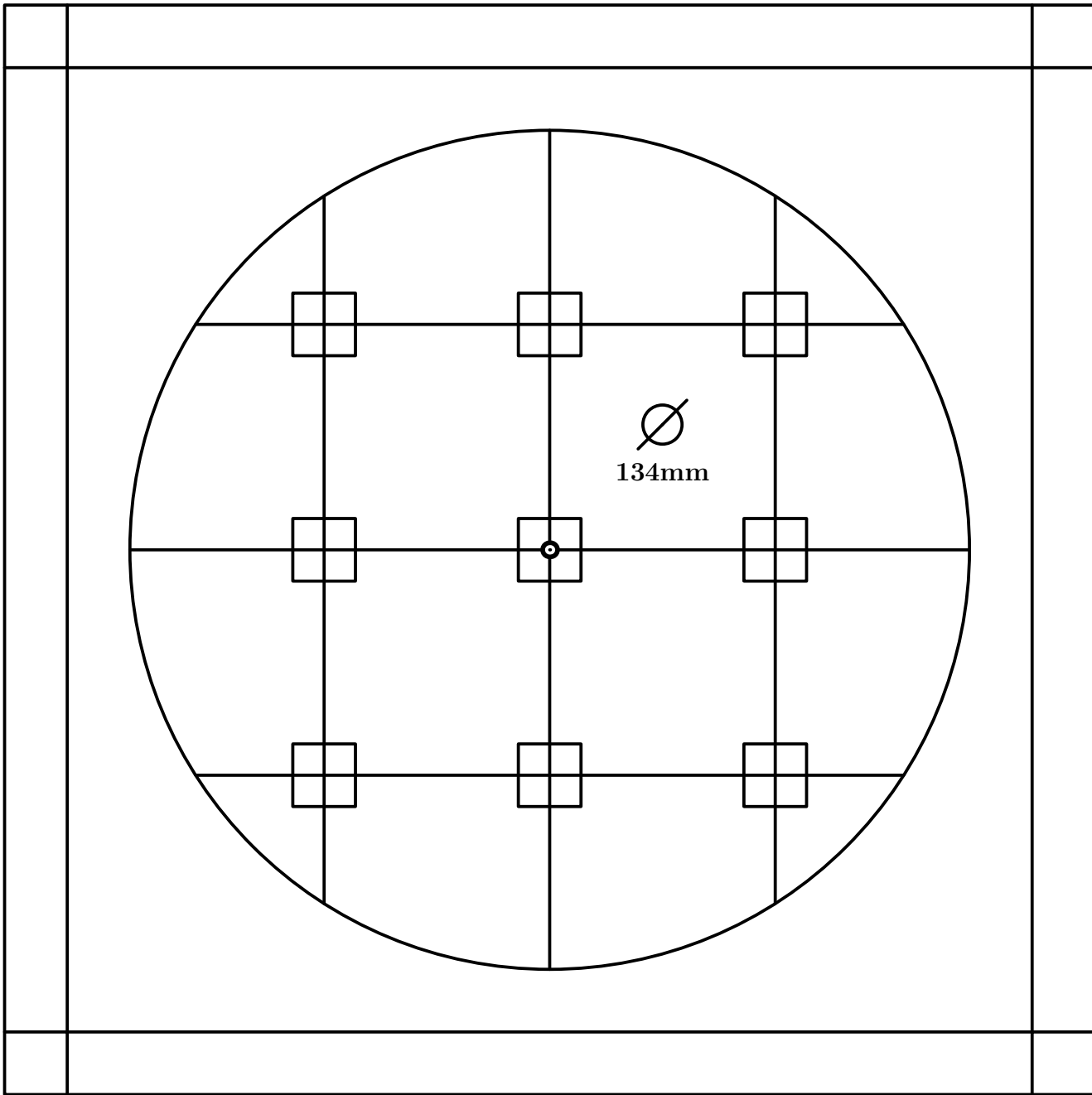

Fig. 137

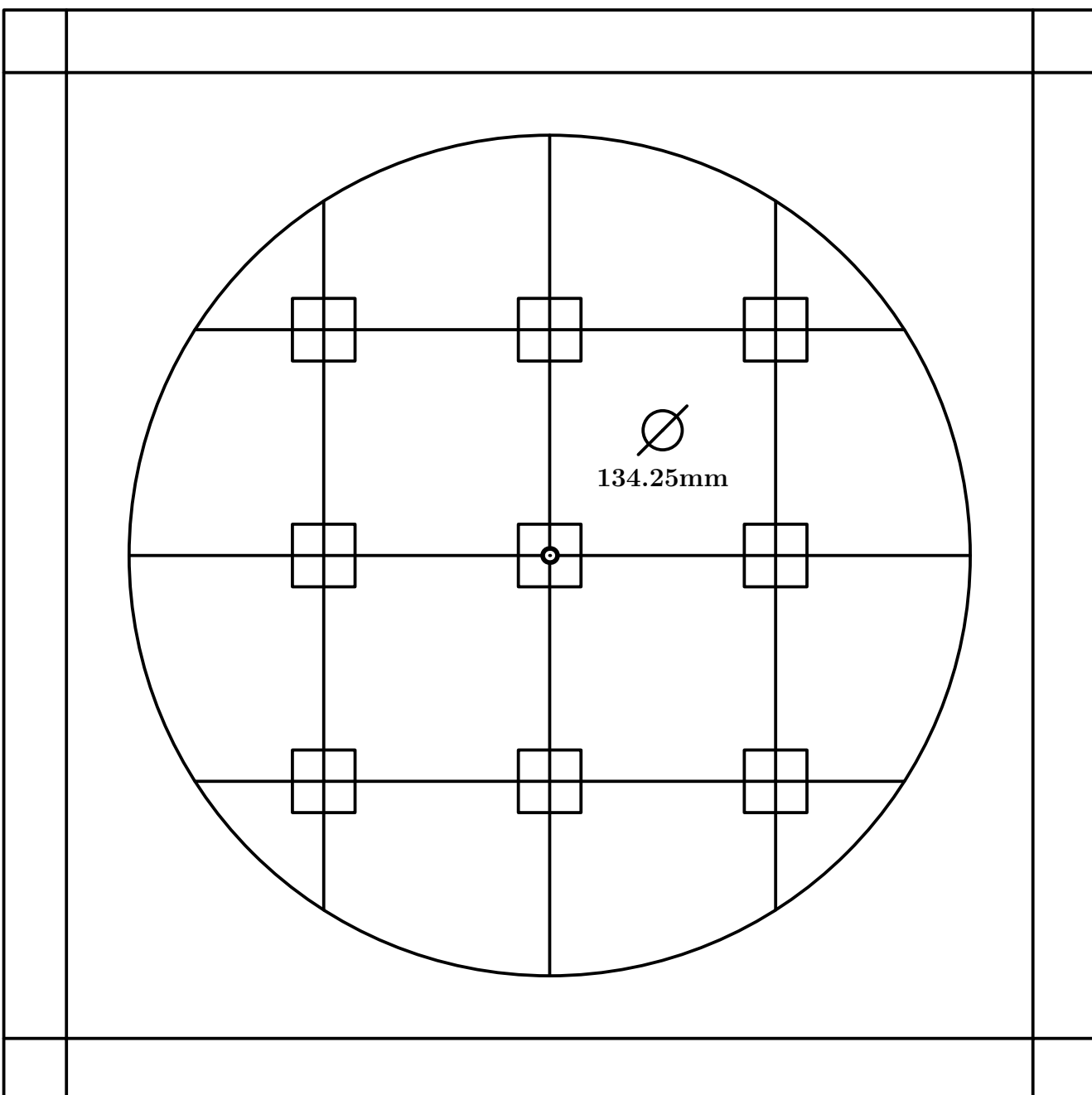

Fig. 138

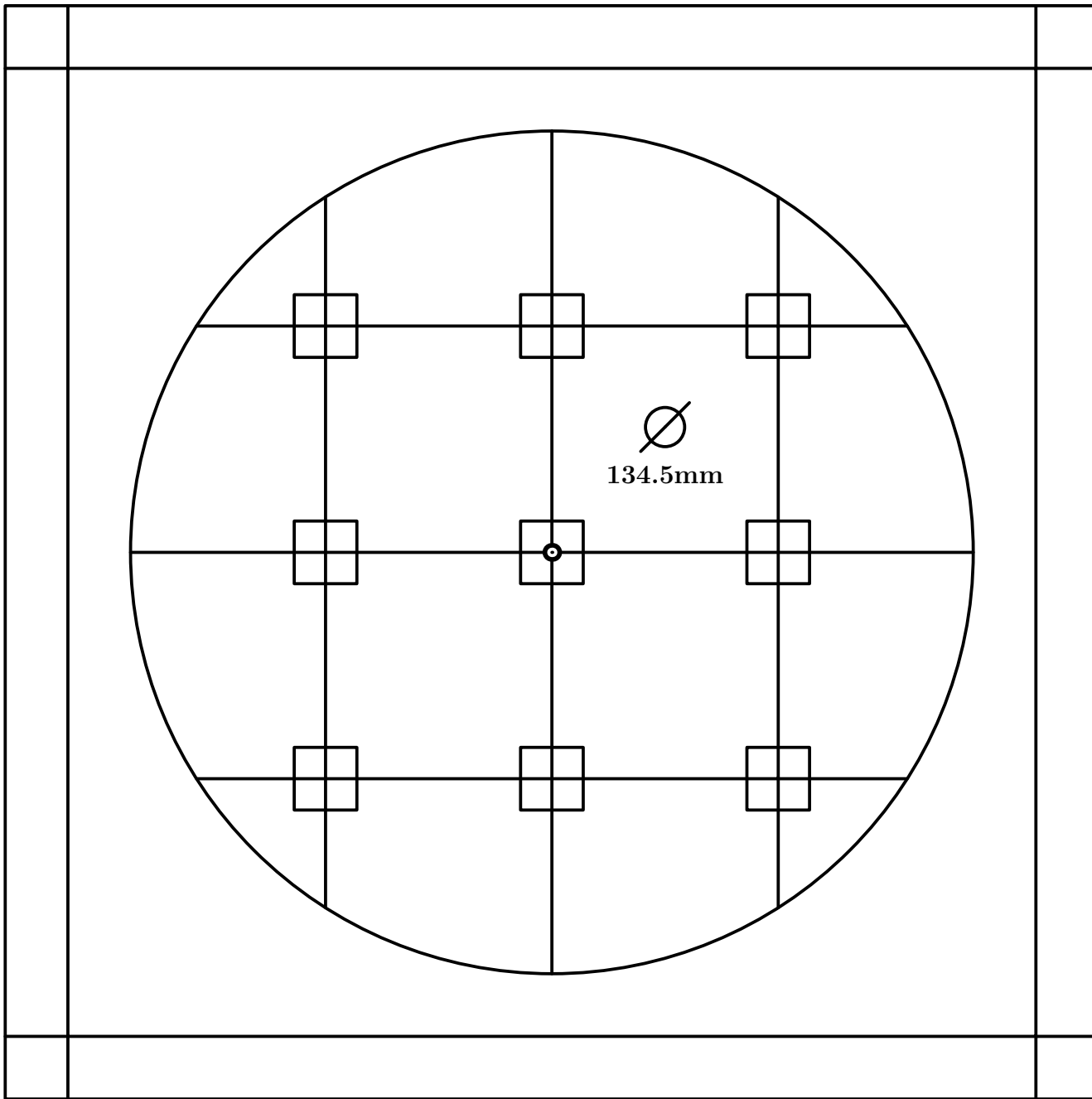

Fig. 139

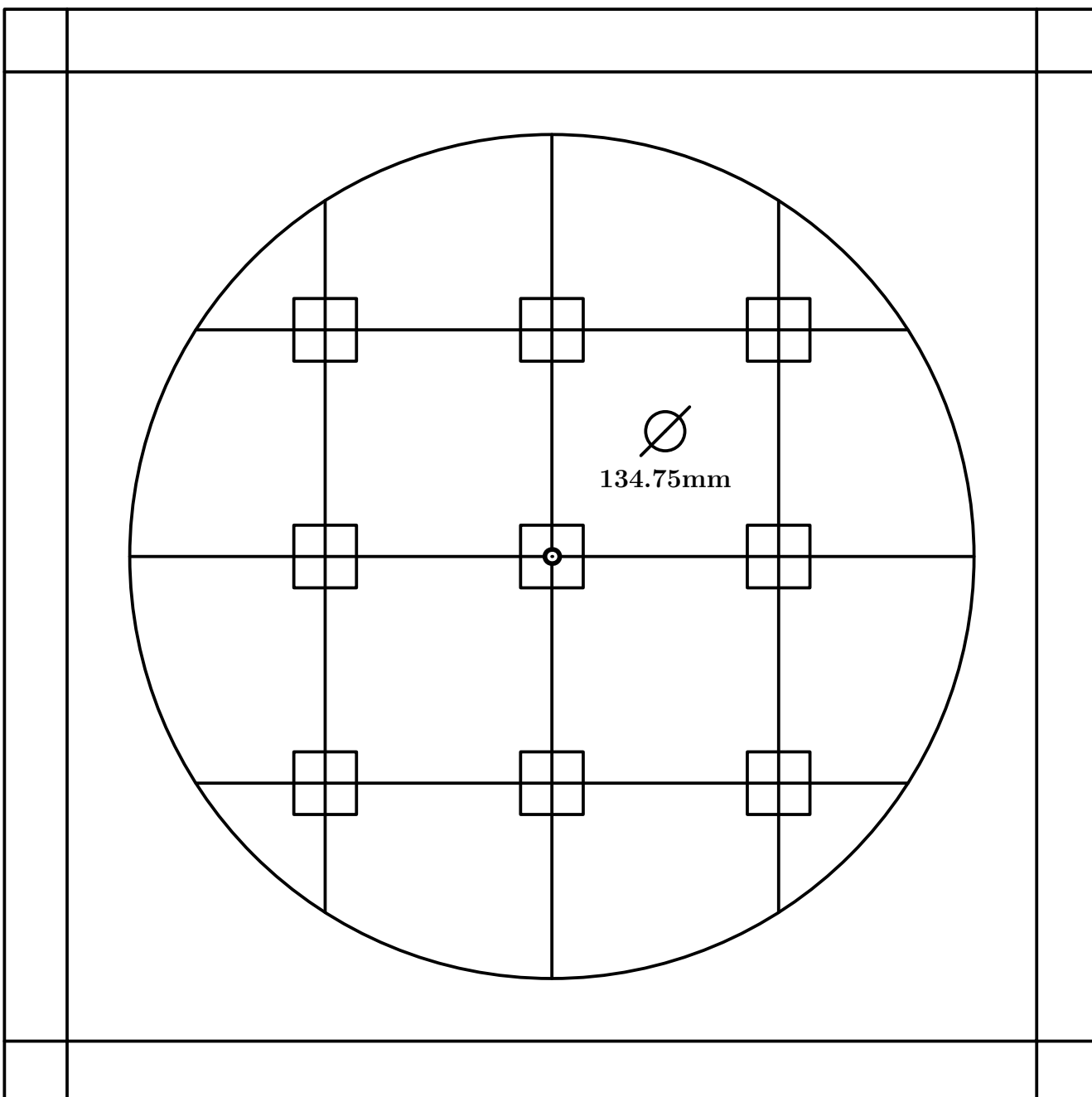

Fig. 140

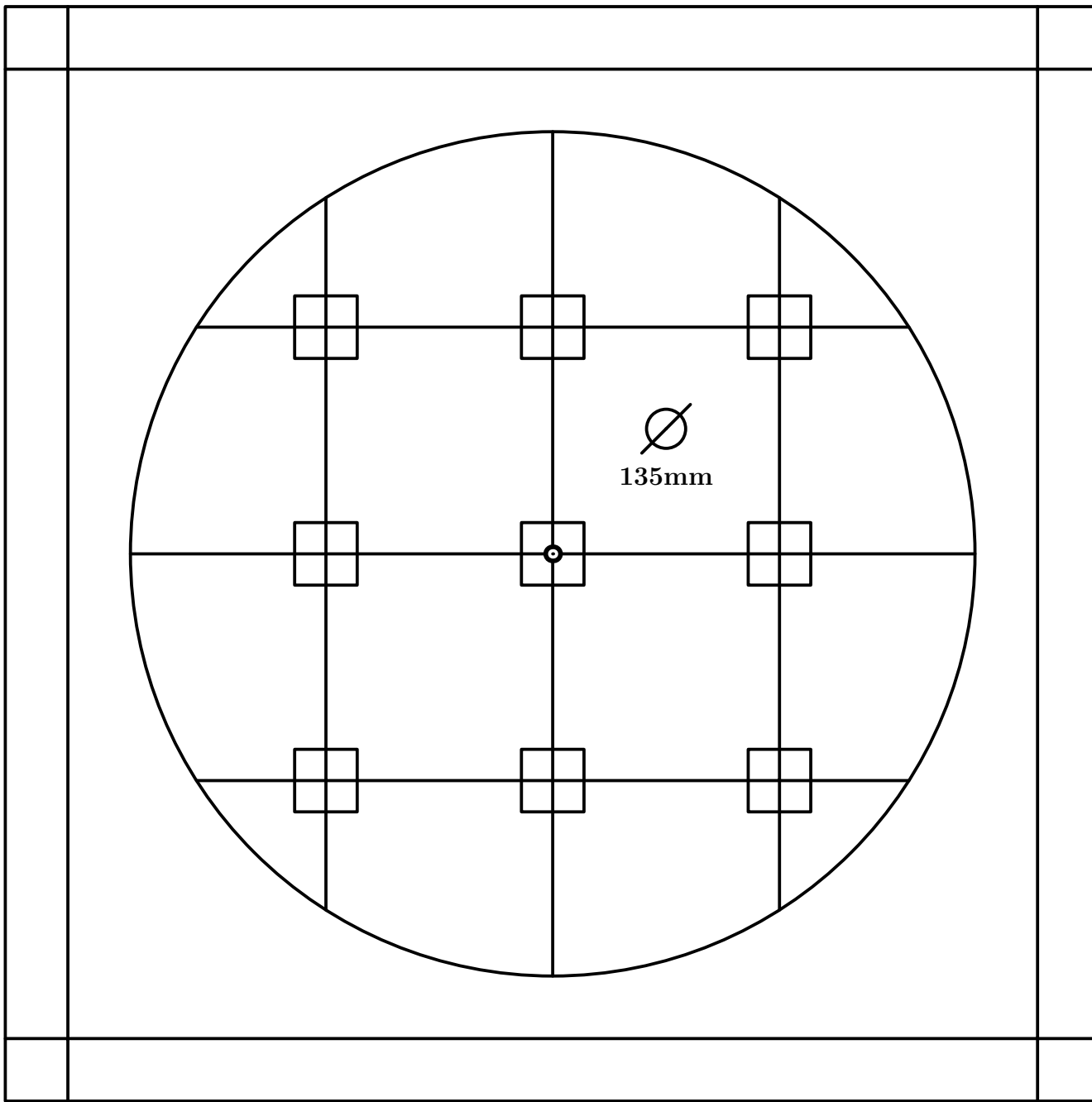

Fig. 141

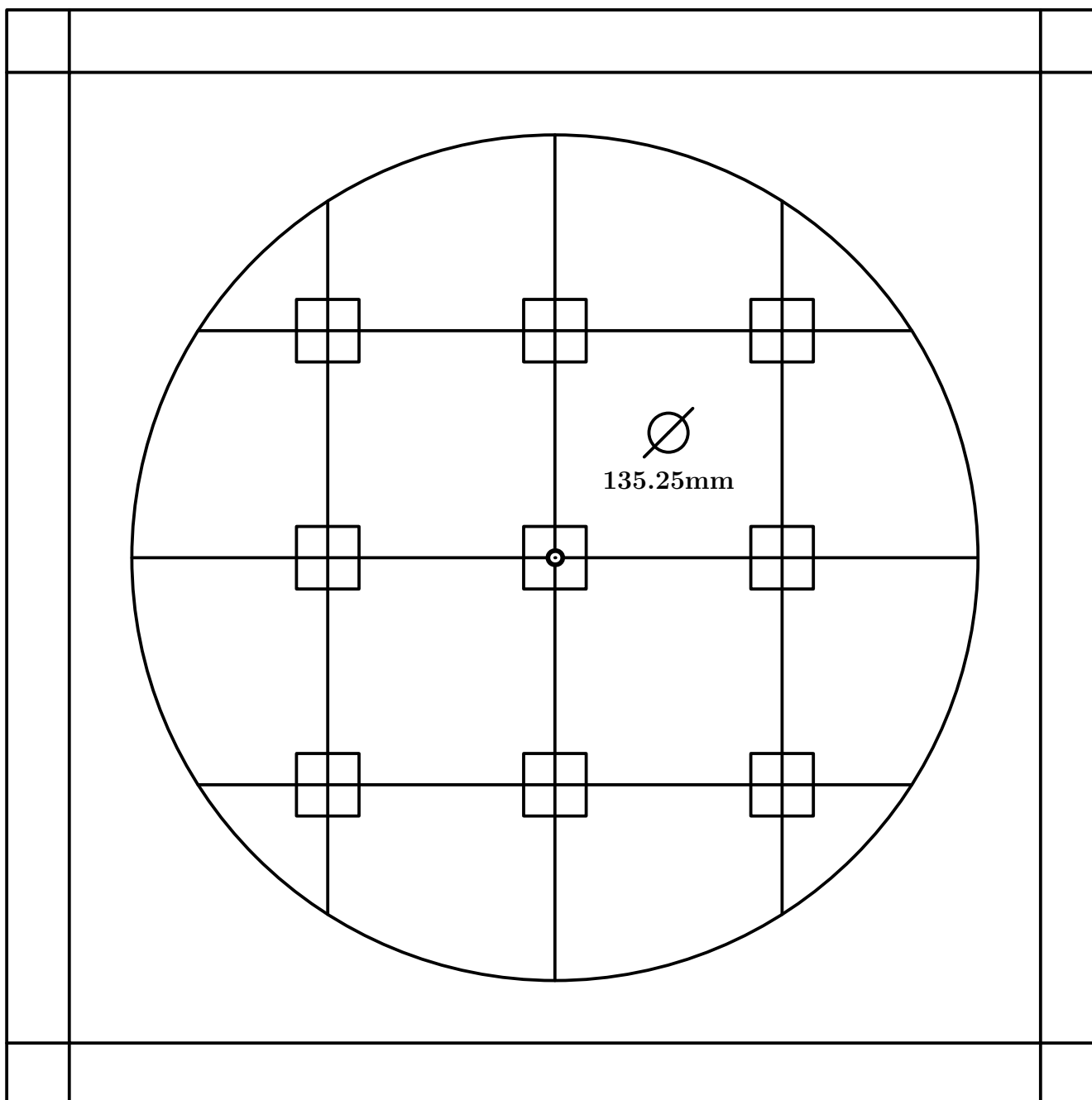

Fig. 142

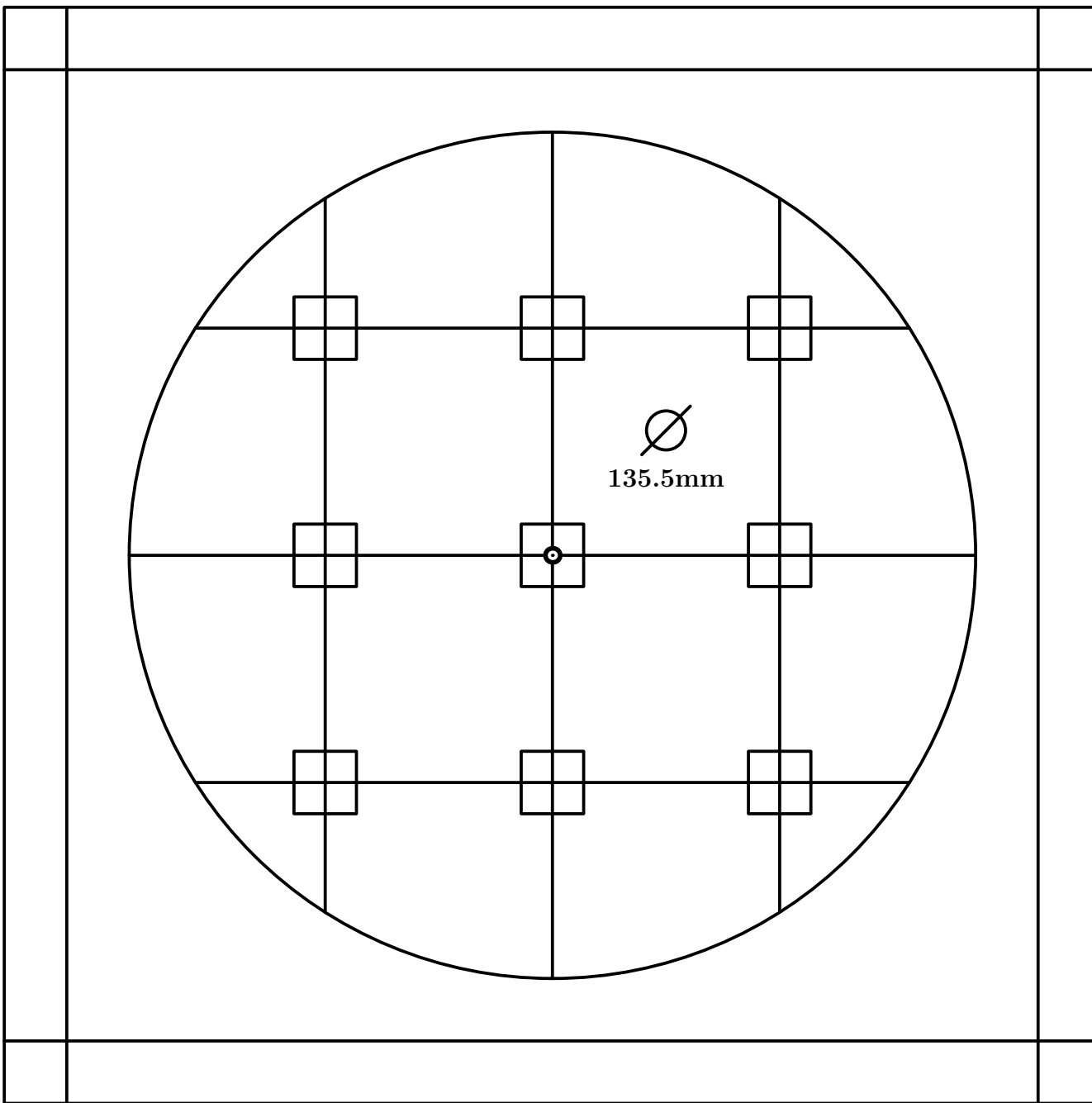

Fig. 143

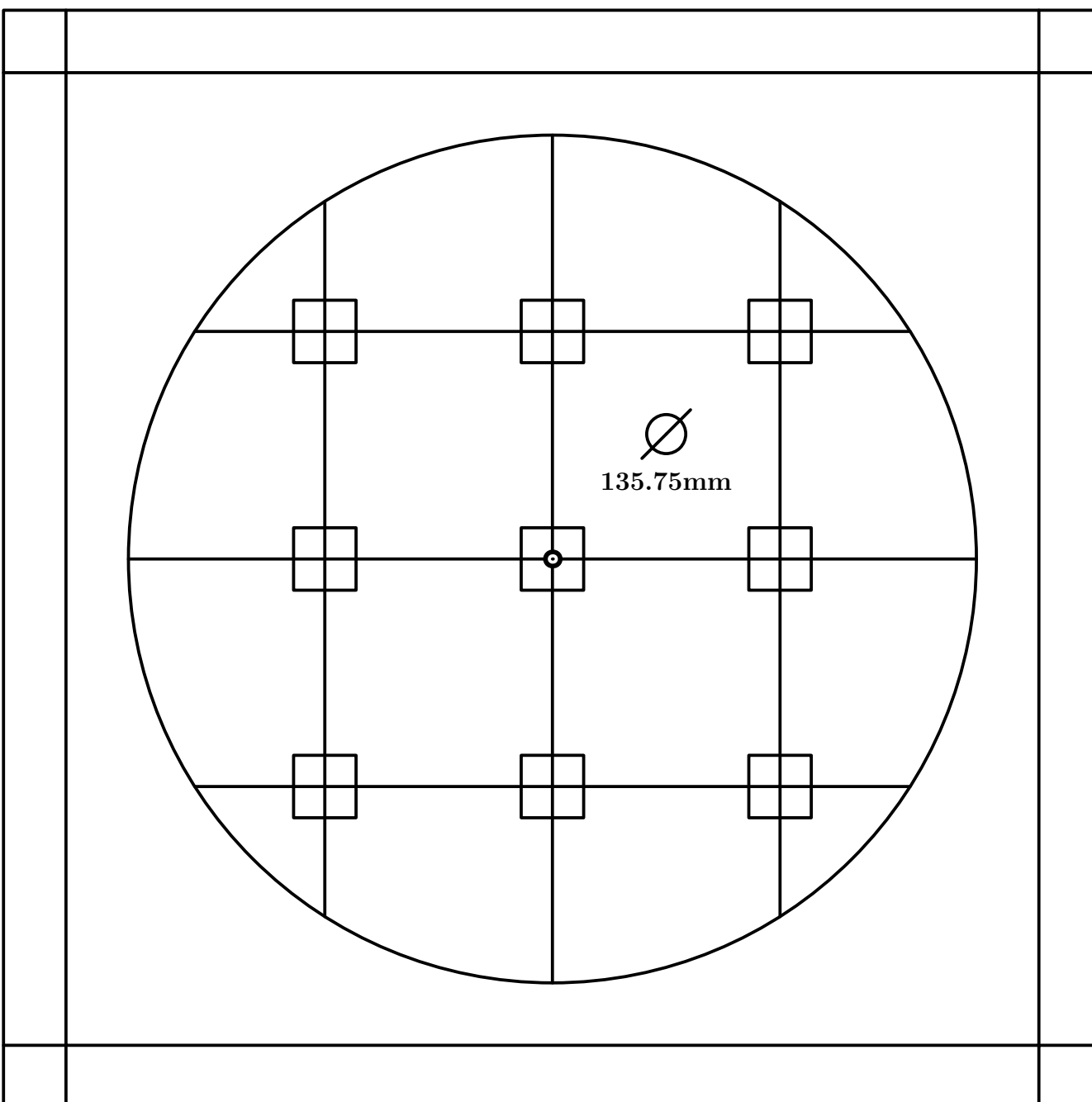

Fig. 144

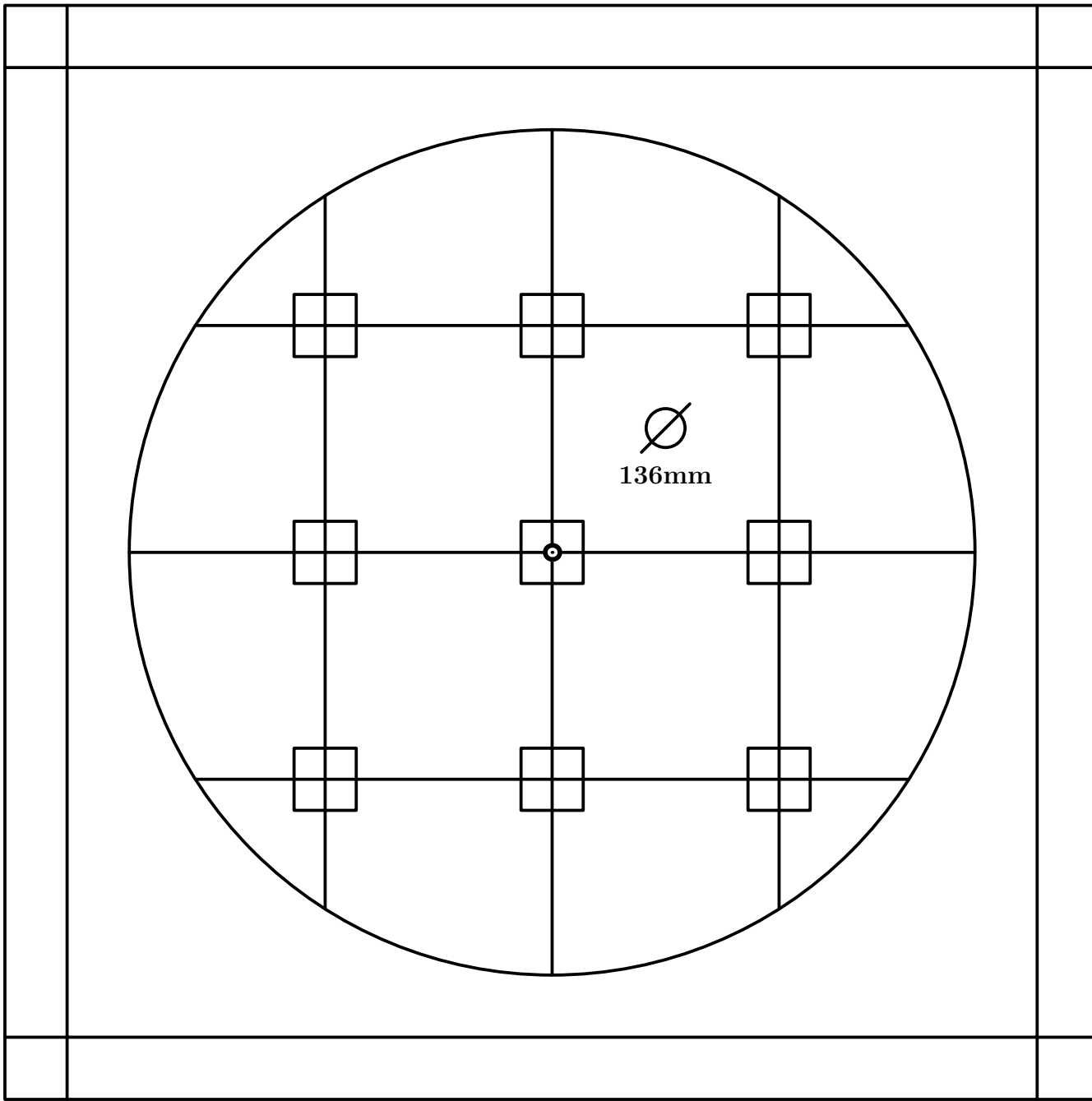

Fig. 145

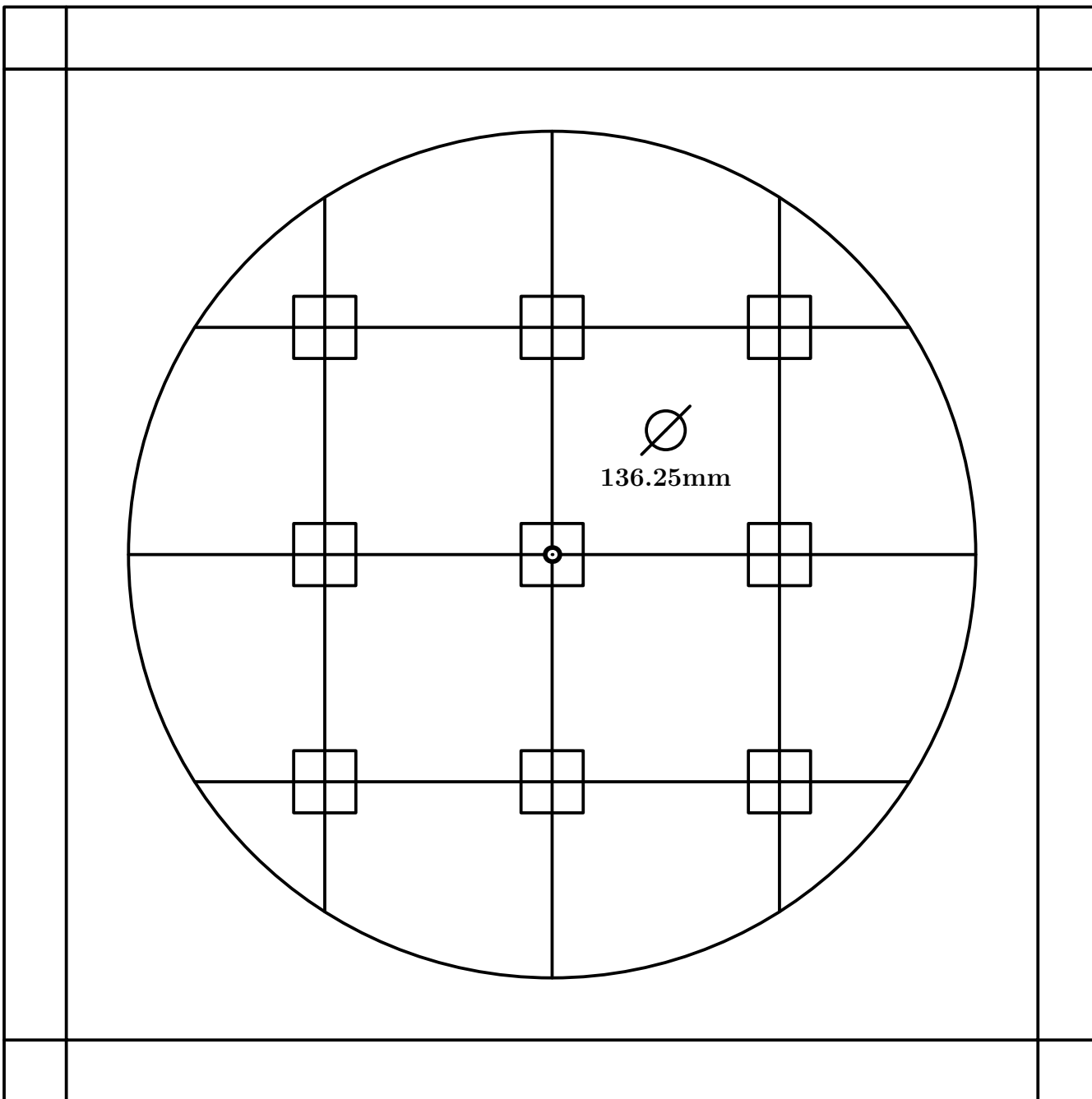

Fig. 146

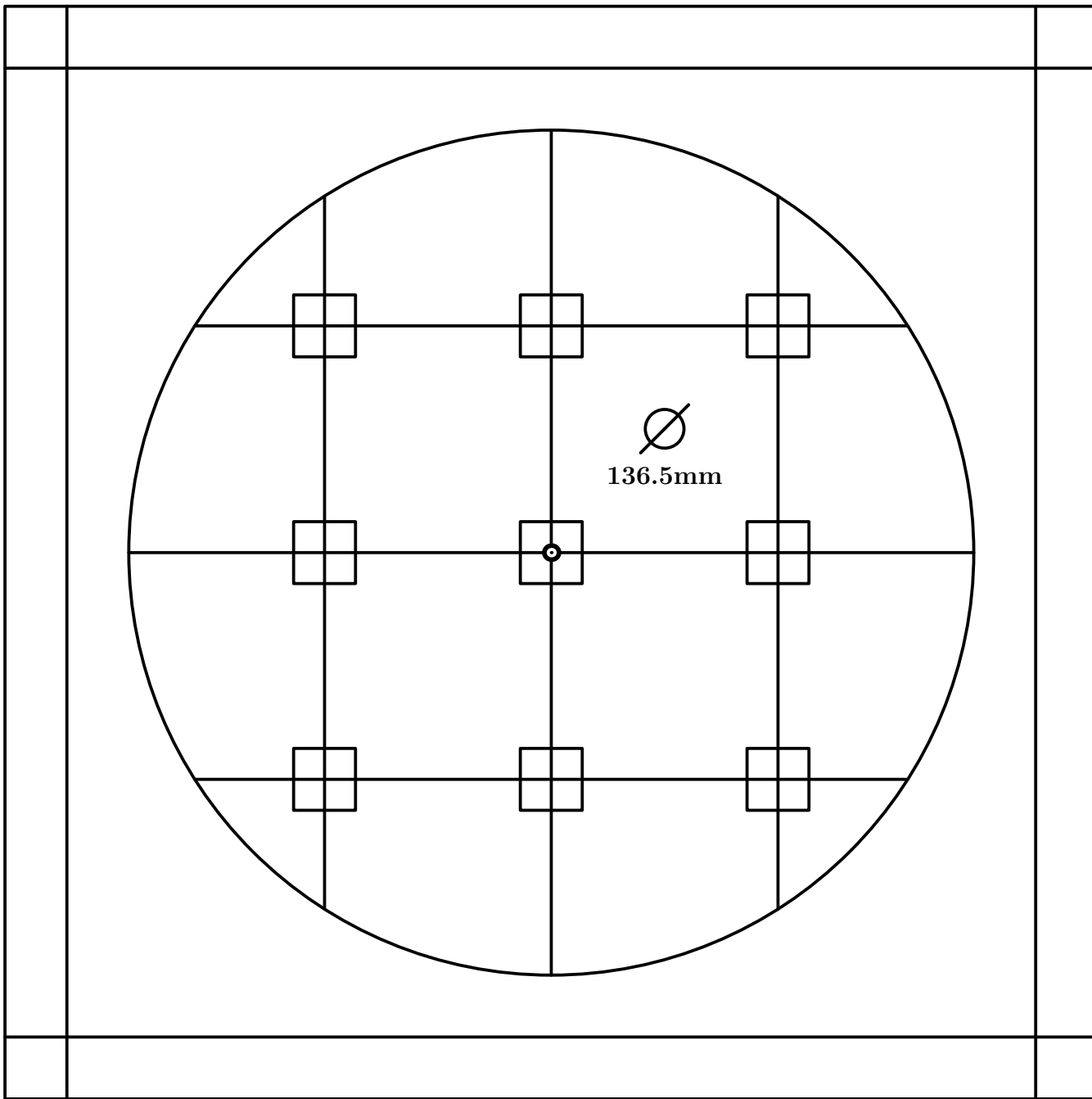

Fig. 147

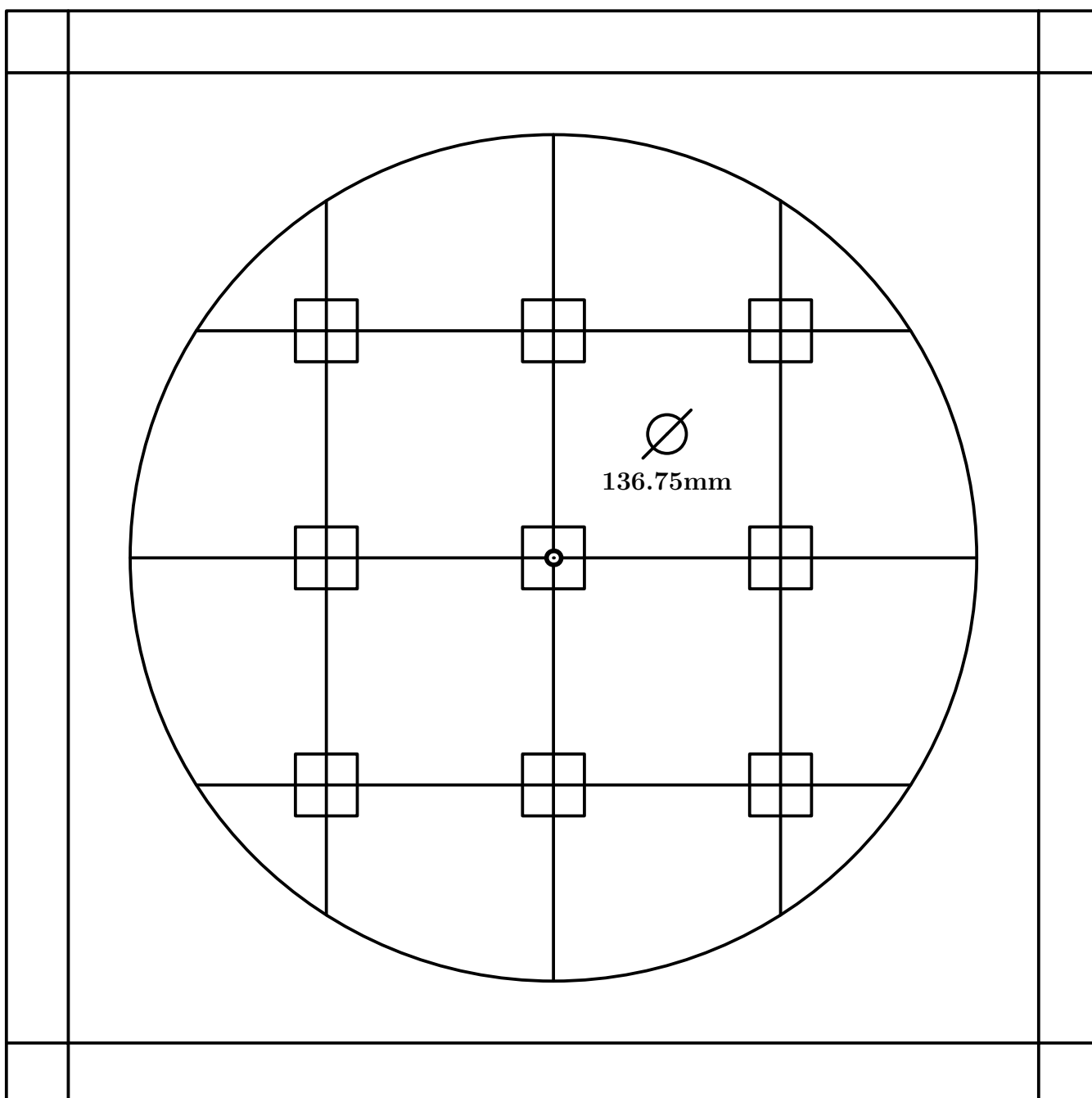

Fig. 148

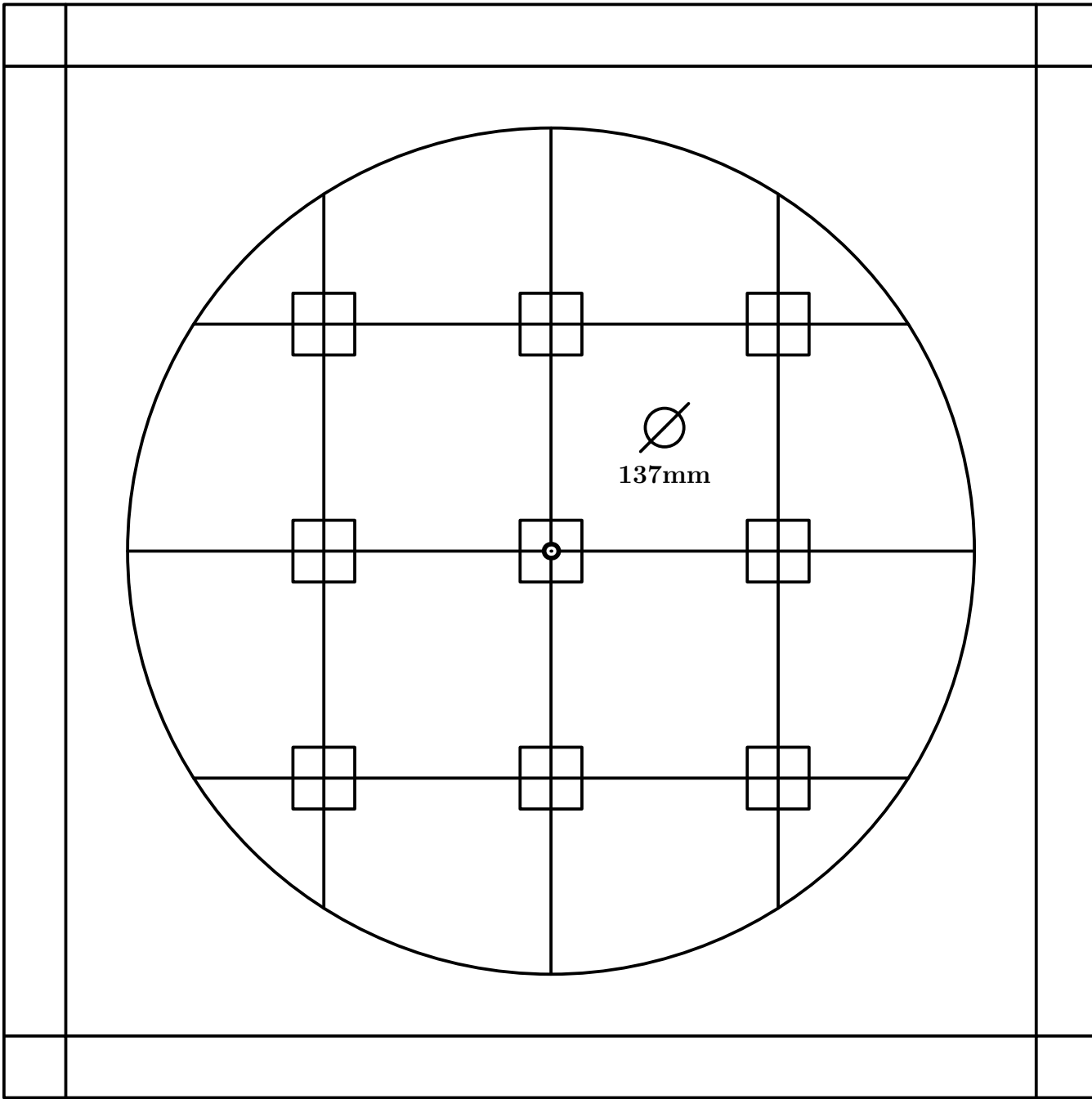

Fig. 149

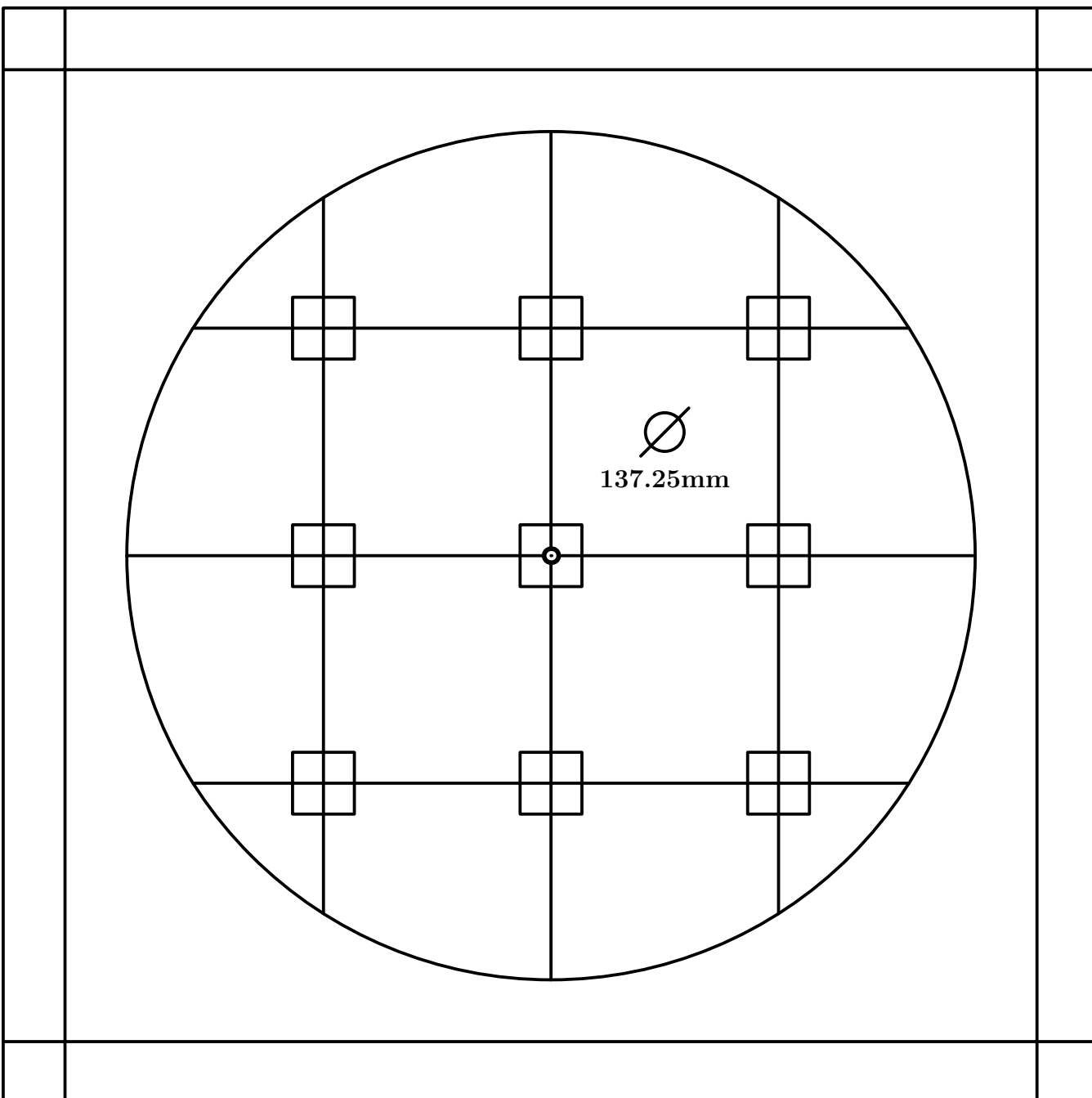

Fig. 150

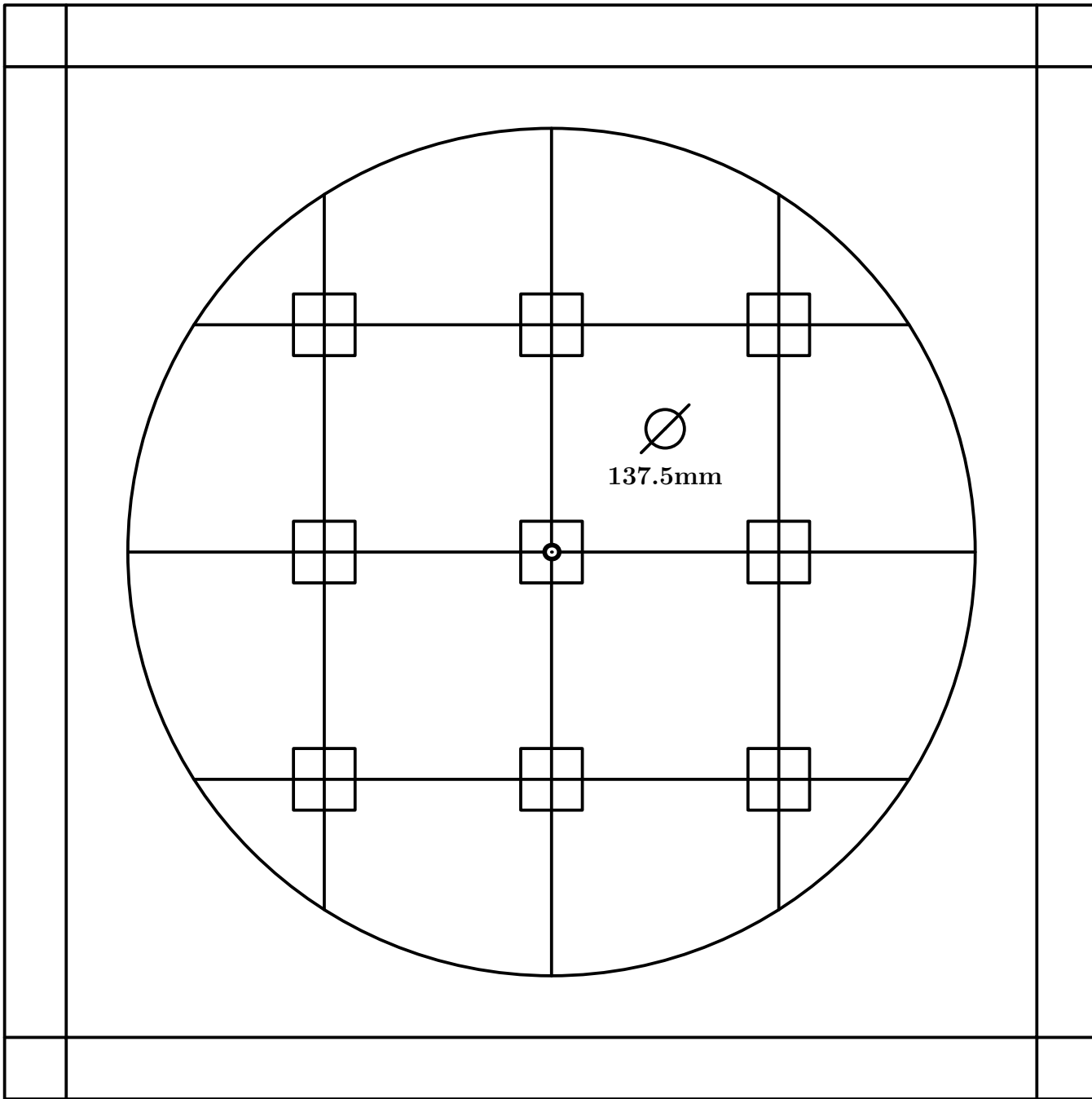

Fig. 151

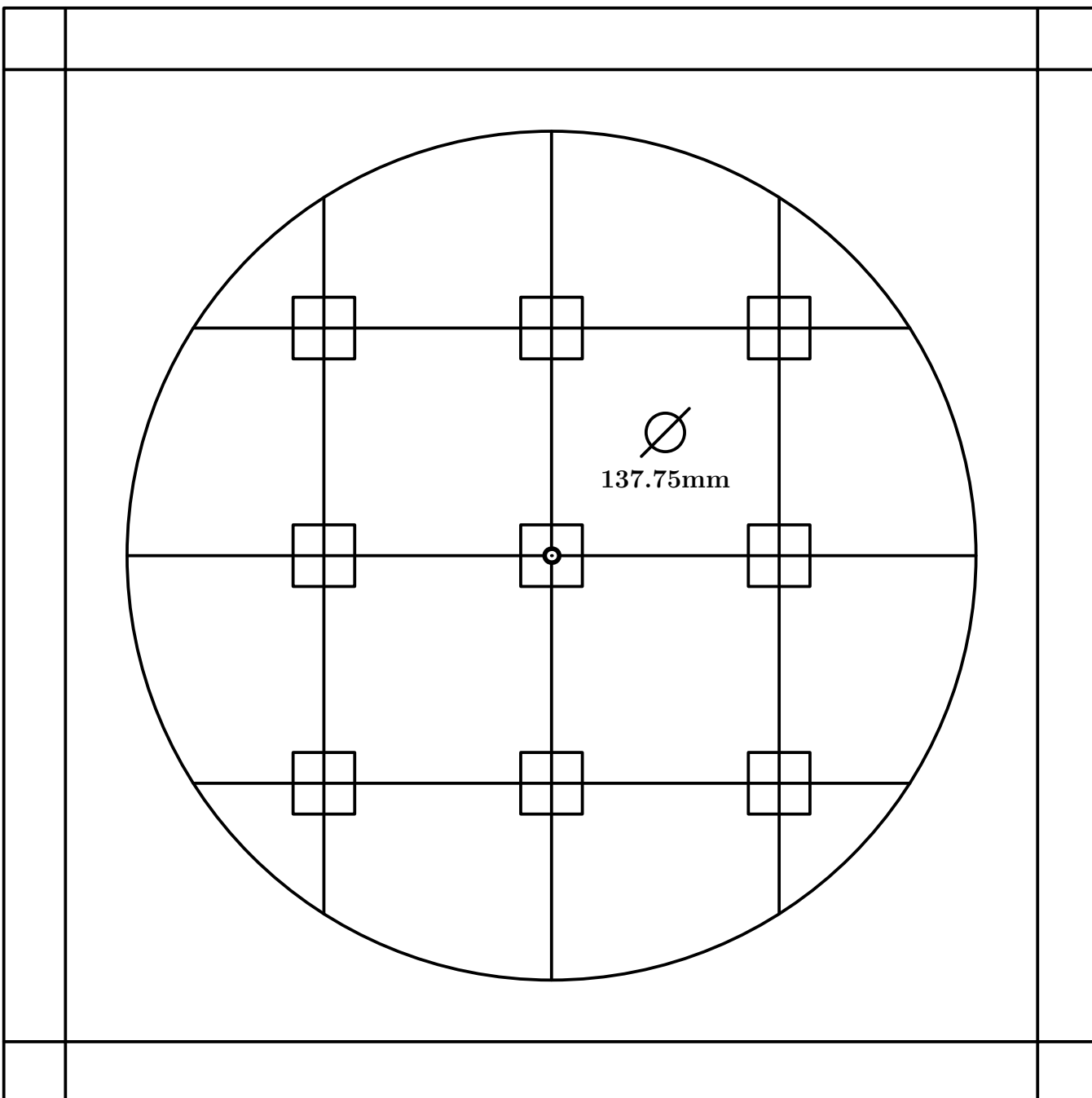

Fig. 152

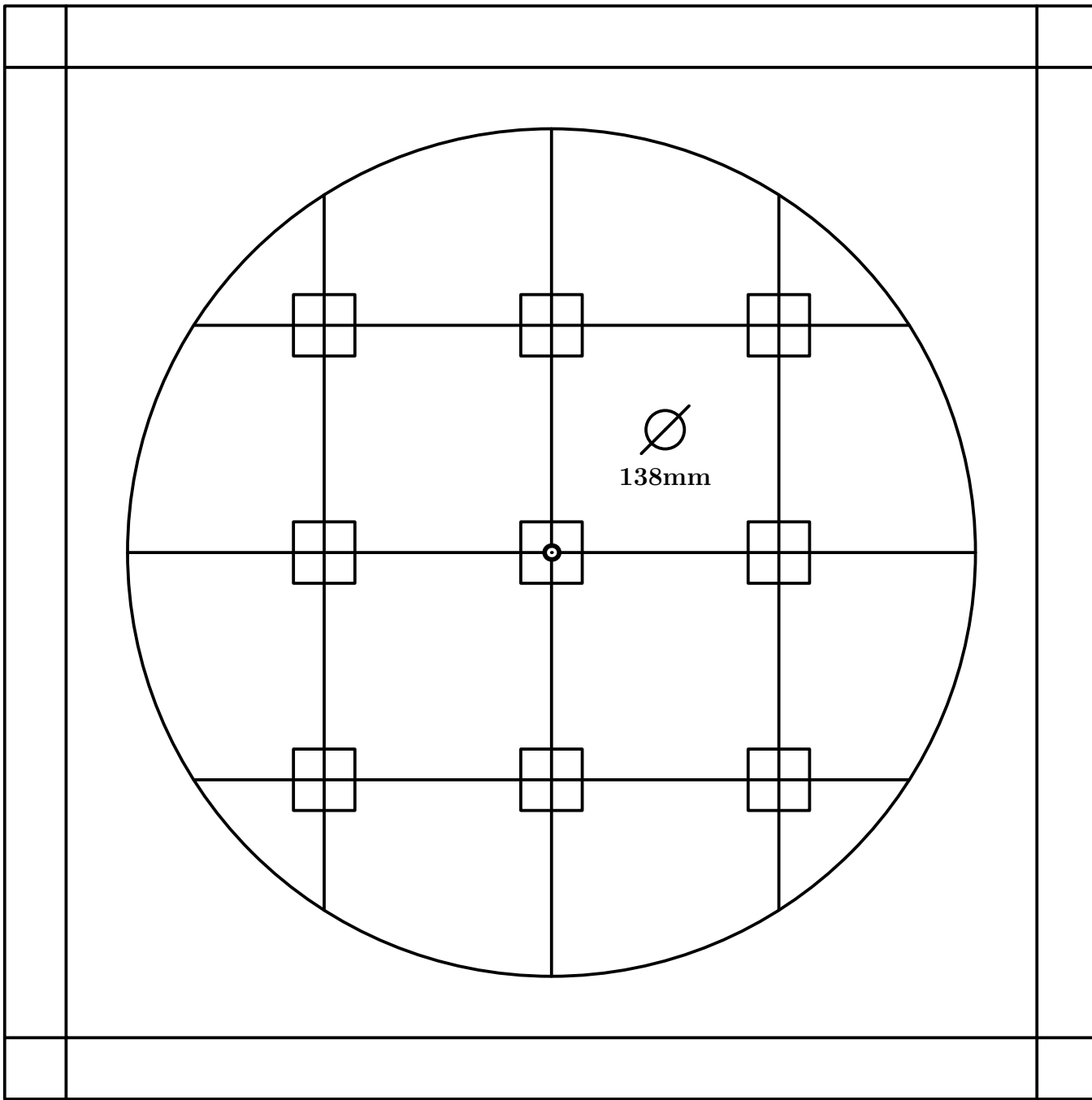

Fig. 153

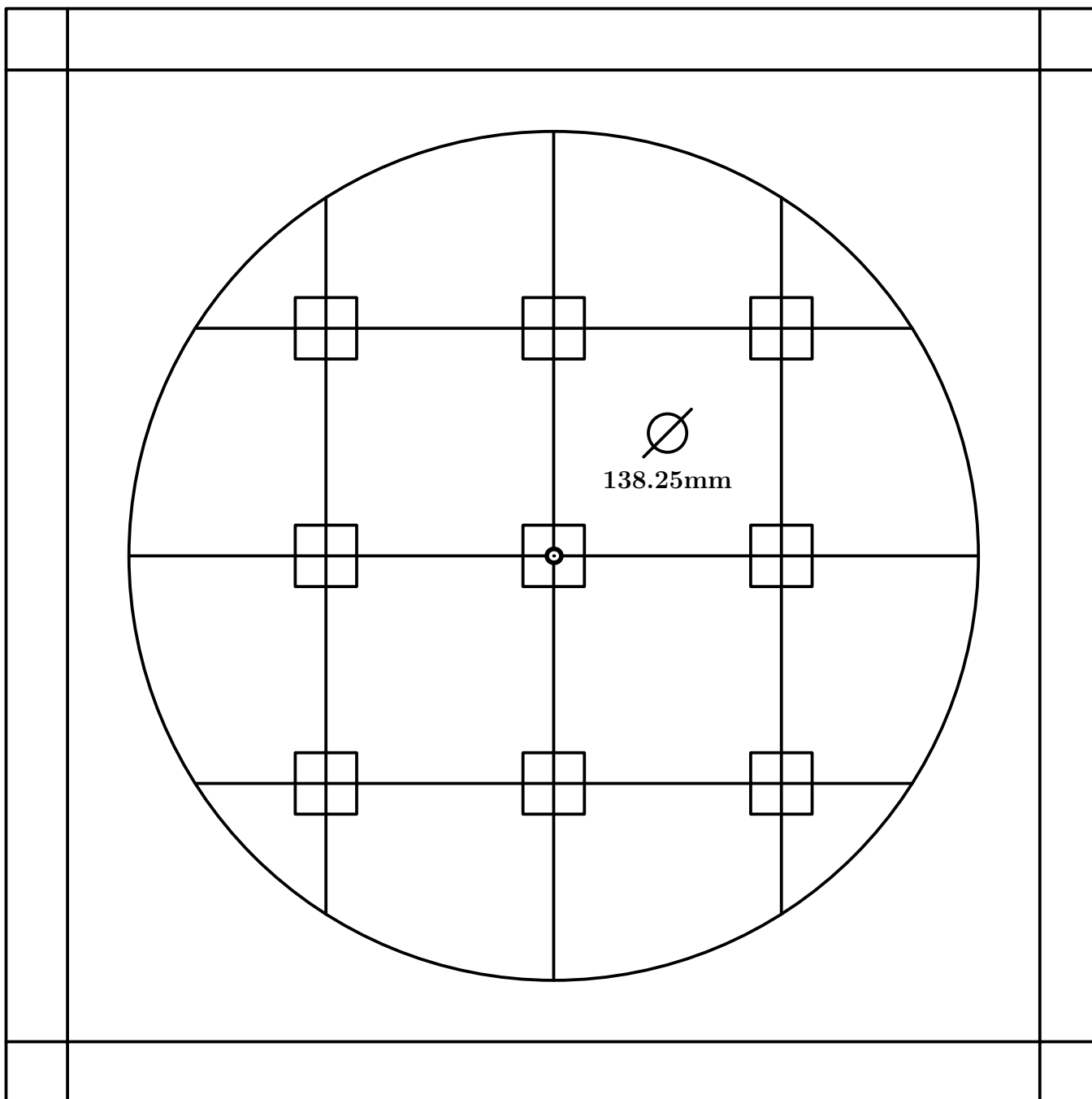

Fig. 154

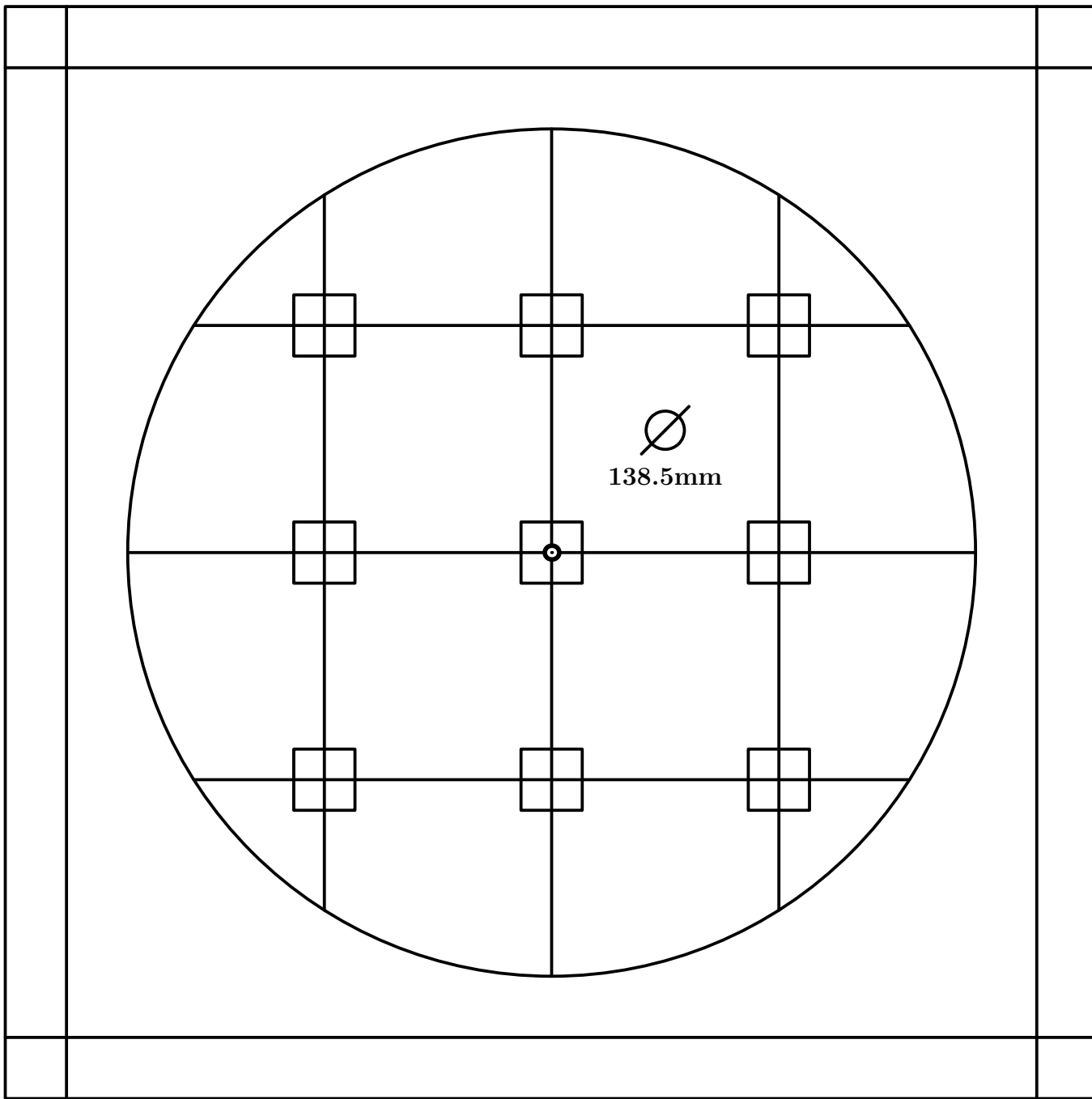

Fig. 155

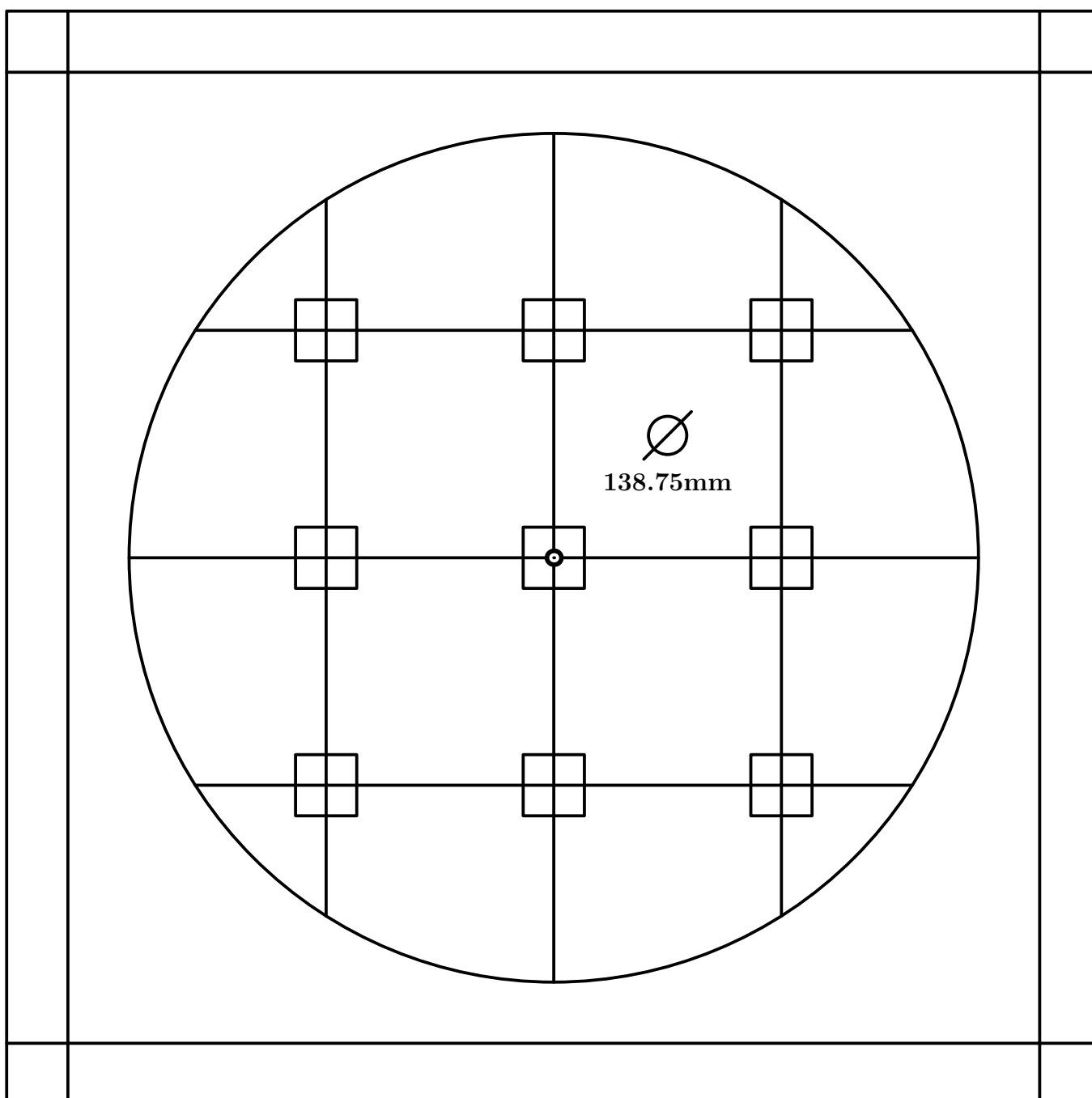

Fig. 156

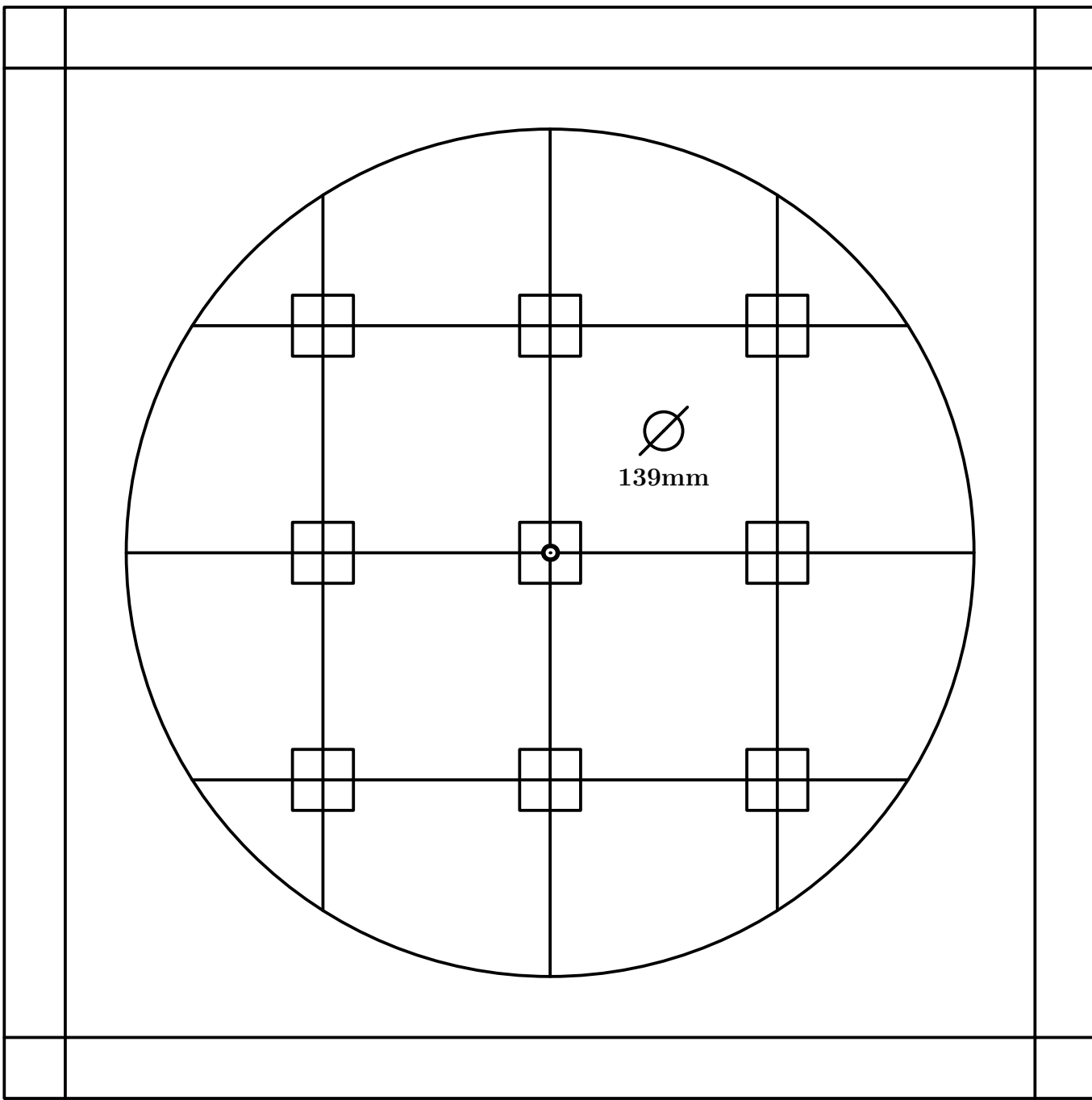

Fig. 157

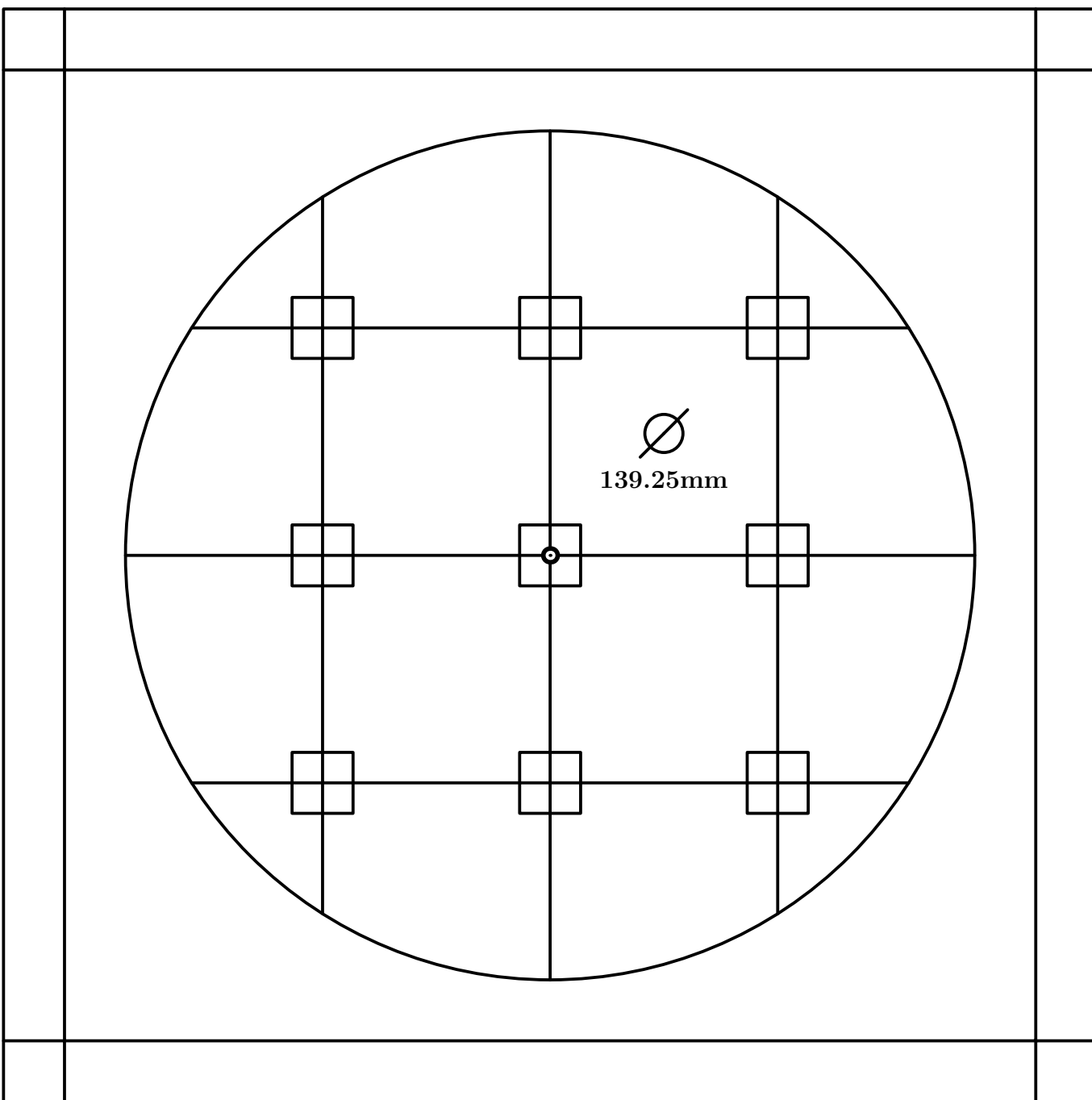

Fig. 158

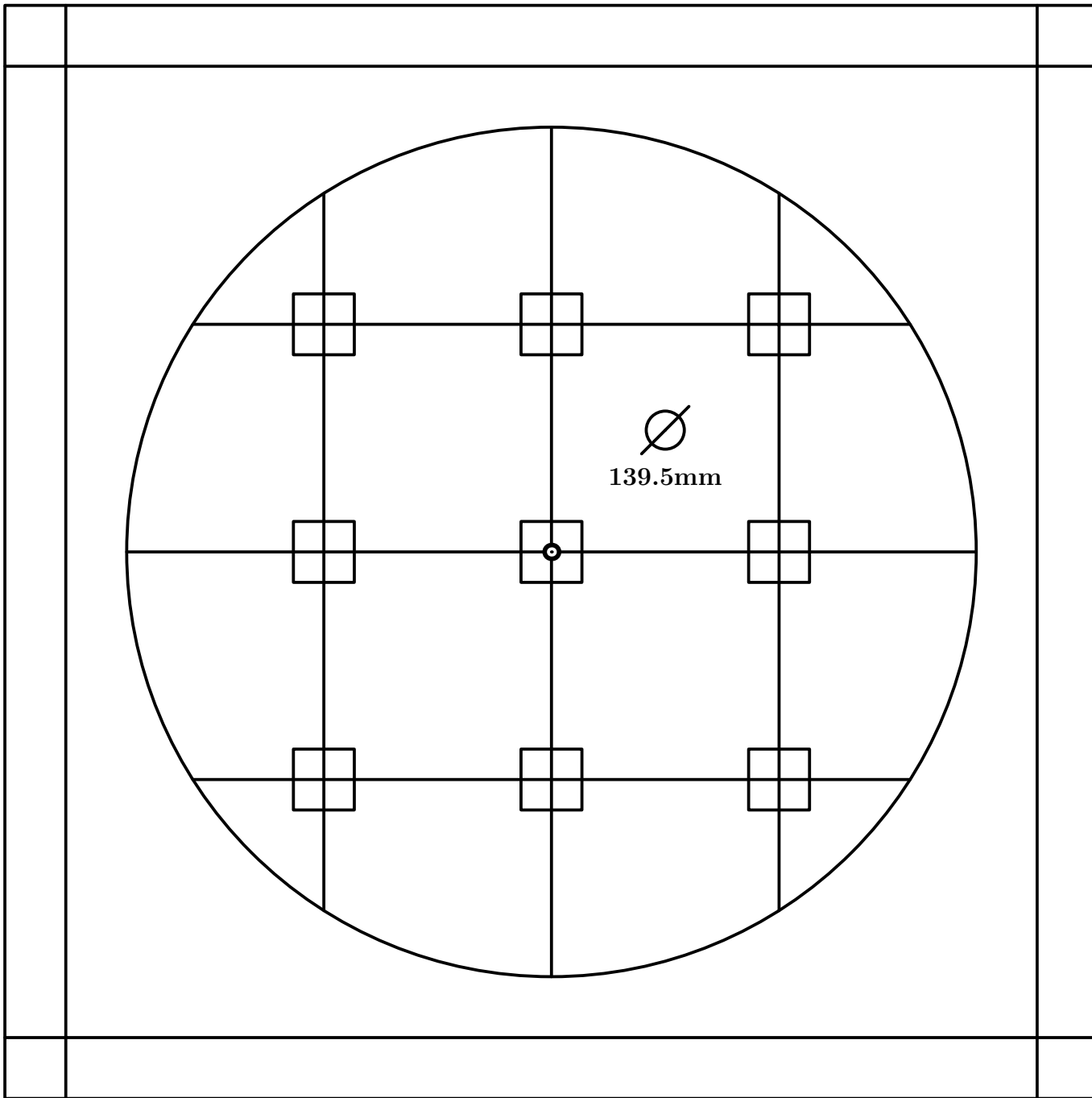

Fig. 159

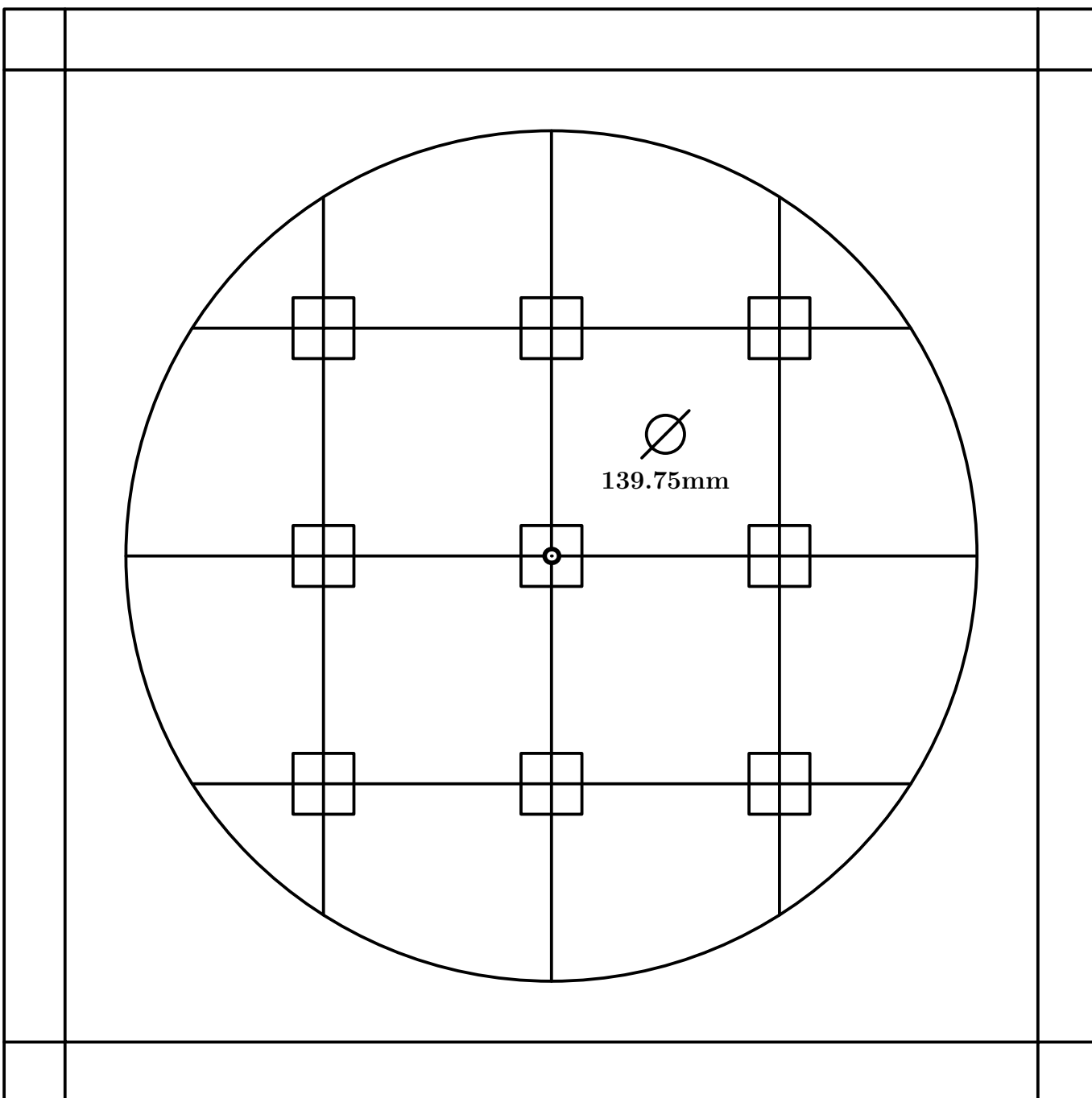

Fig. 160

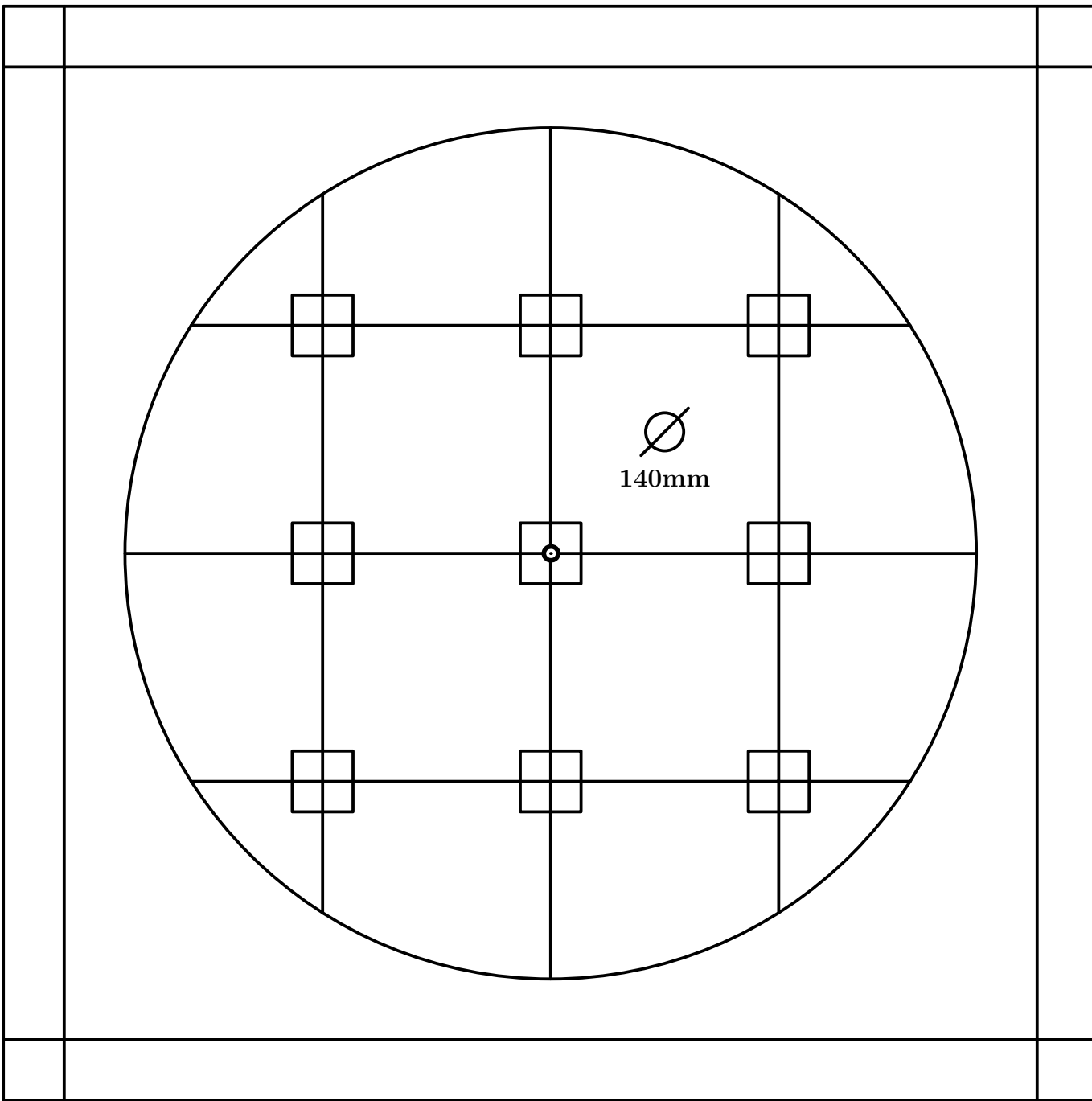

Fig. 161

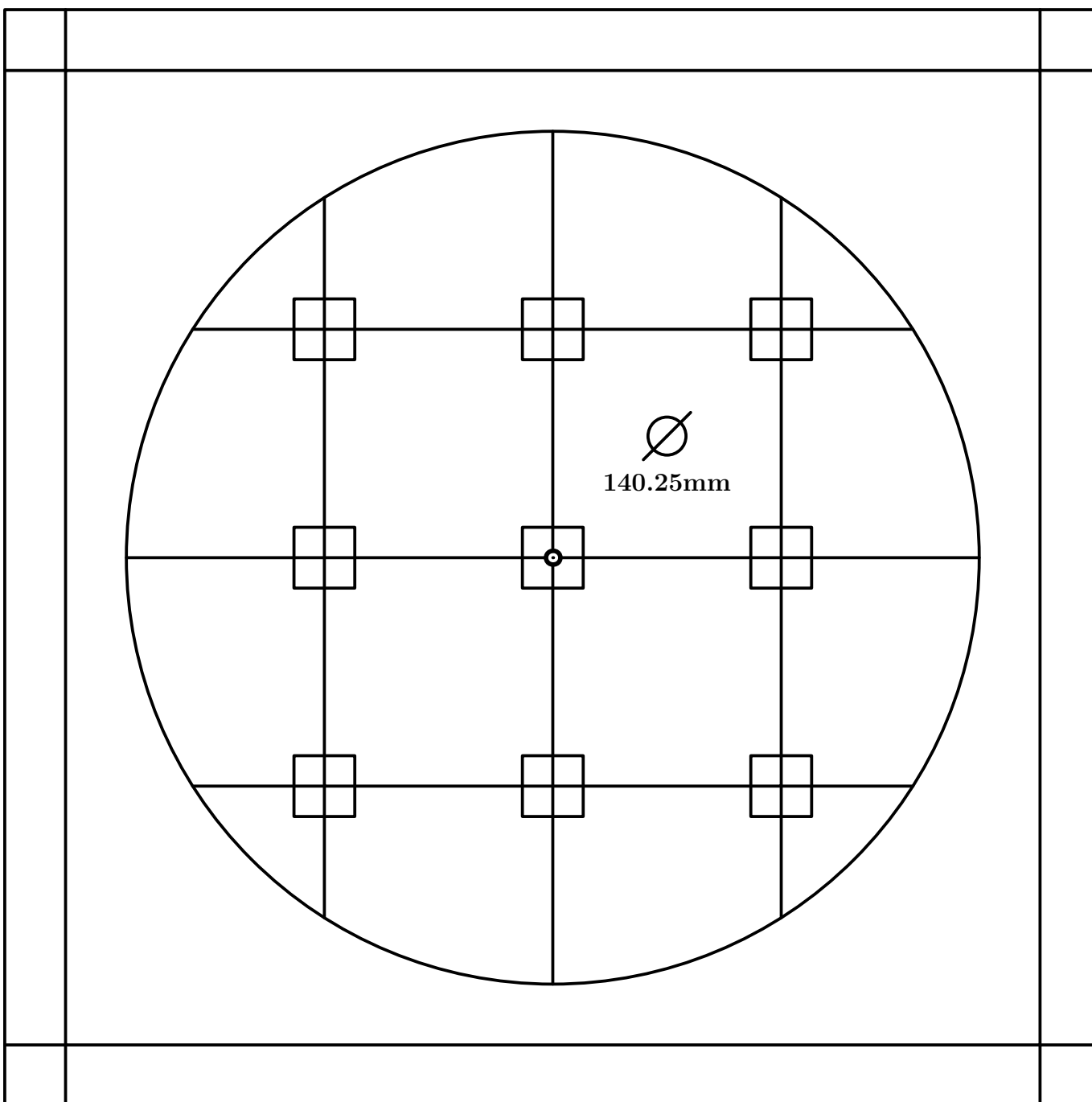

Fig. 162

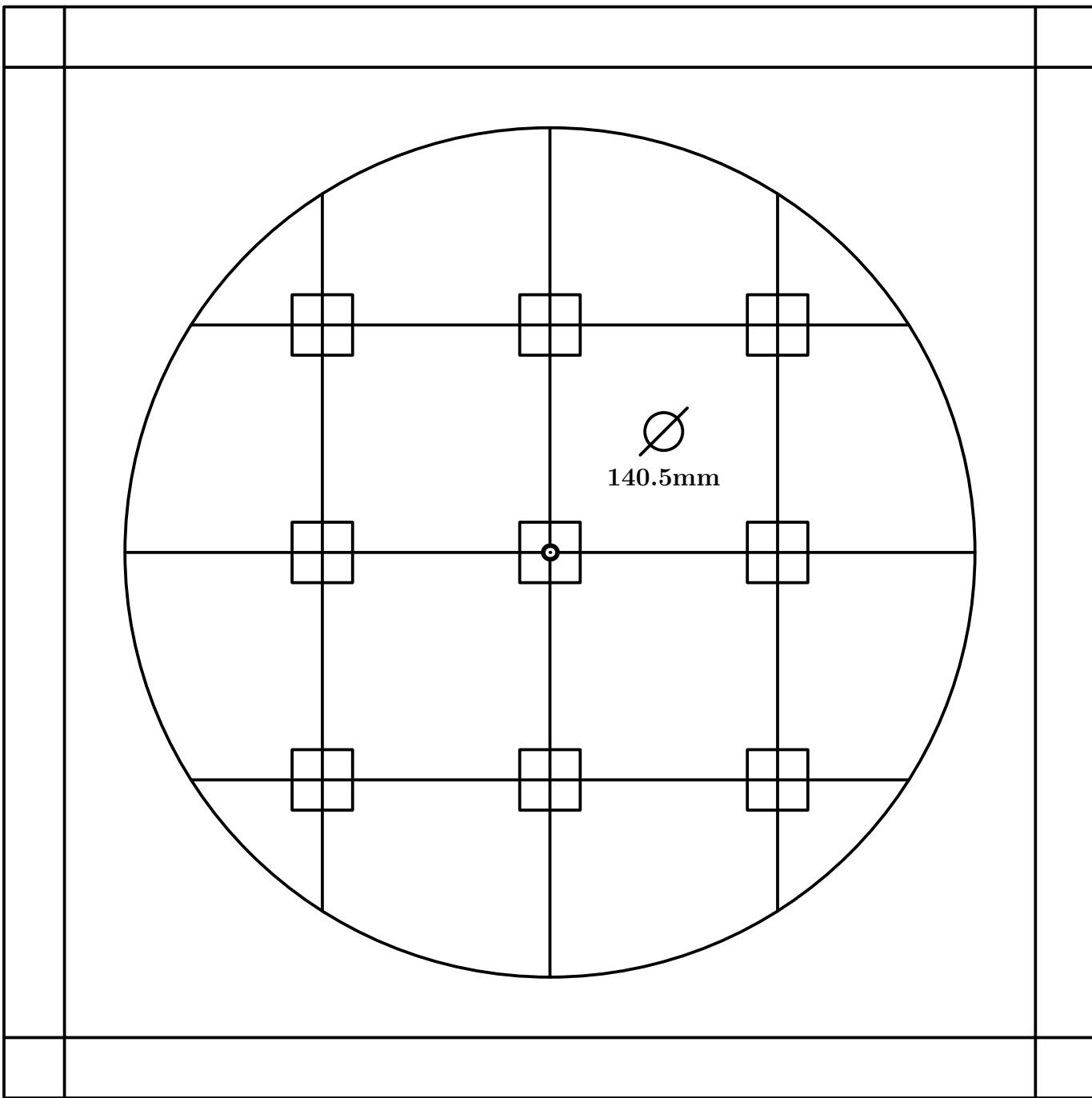

Fig. 163

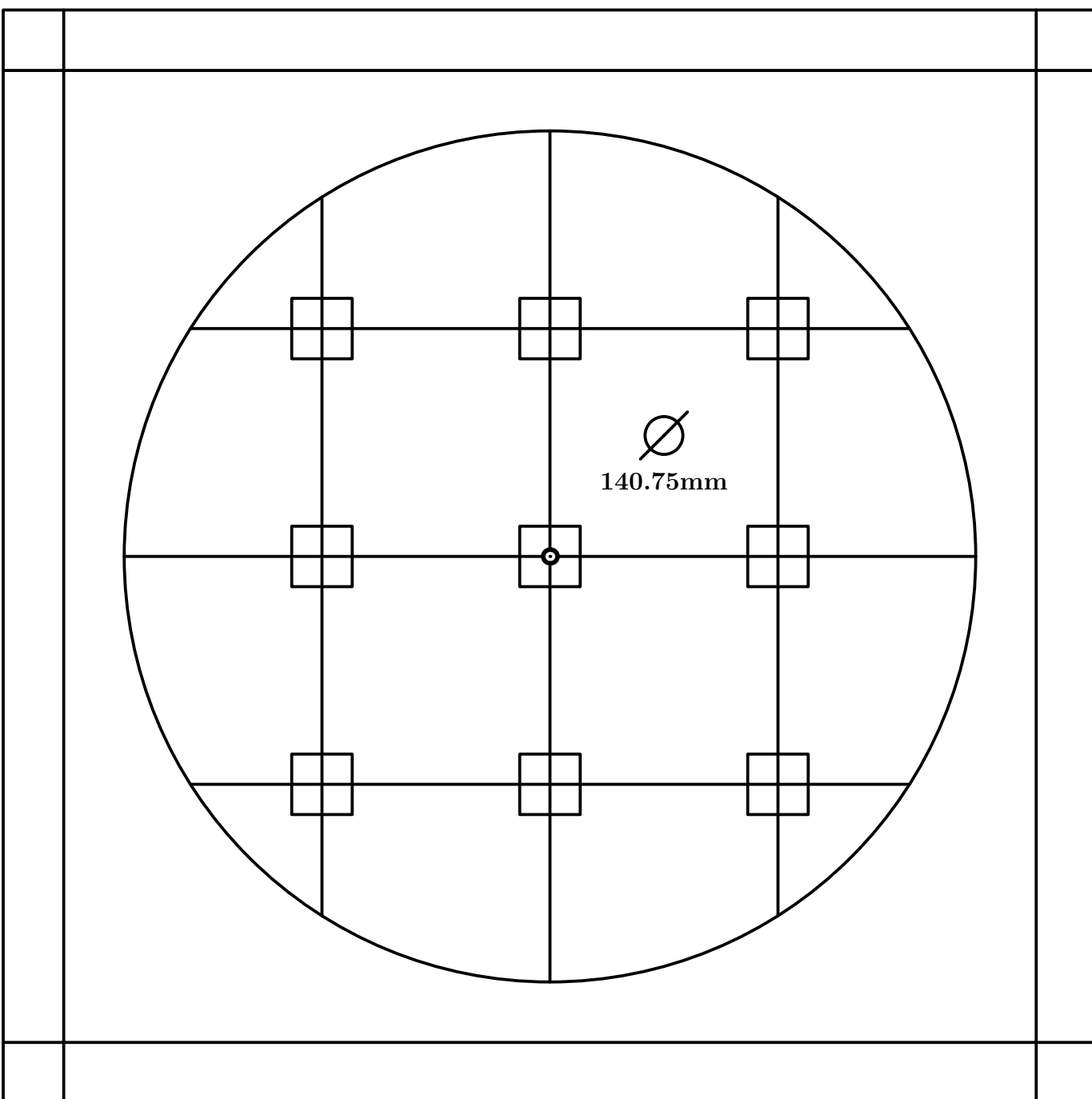

Fig. 164

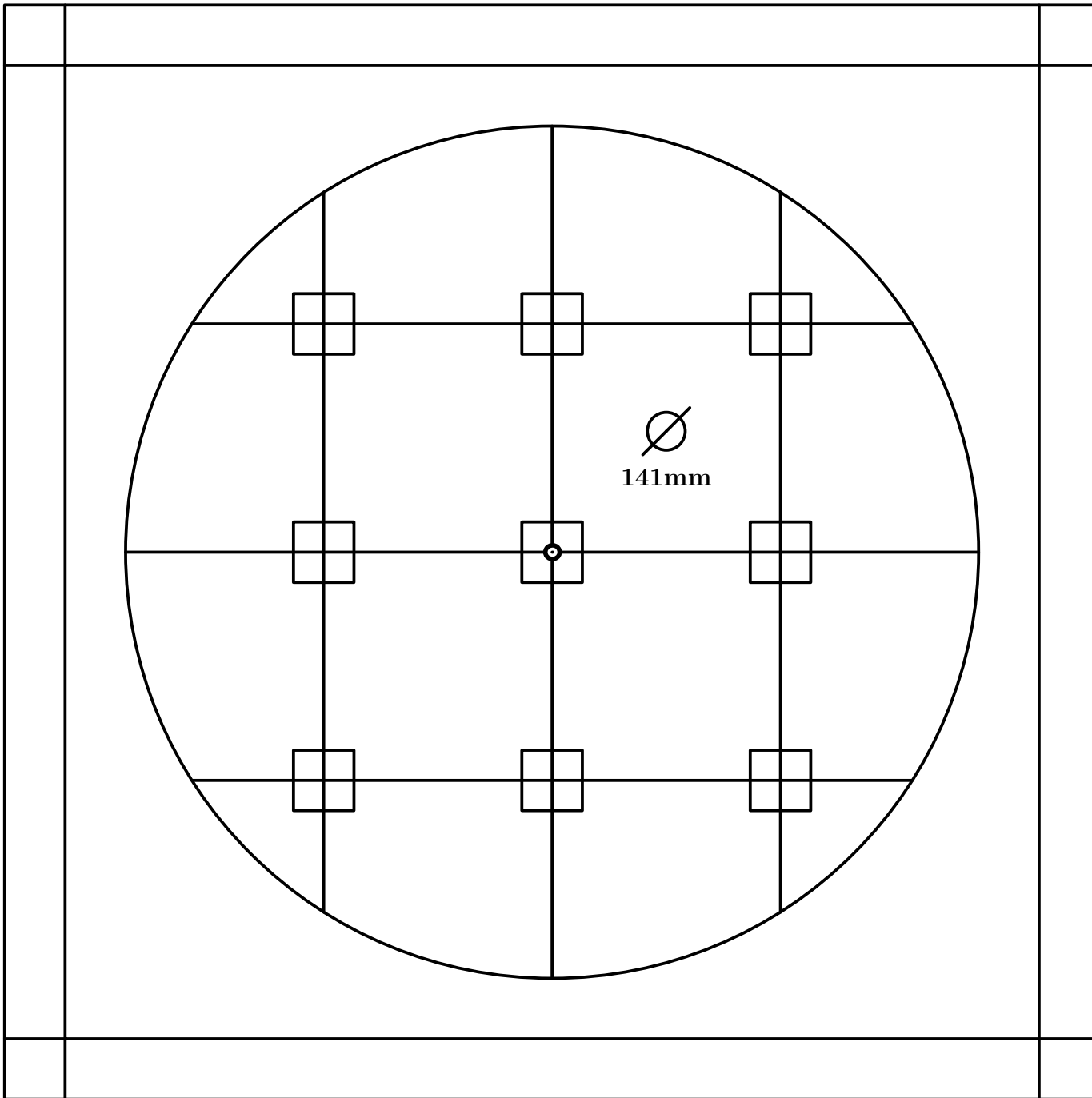

Fig. 165

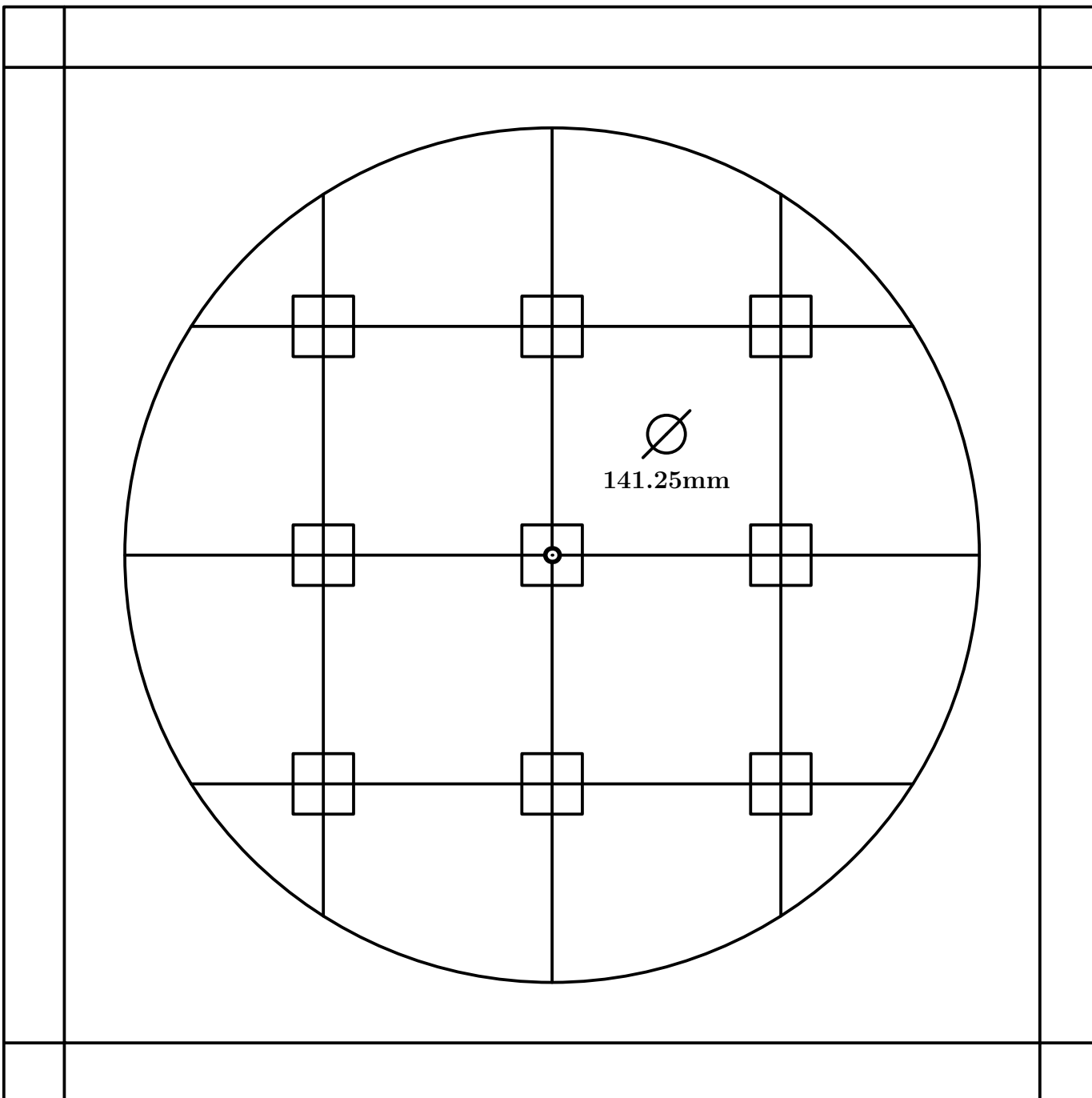

Fig. 166

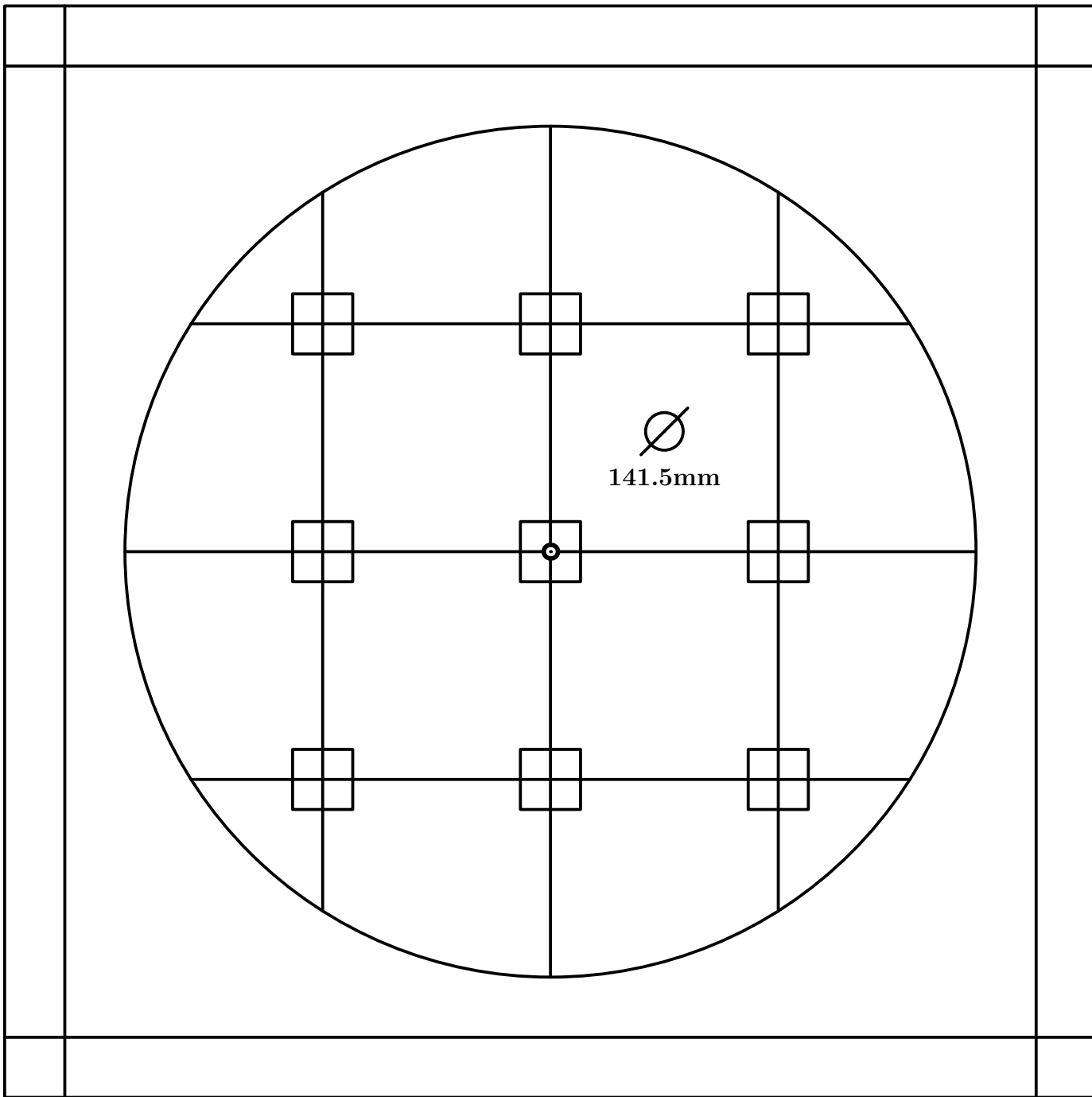

Fig. 167

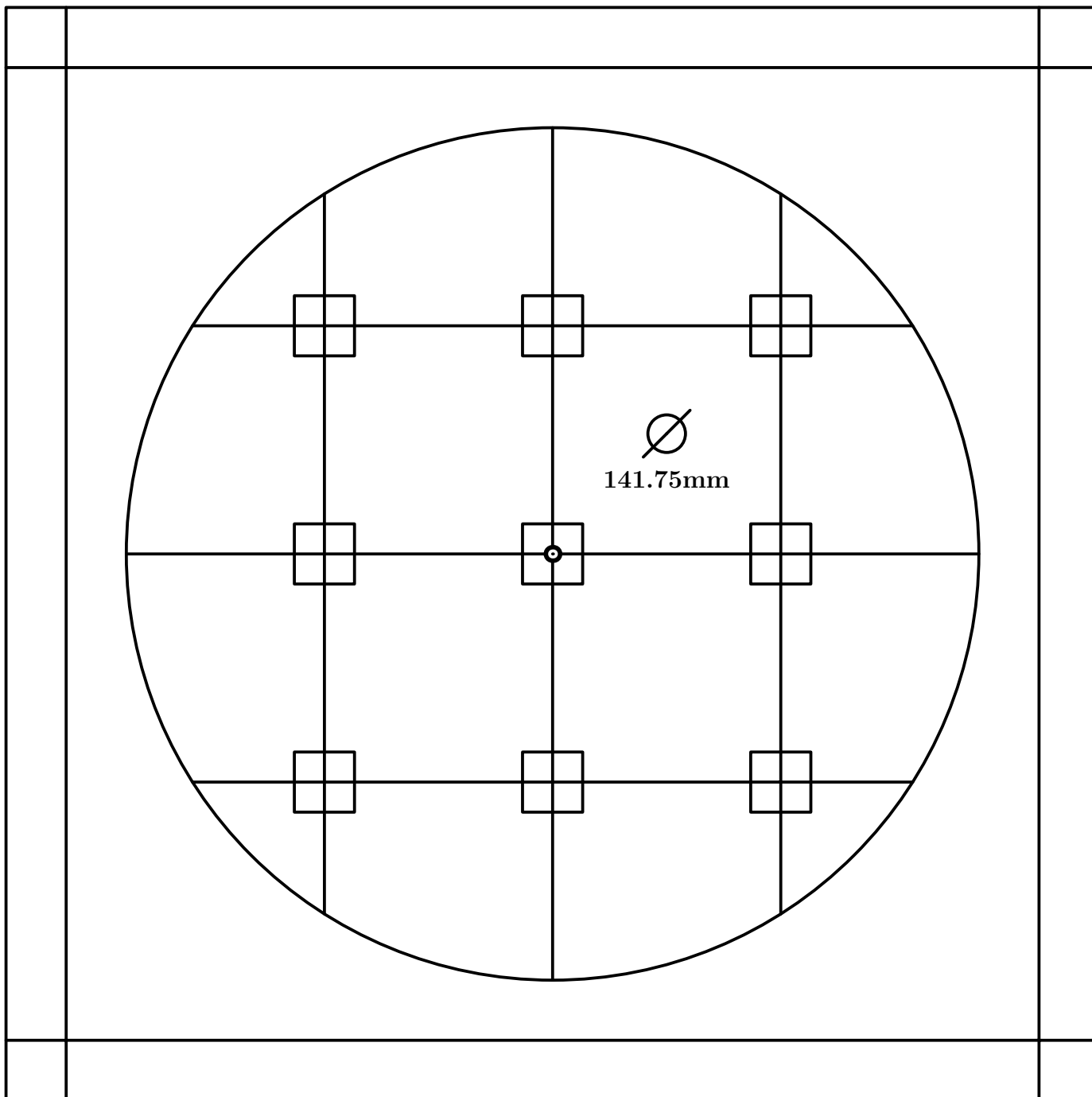

Fig. 168

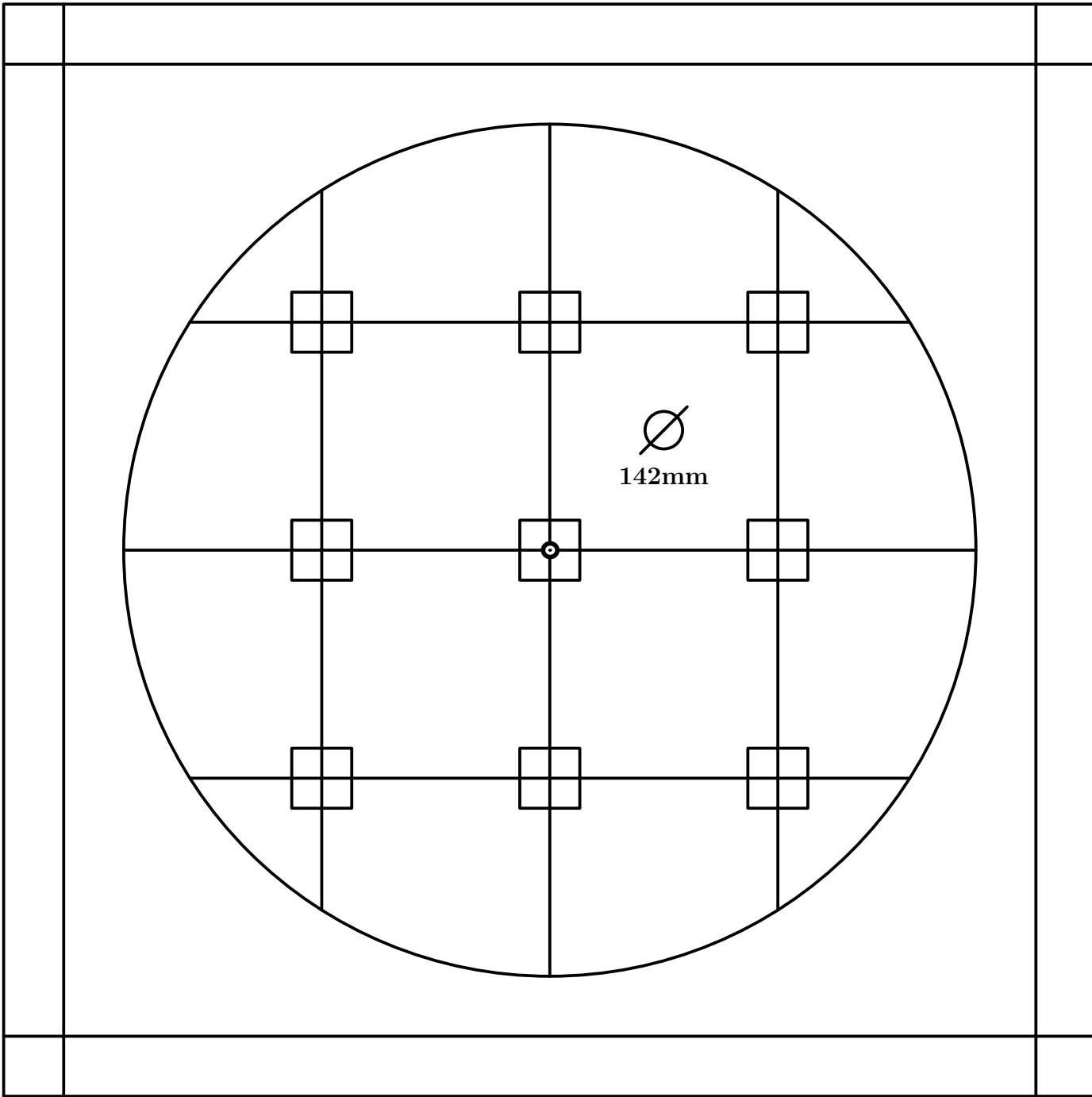

Fig. 169

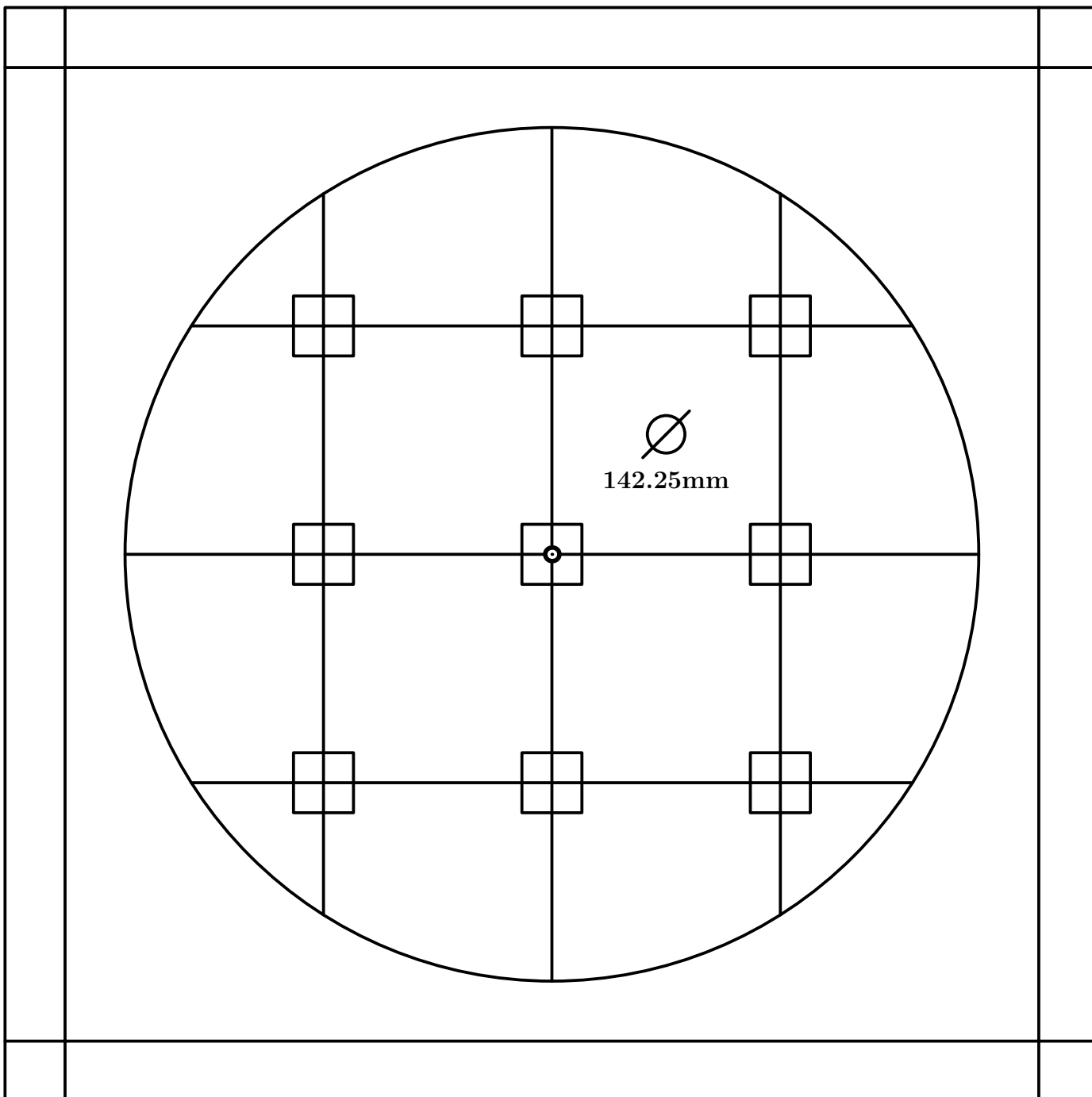

Fig. 170

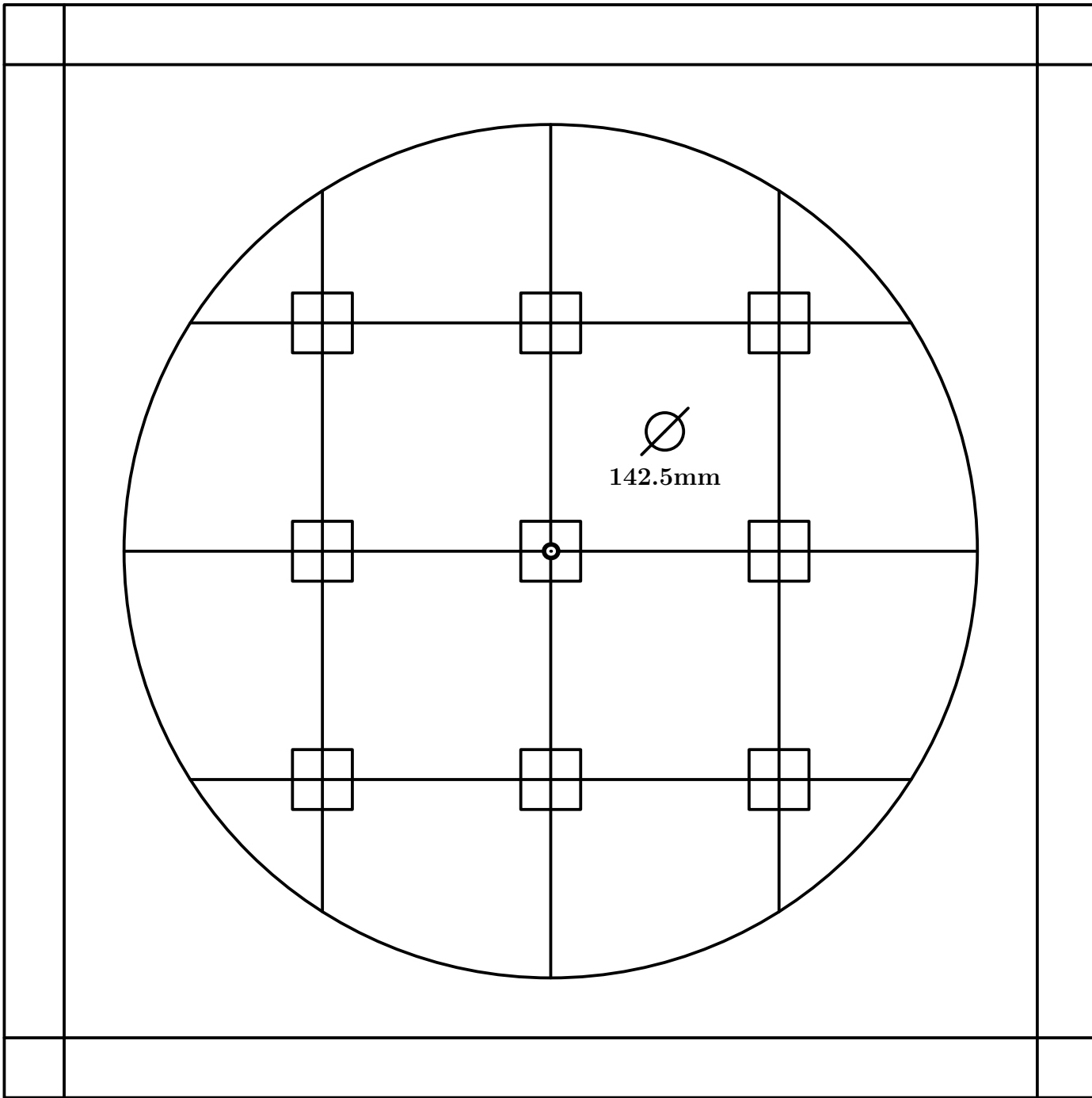

Fig. 171

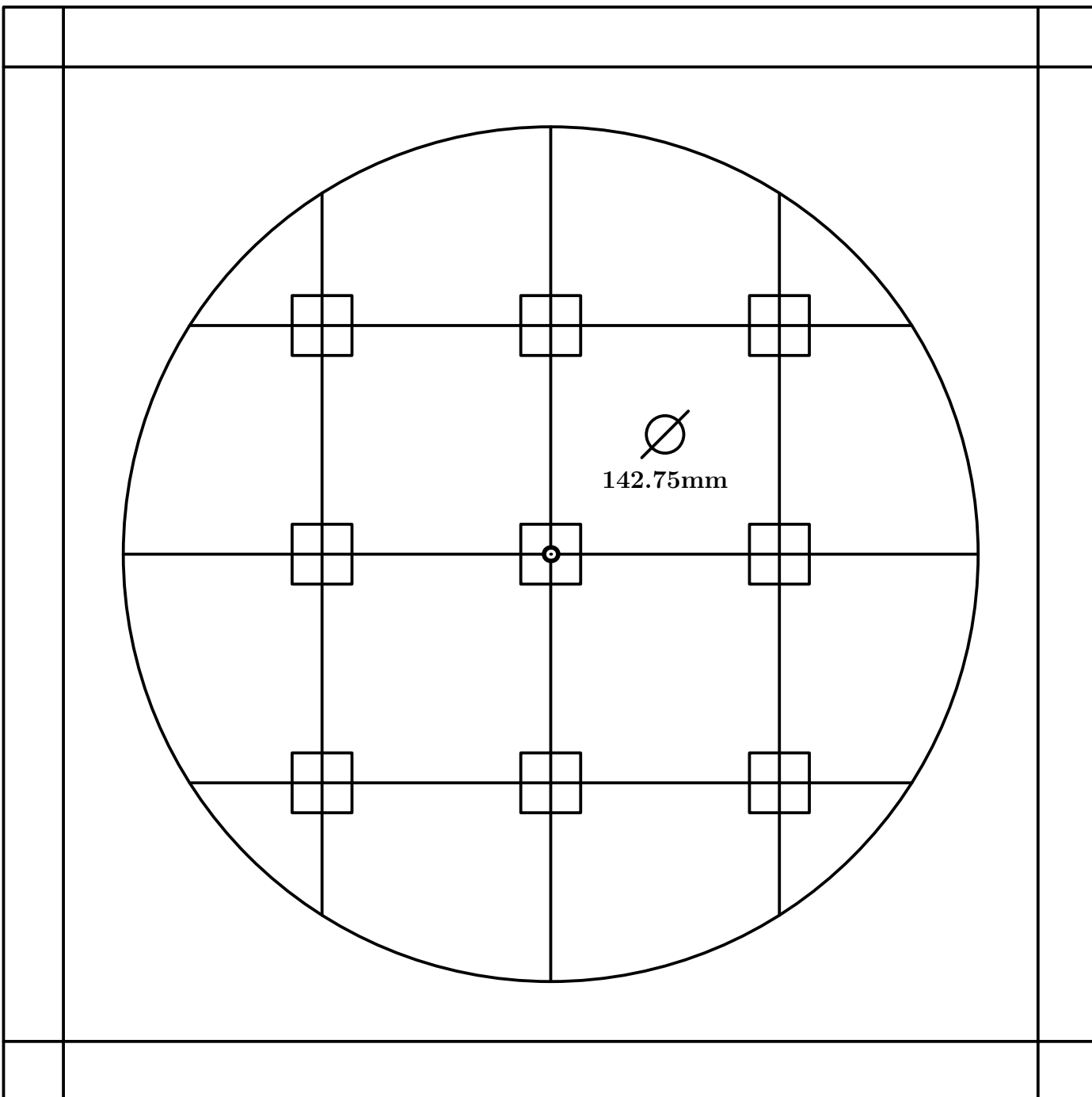

Fig. 172

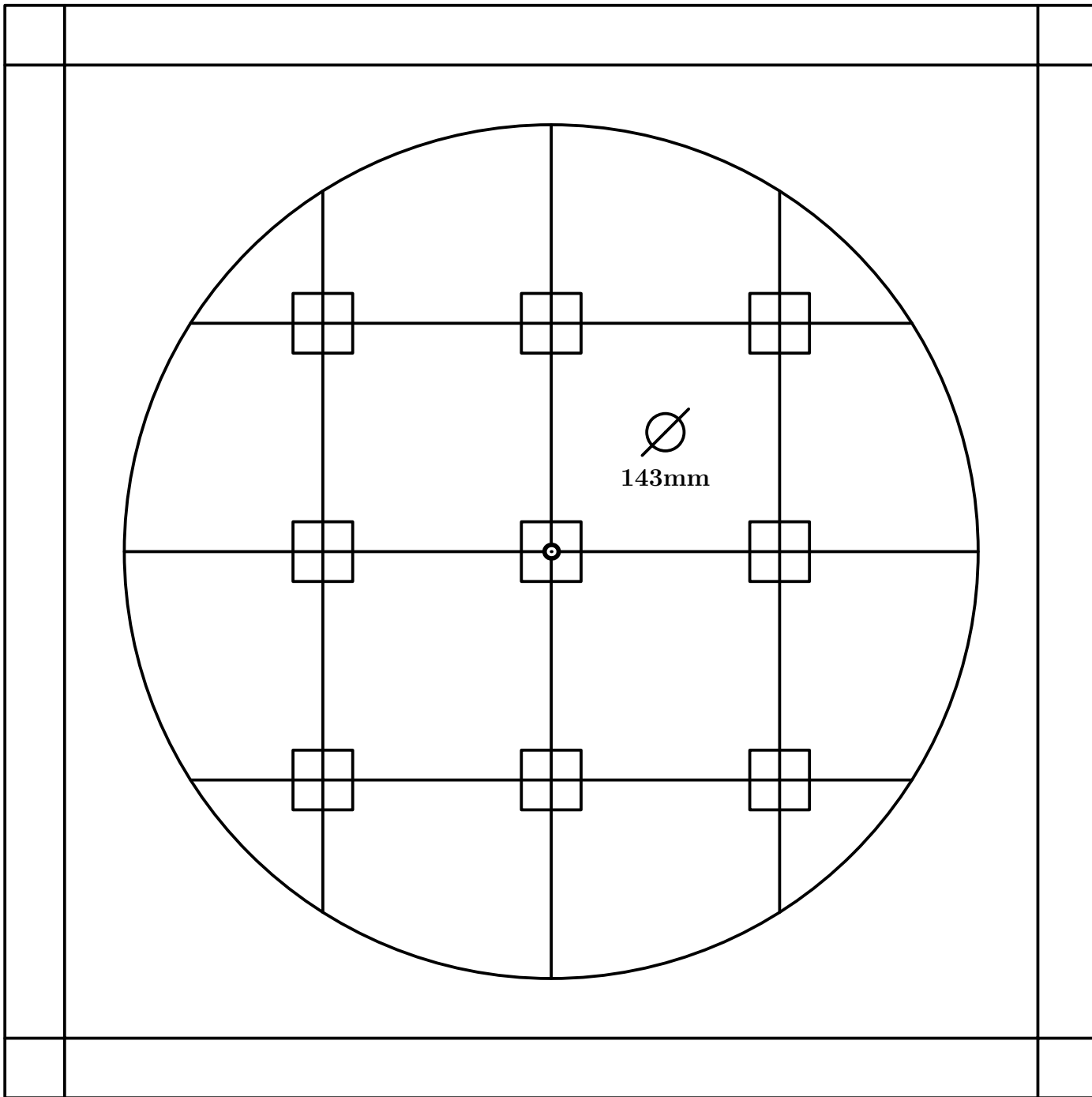

Fig. 173

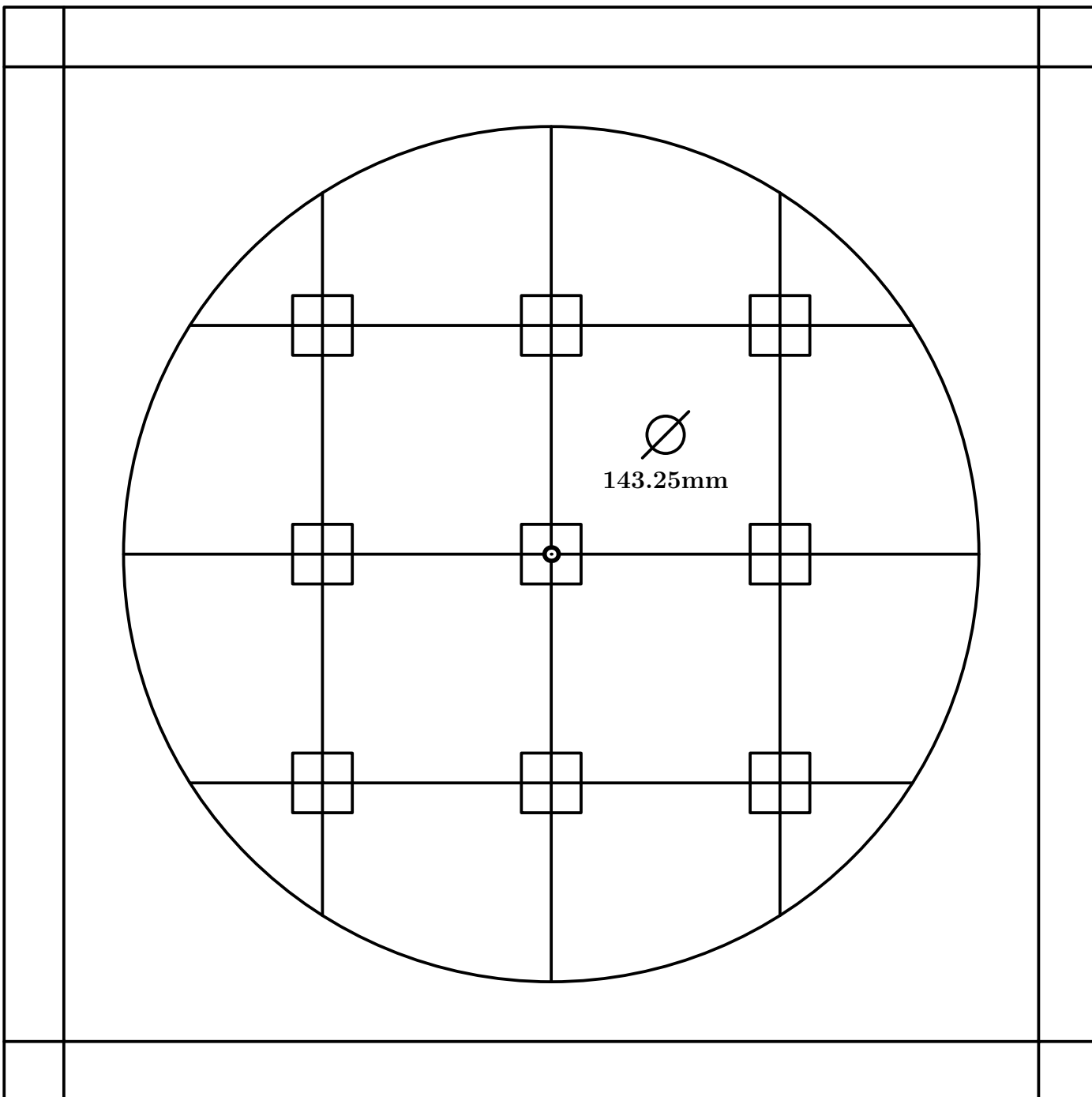

Fig. 174

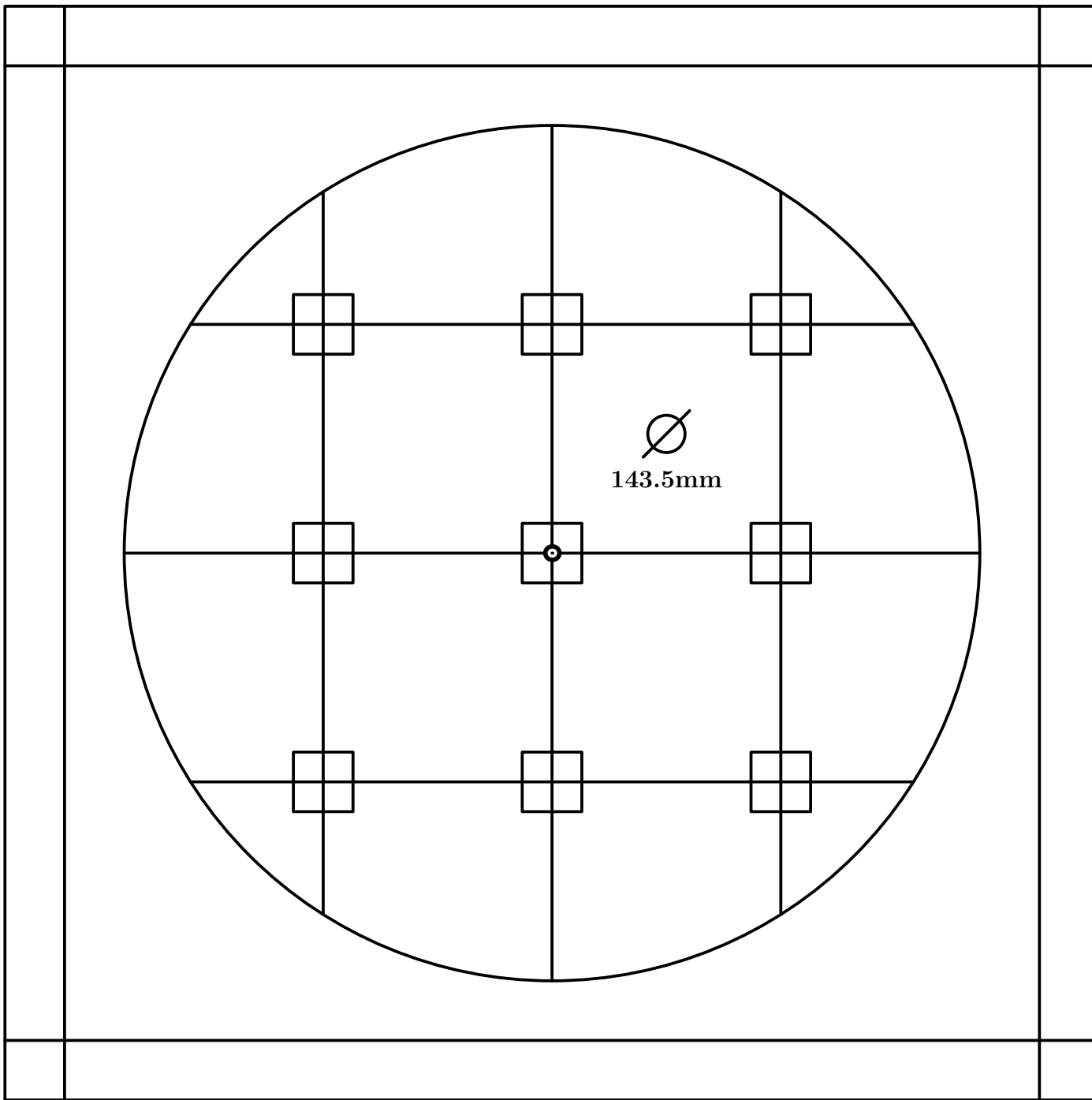

Fig. 175

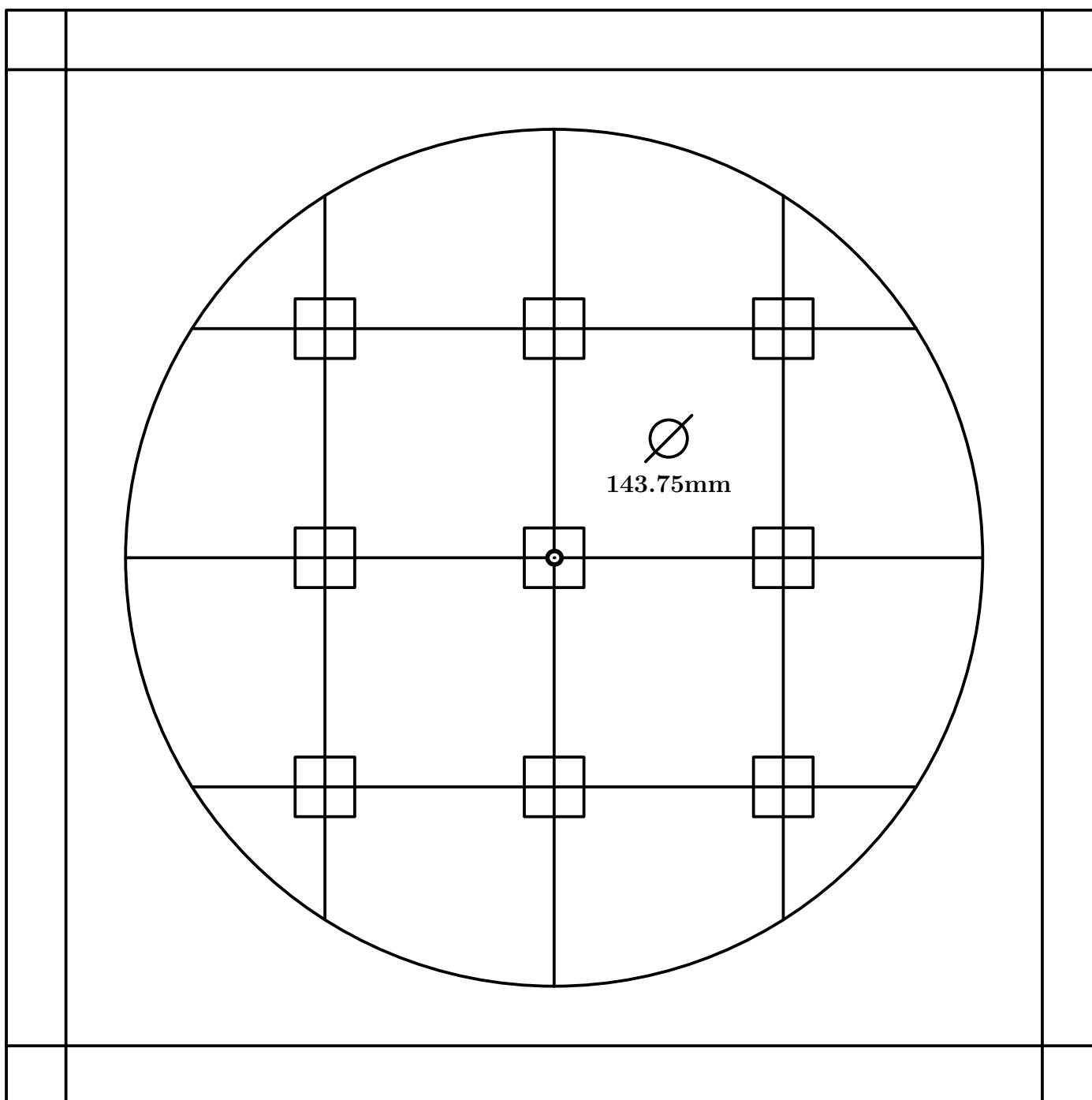

Fig. 176

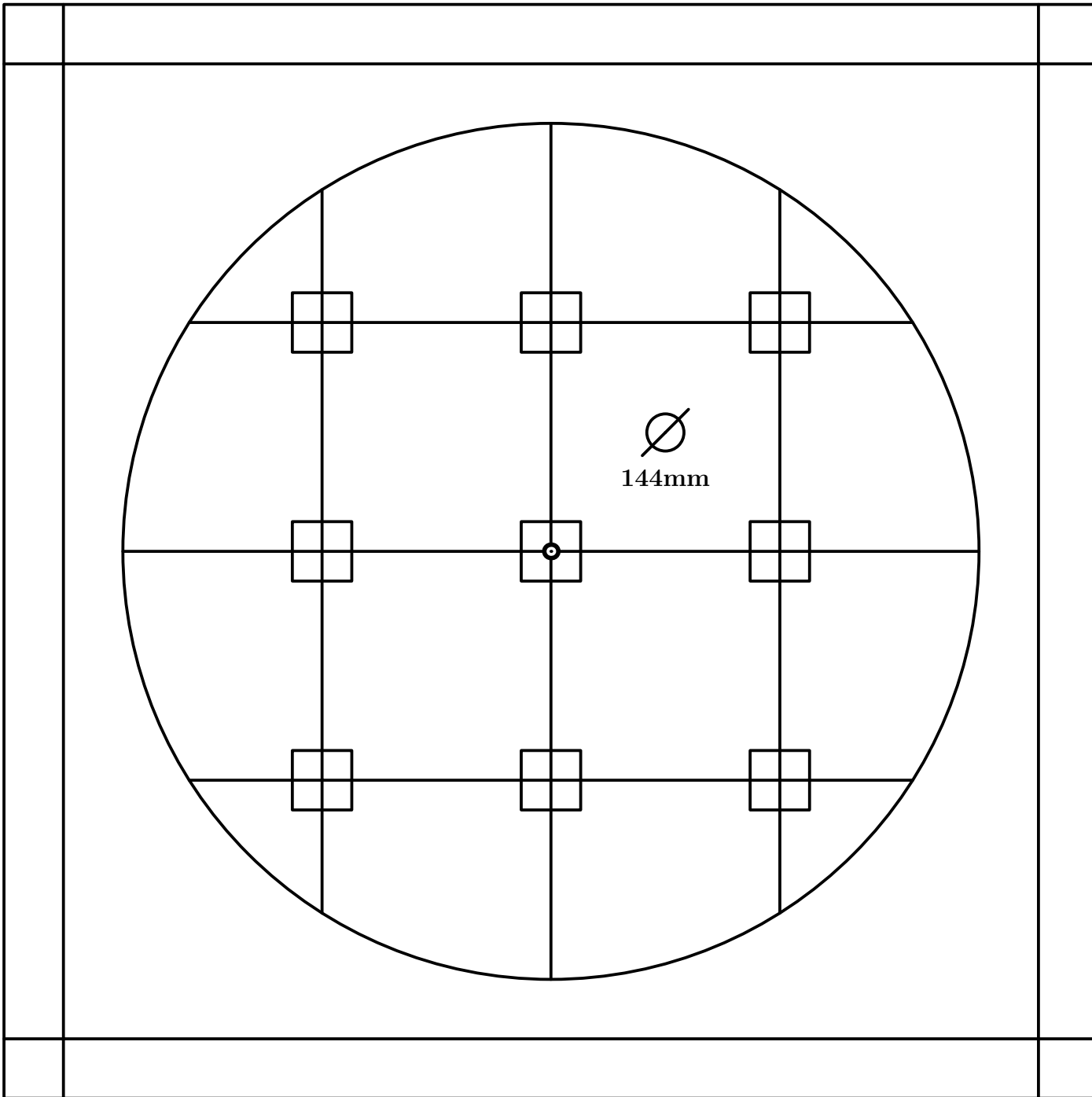

Fig. 177

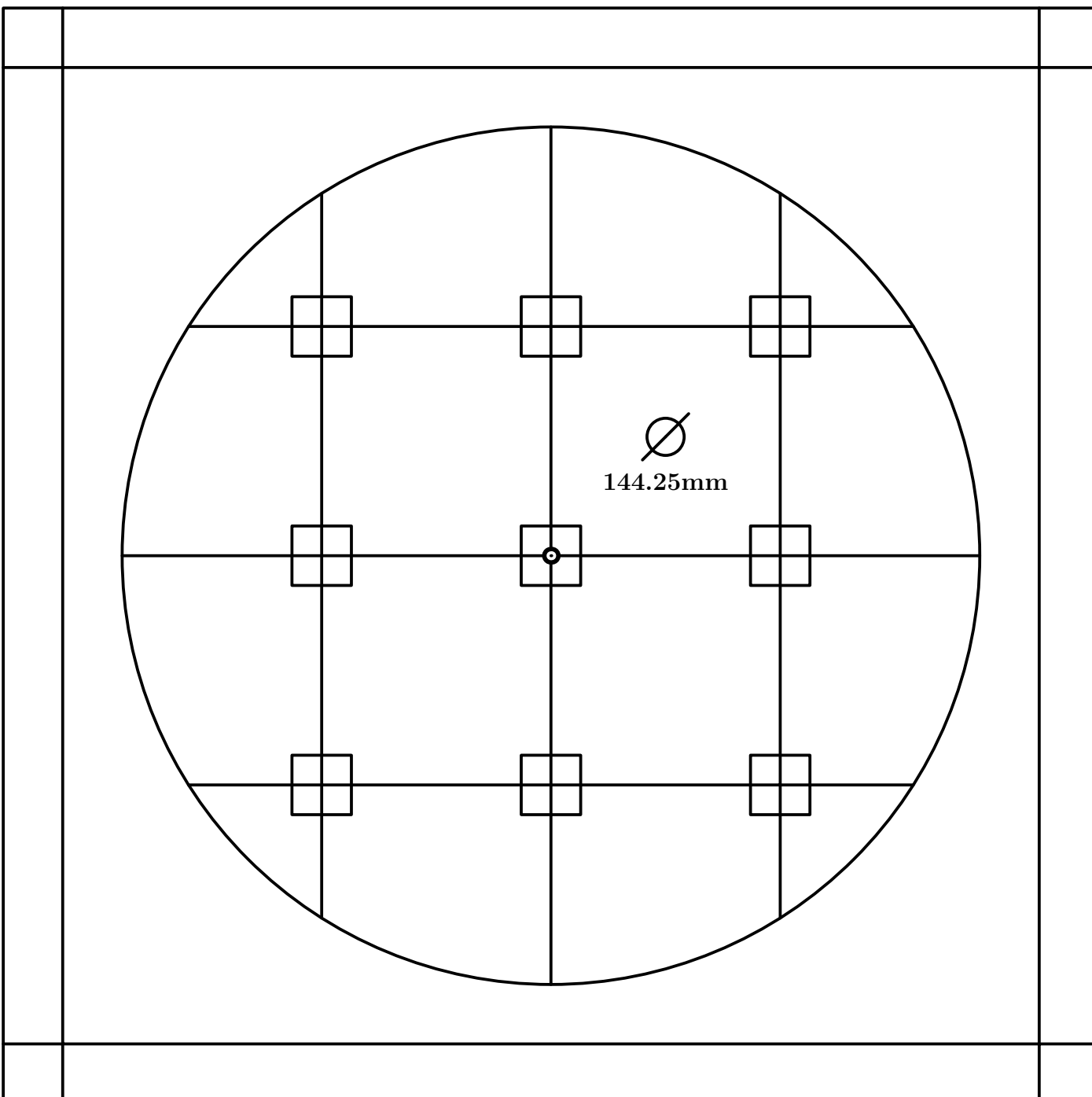

Fig. 178

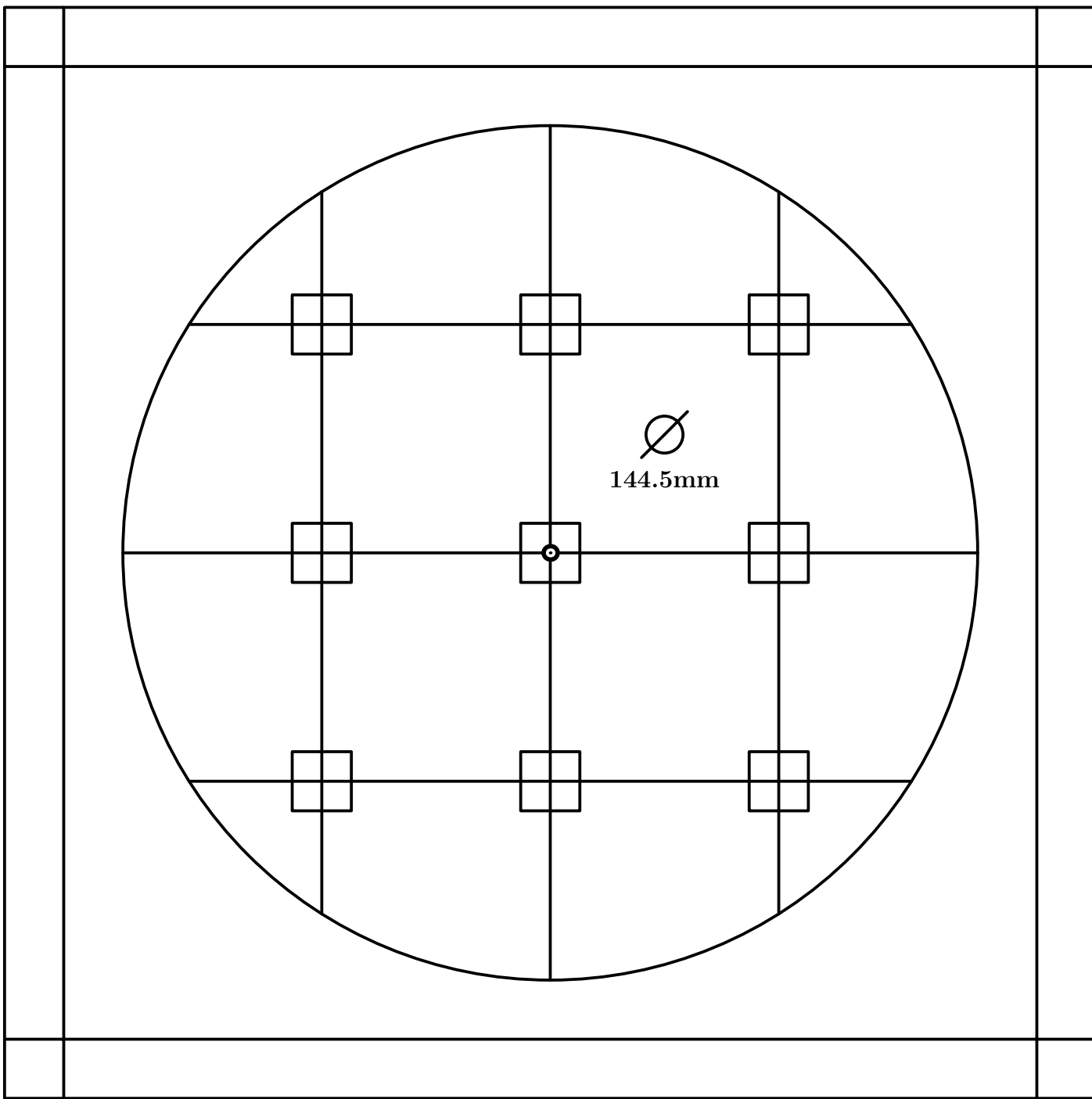

Fig. 179

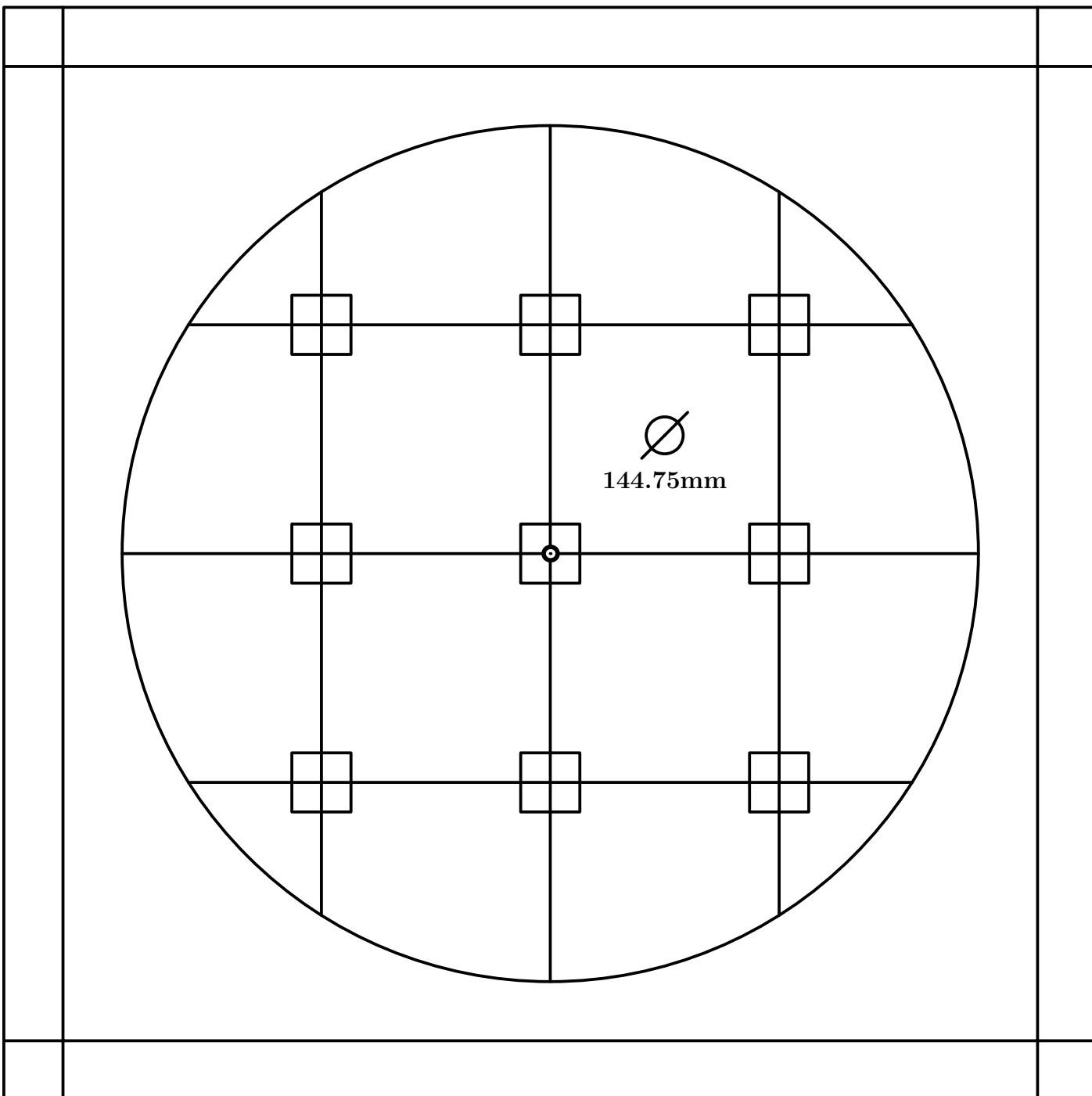

Fig. 180

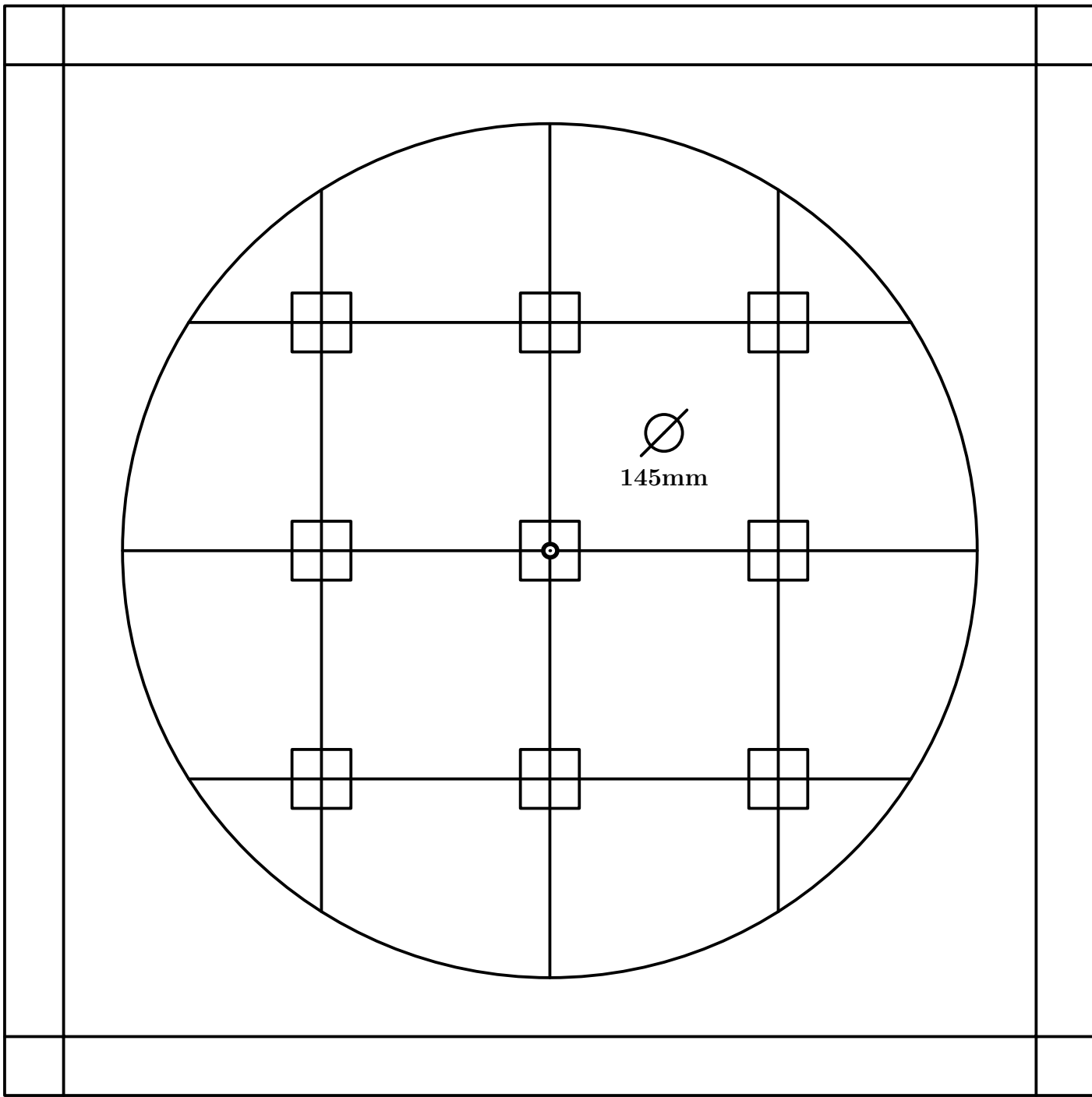

Fig. 181

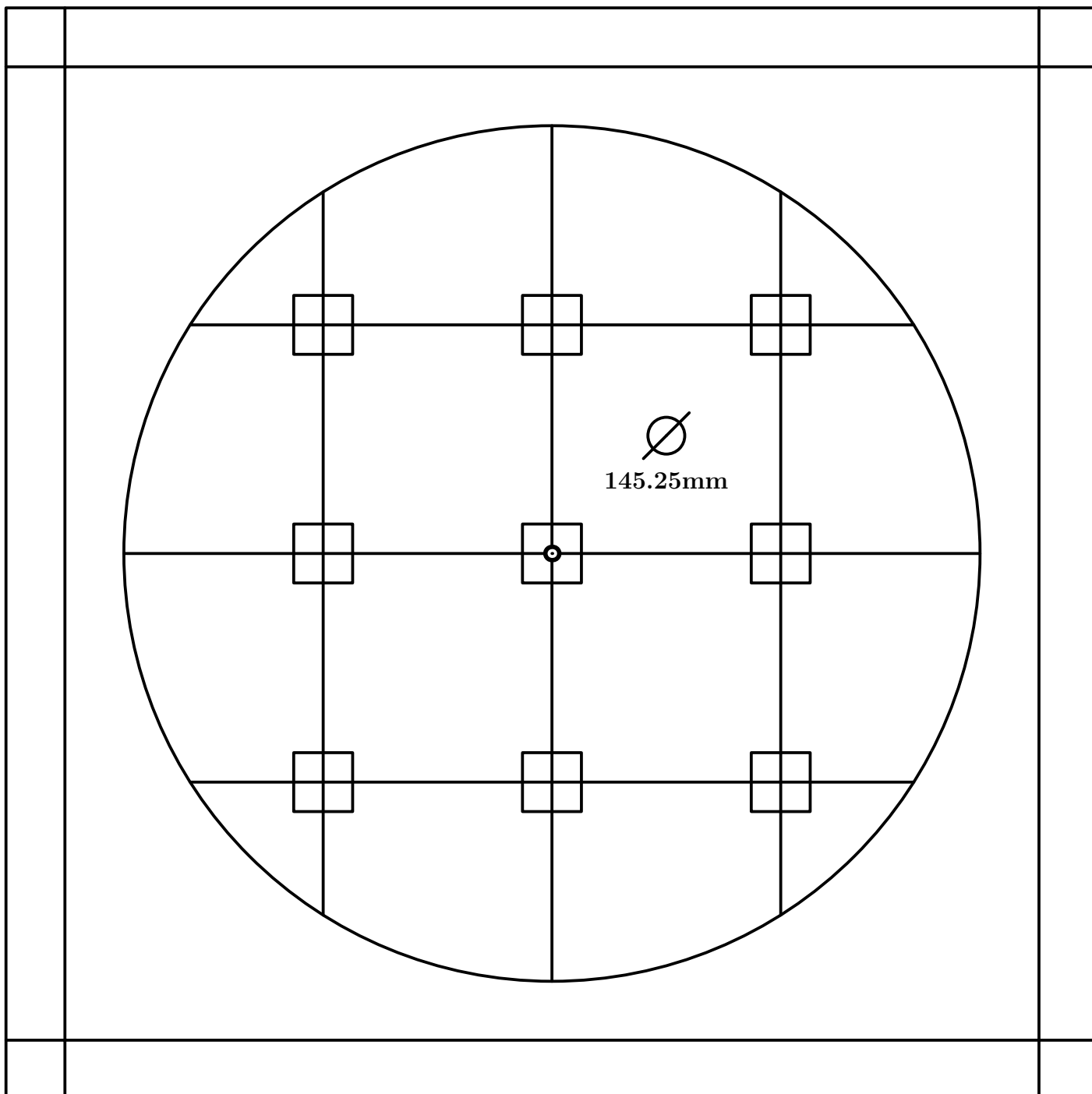

Fig. 182

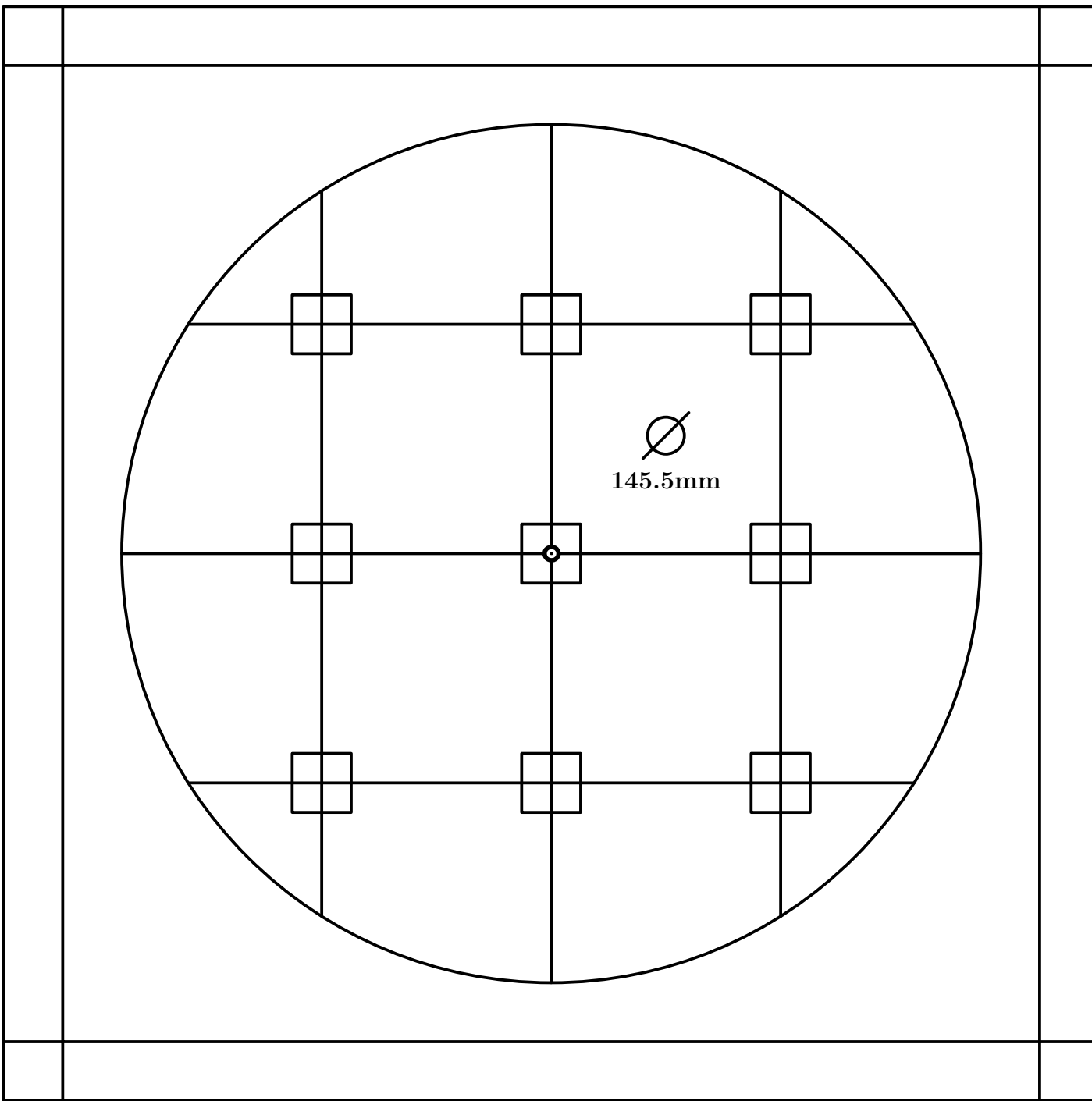

Fig. 183

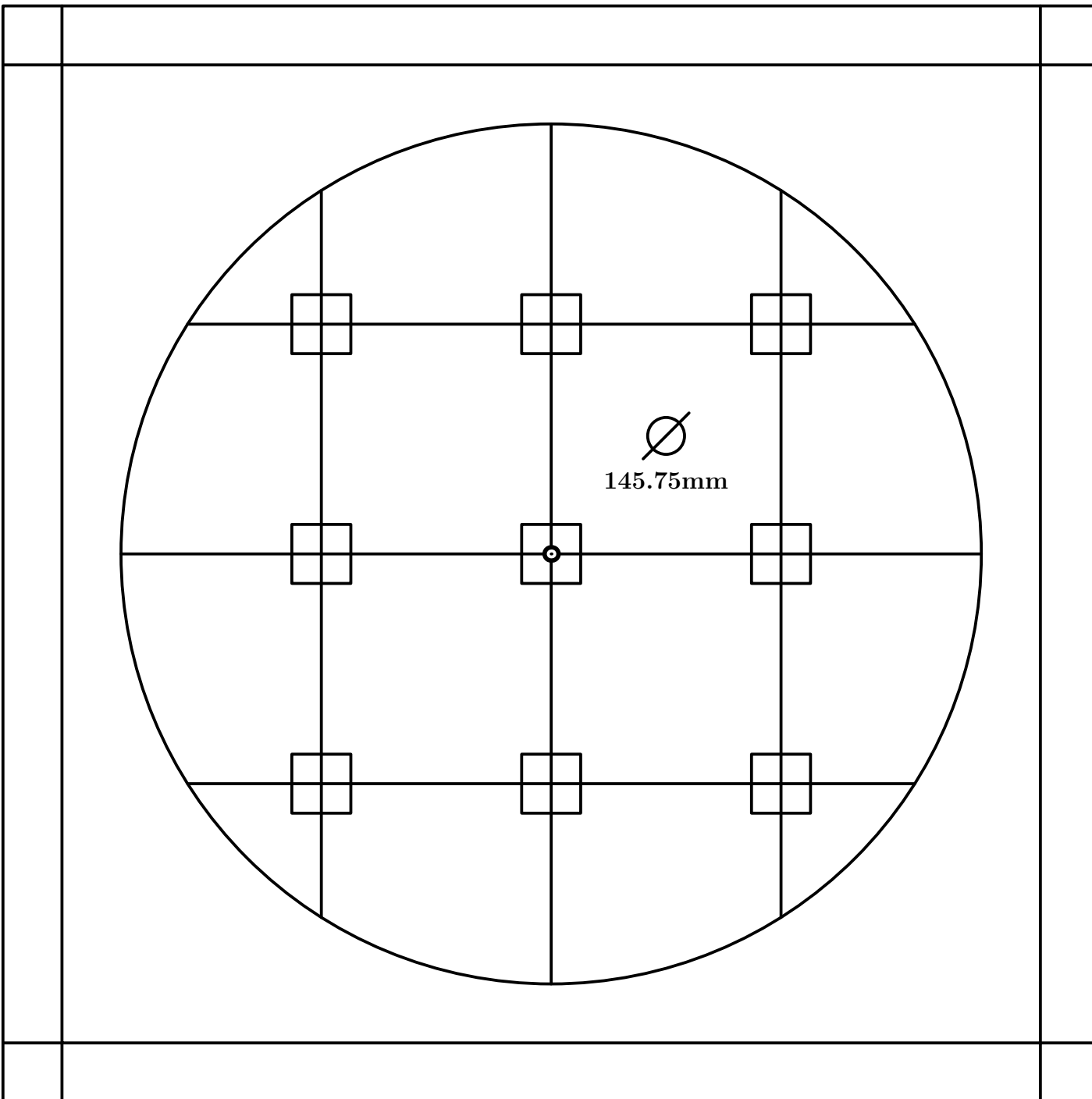

Fig. 184

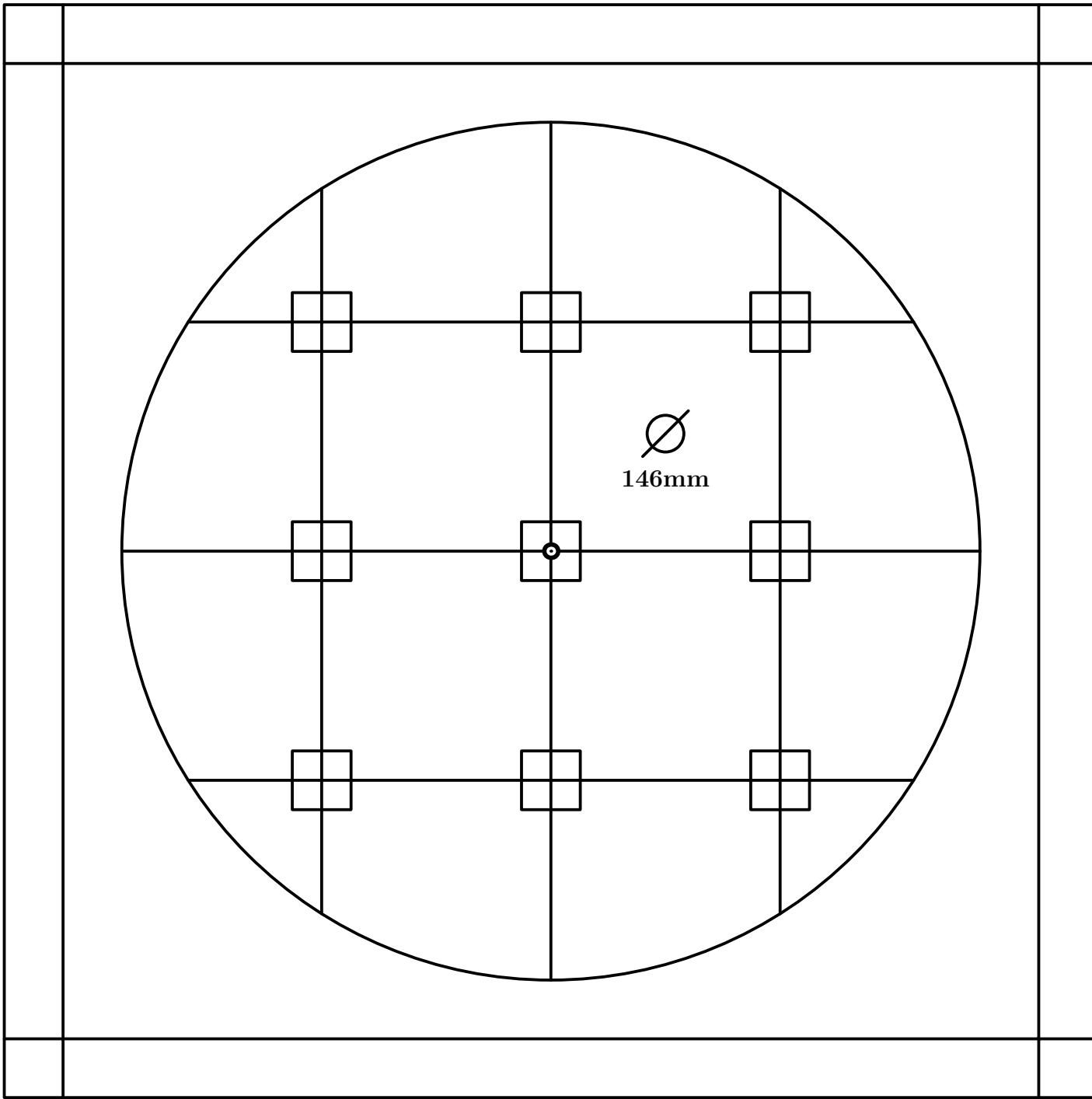

Fig. 185

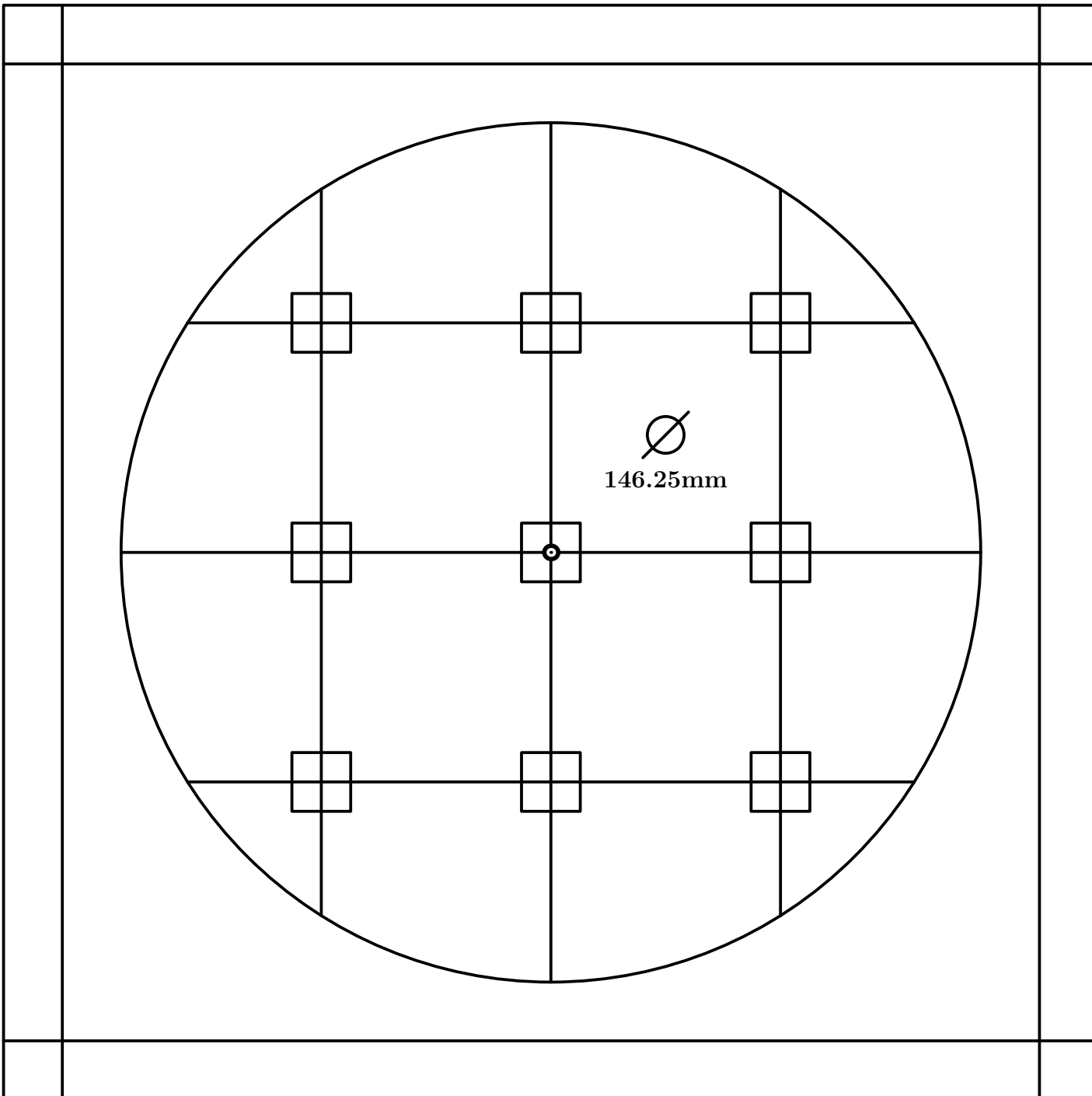

Fig. 186

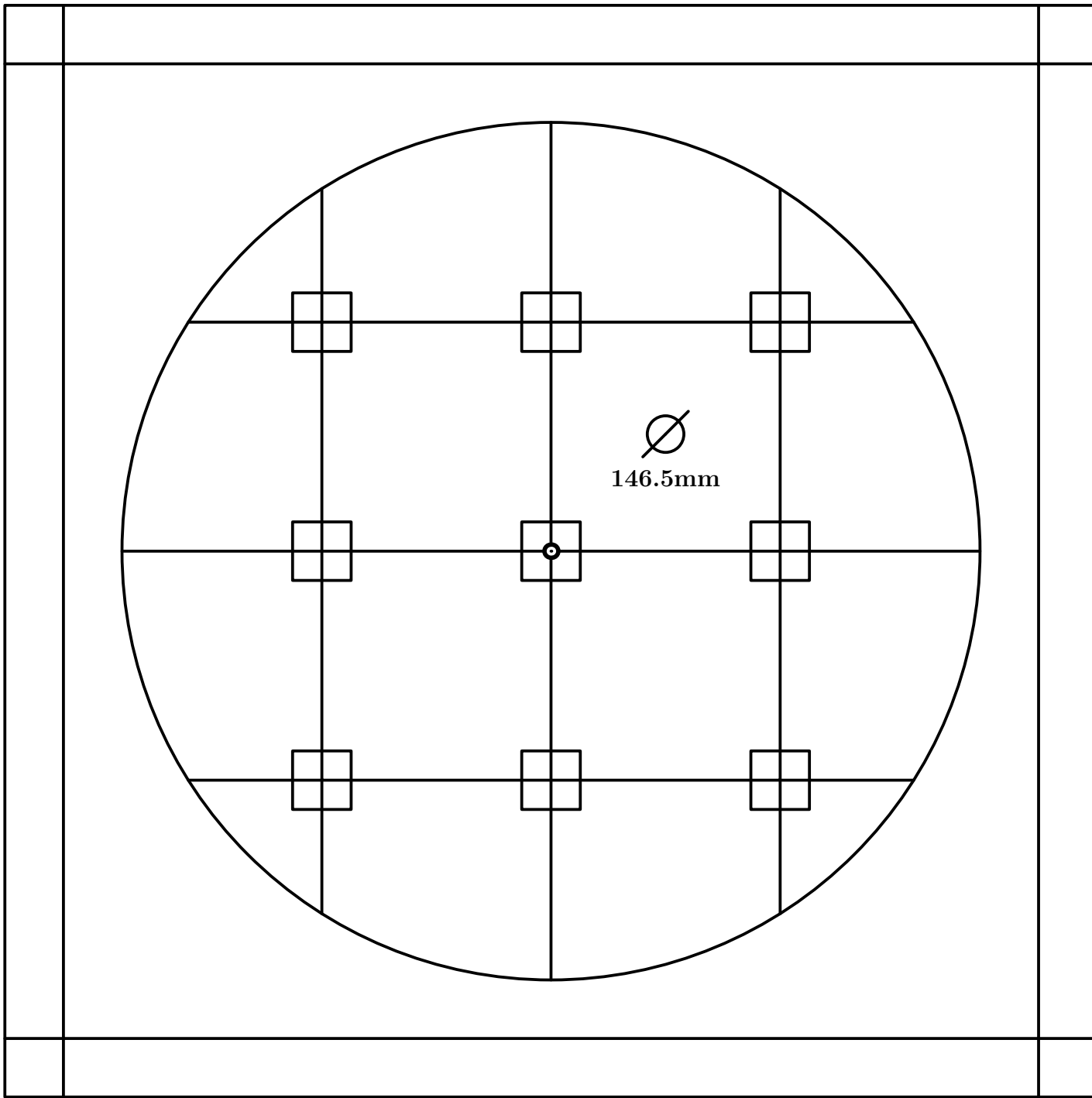

Fig. 187

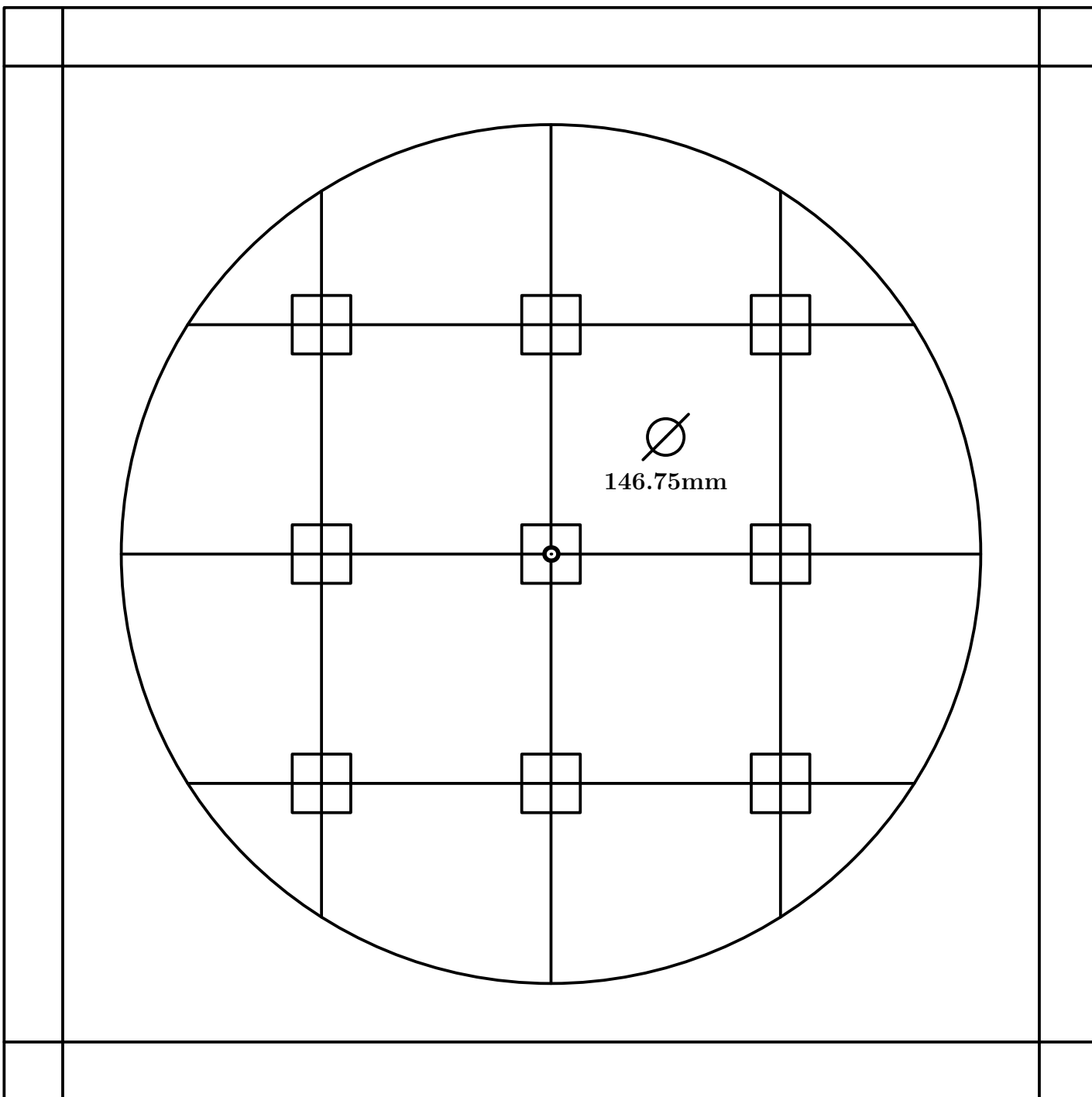

Fig. 188

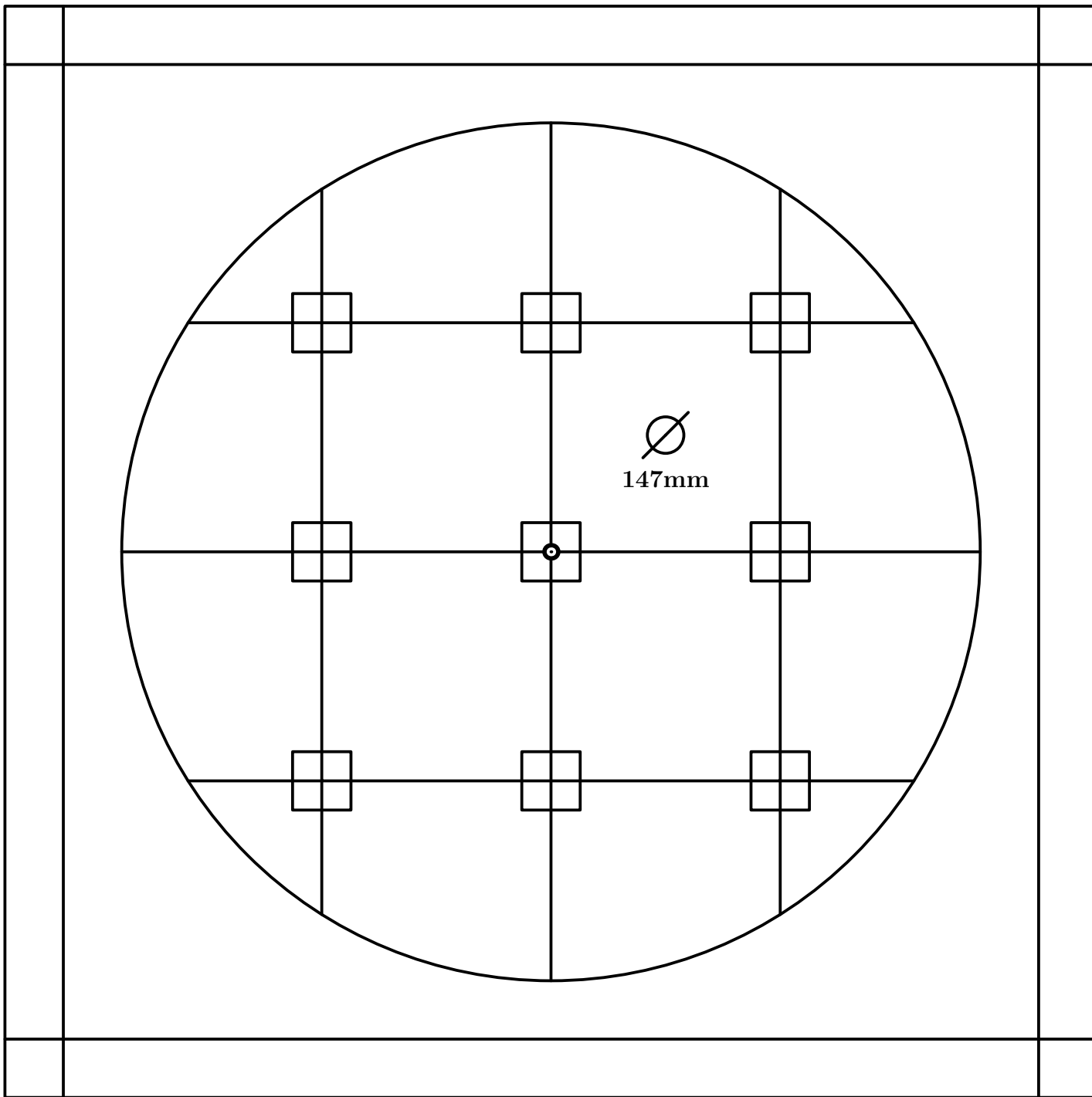

Fig. 189

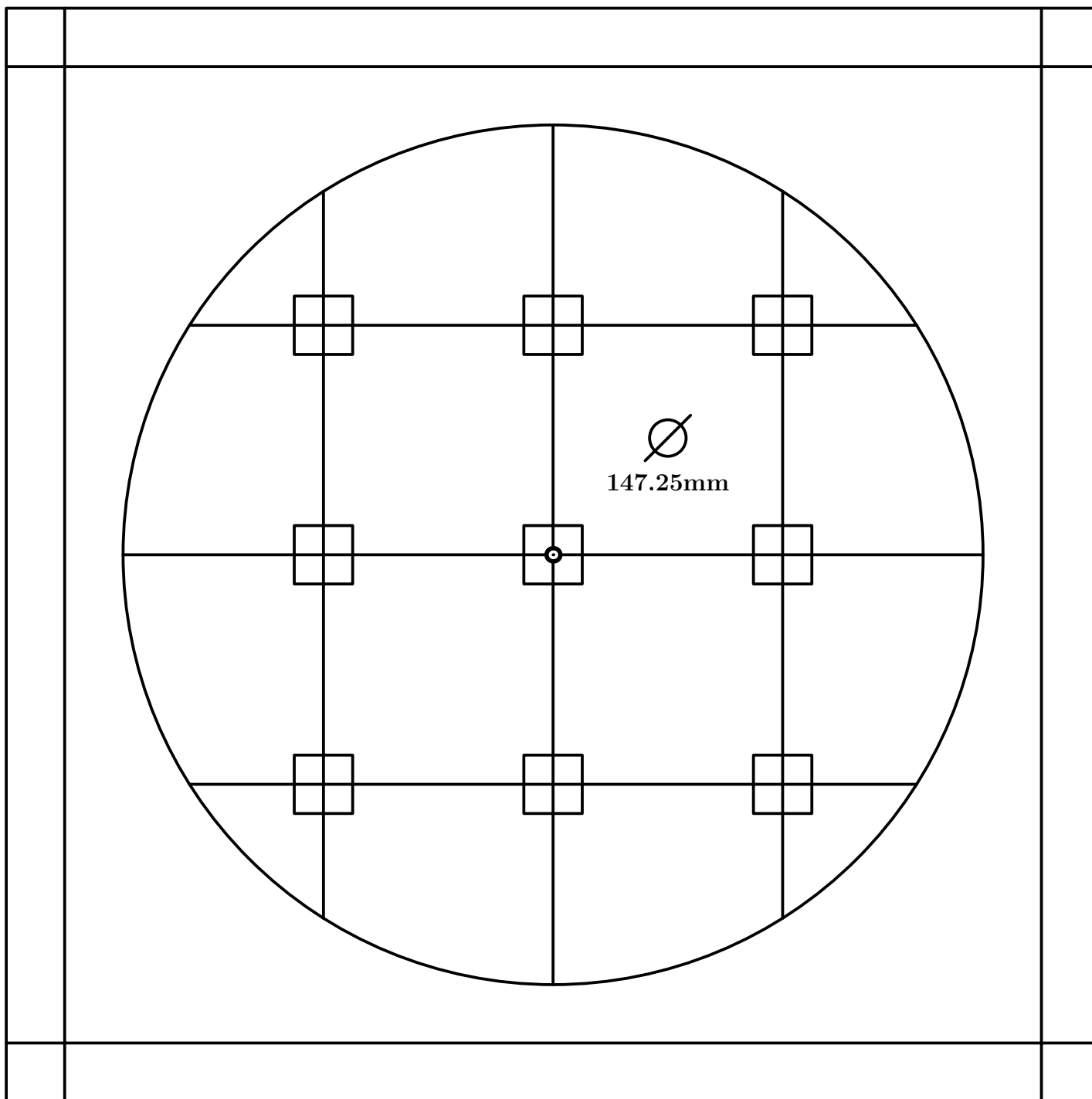

Fig. 190

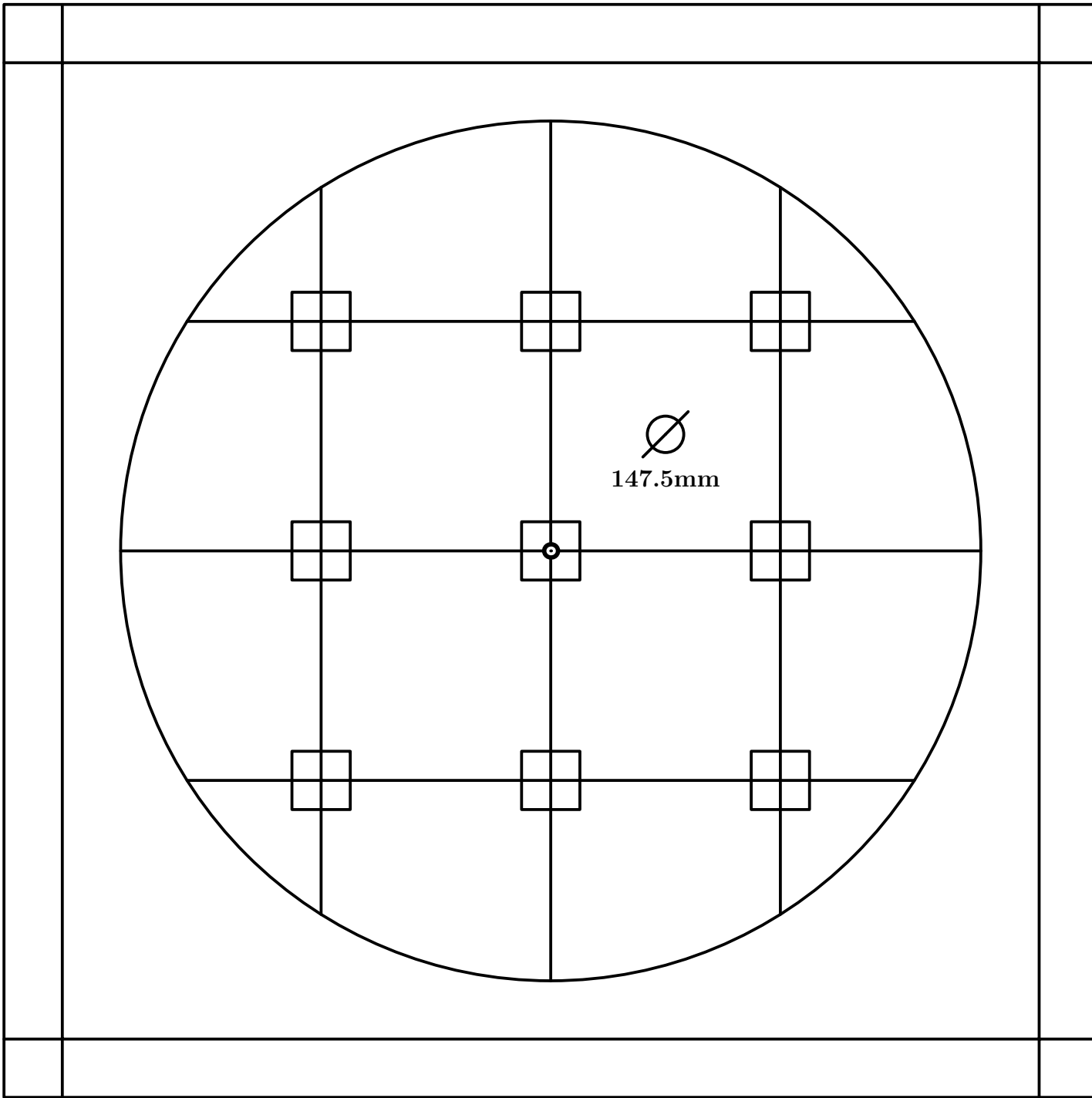

Fig. 191

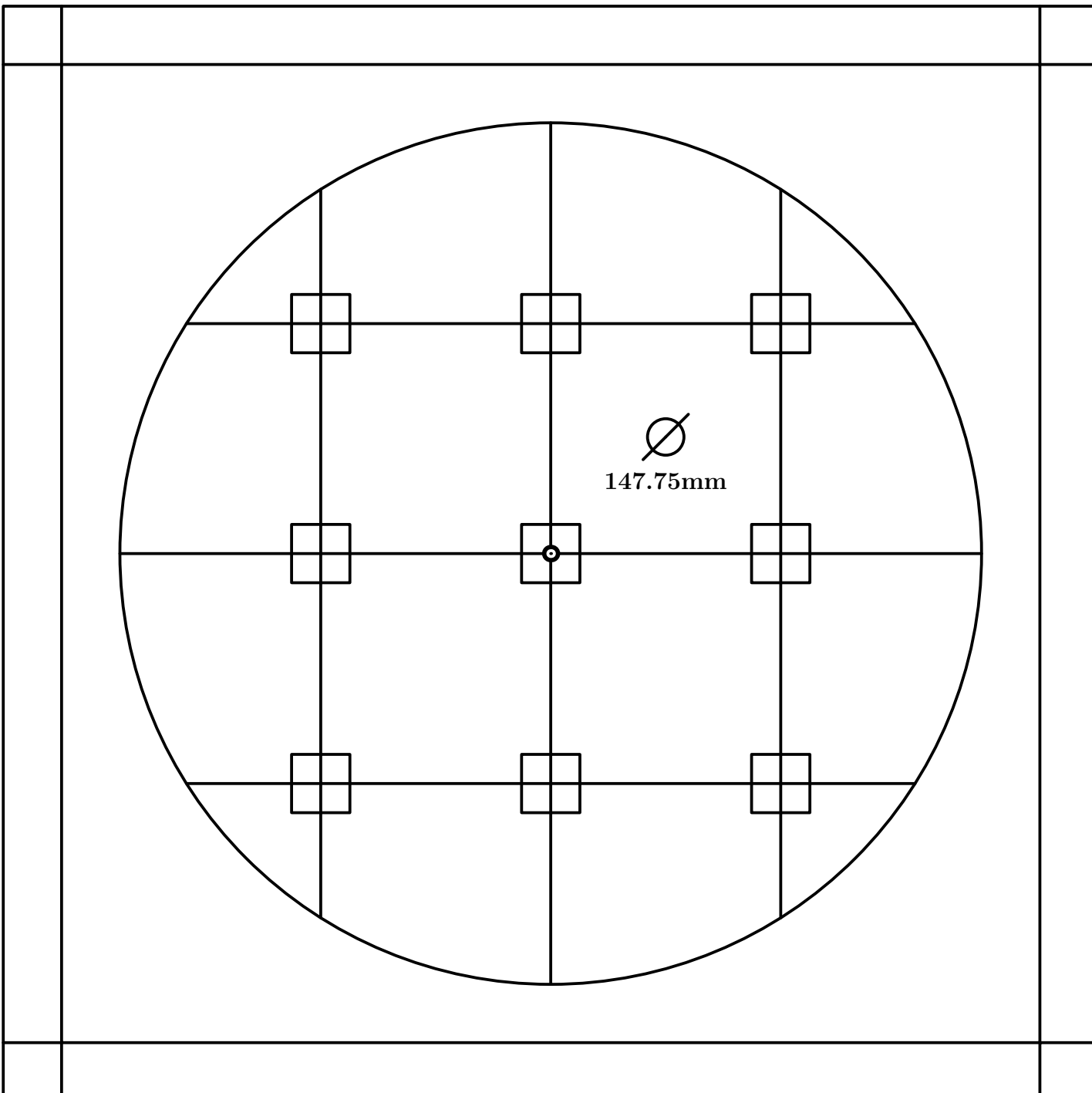

Fig. 192

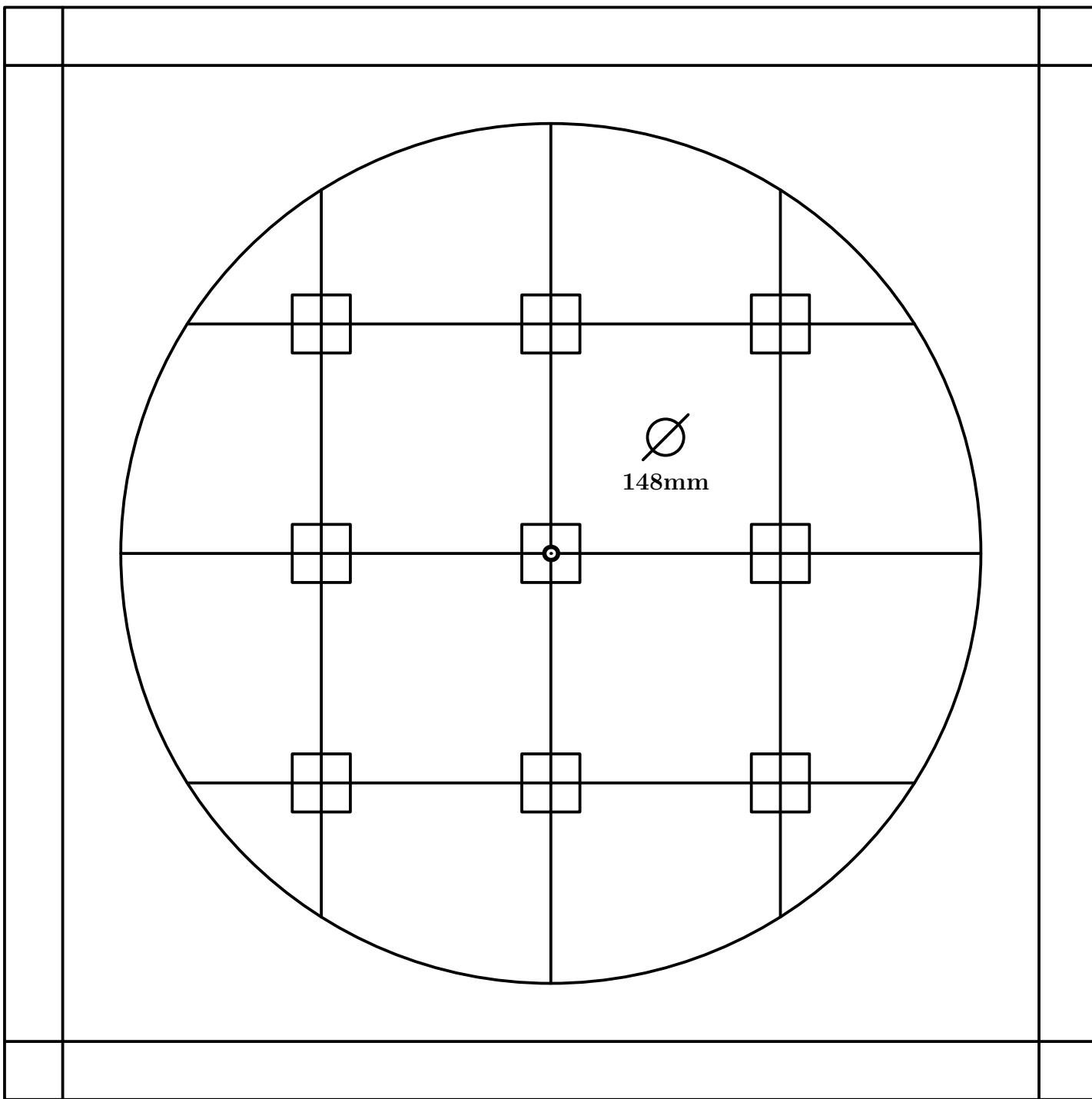

Fig. 193

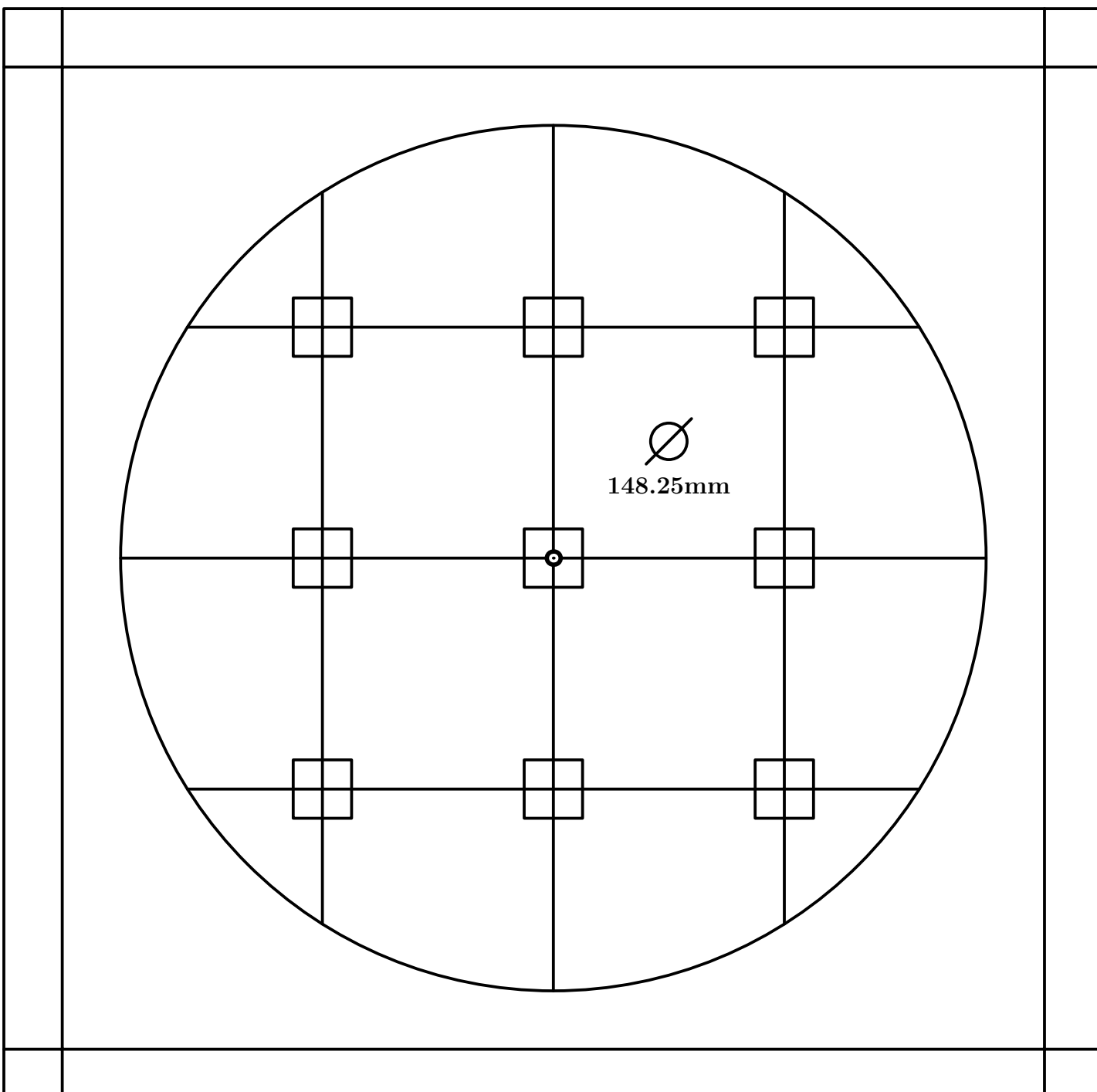

Fig. 194

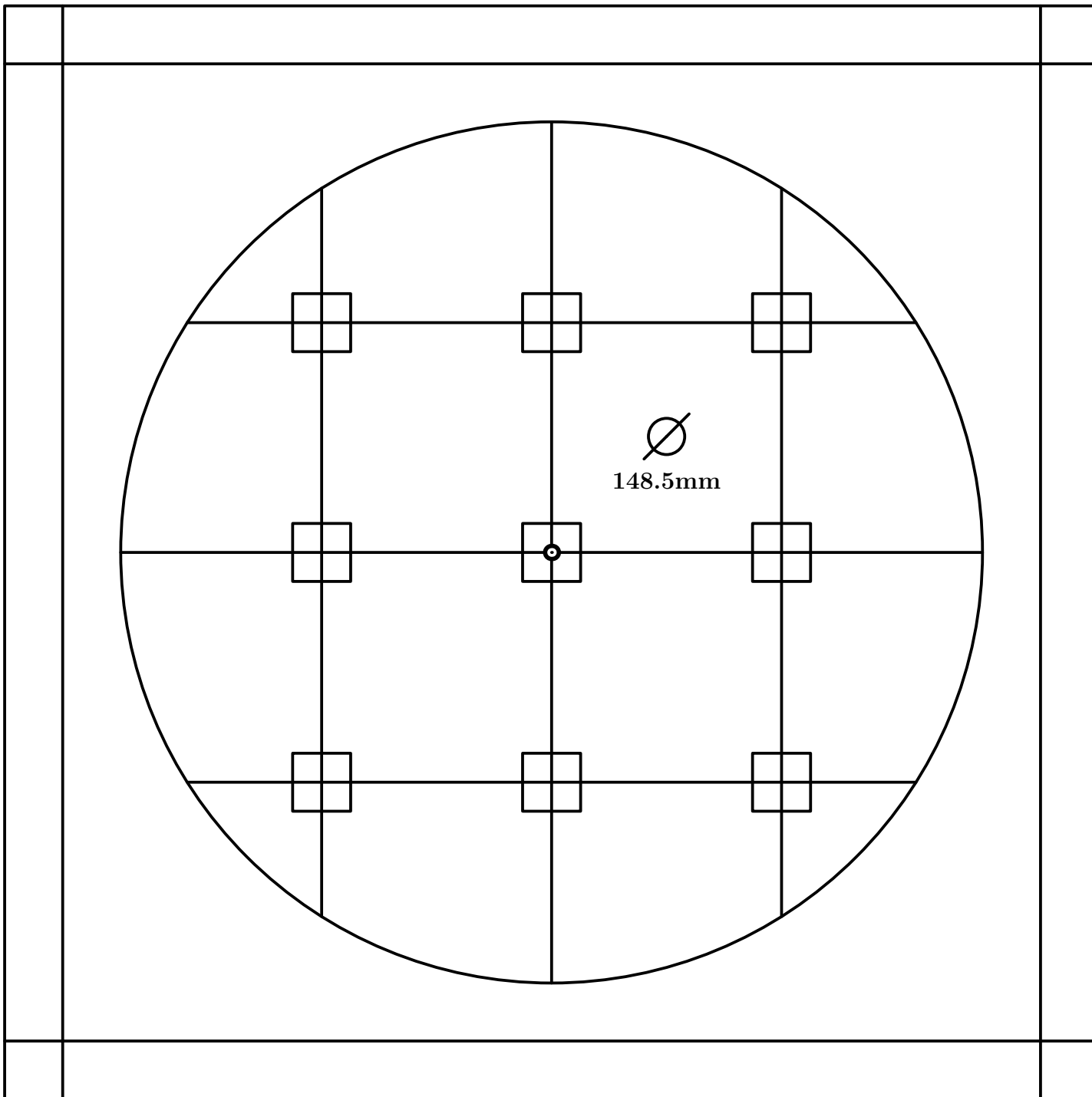

Fig. 195

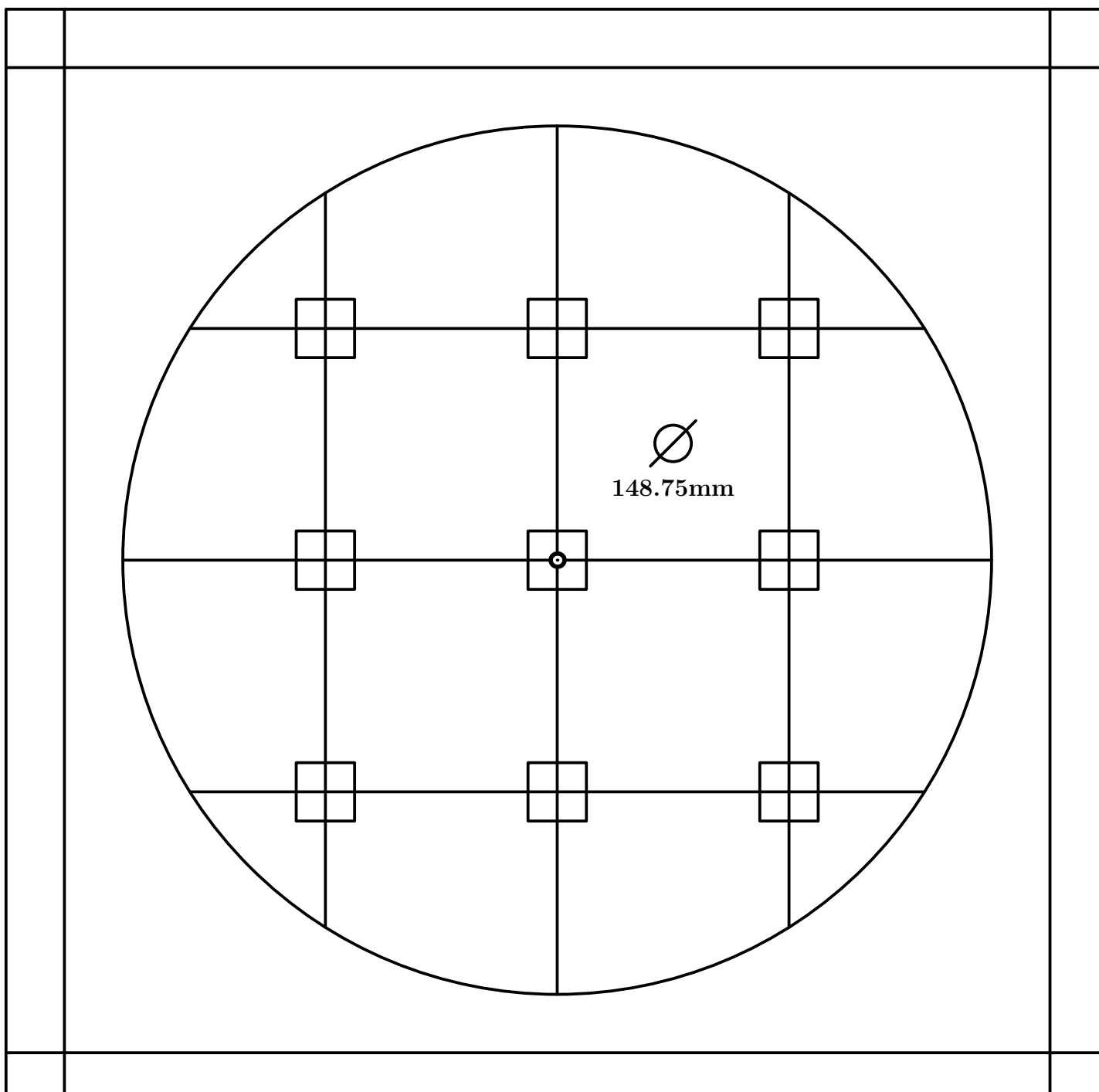

Fig. 196

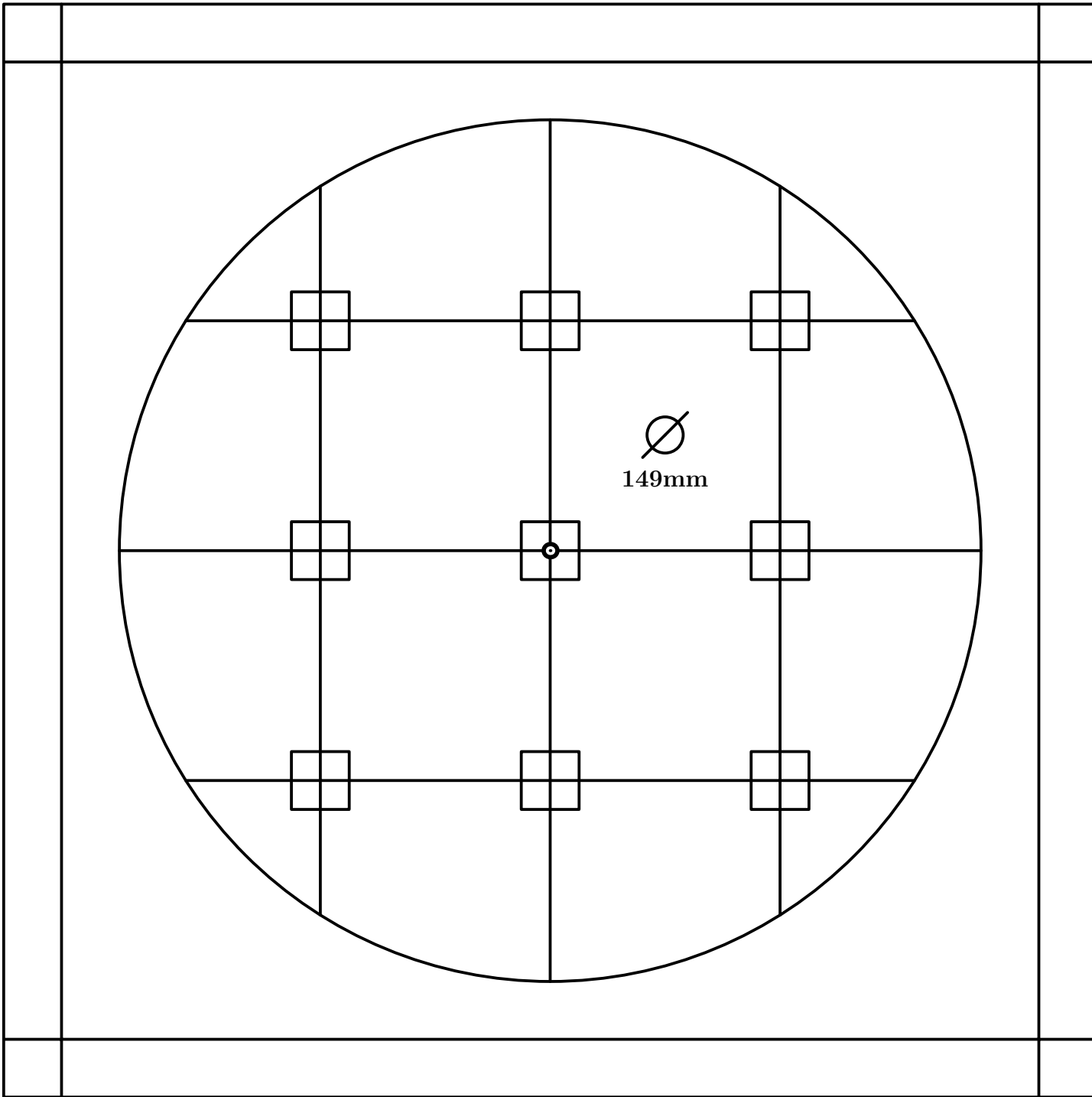

Fig. 197

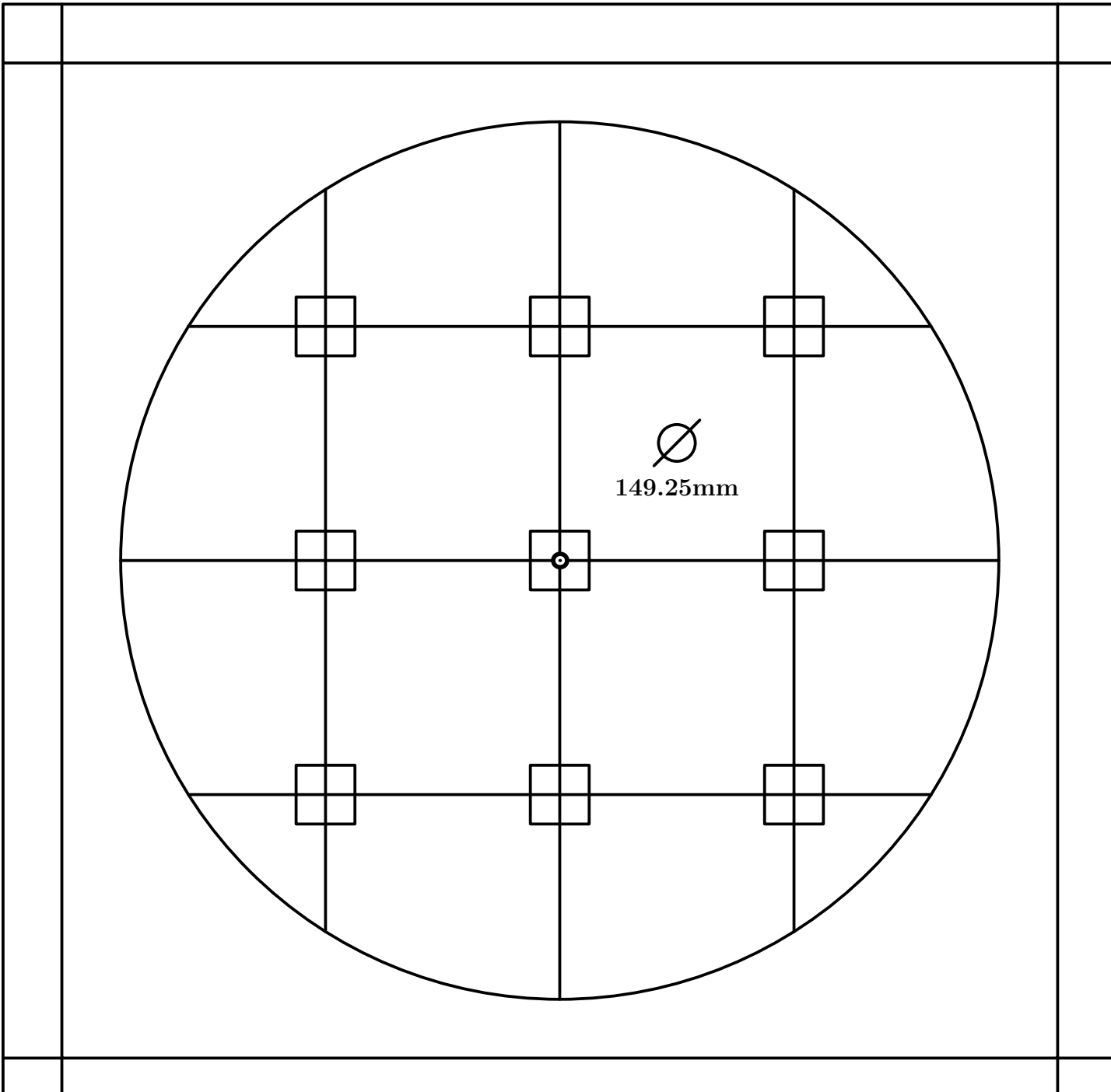

Fig. 198

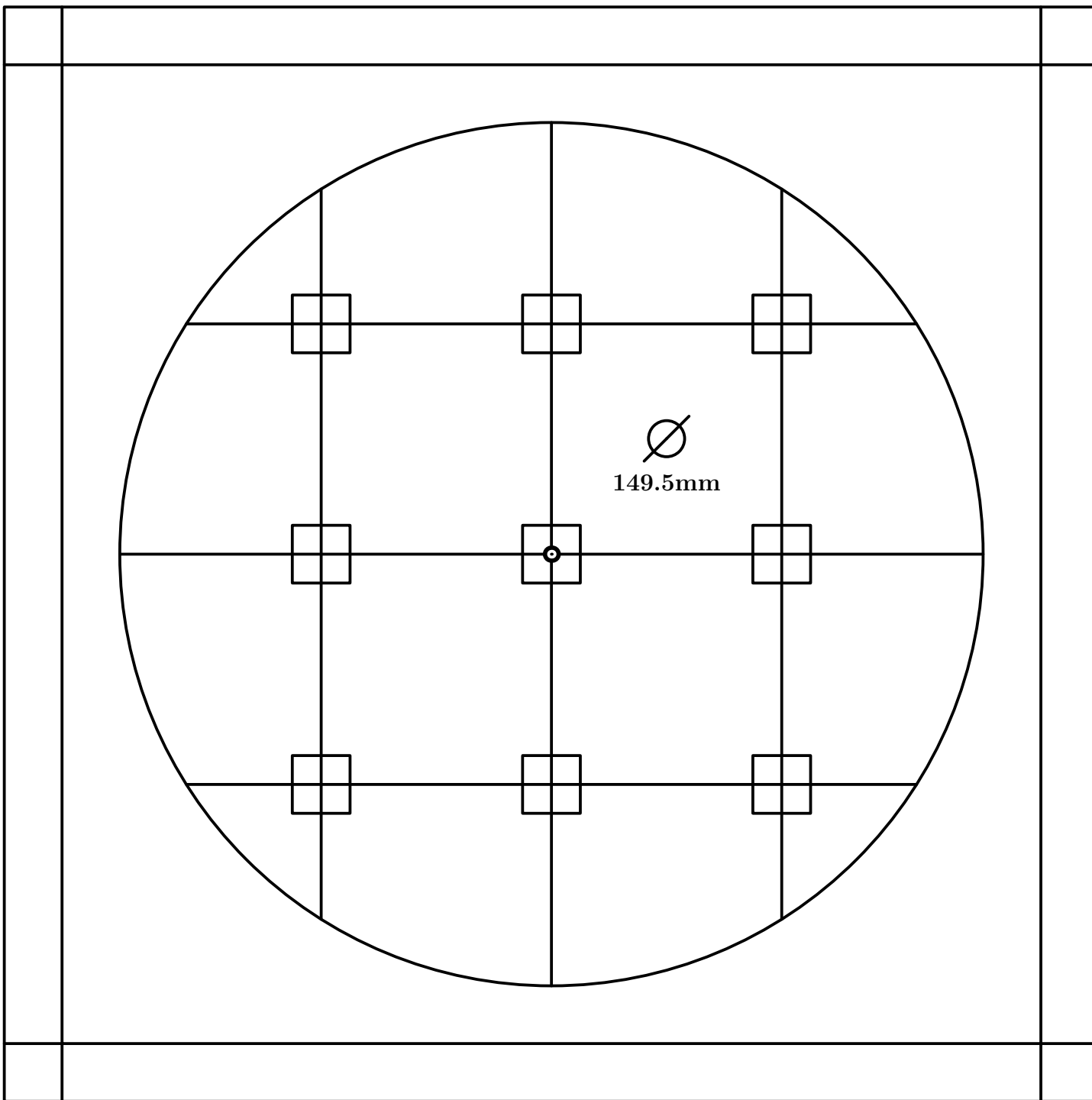

Fig. 199

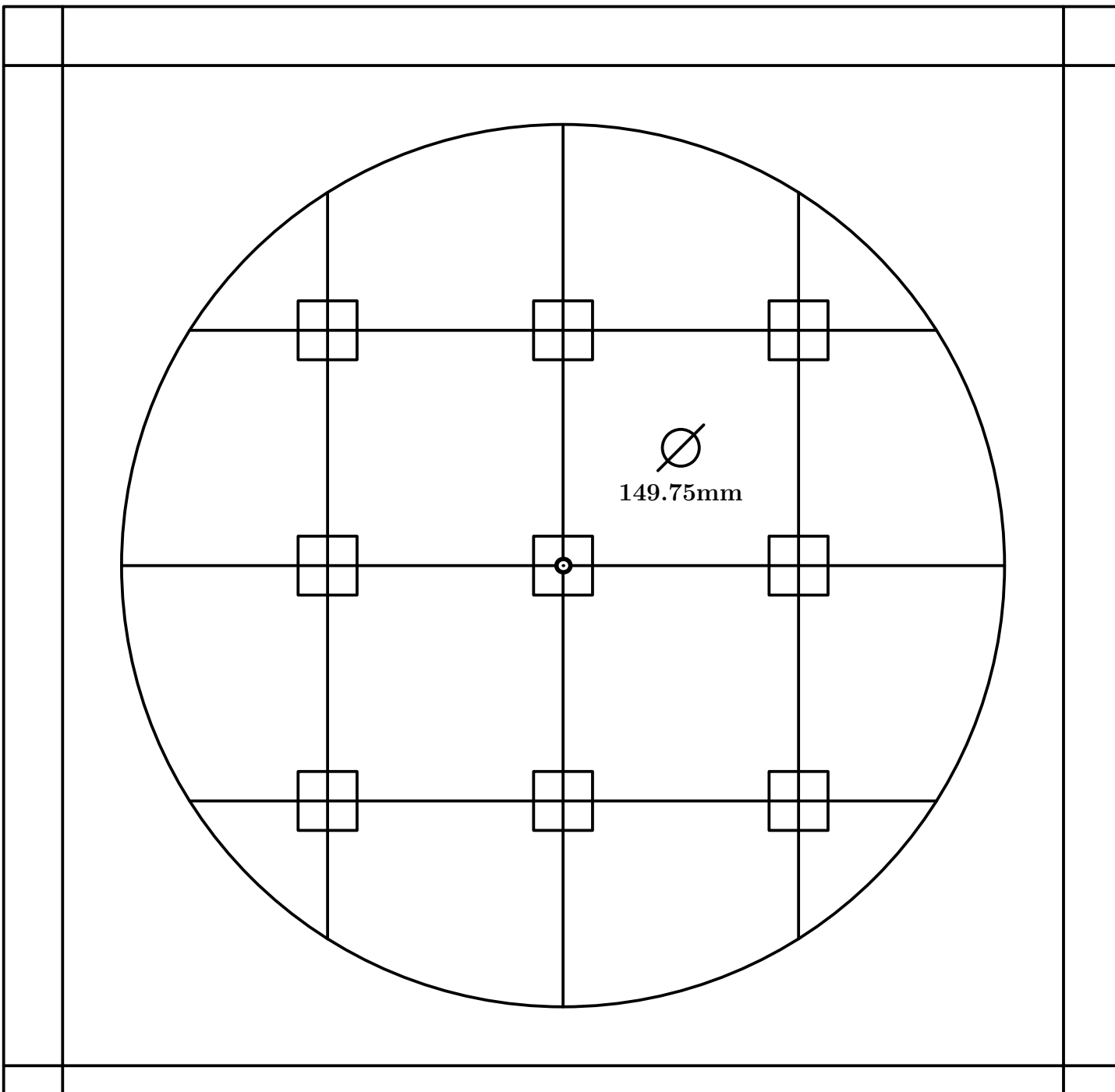

Fig. 200

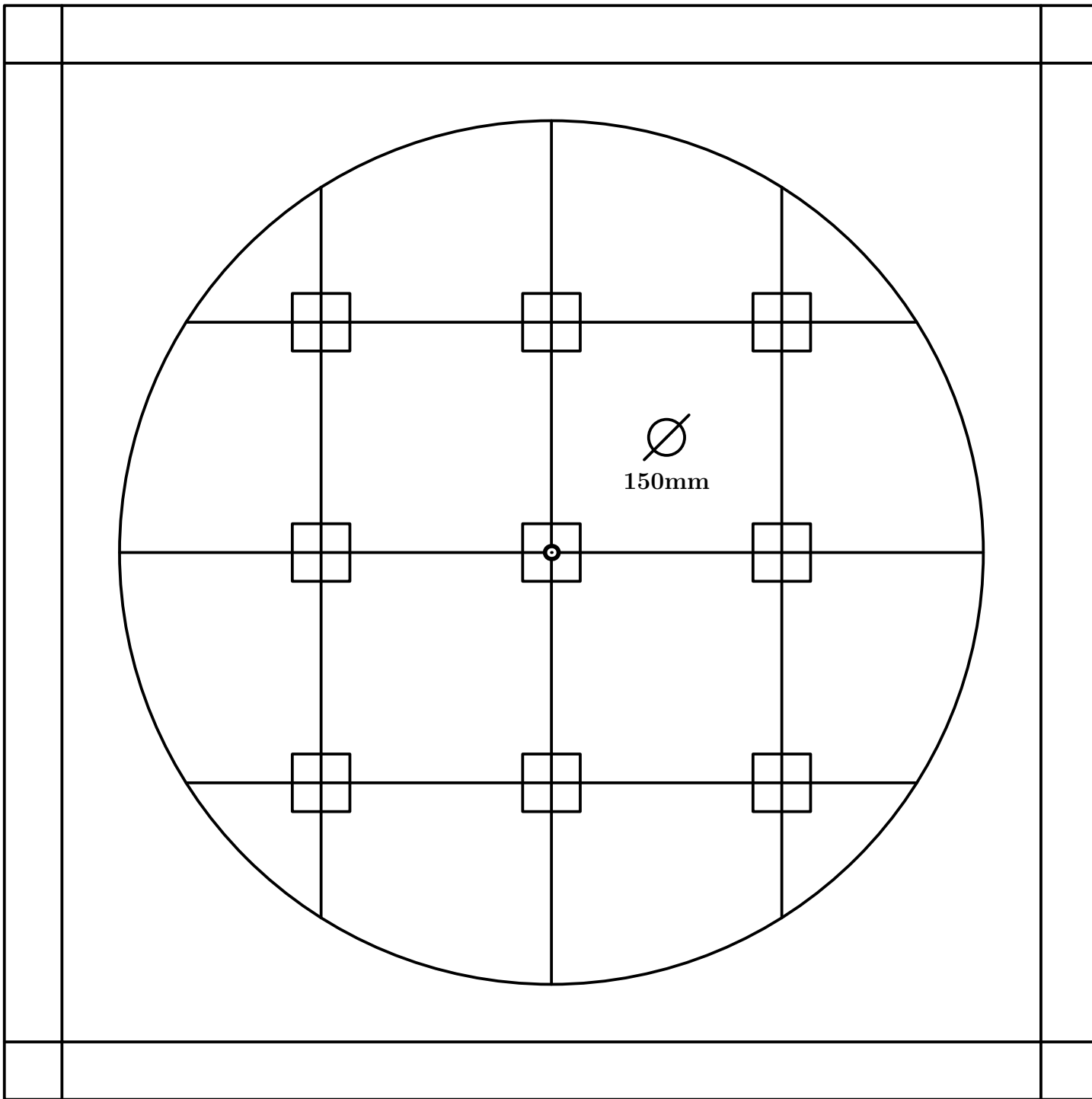

Fig. 201

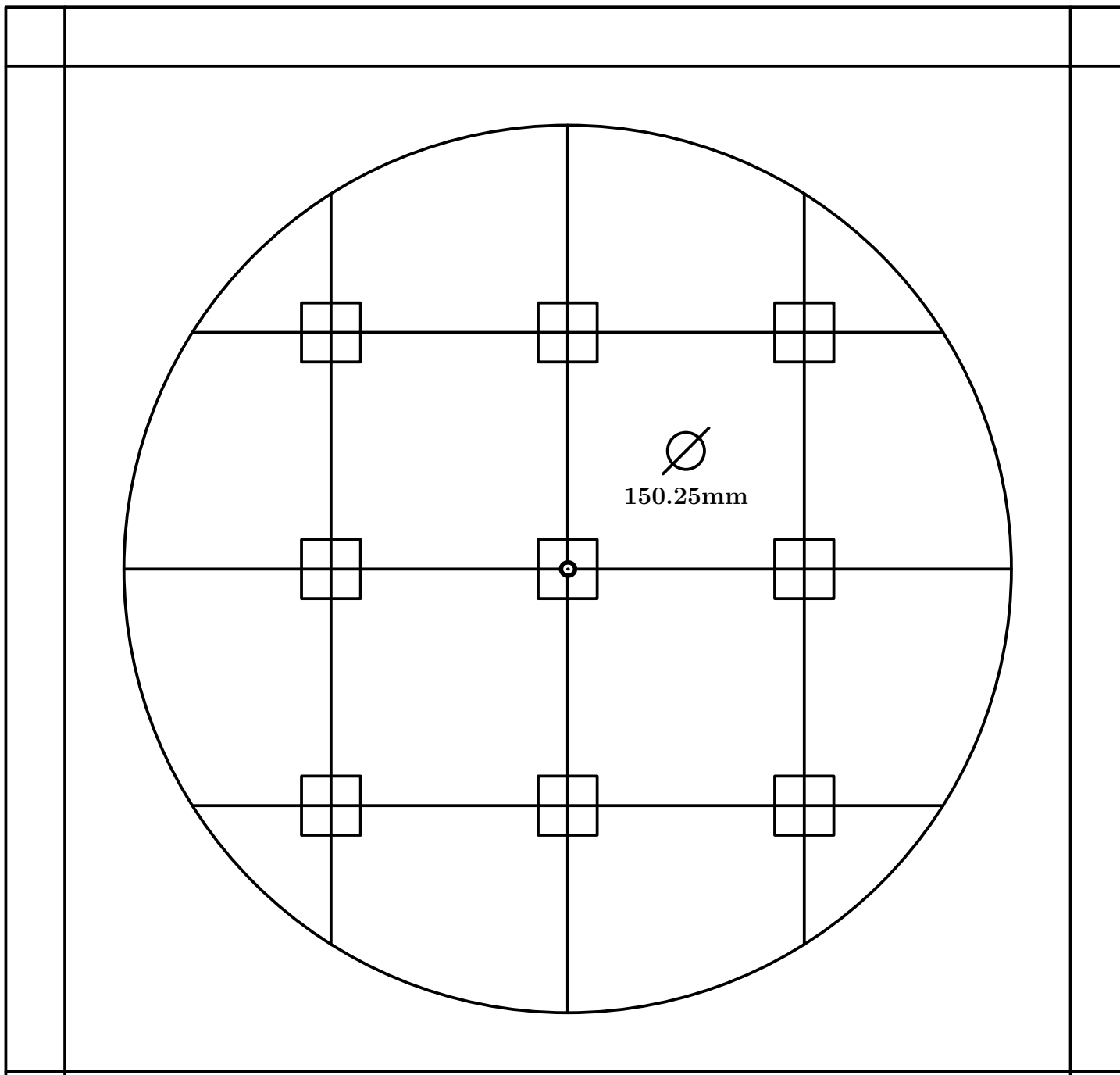

Fig. 202

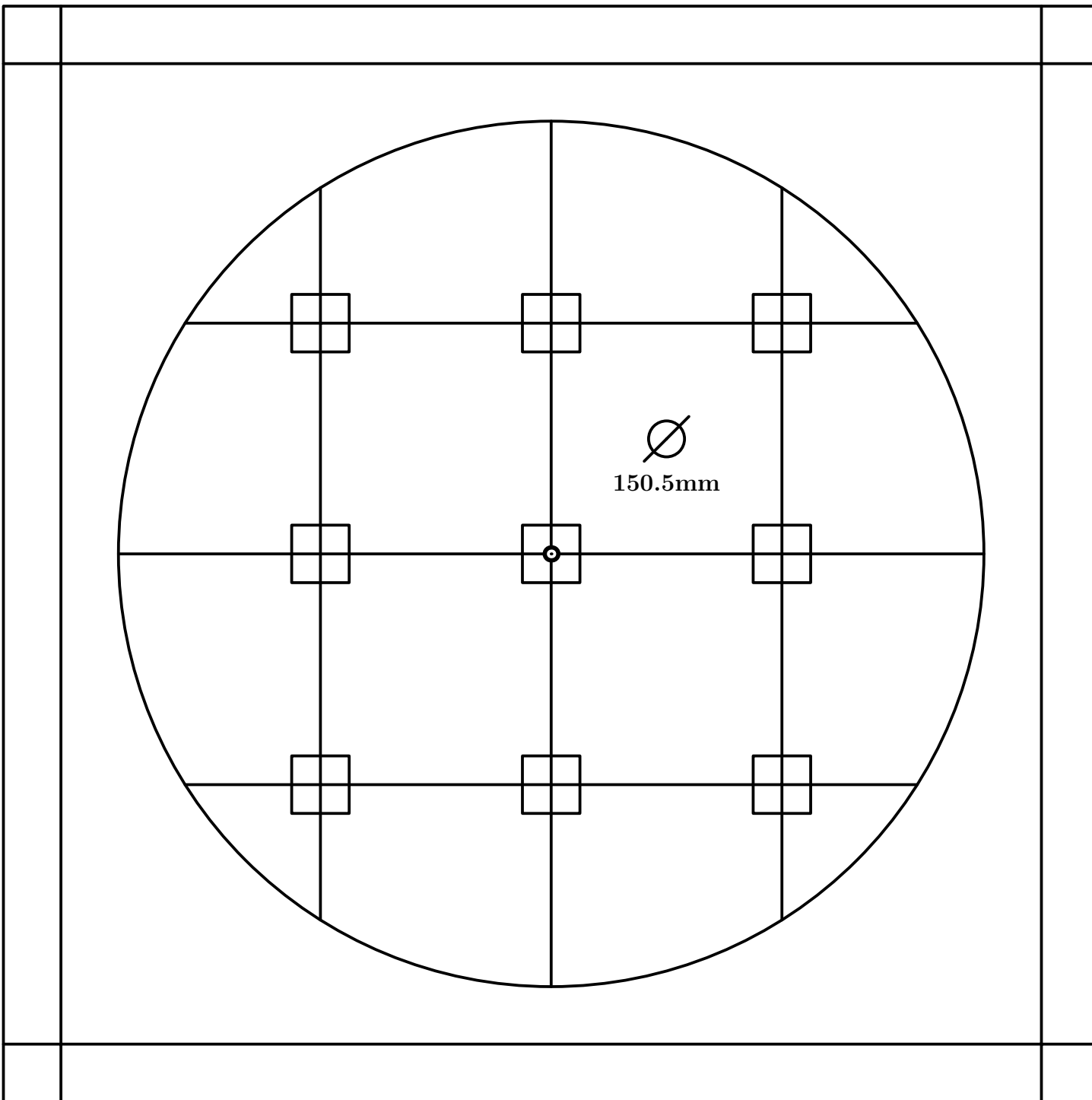

Fig. 203

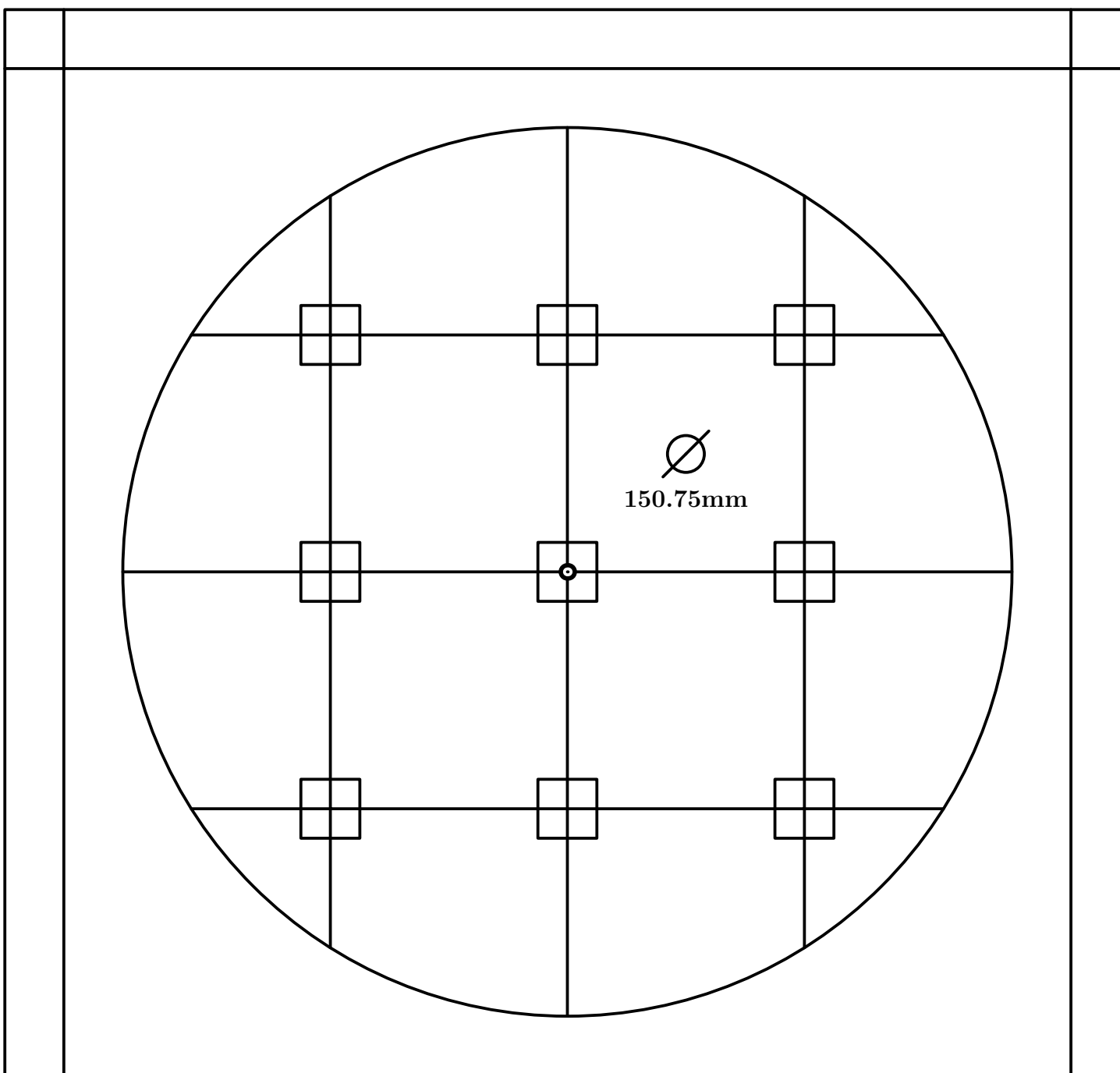

Fig. 204

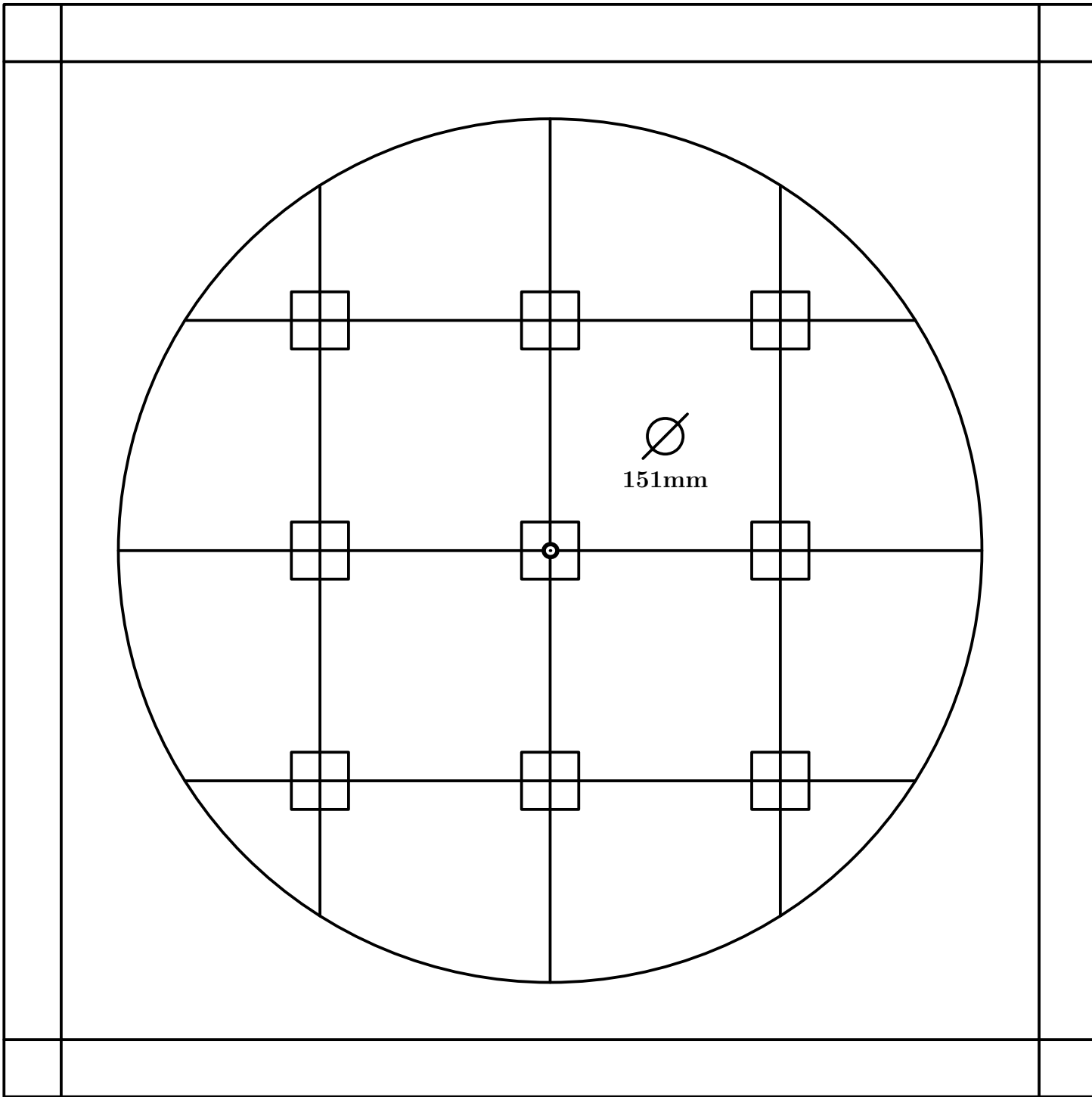

Fig. 205

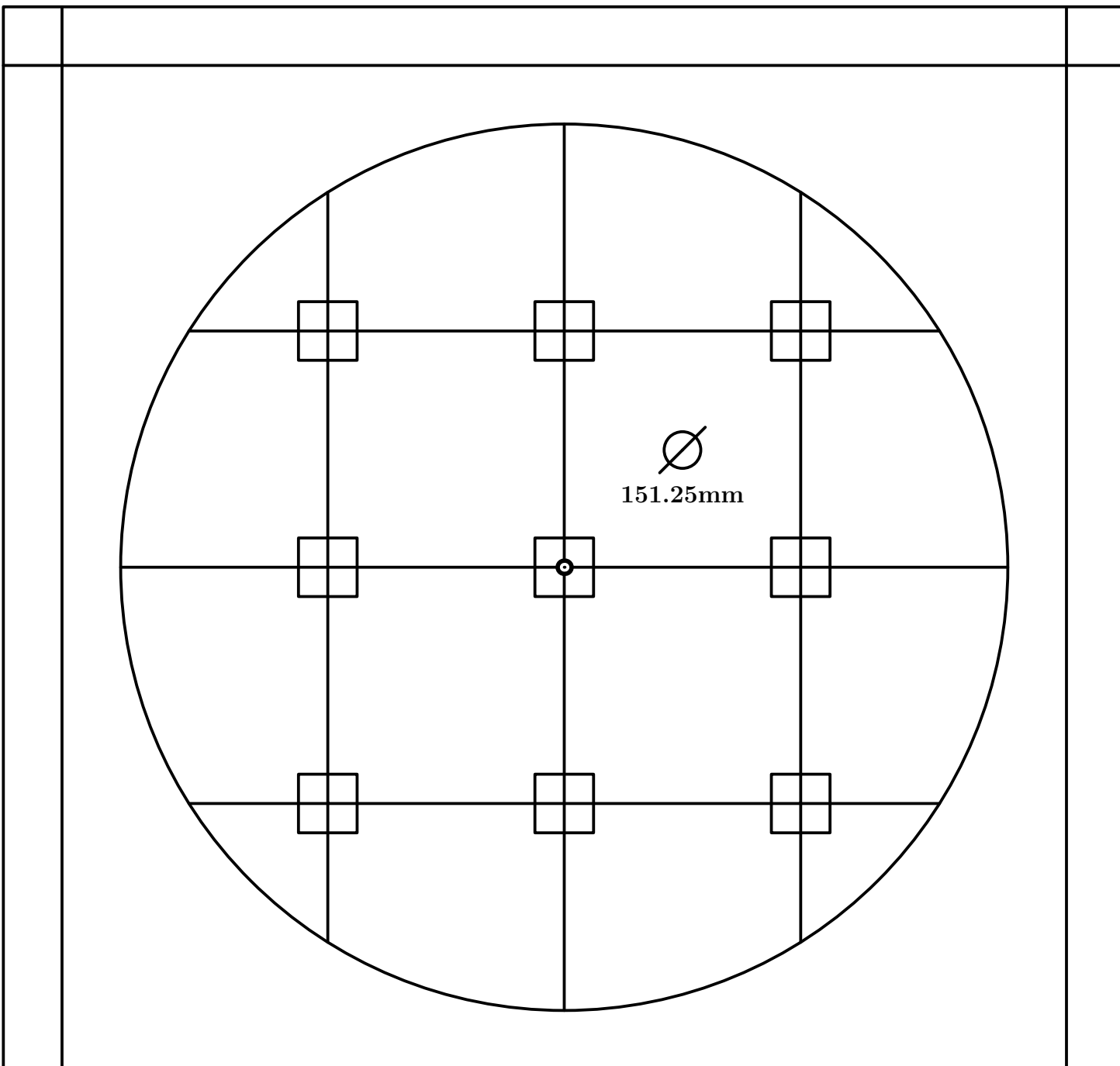

Fig. 206

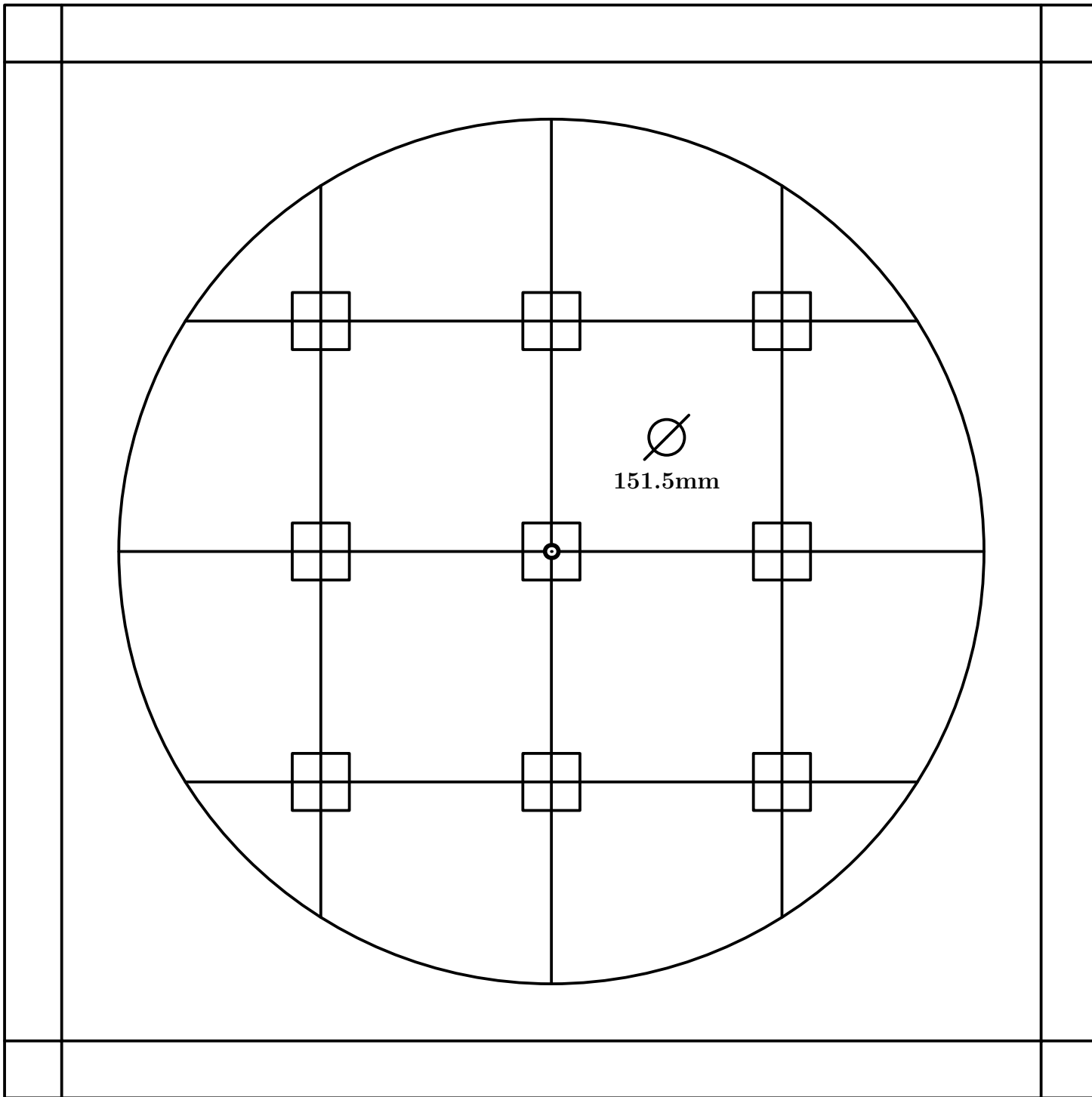

Fig. 207

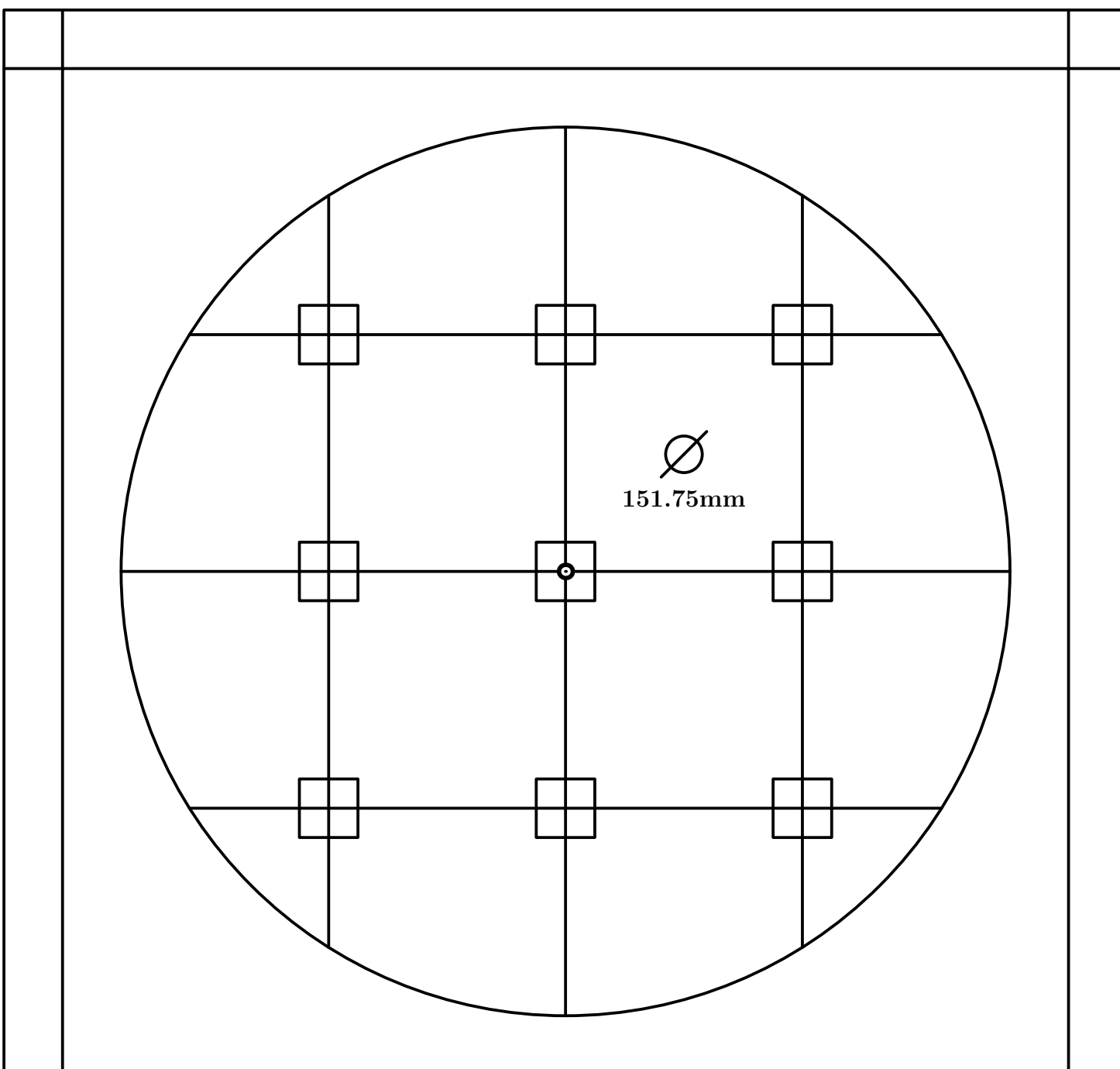

Fig. 208

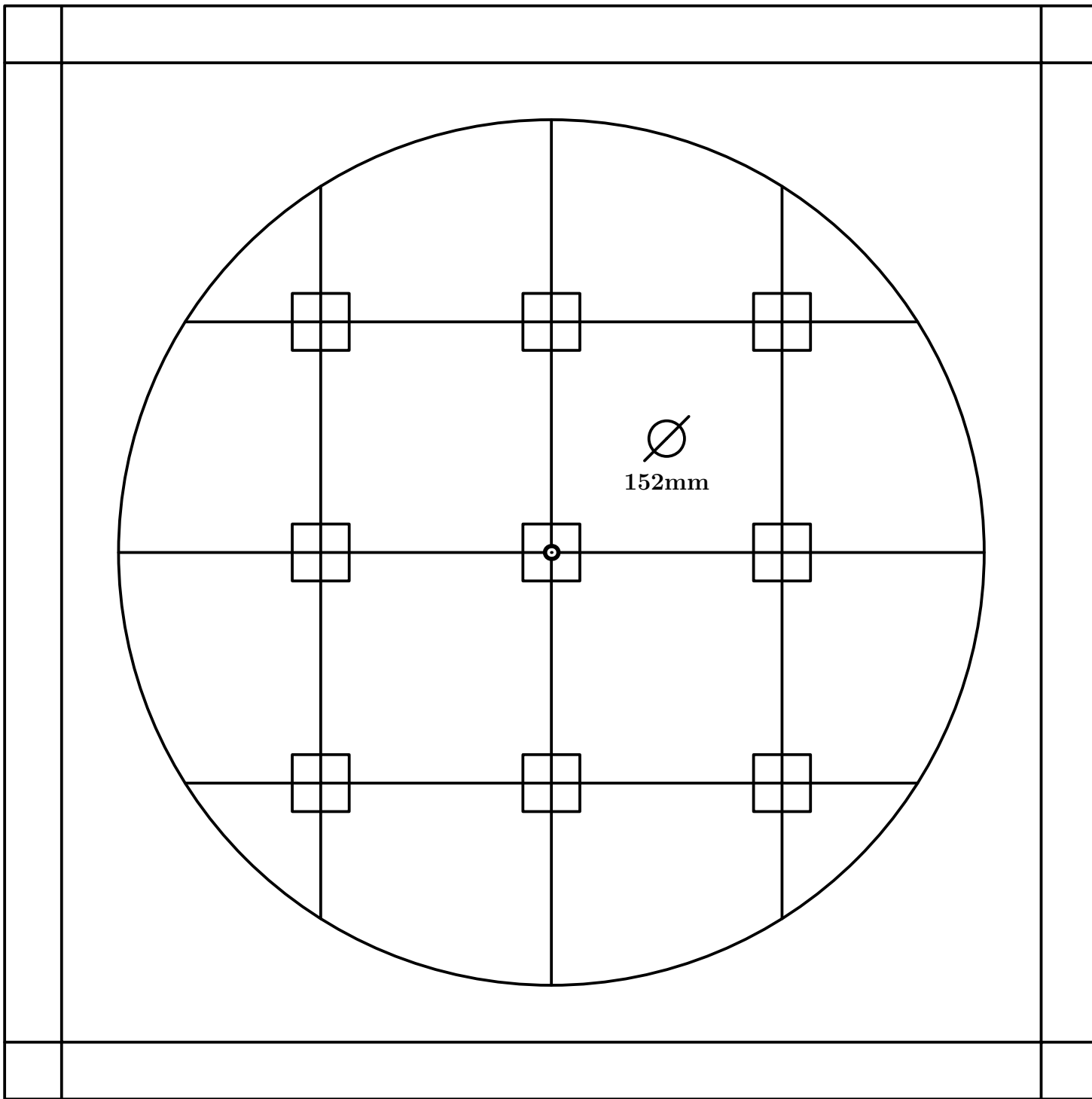

Fig. 209

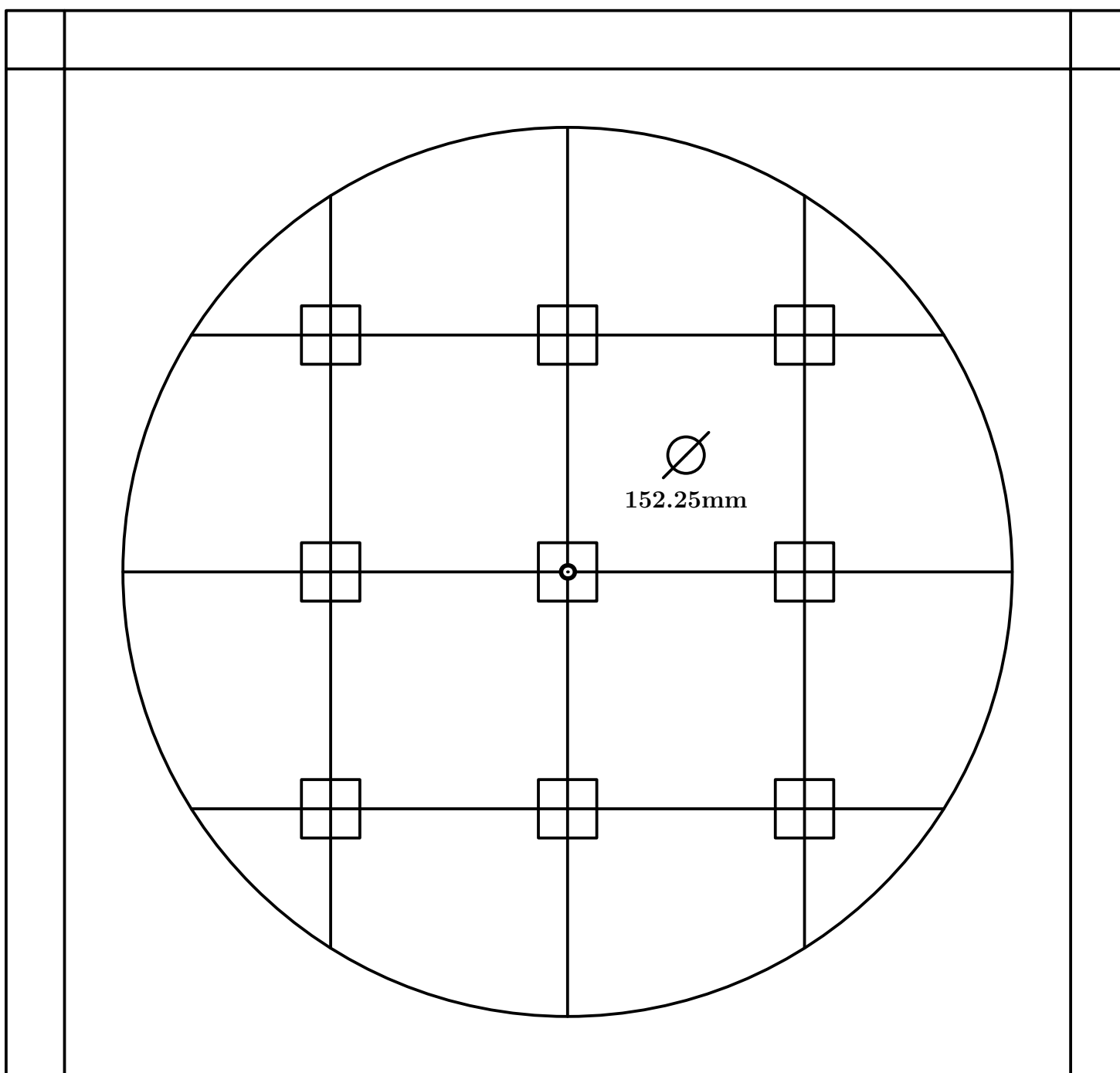

Fig. 210

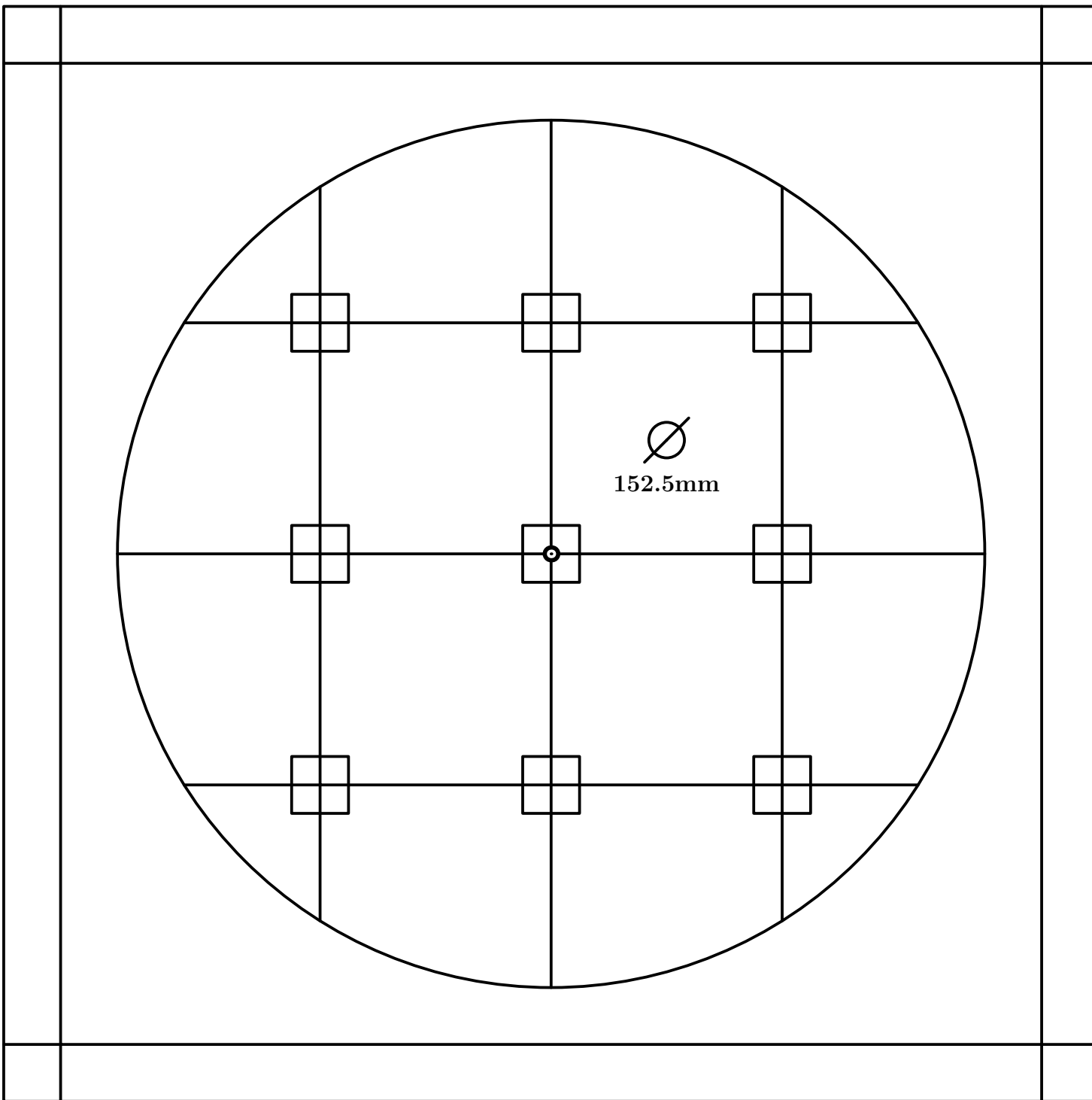

Fig. 211

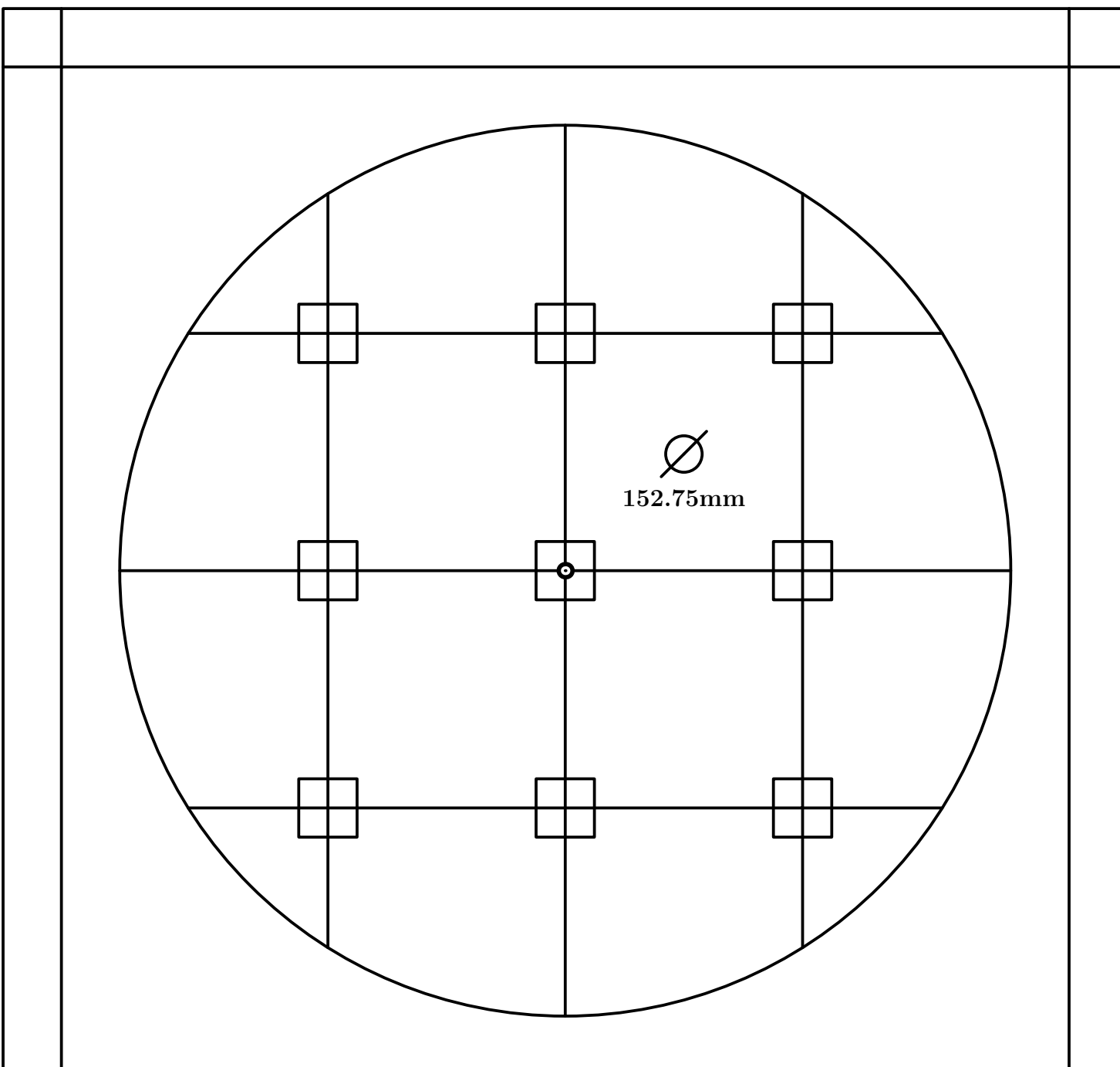

Fig. 212

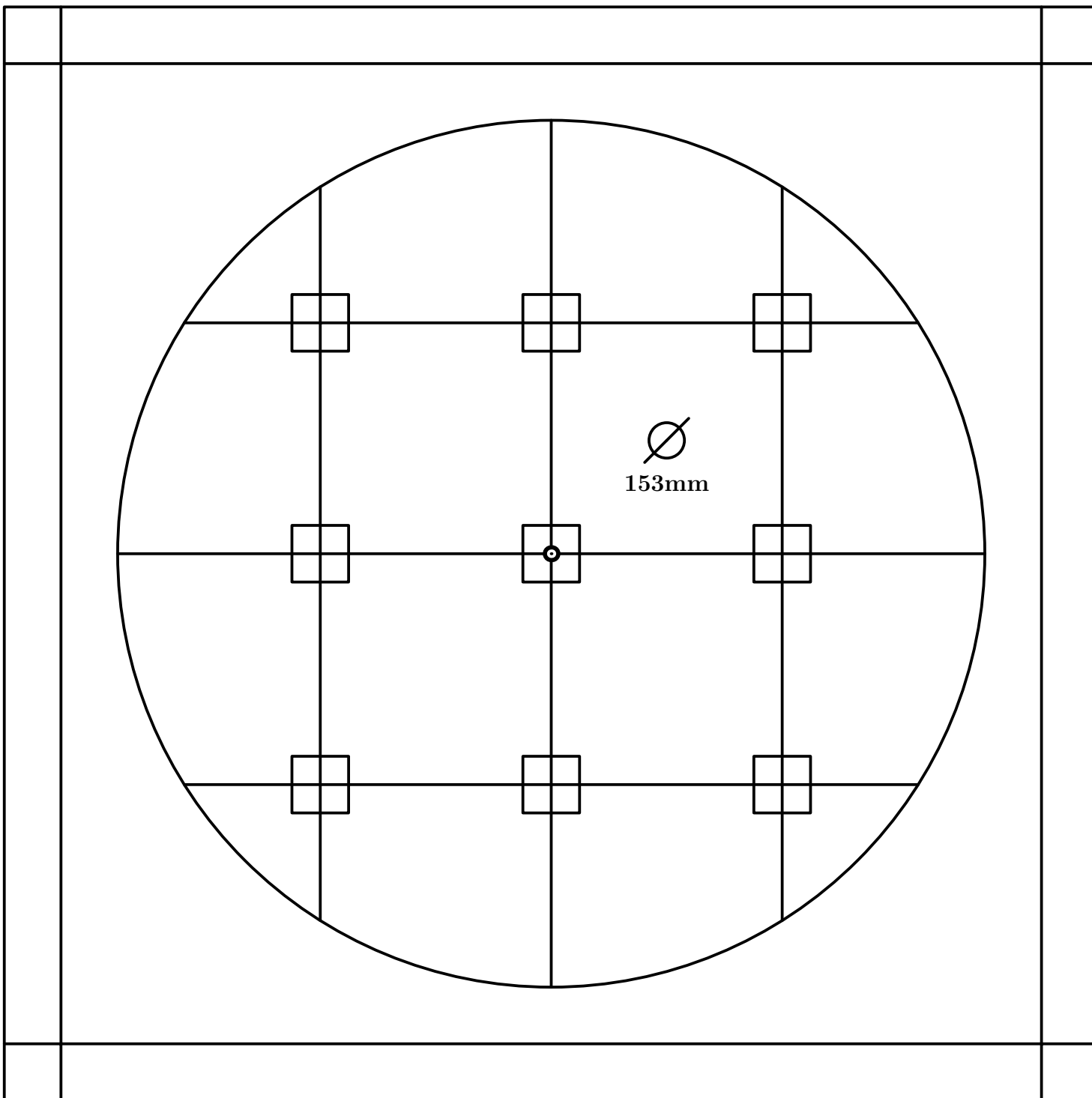

Fig. 213

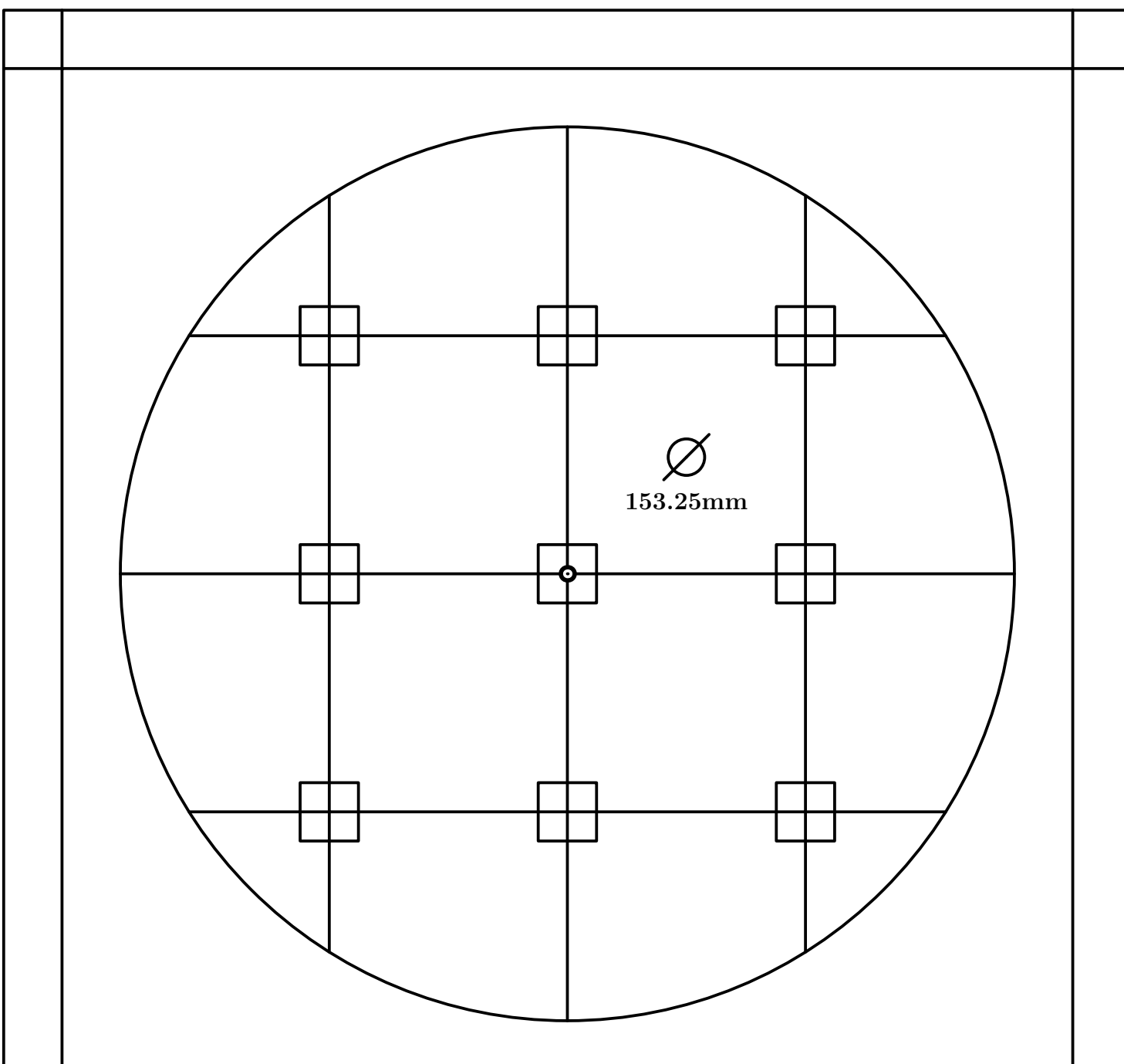

Fig. 214

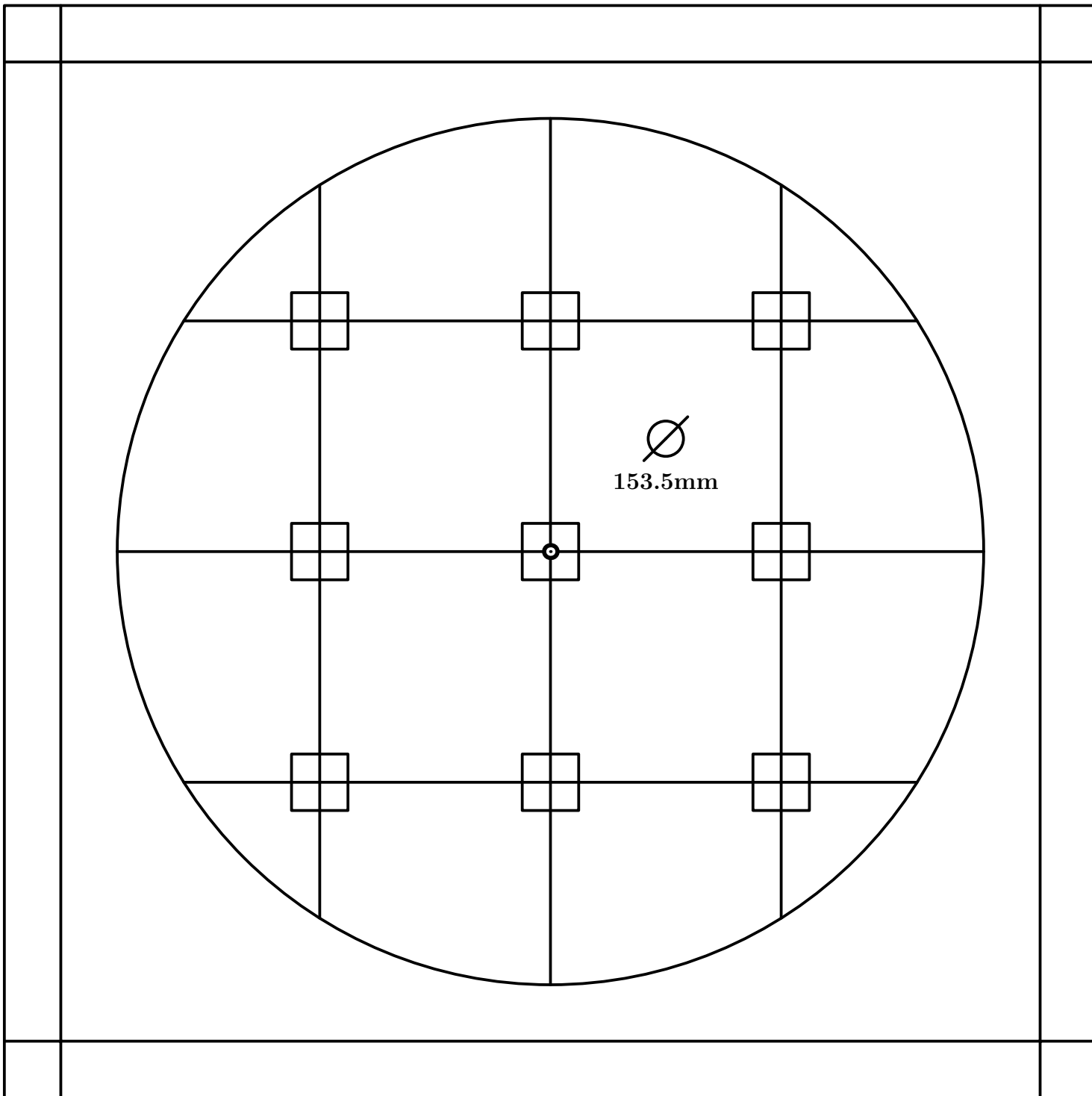

Fig. 215

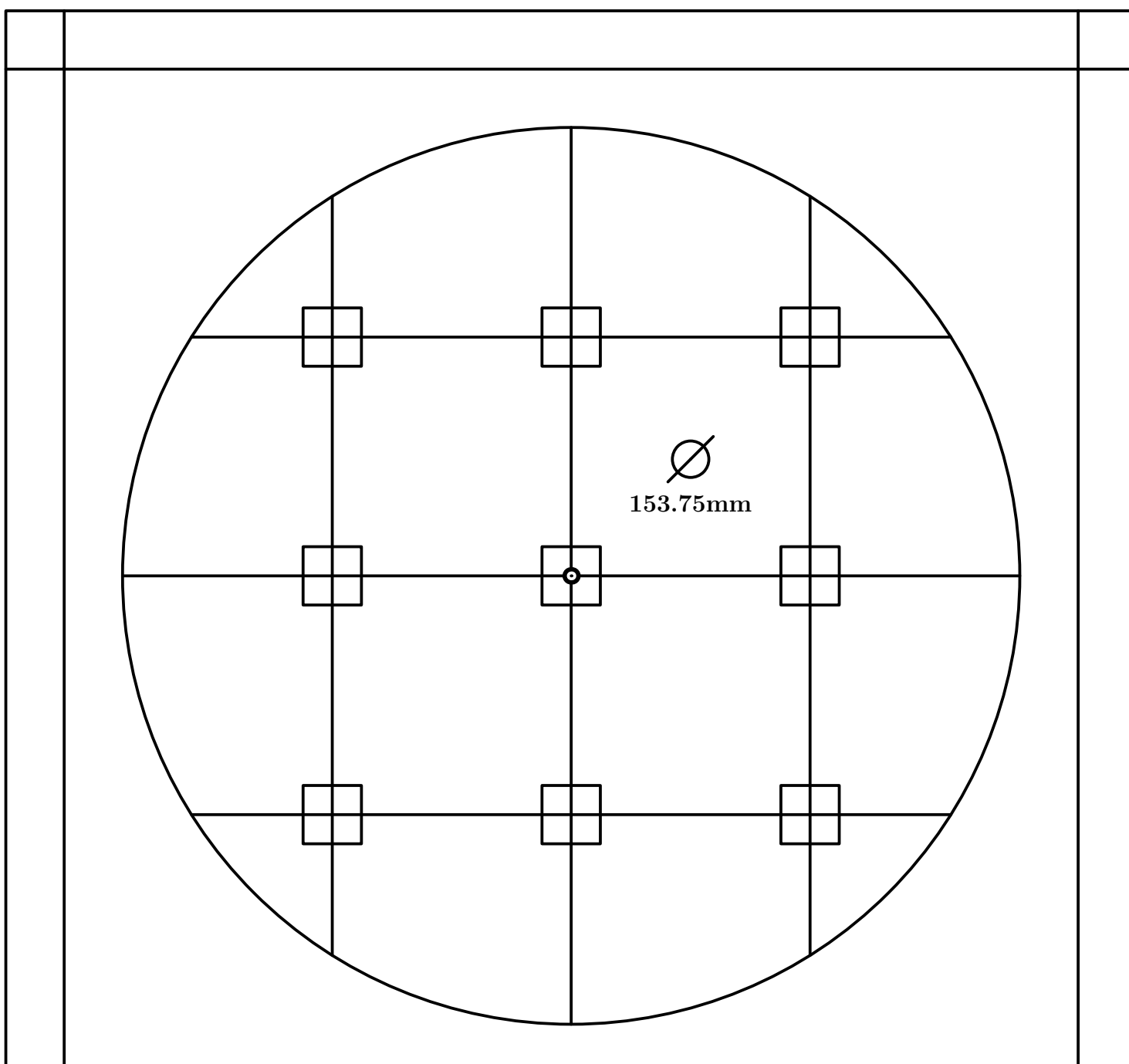

Fig. 216

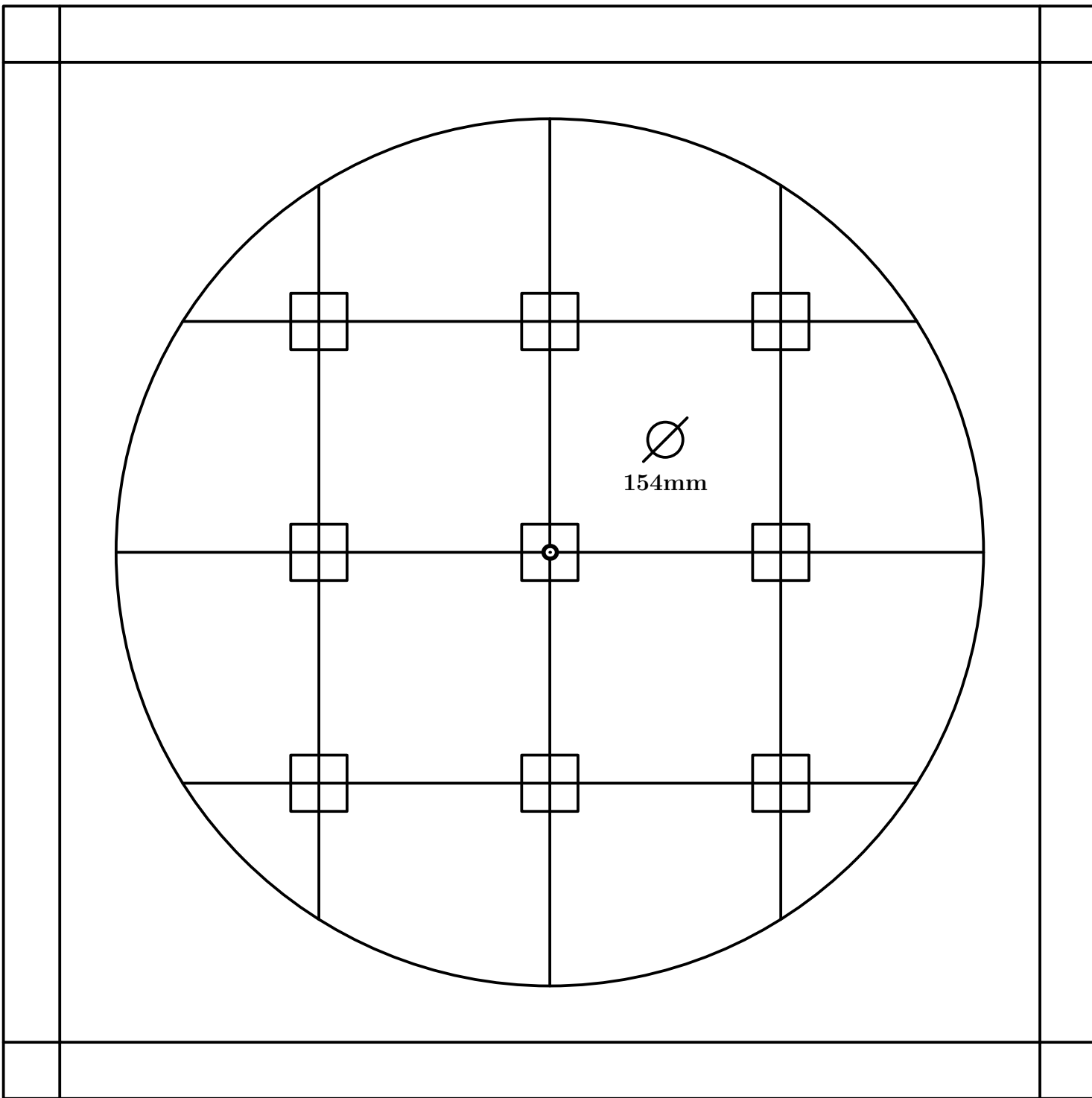

Fig. 217

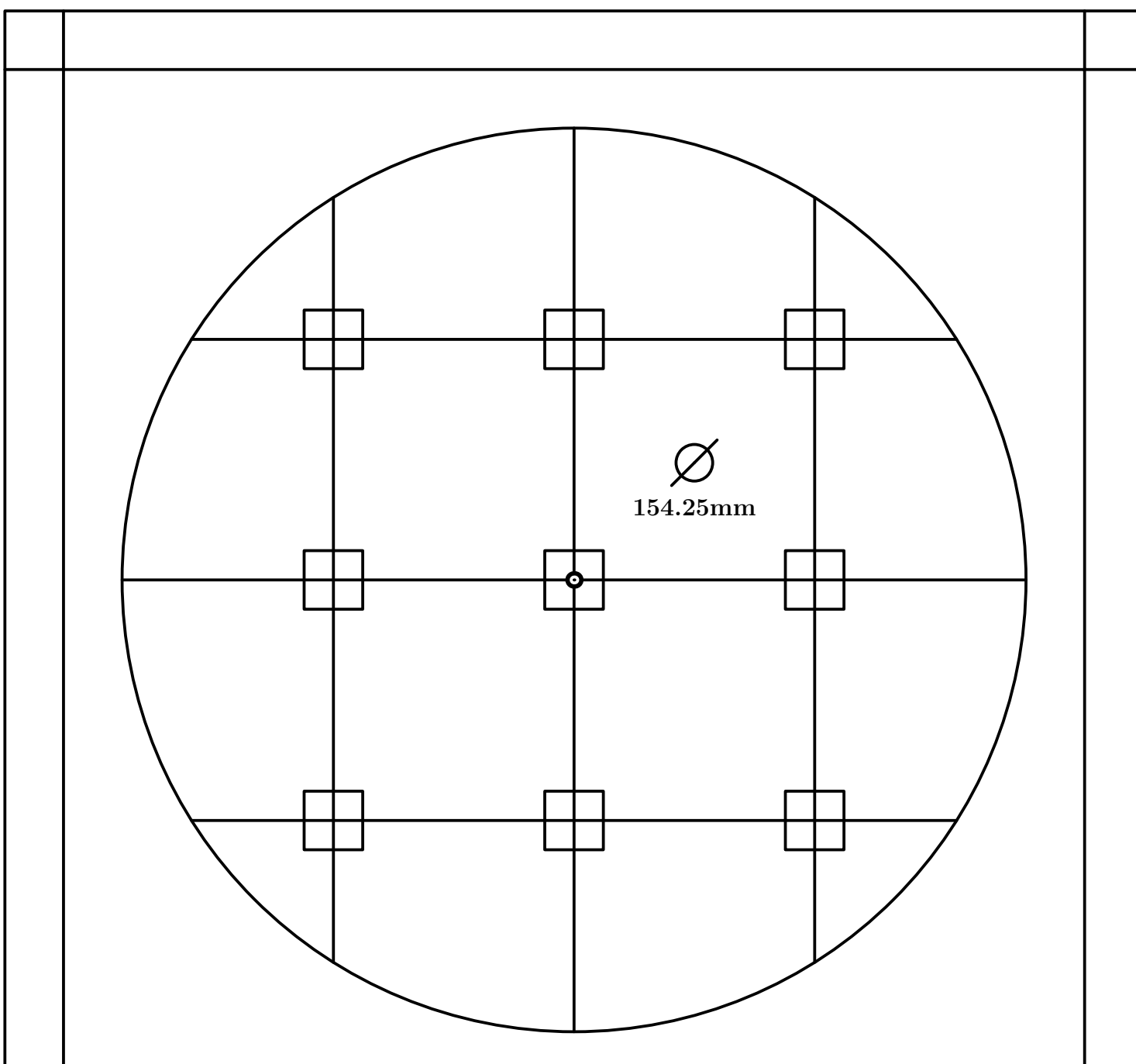

Fig. 218

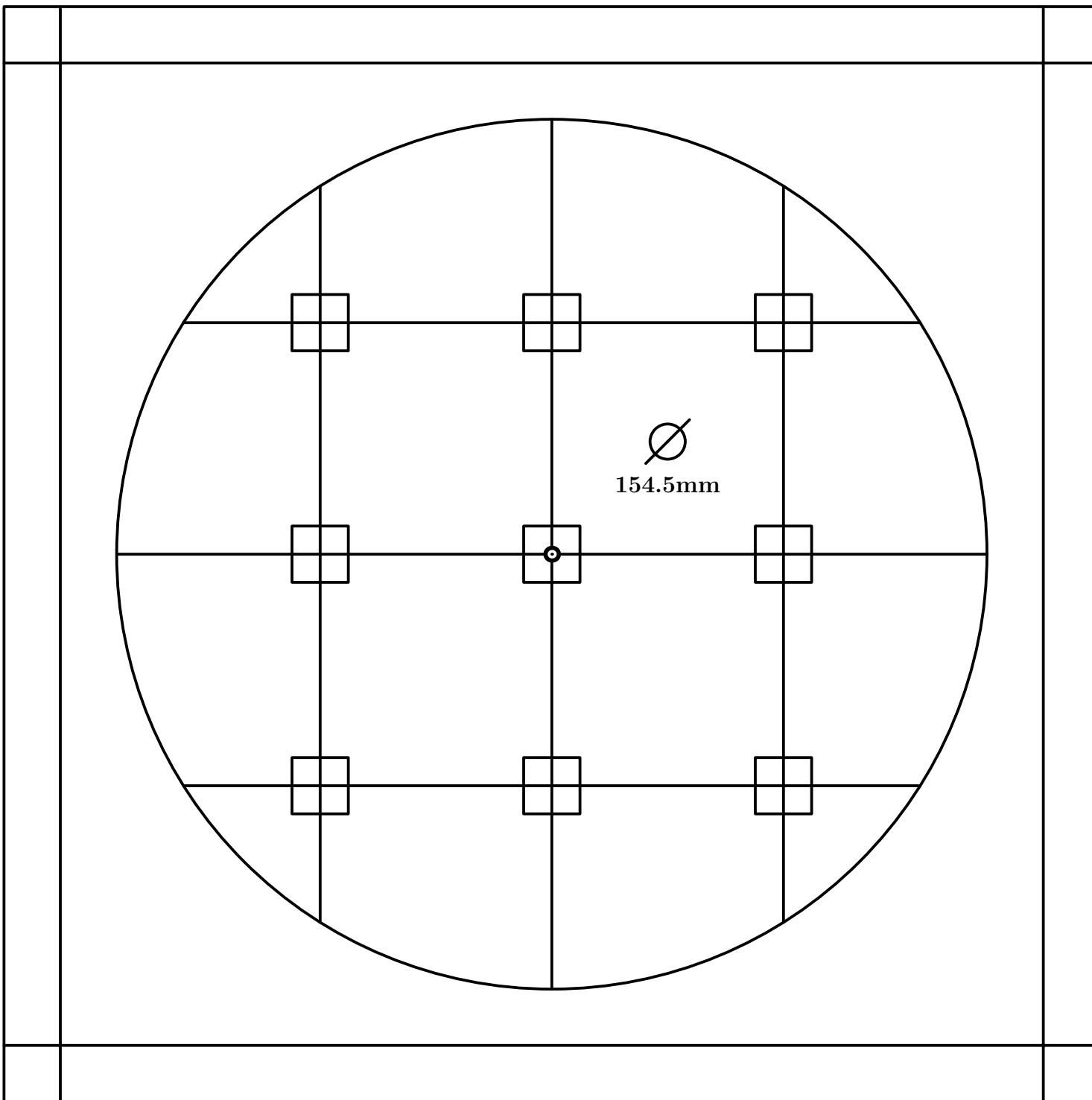

Fig. 219

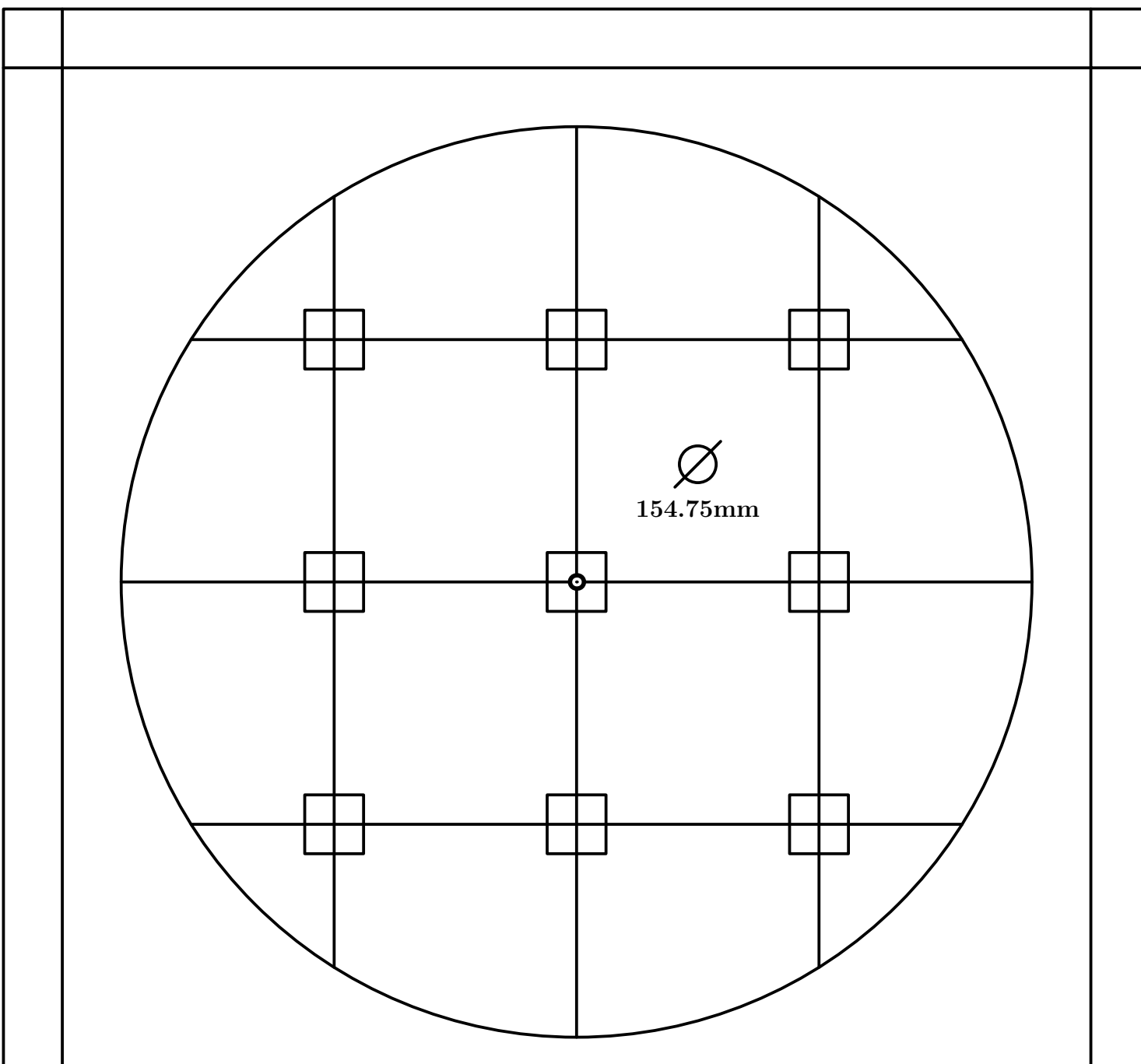

Fig. 220

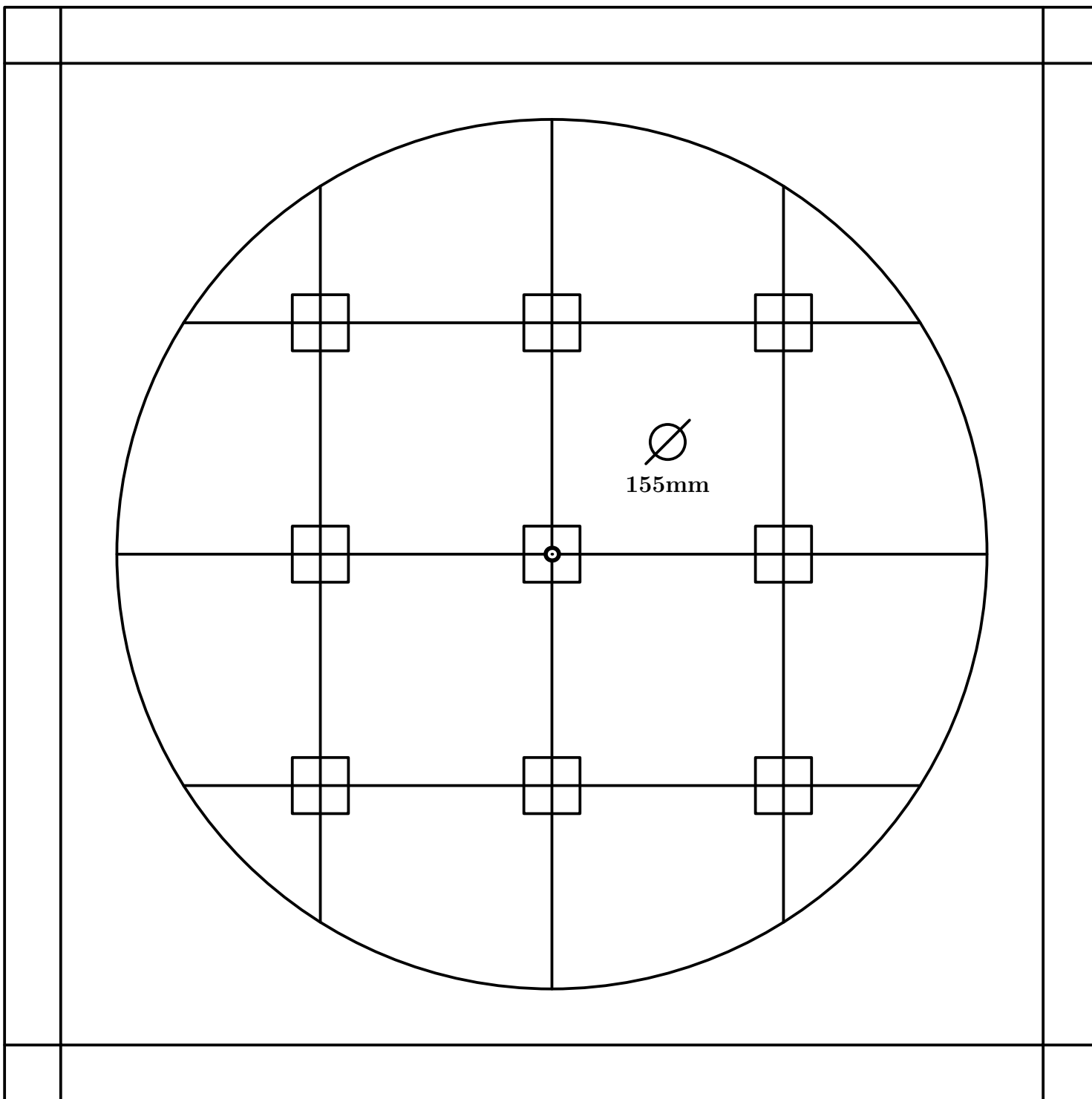

Fig. 221

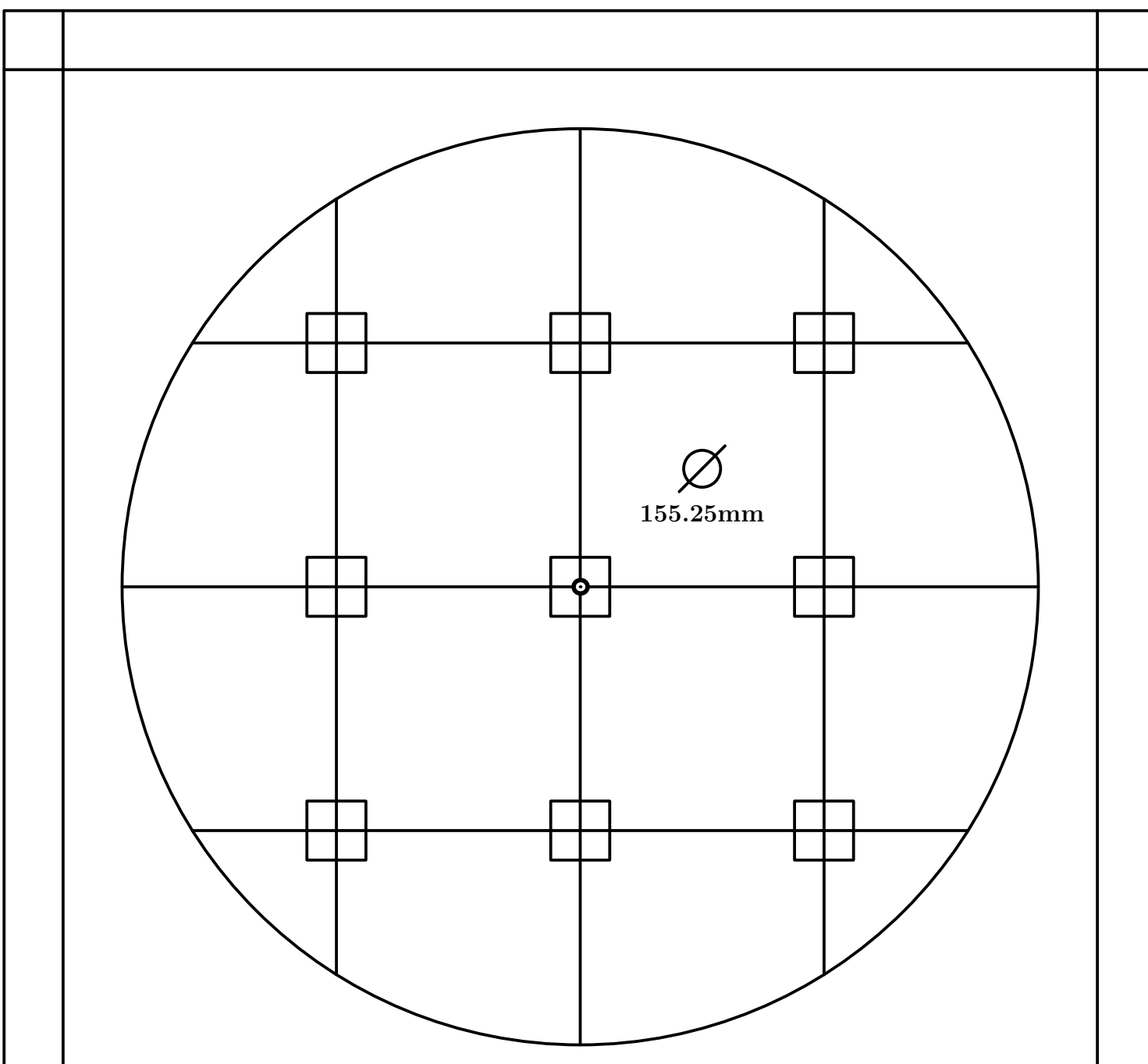

Fig. 222

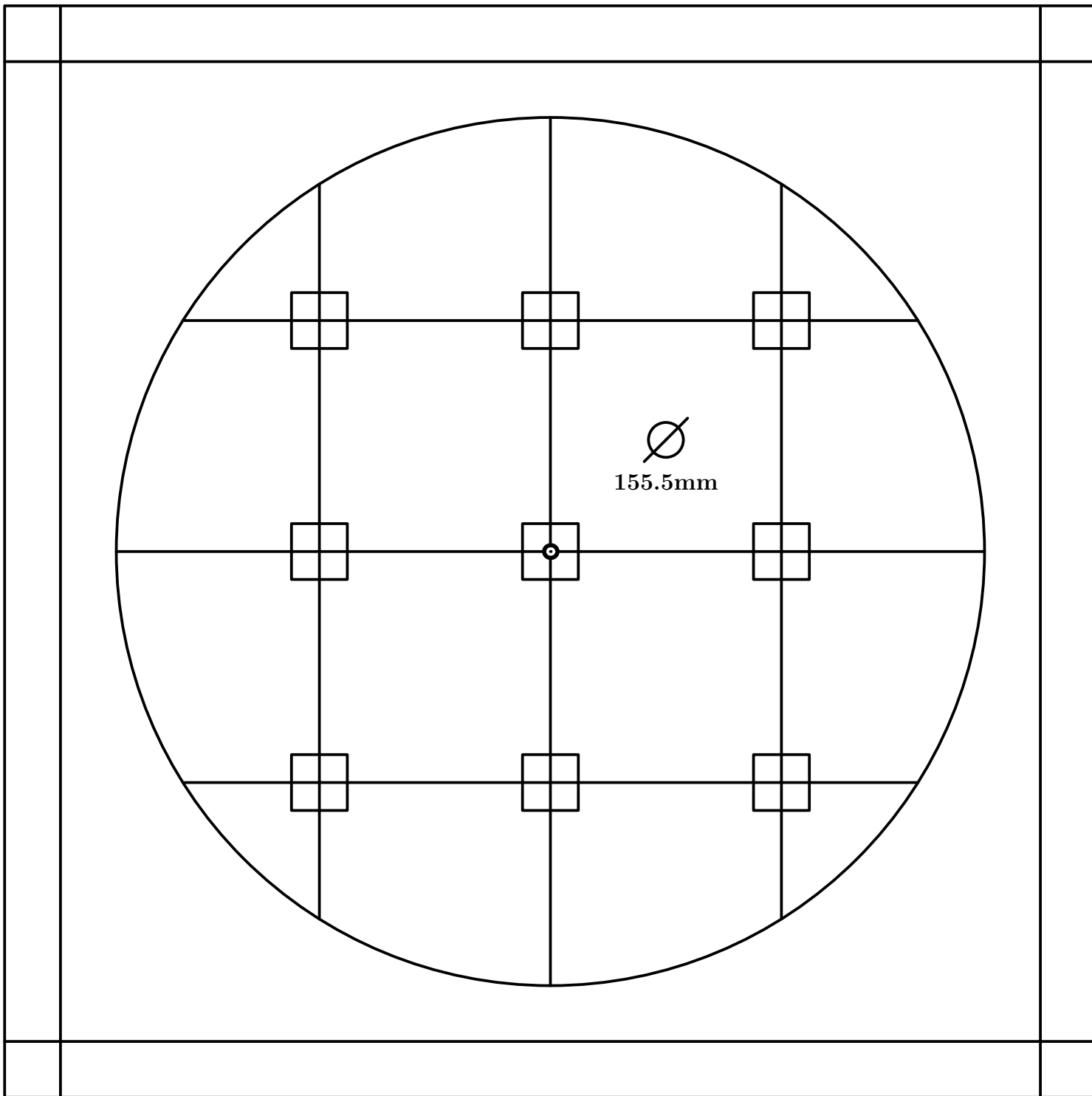

Fig. 223

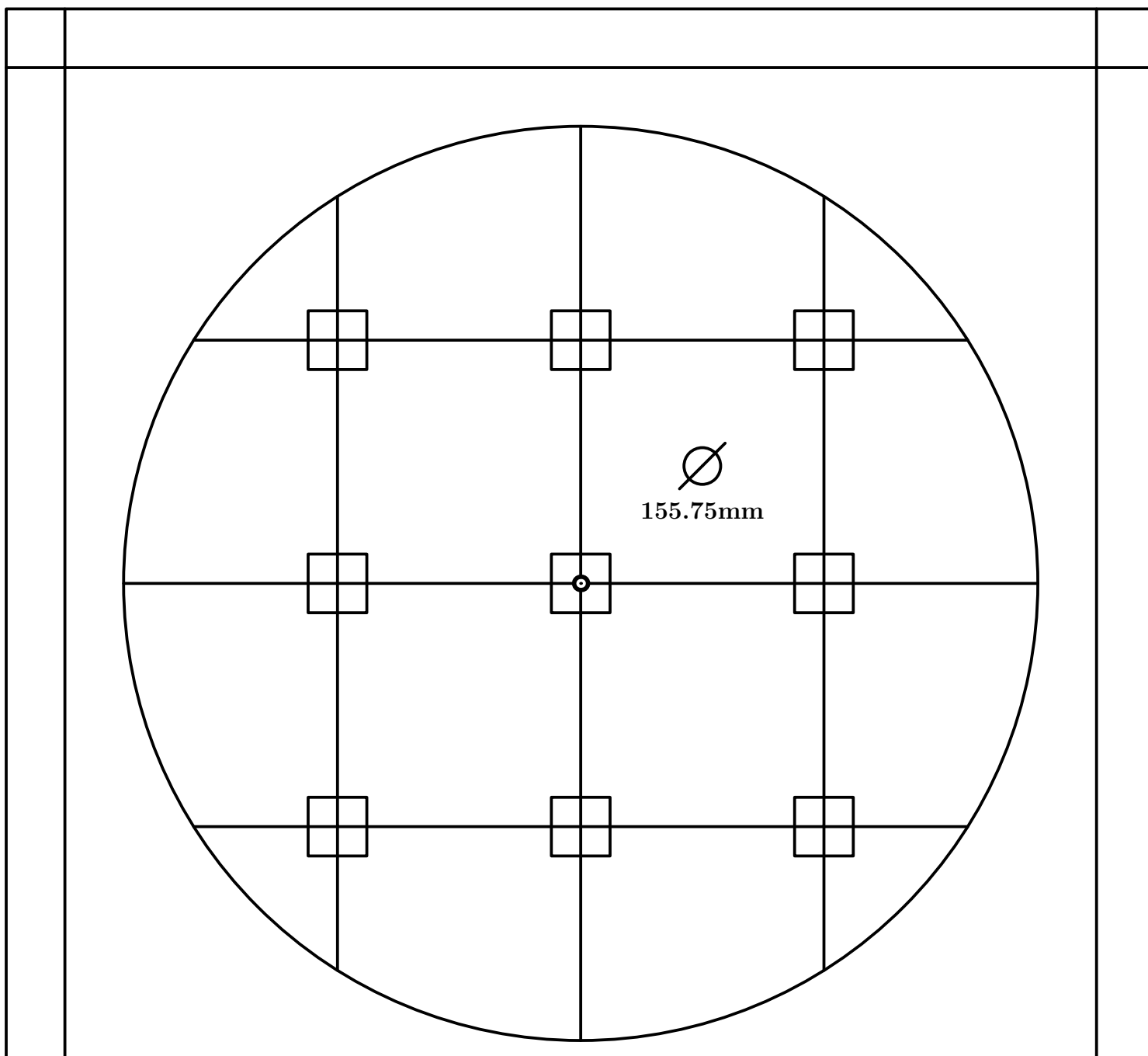

Fig. 224

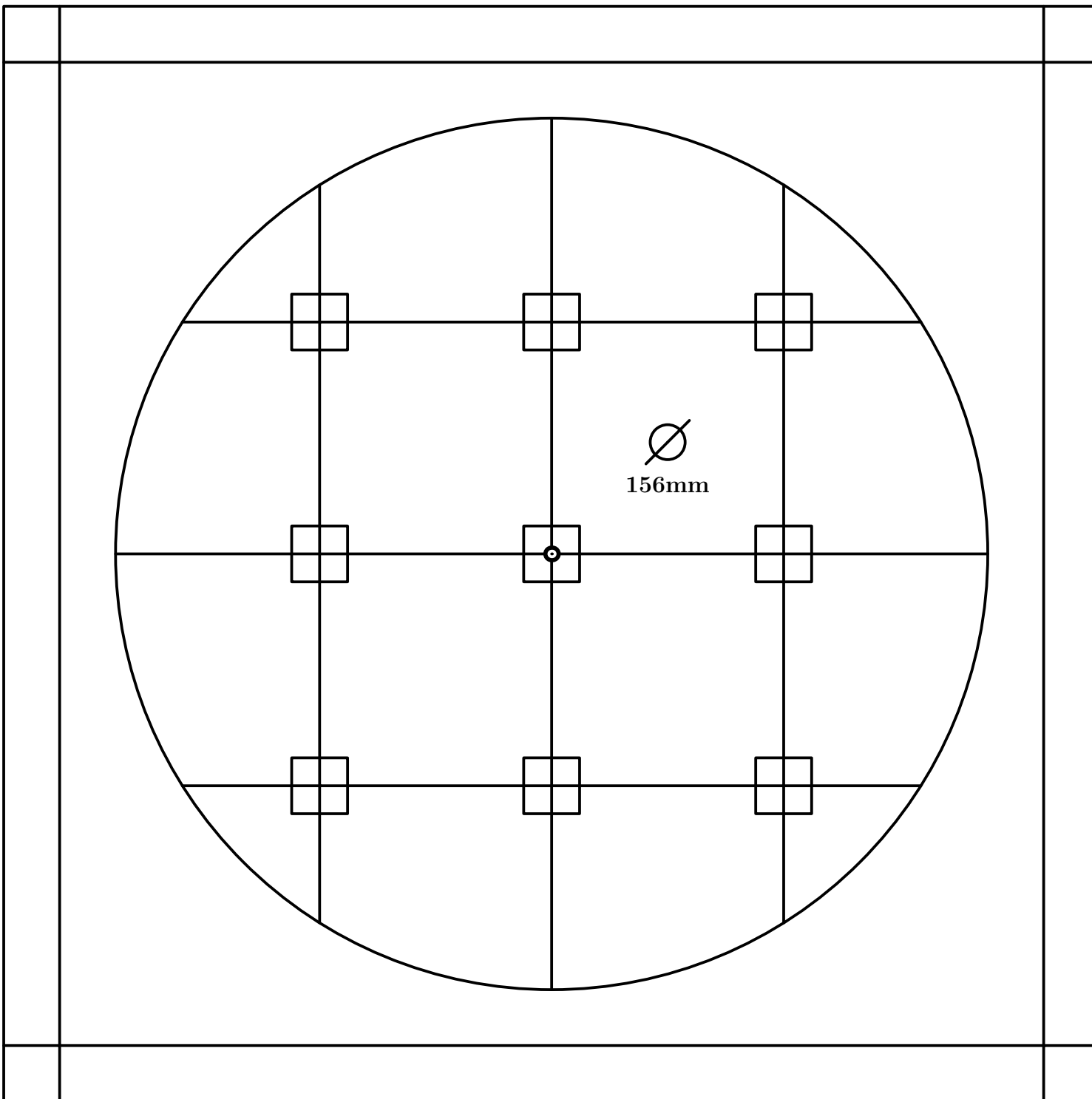

Fig. 225

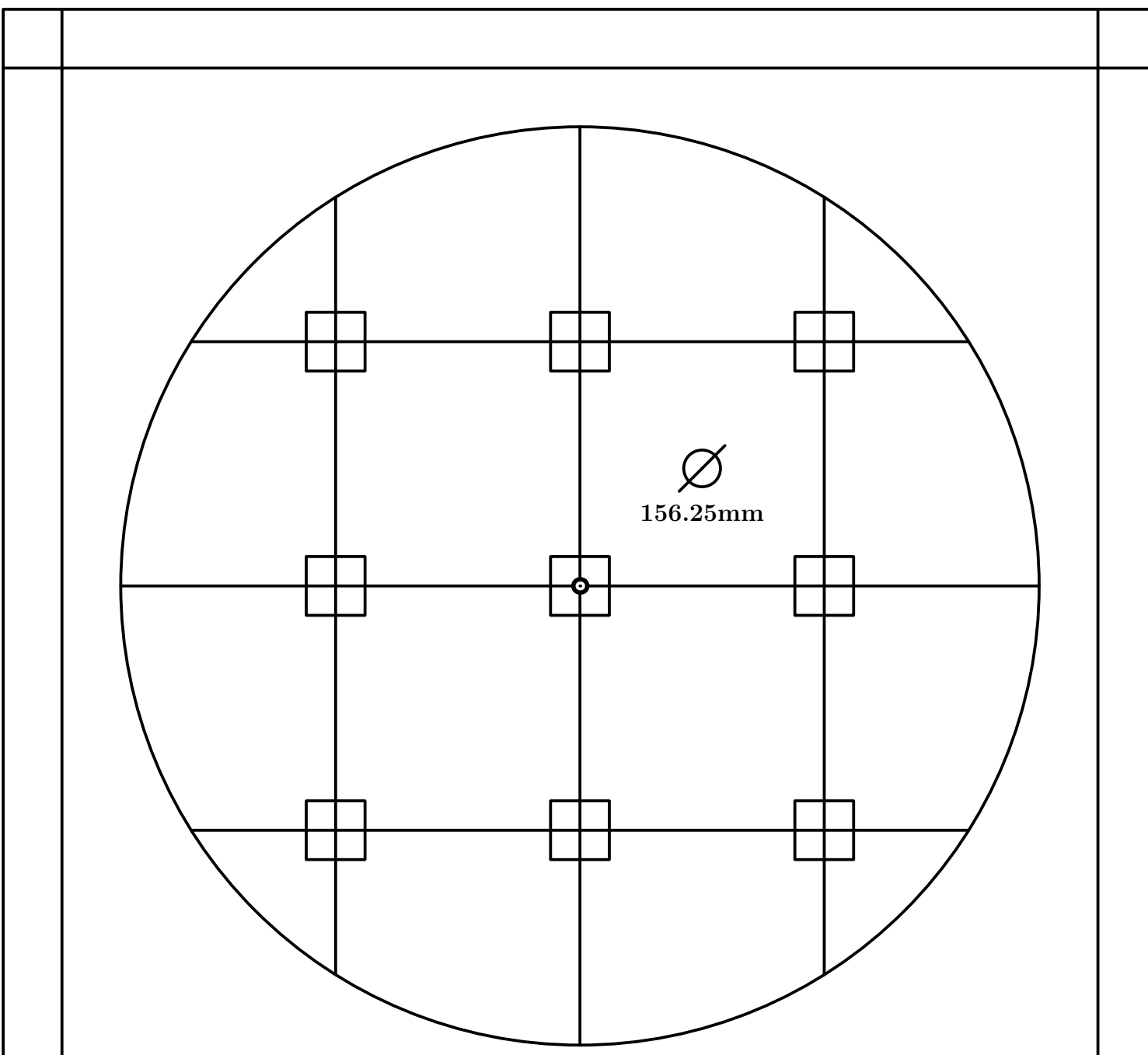

Fig. 226

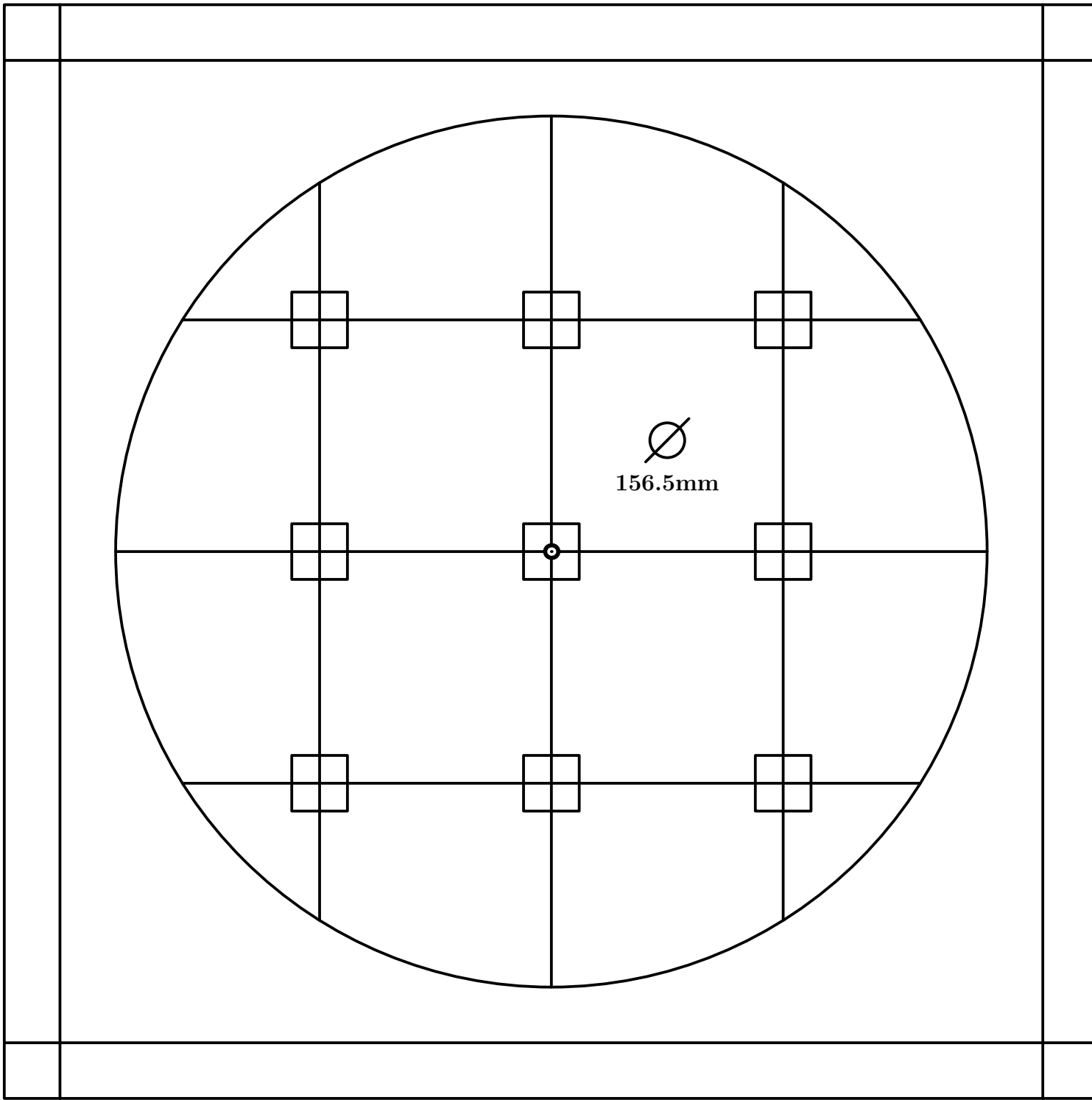

Fig. 227

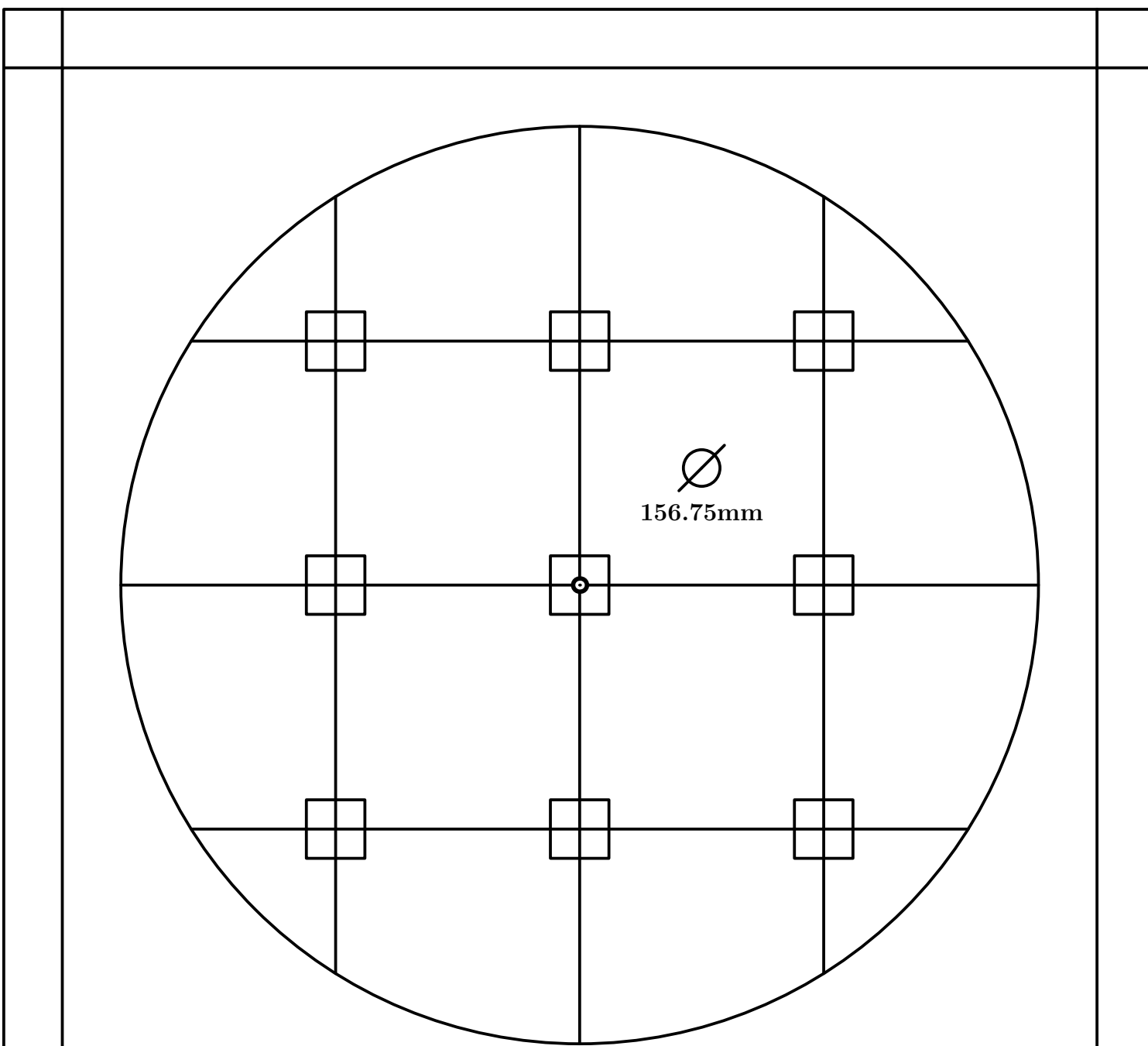

Fig. 228

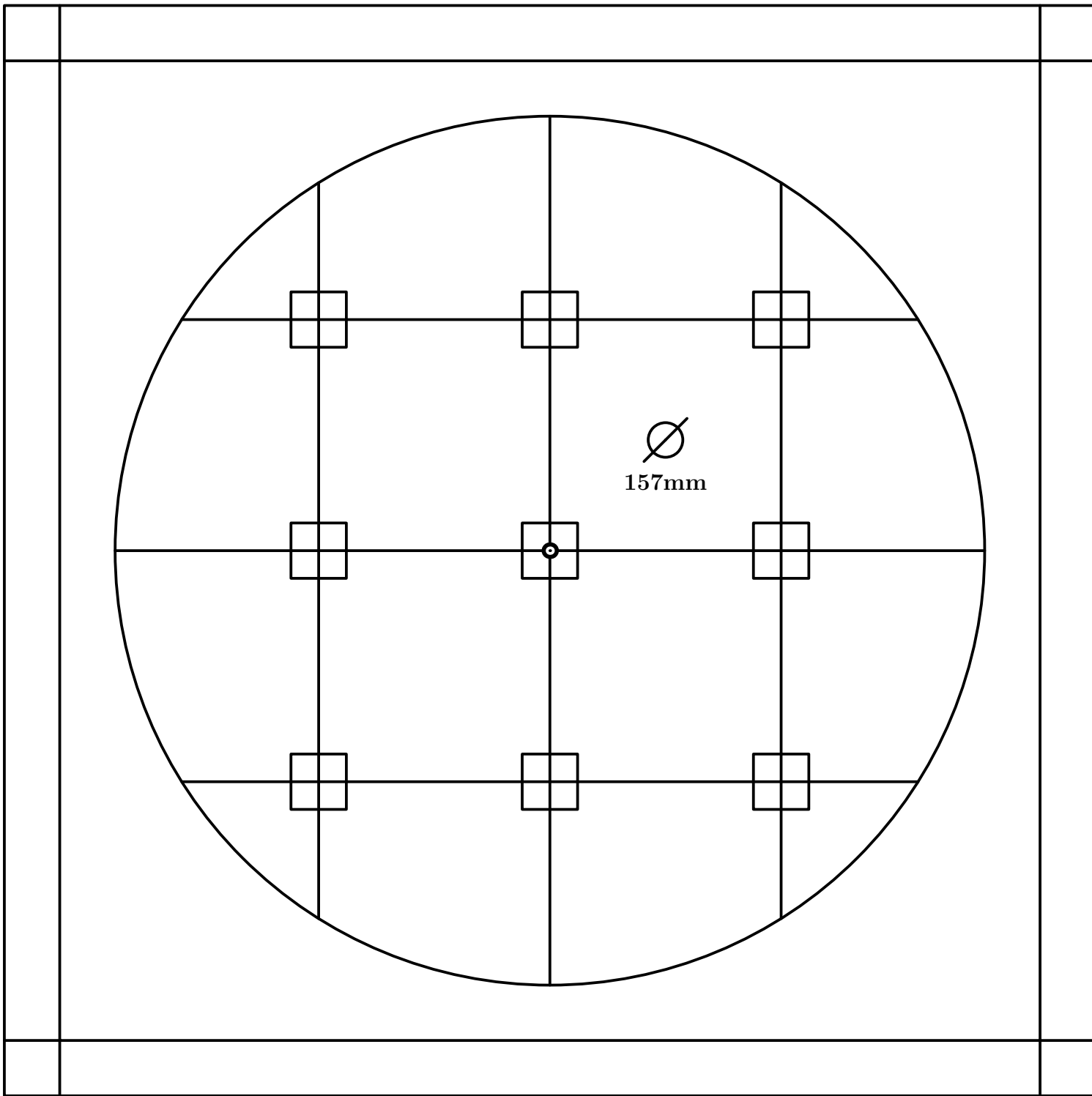

Fig. 229

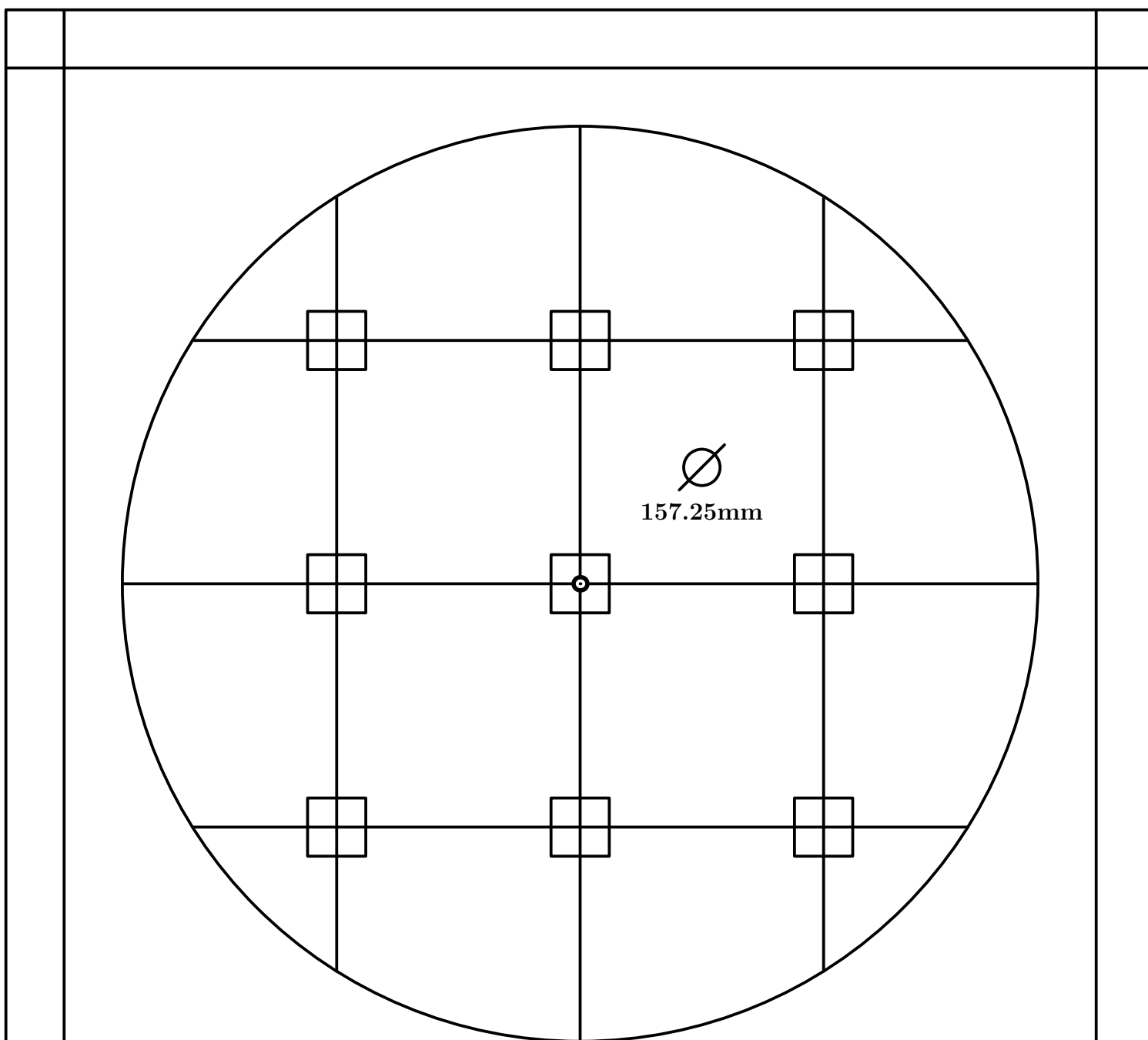

Fig. 230

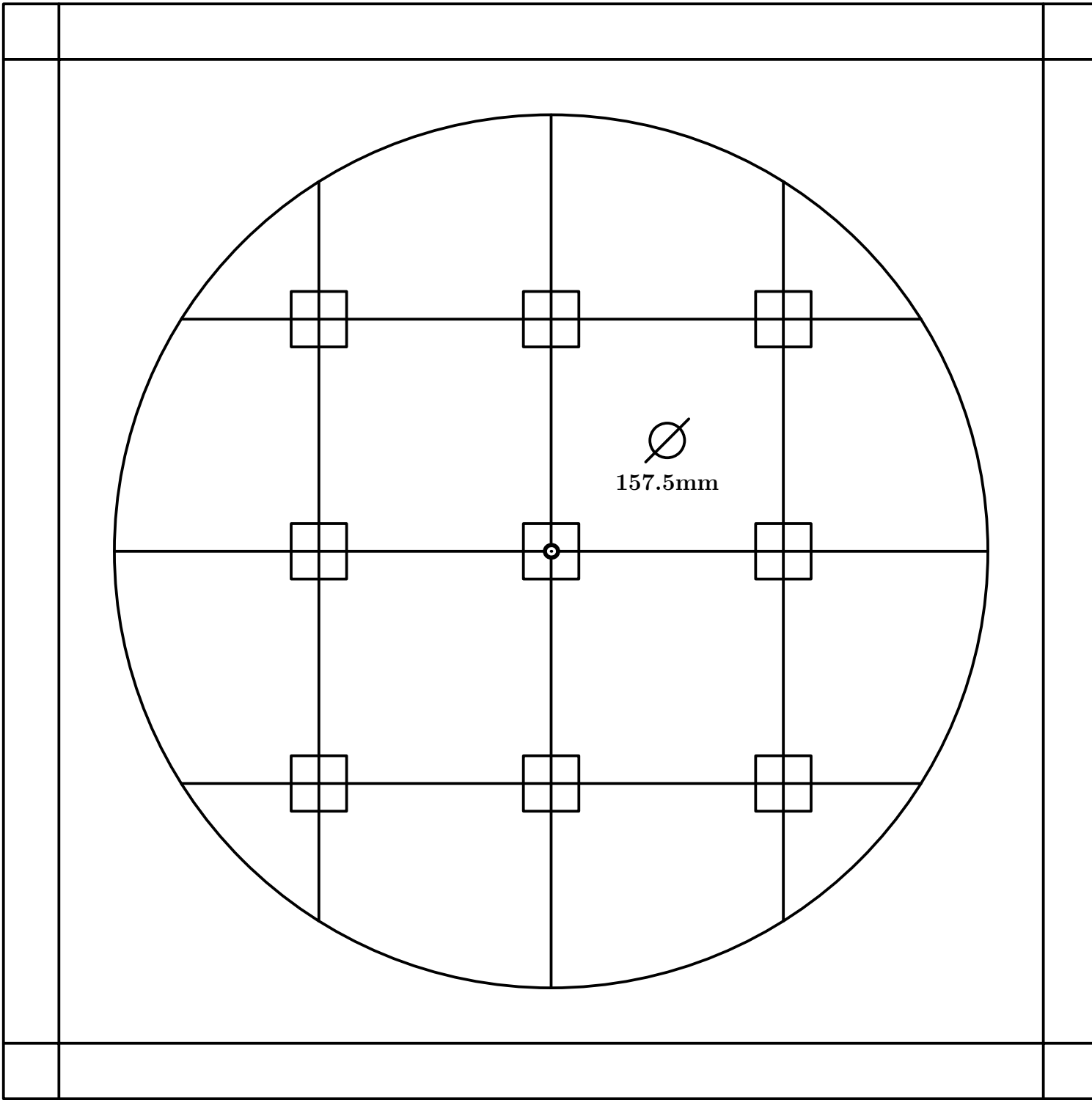

Fig. 231

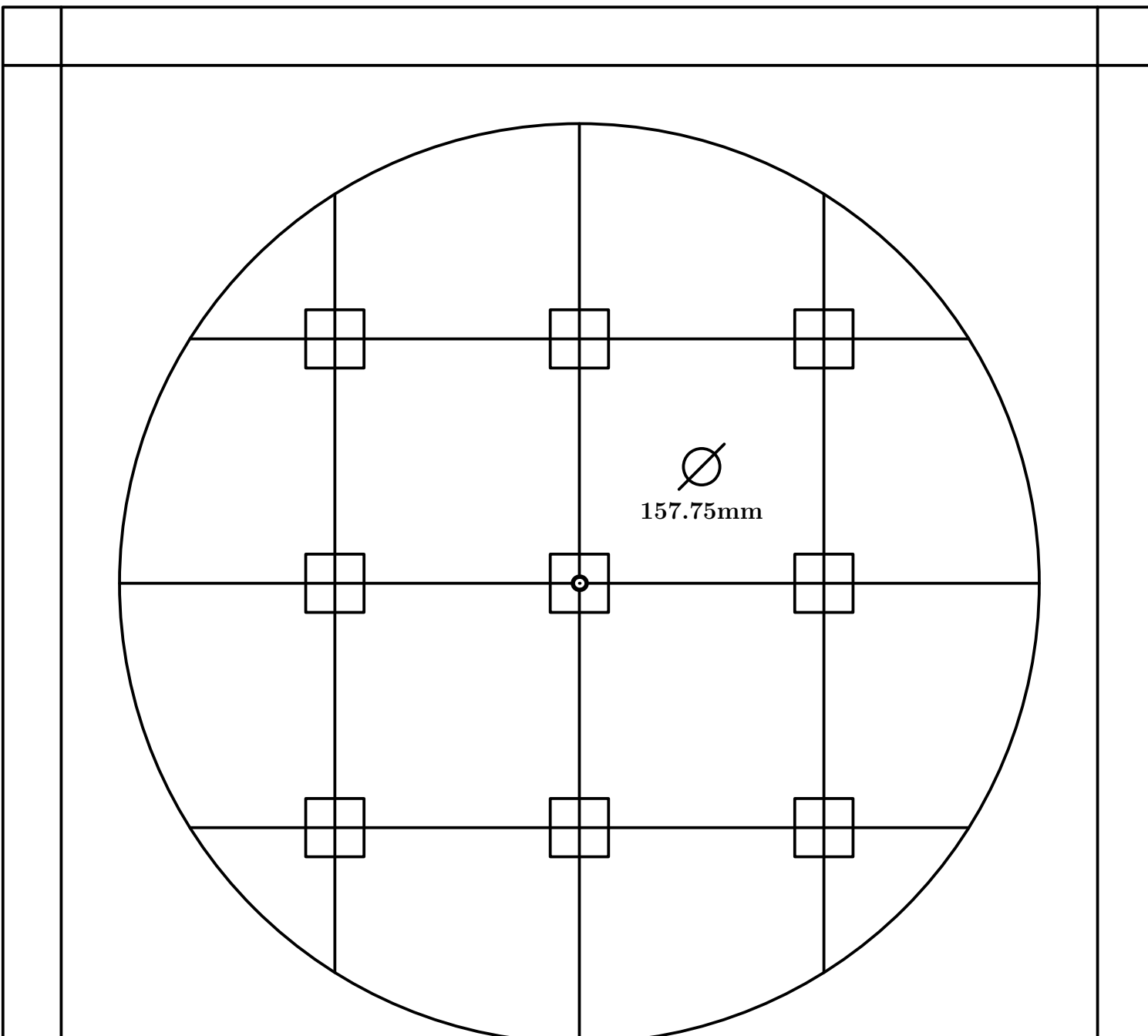

Fig. 232

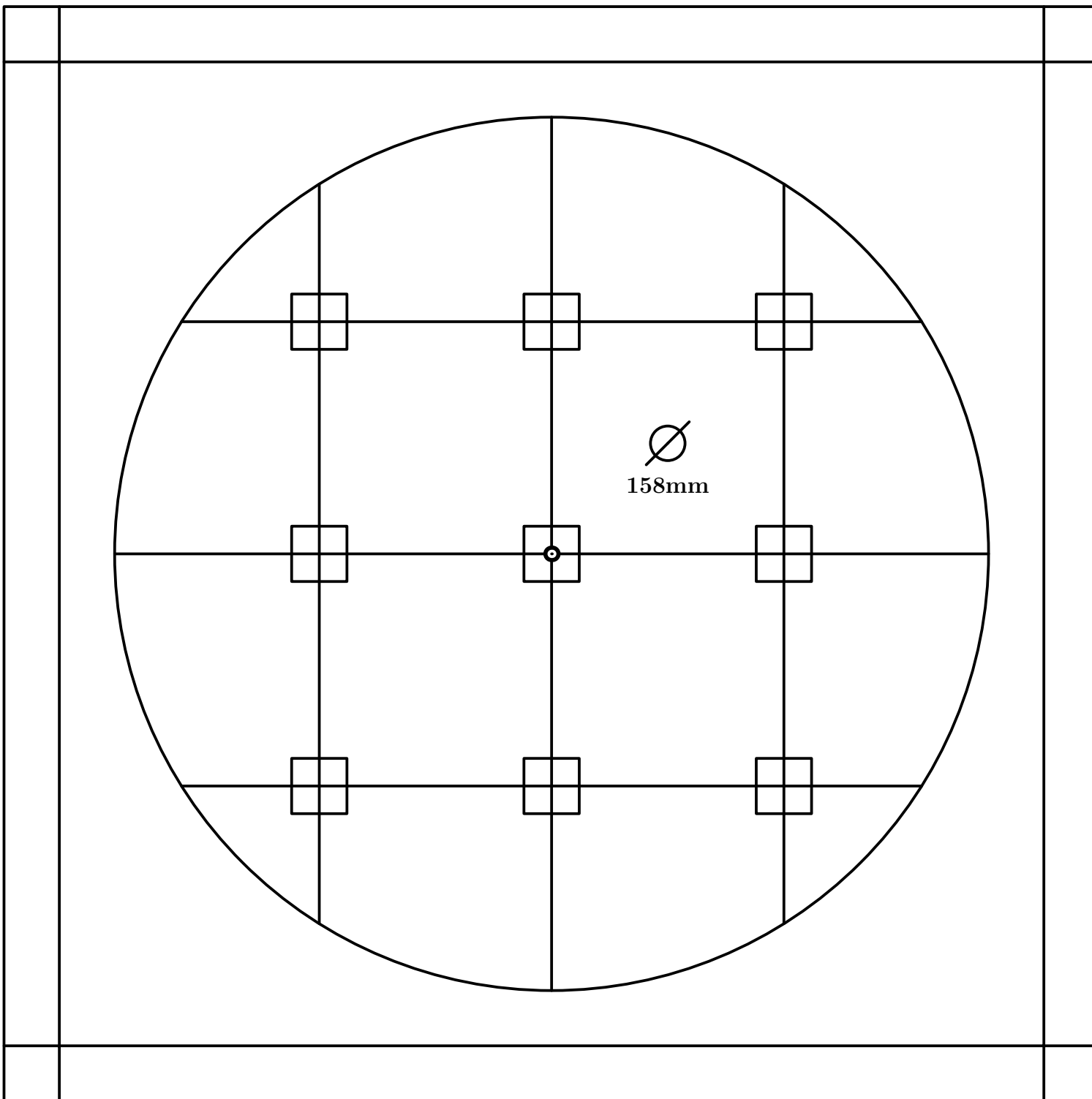

Fig. 233

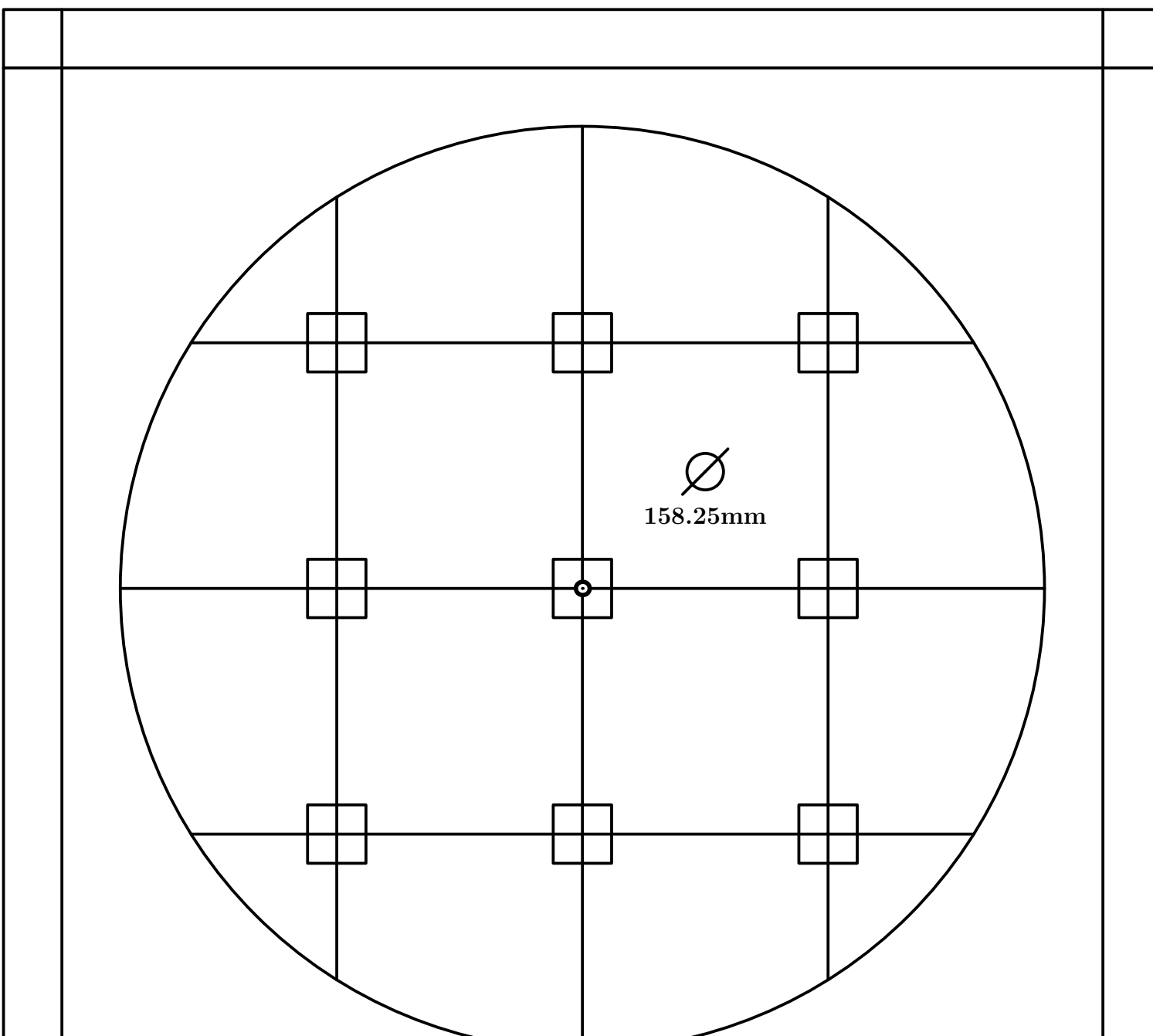

Fig. 234

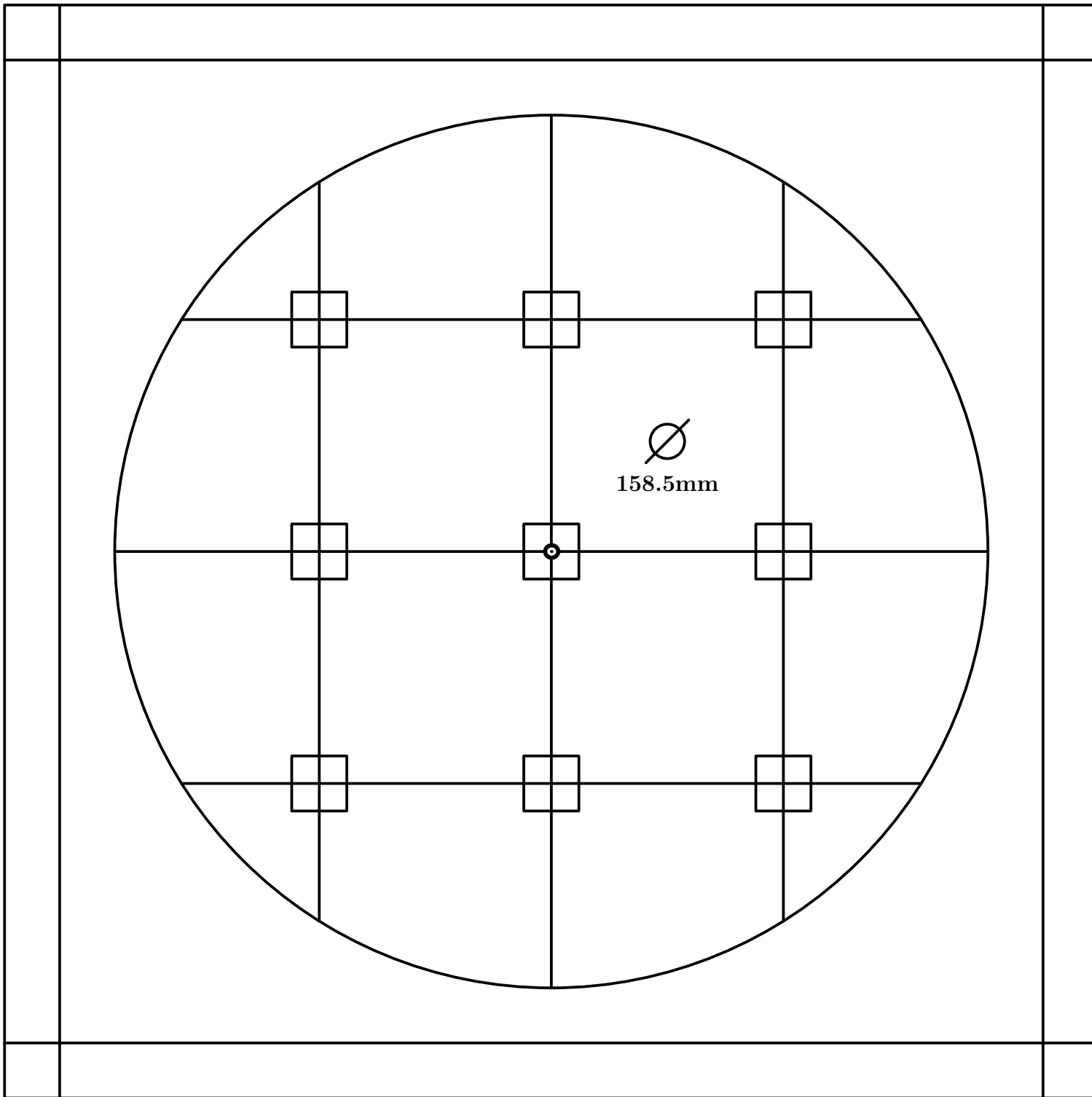

Fig. 235

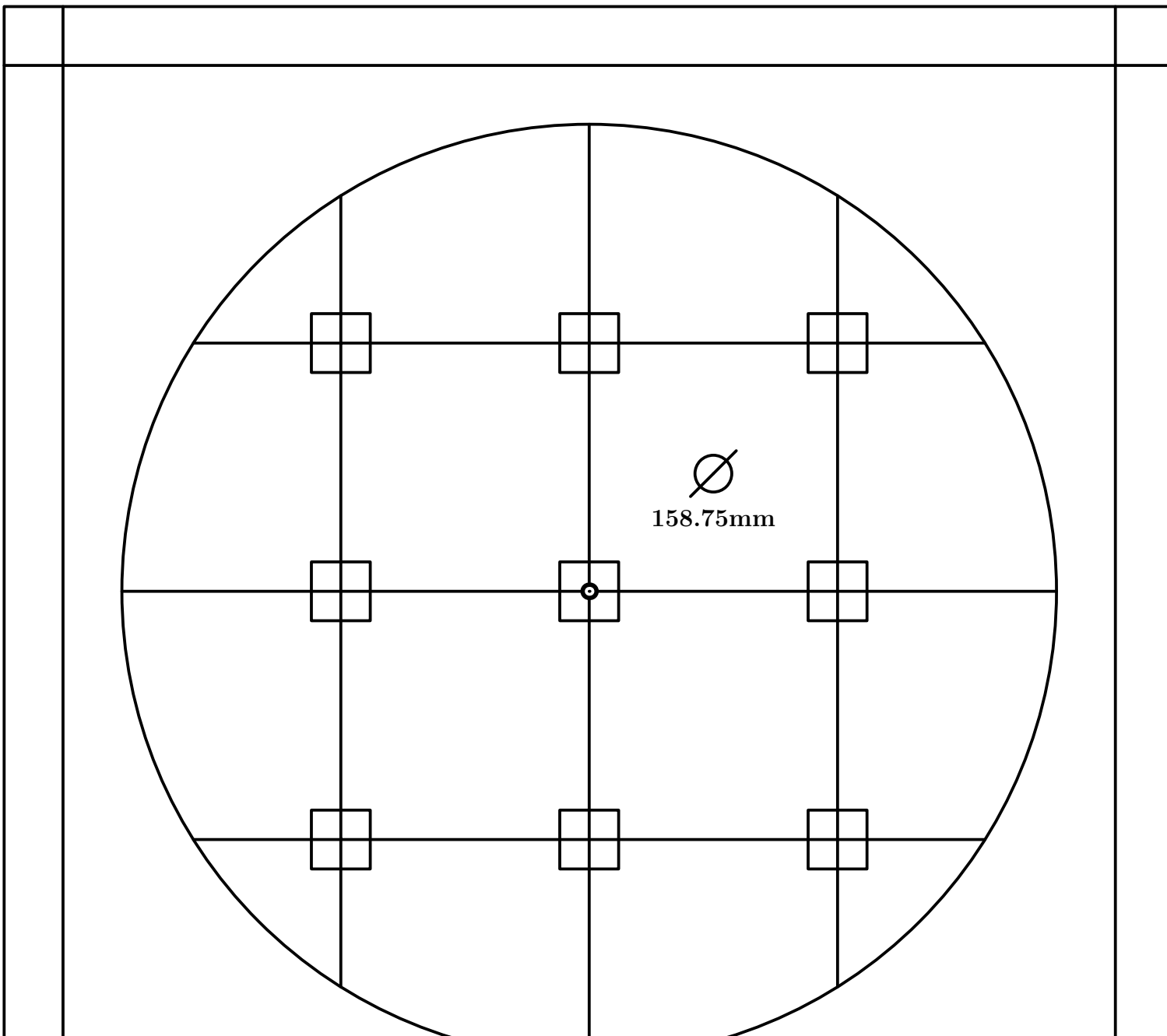

Fig. 236

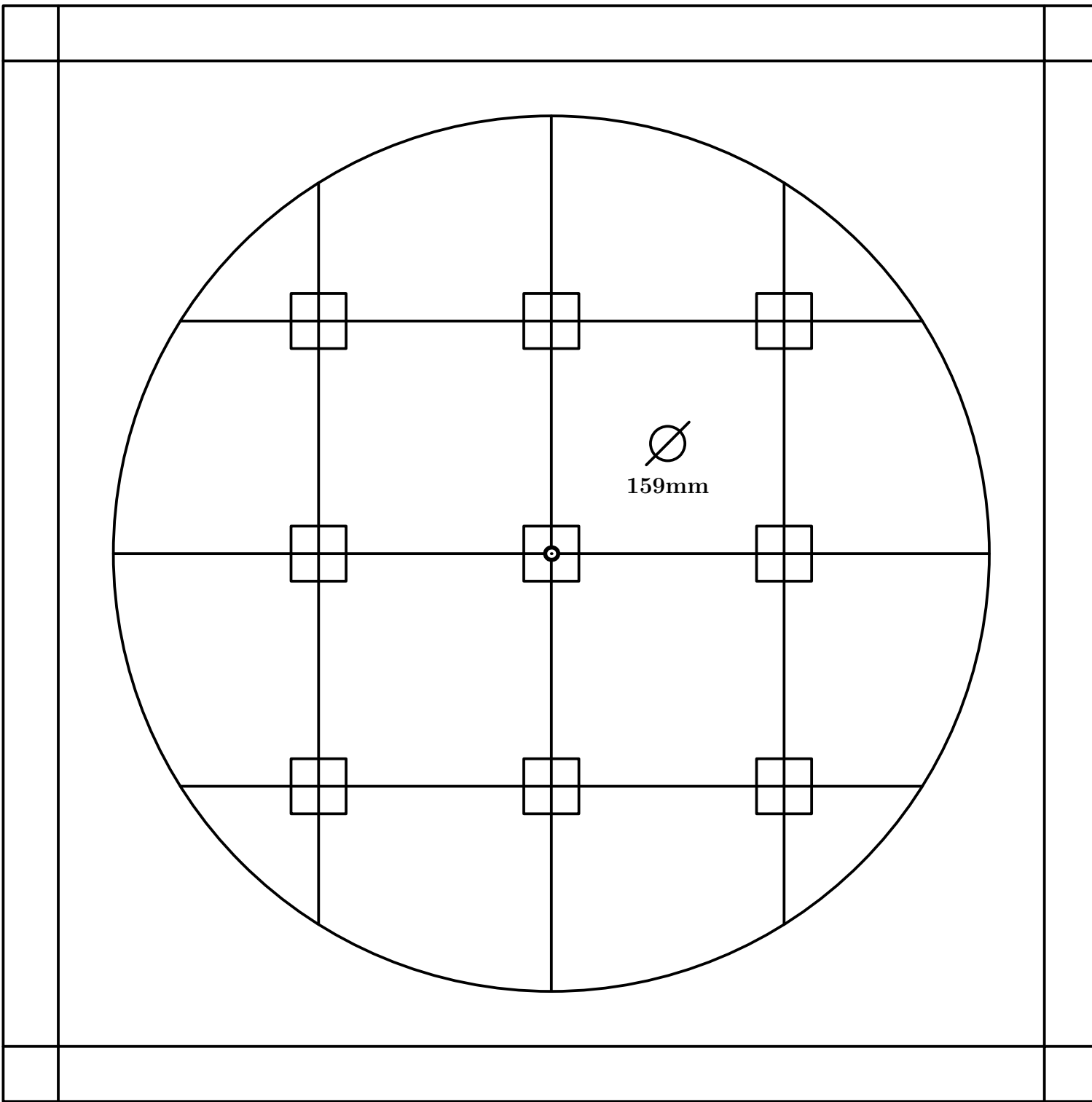

Fig. 237

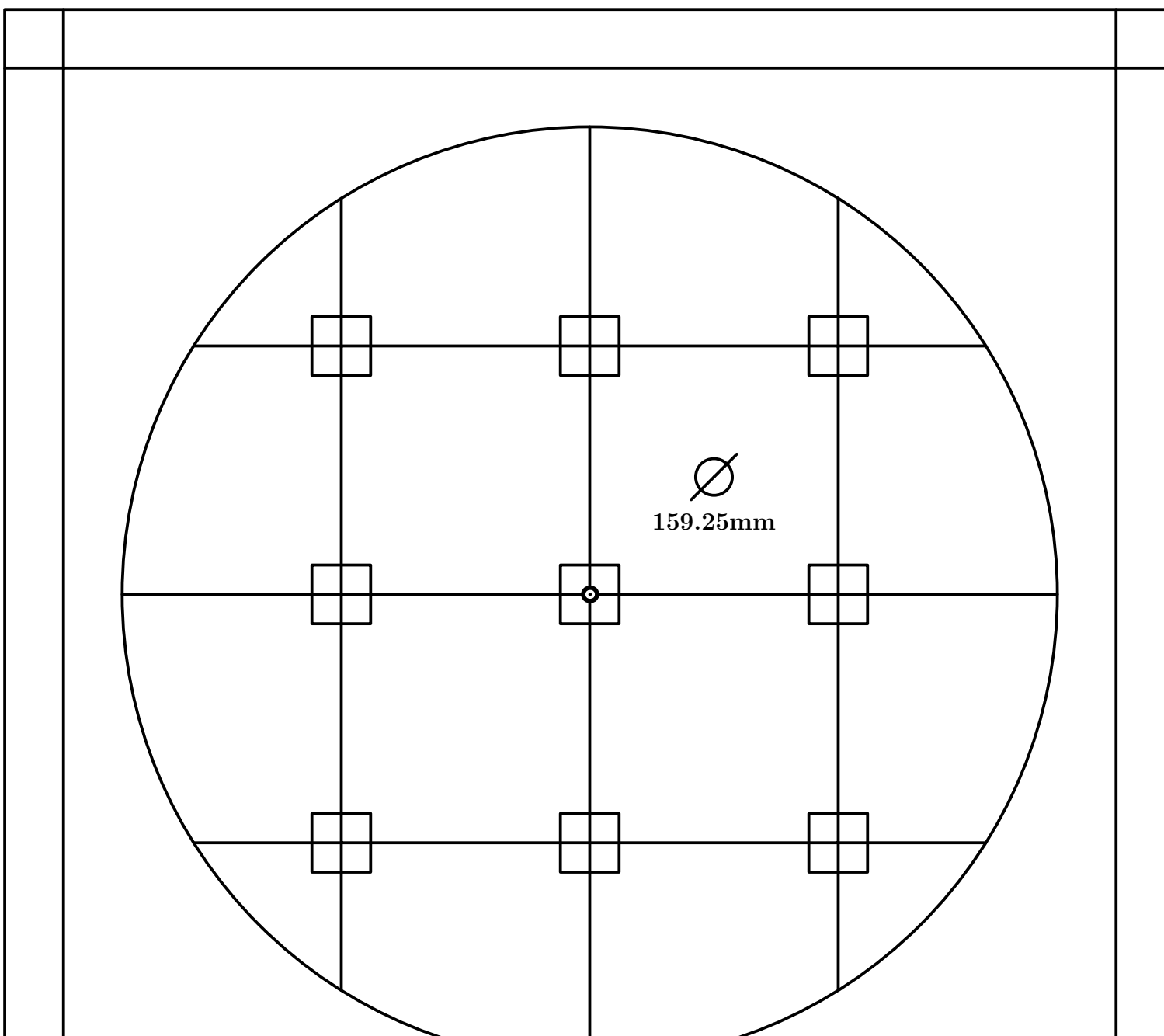

Fig. 238

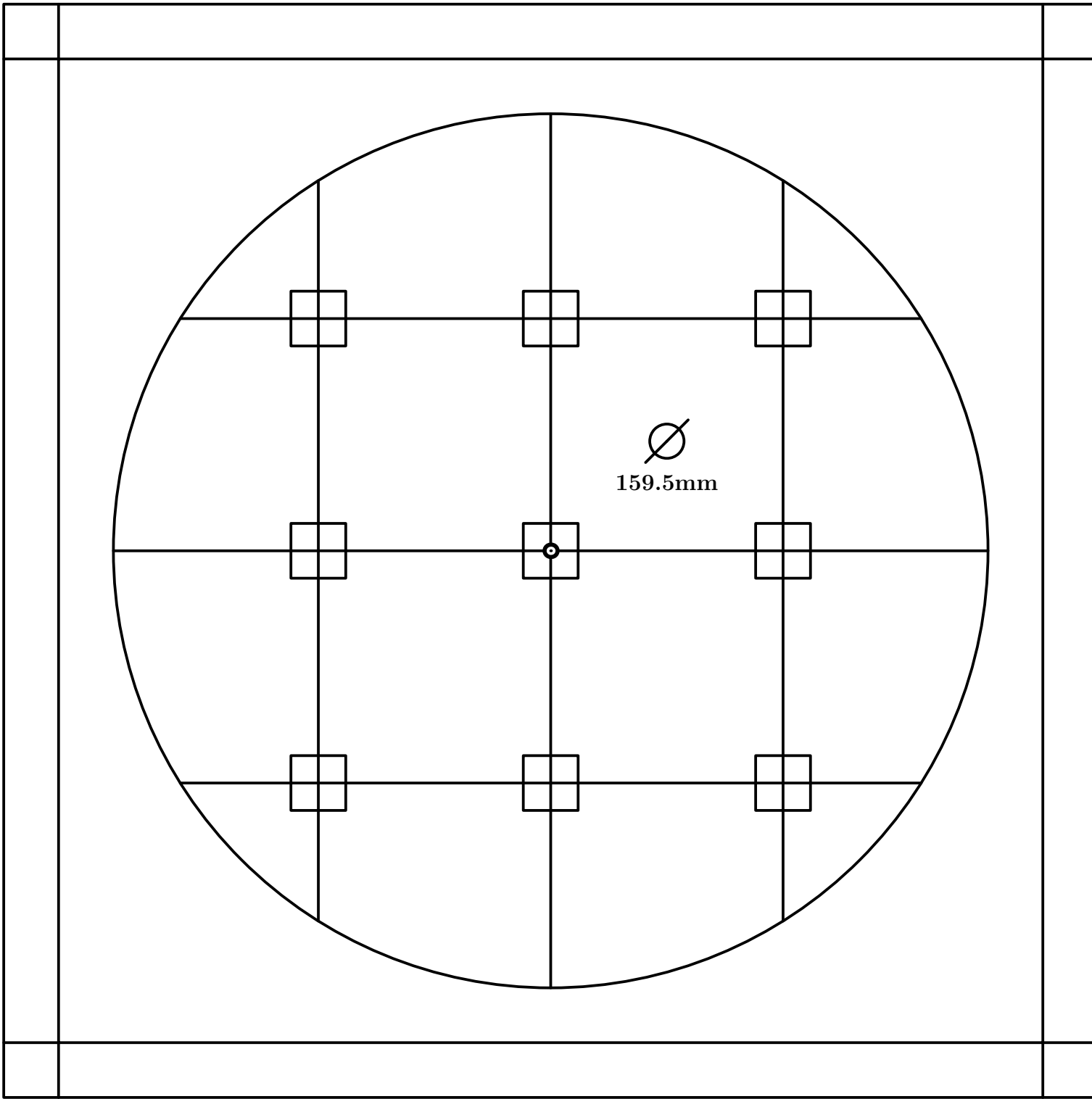

Fig. 239

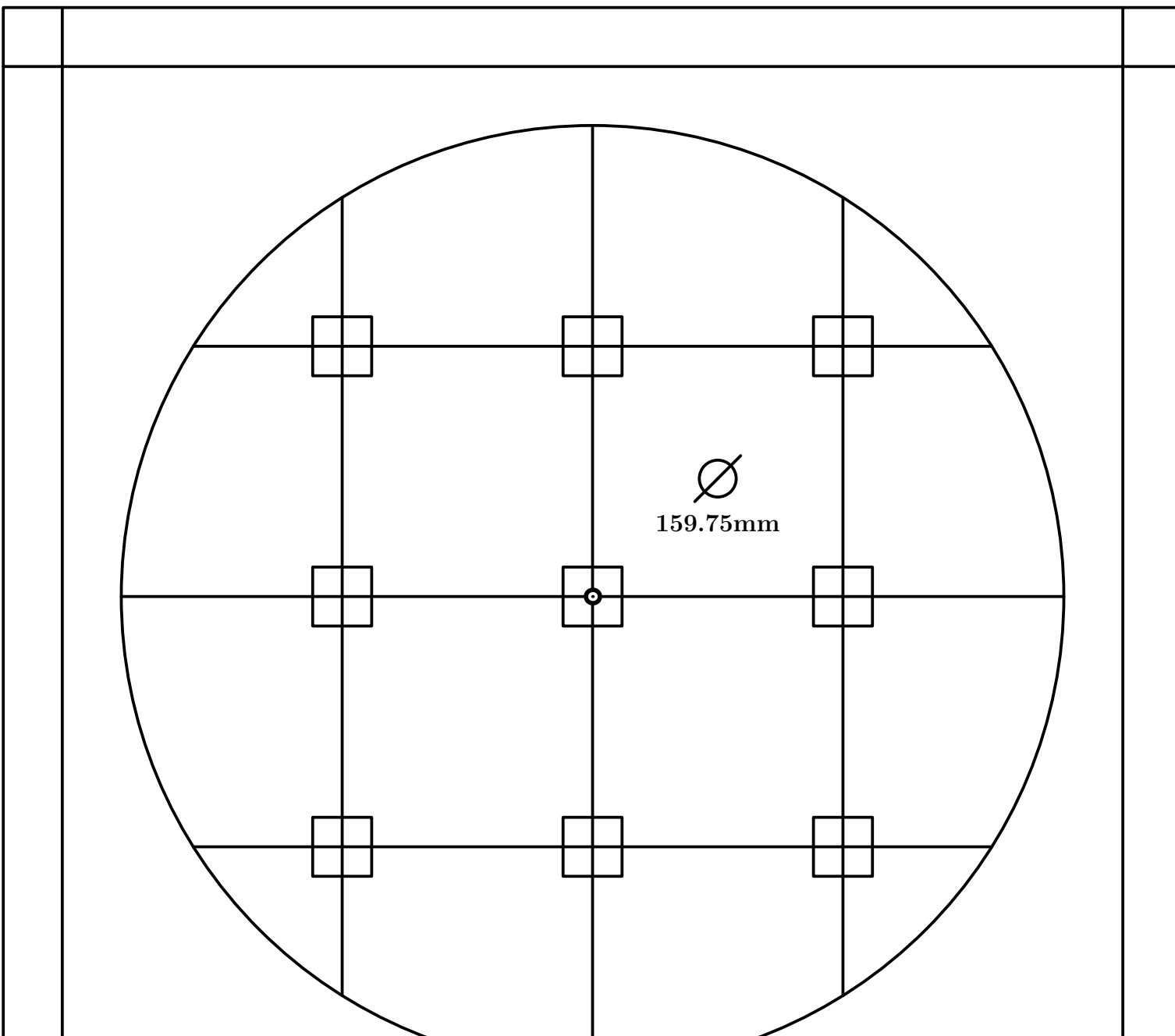

Fig. 240

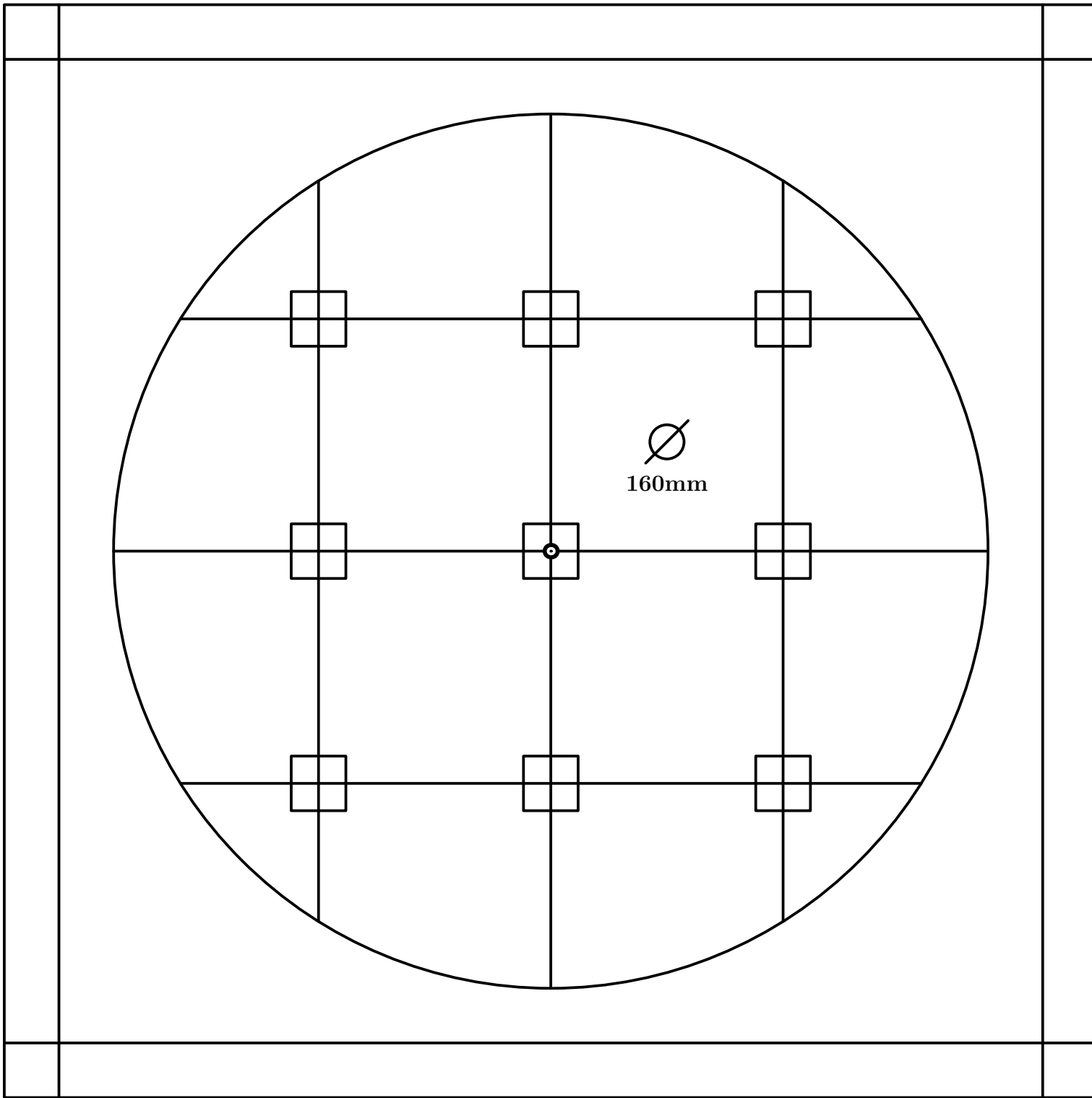

Fig. 241

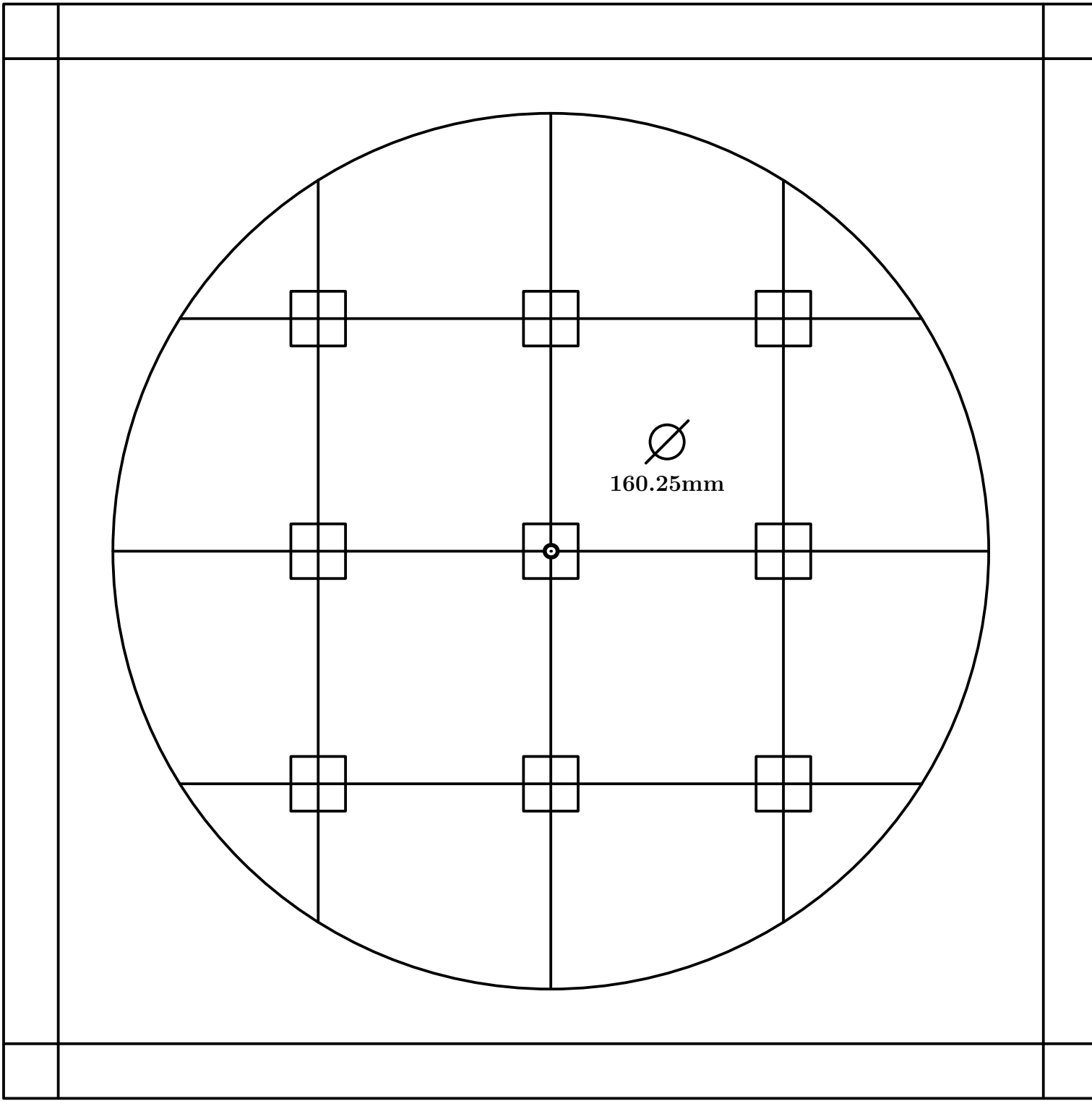

Fig. 242

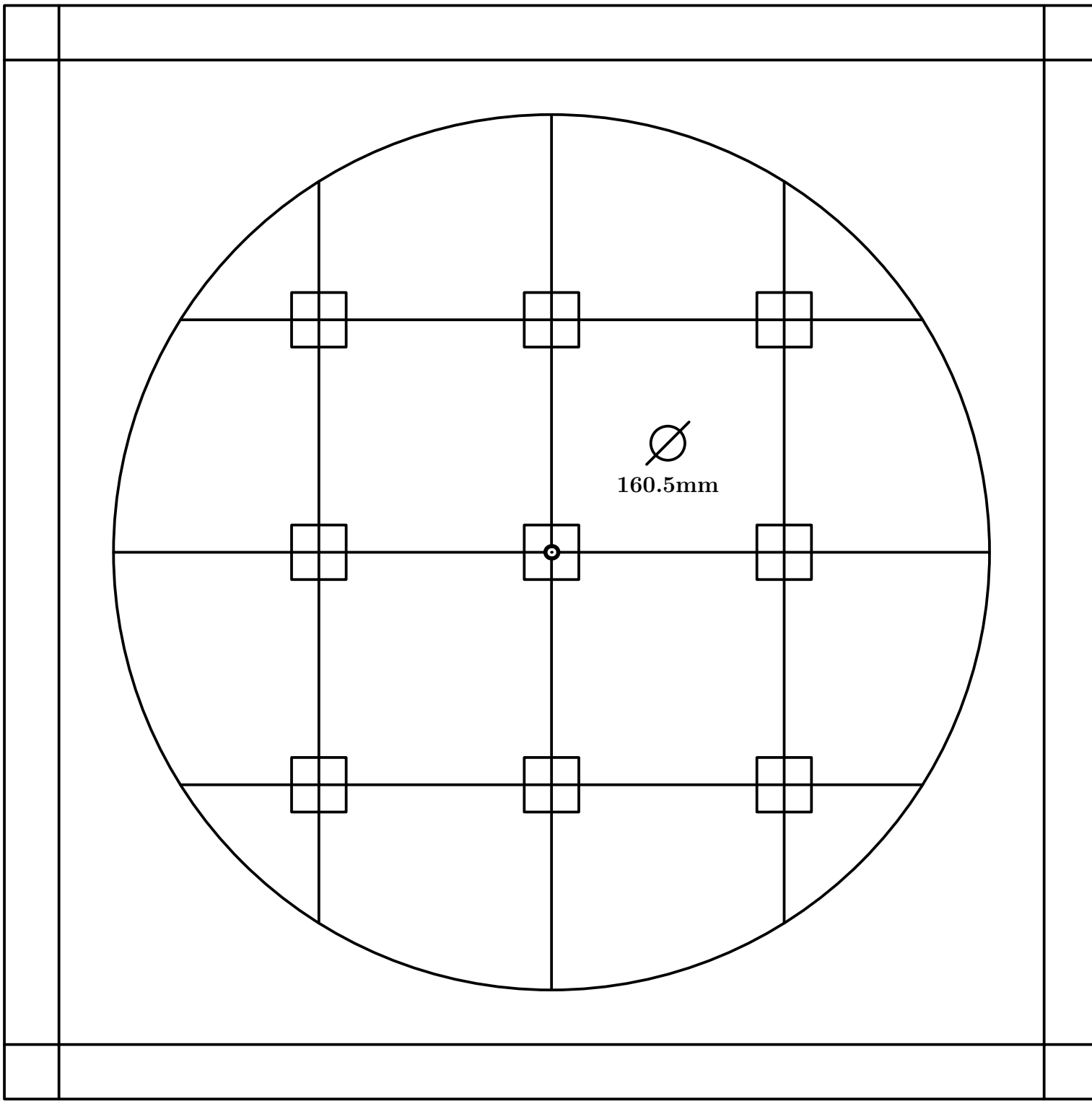

Fig. 243

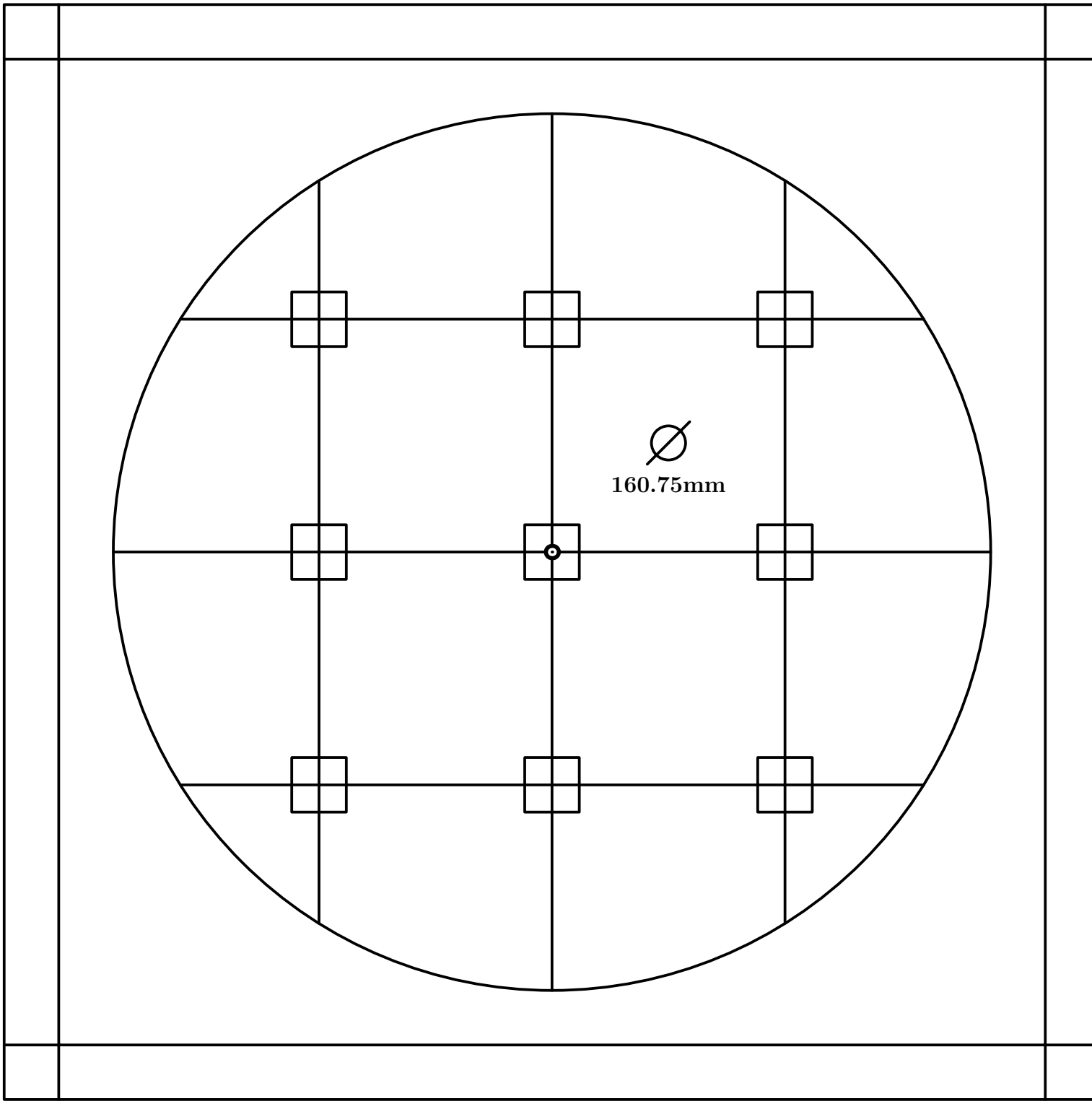

Fig. 244

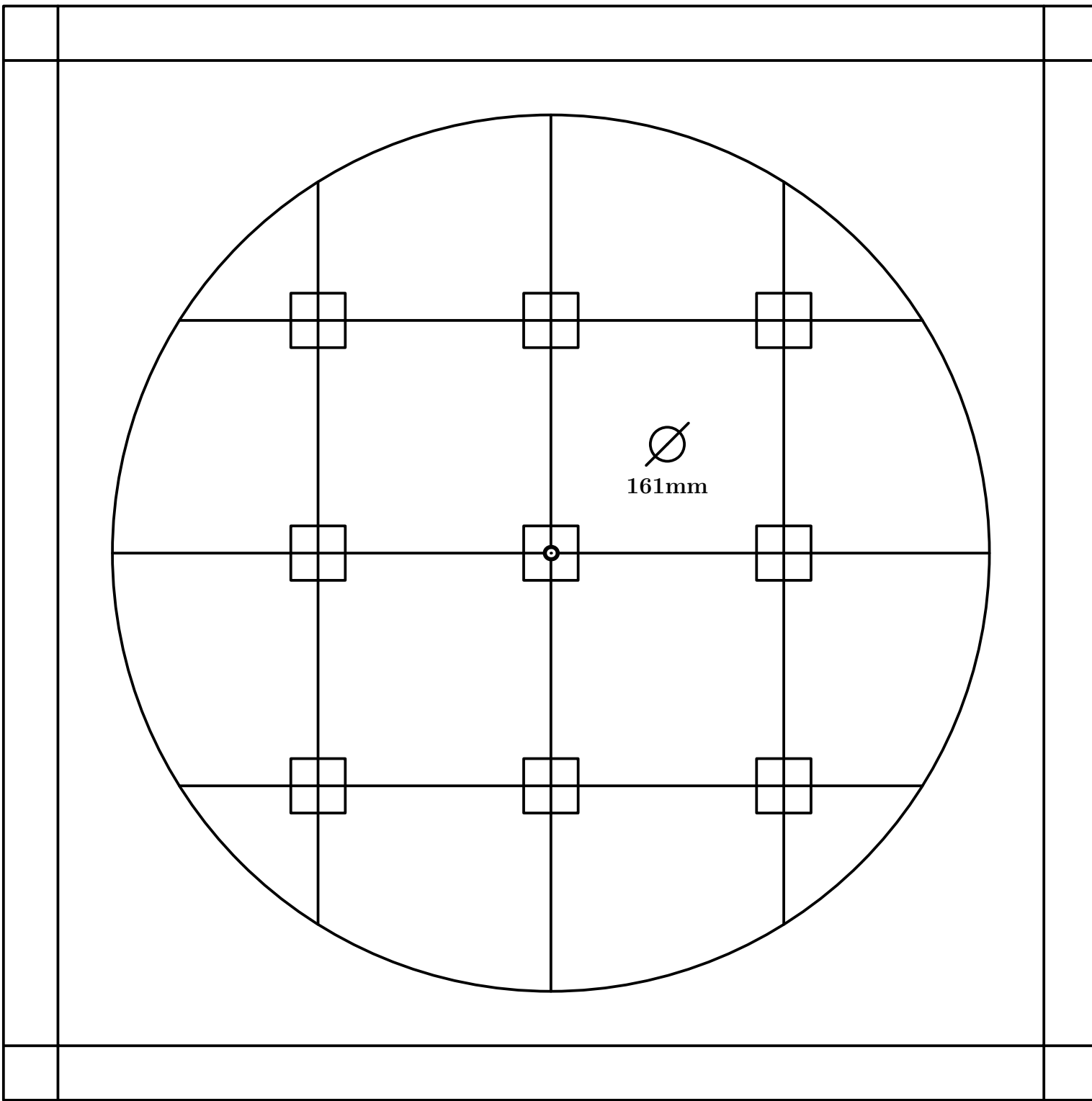

Fig. 245

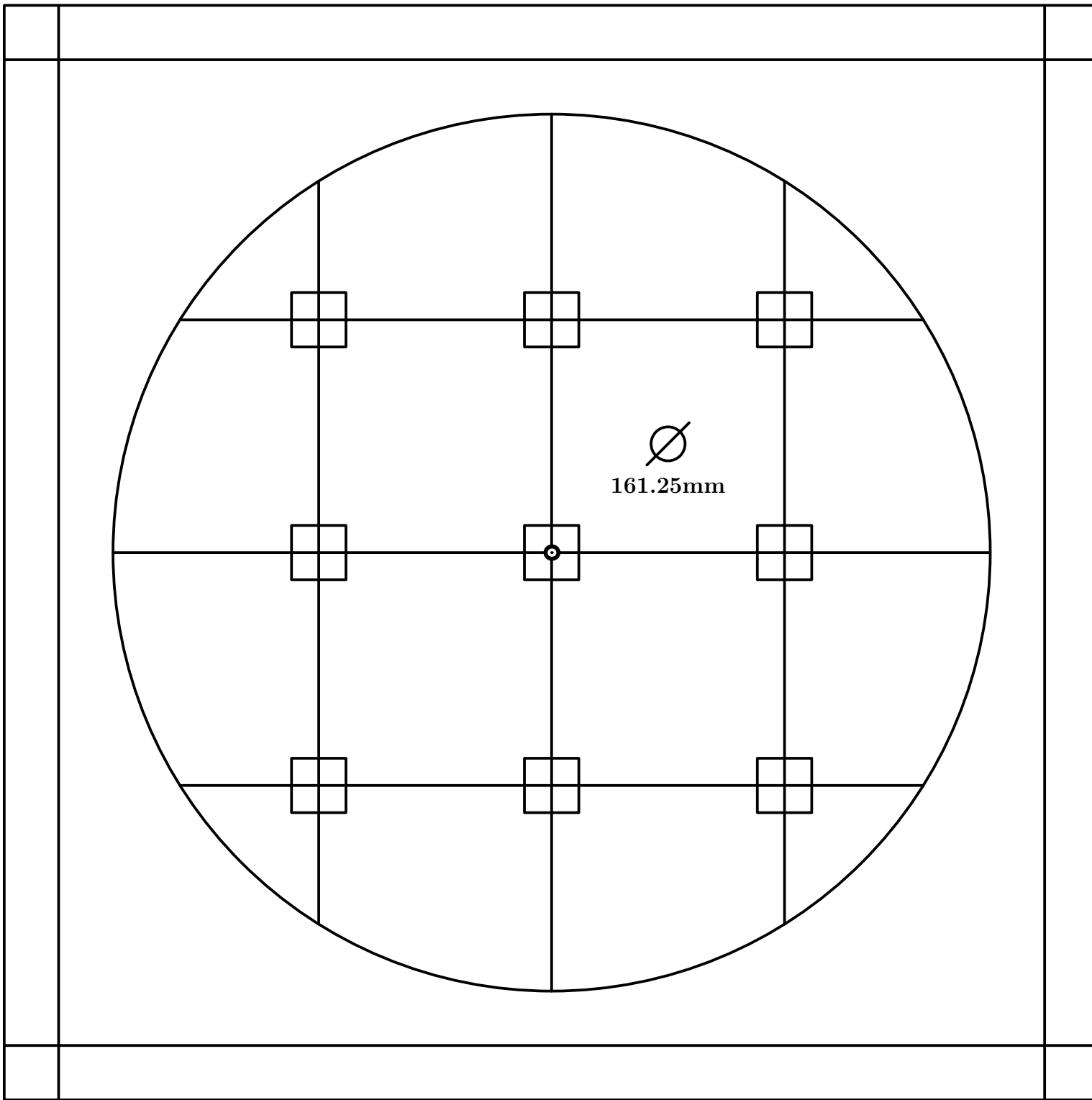

Fig. 246

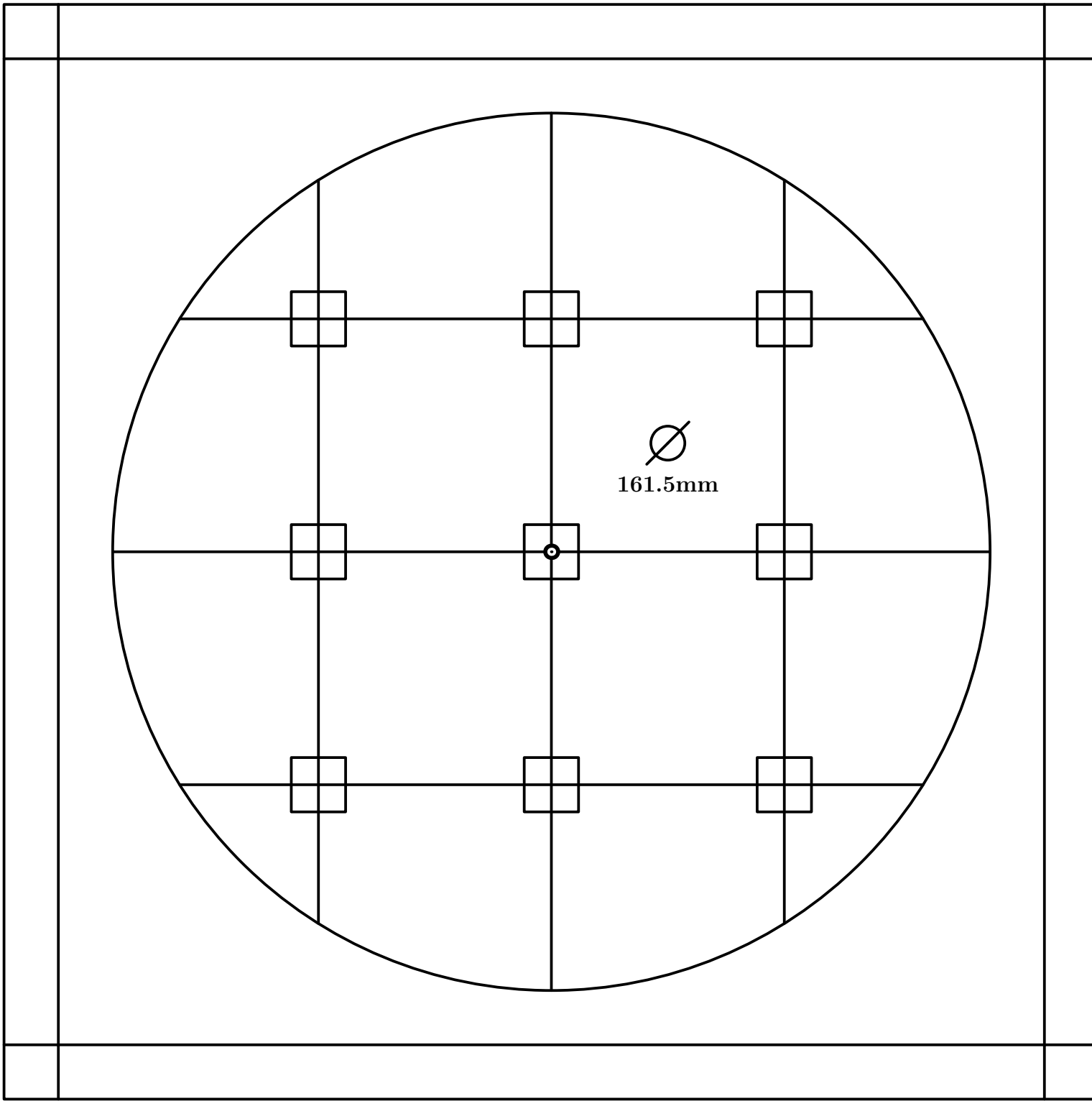

Fig. 247

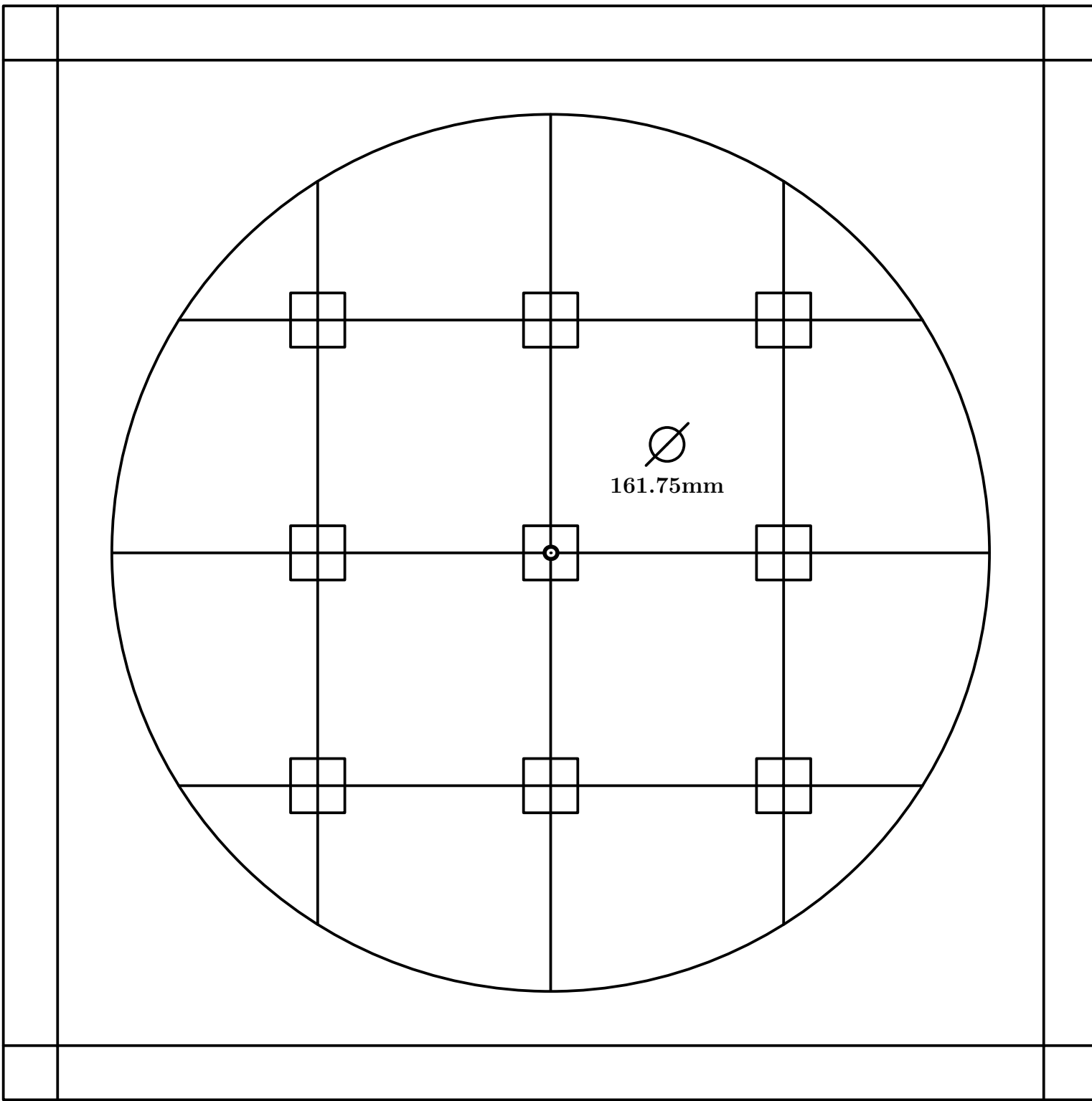

Fig. 248

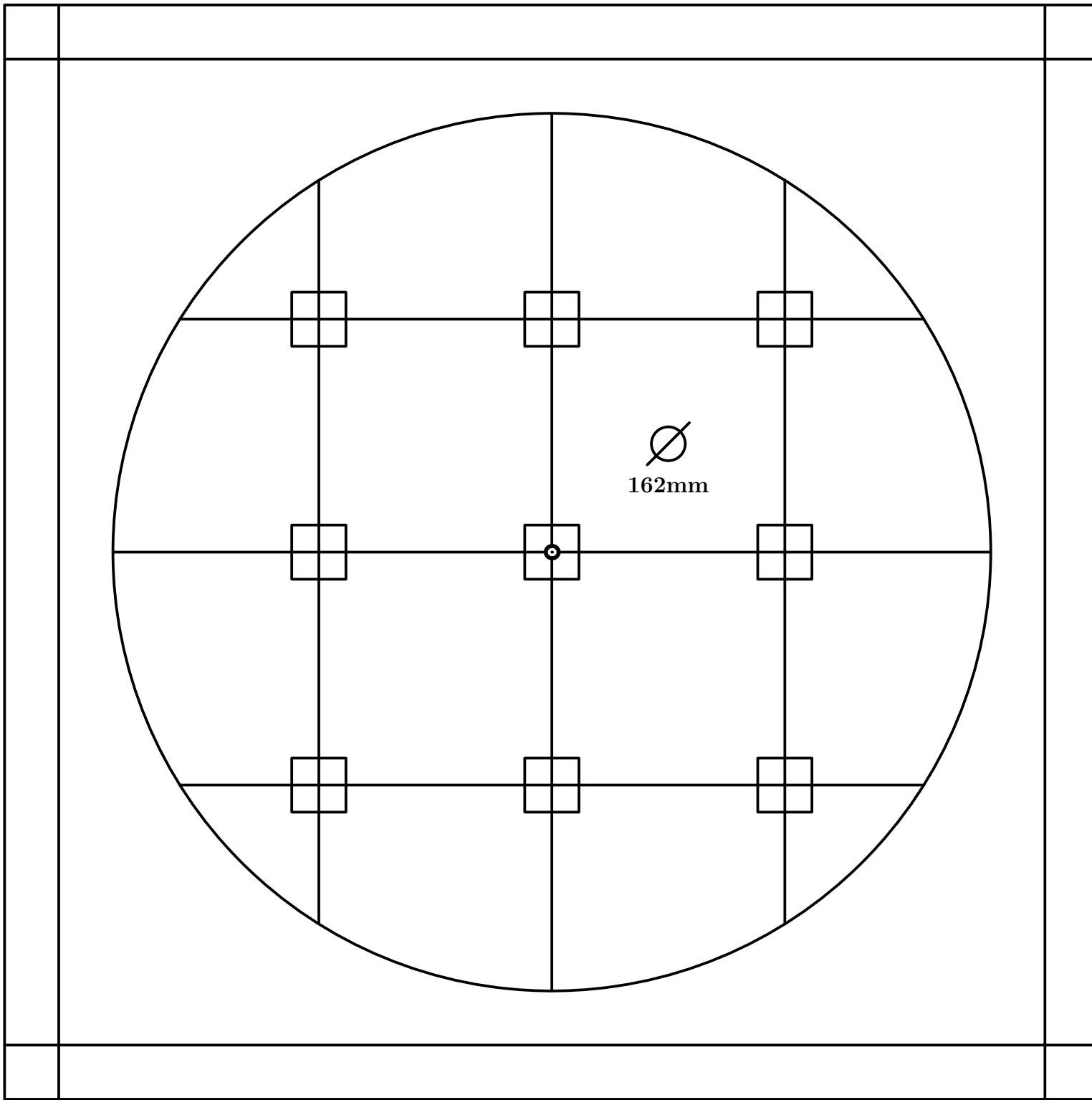

Fig. 249

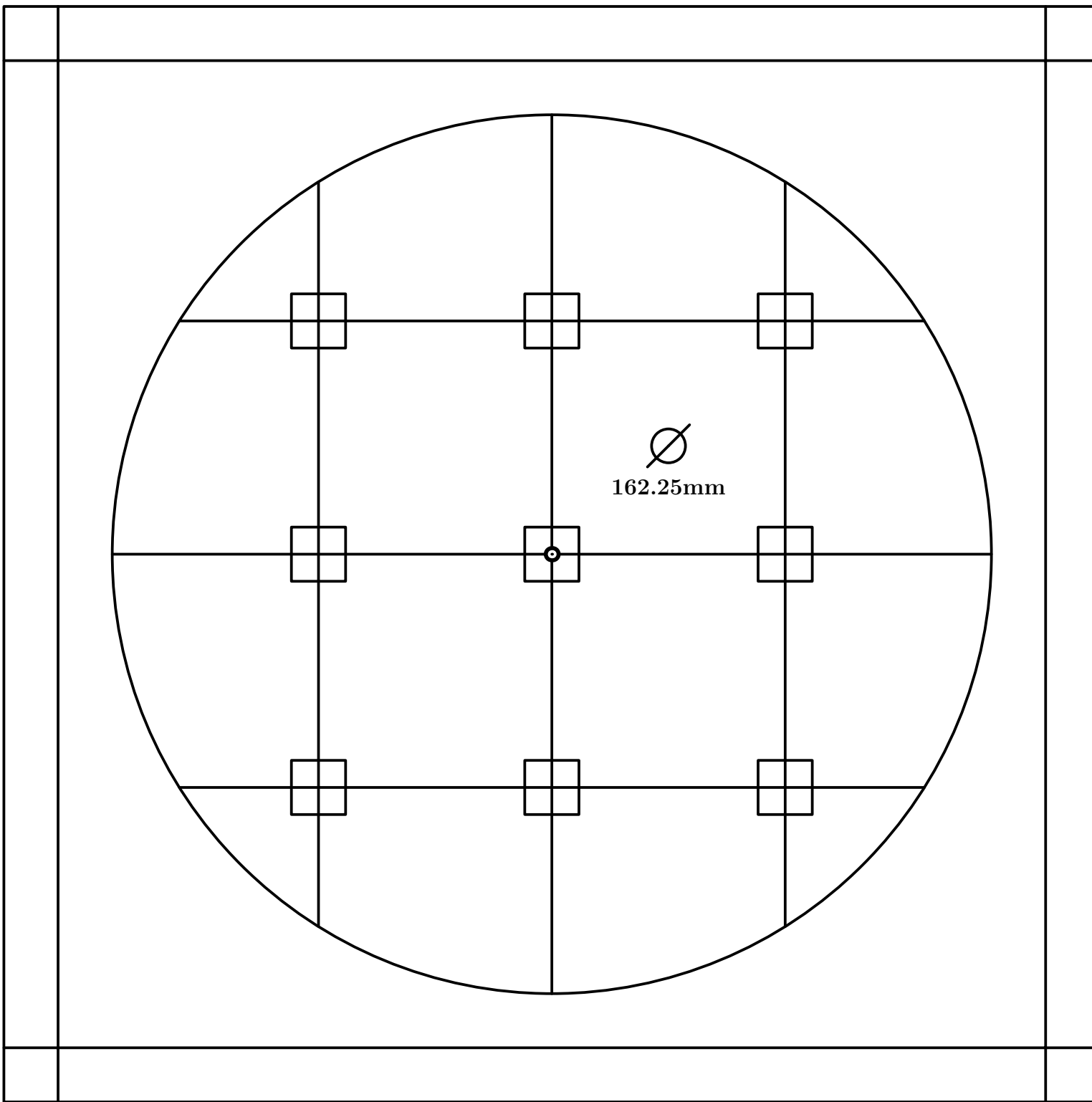

Fig. 250

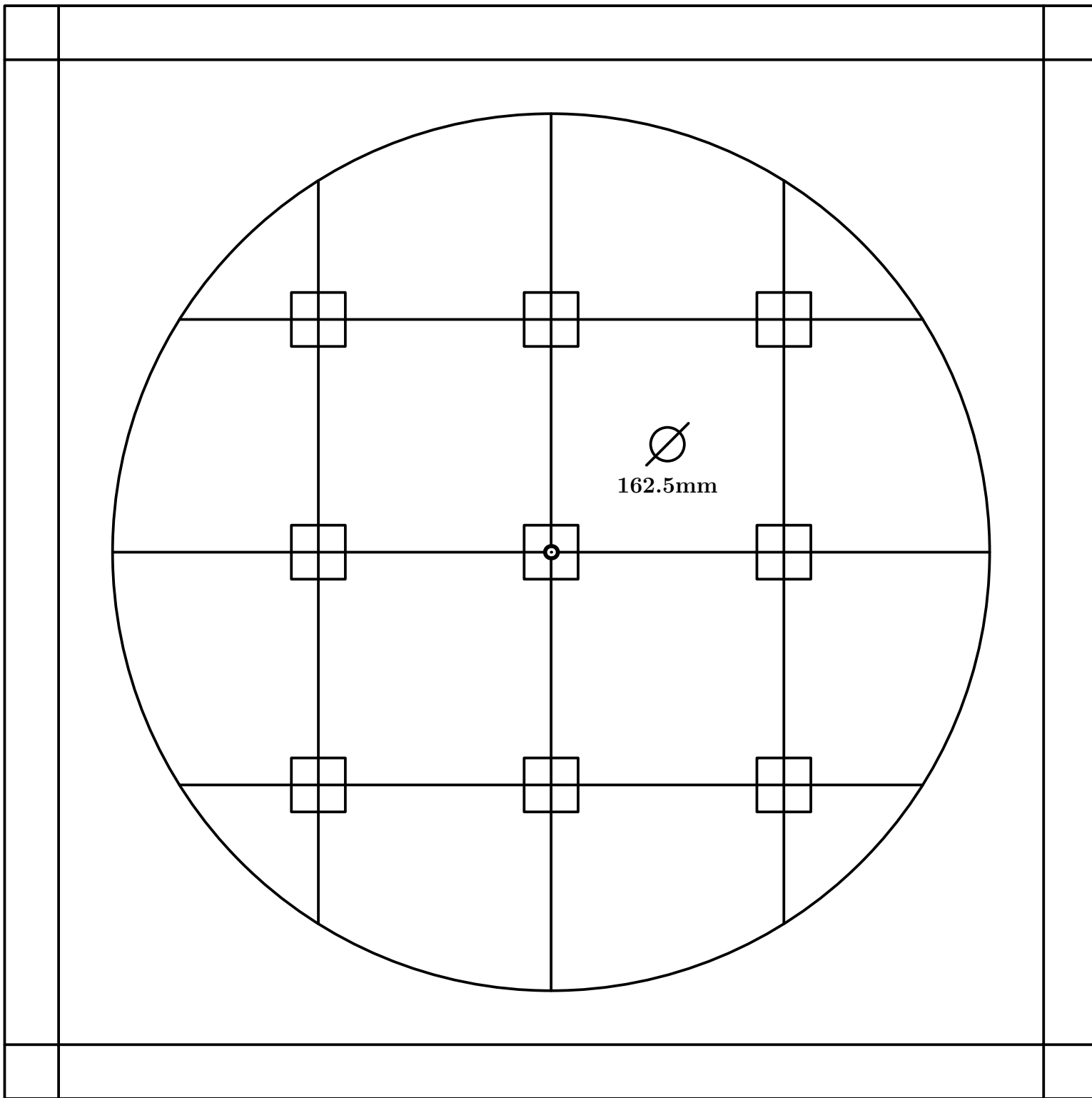

Fig. 251

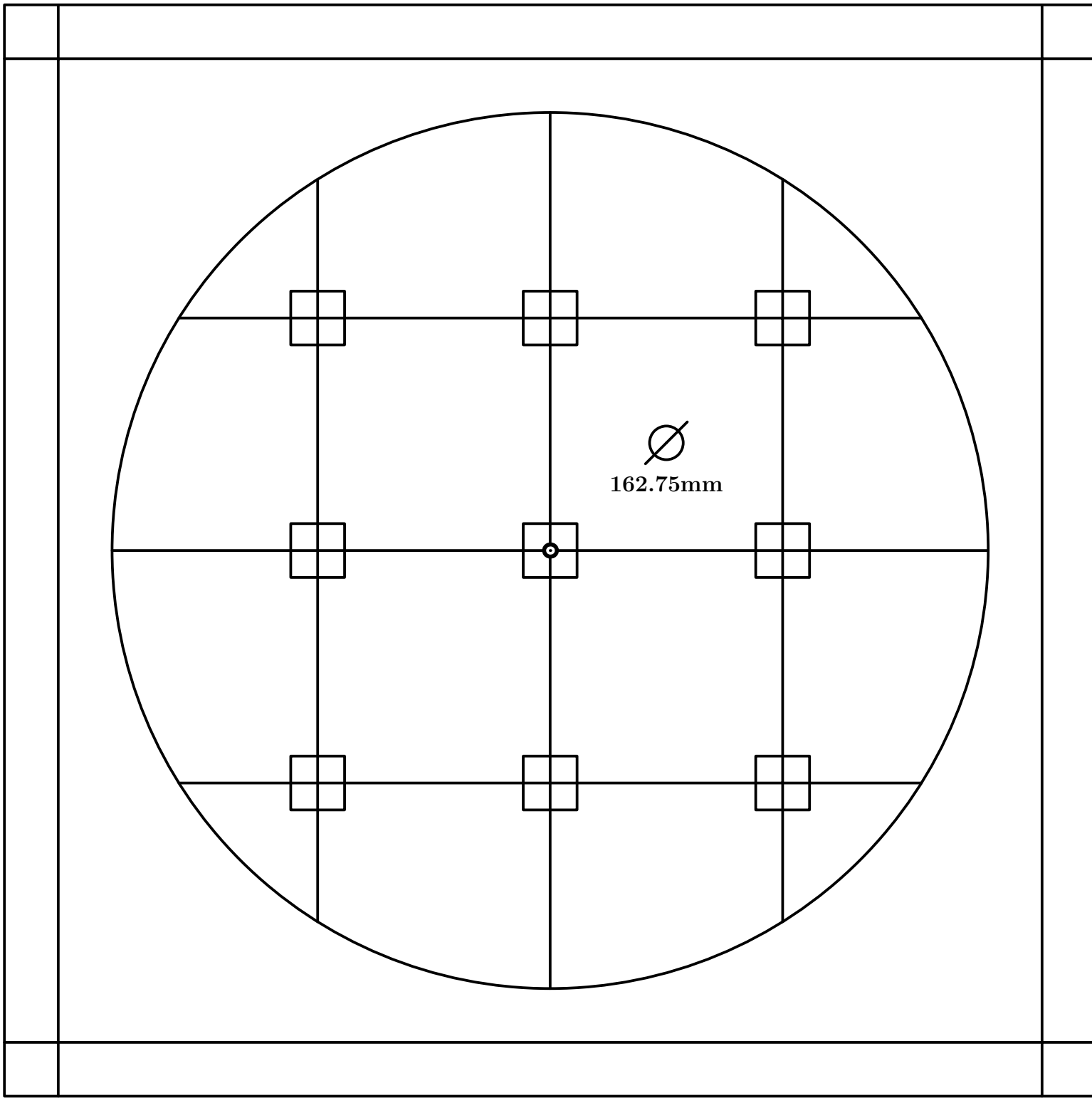

Fig. 252

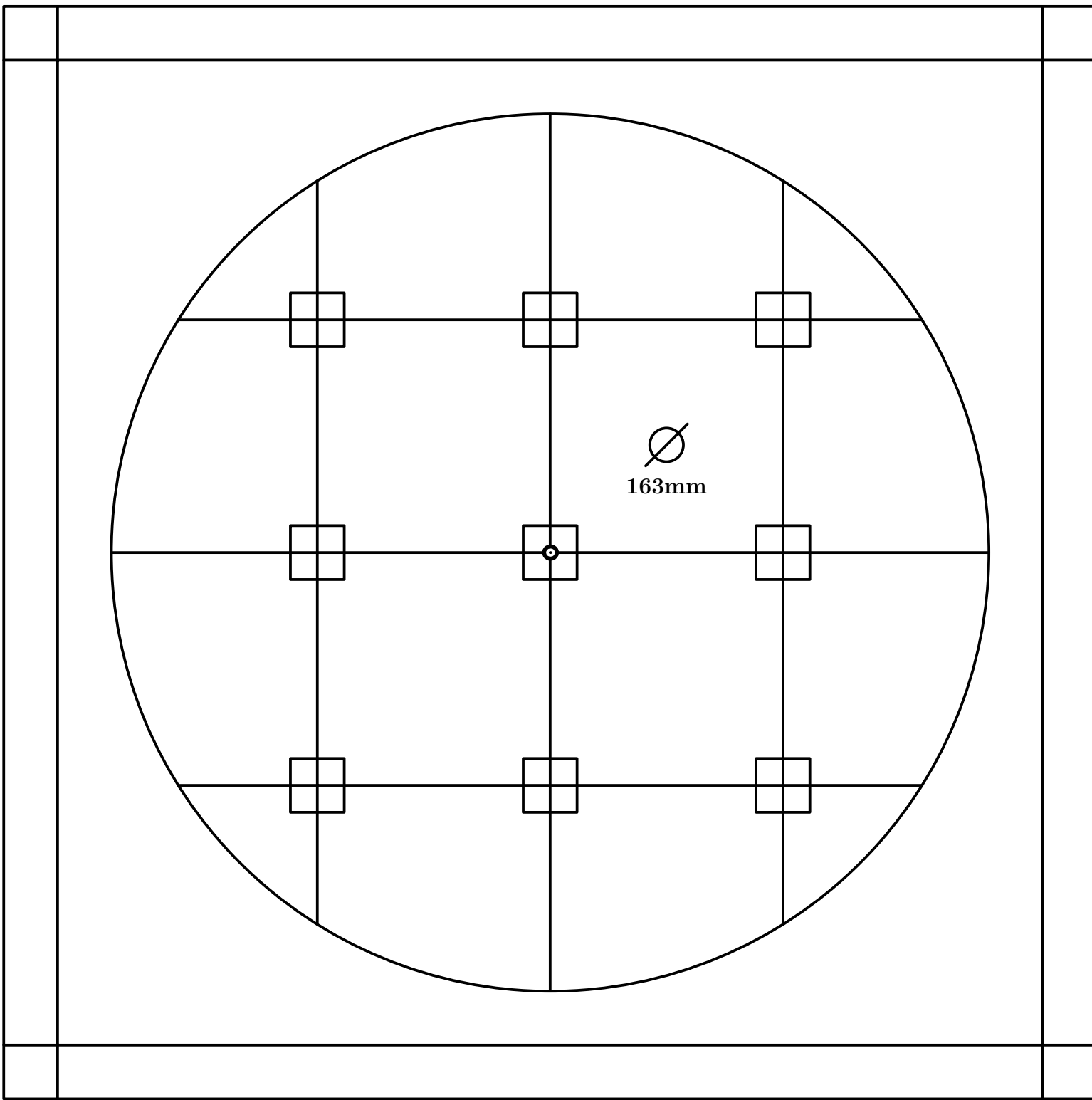

Fig. 253

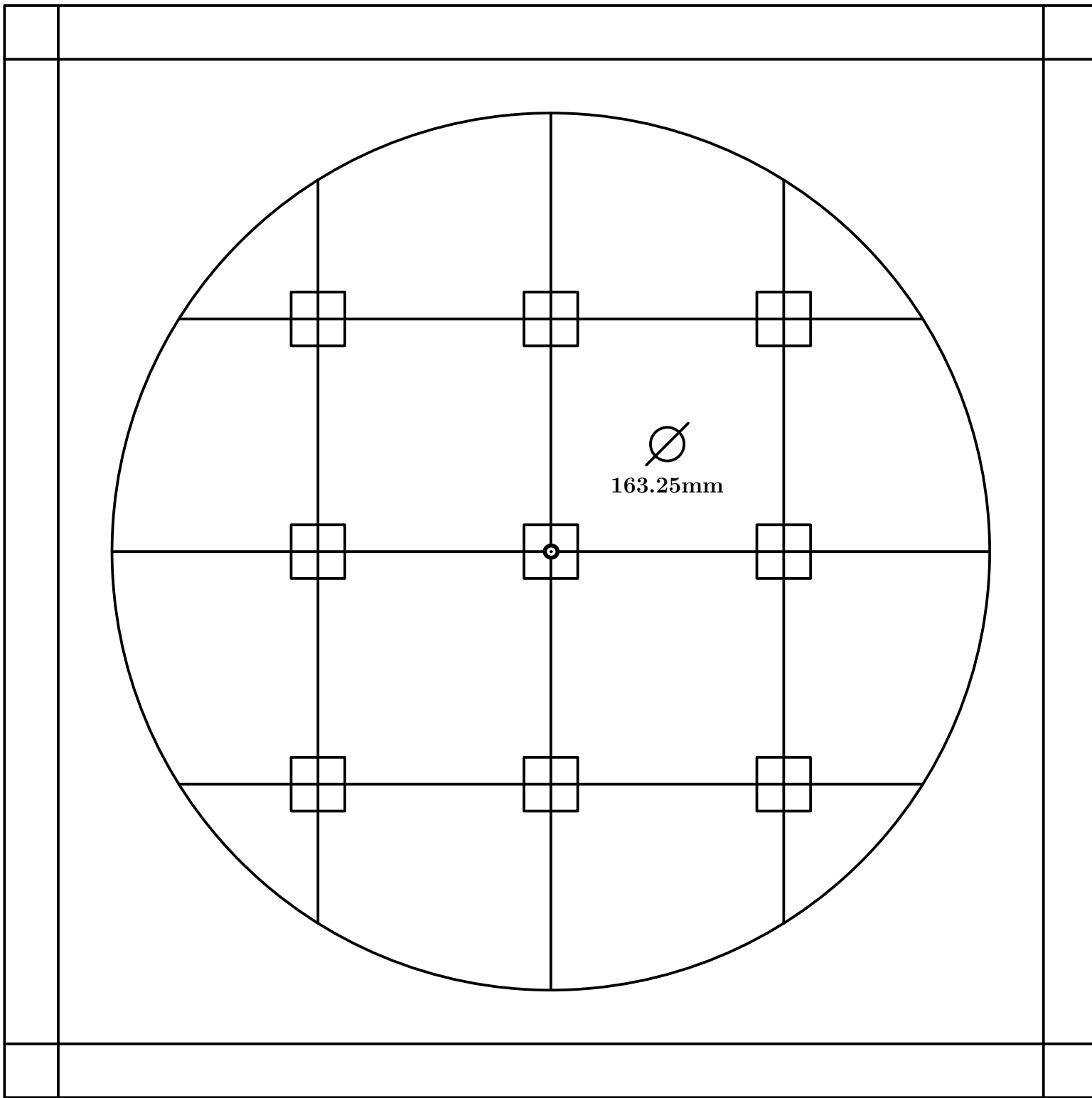

Fig. 254

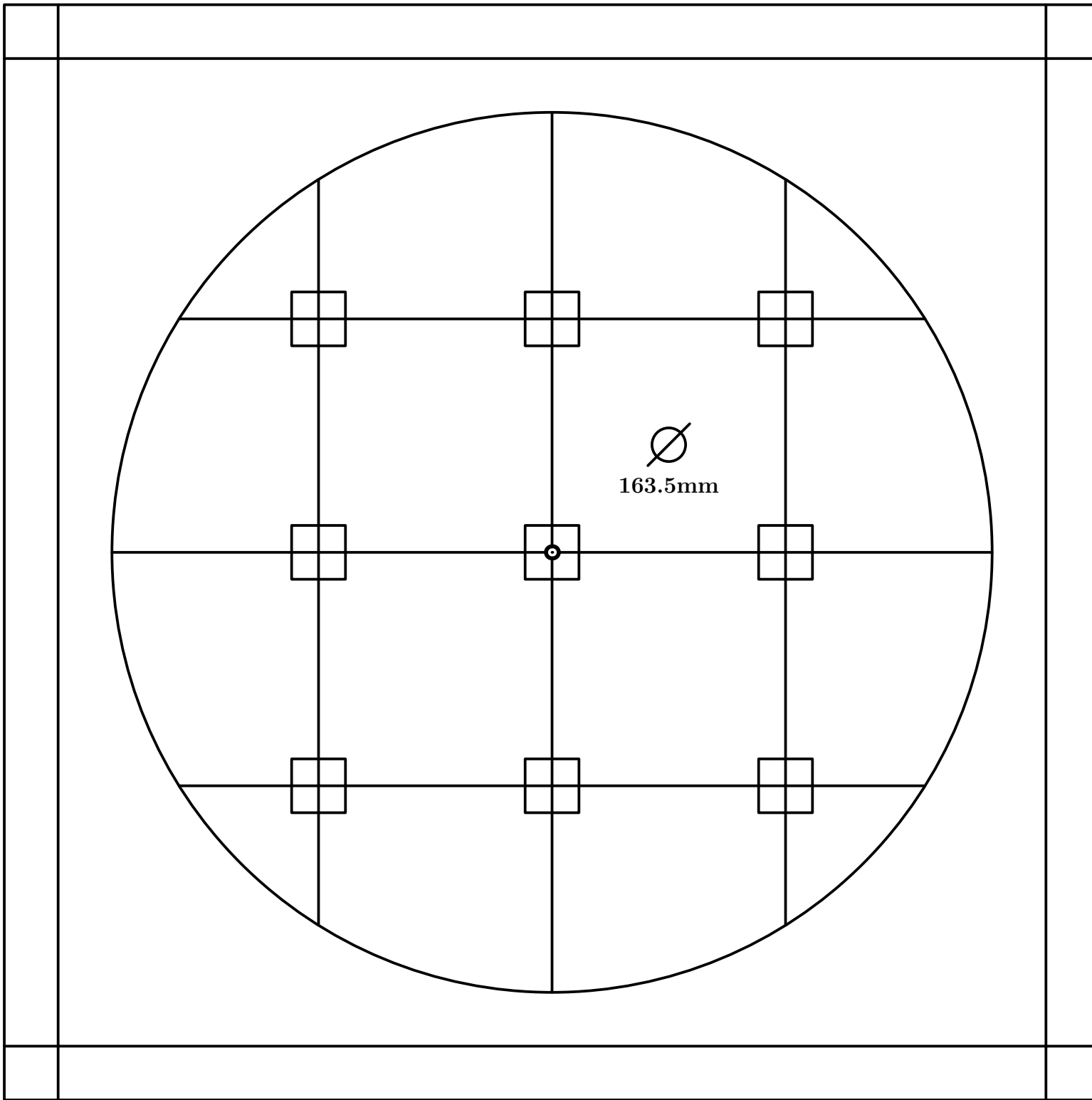

Fig. 255

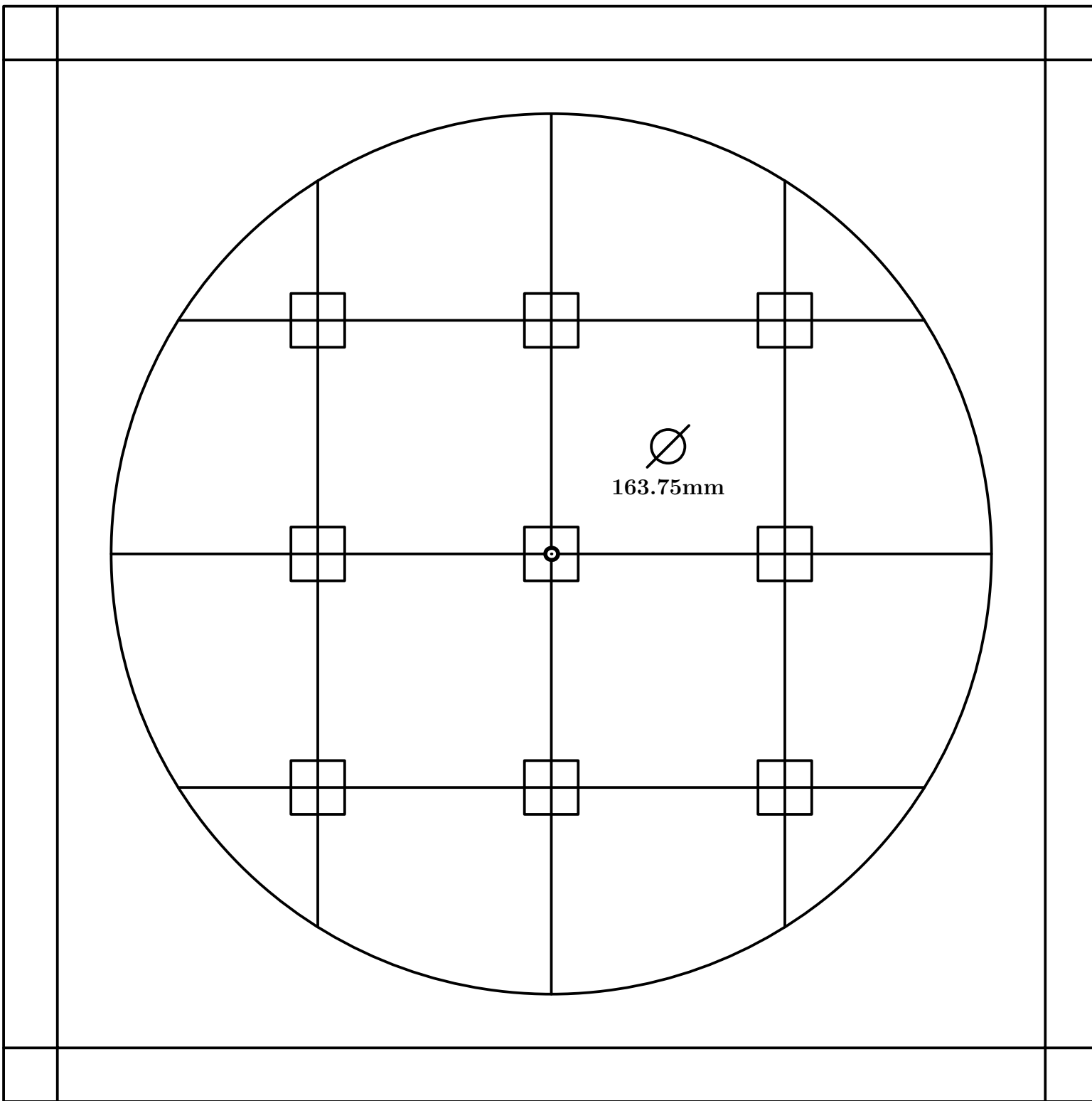

Fig. 256

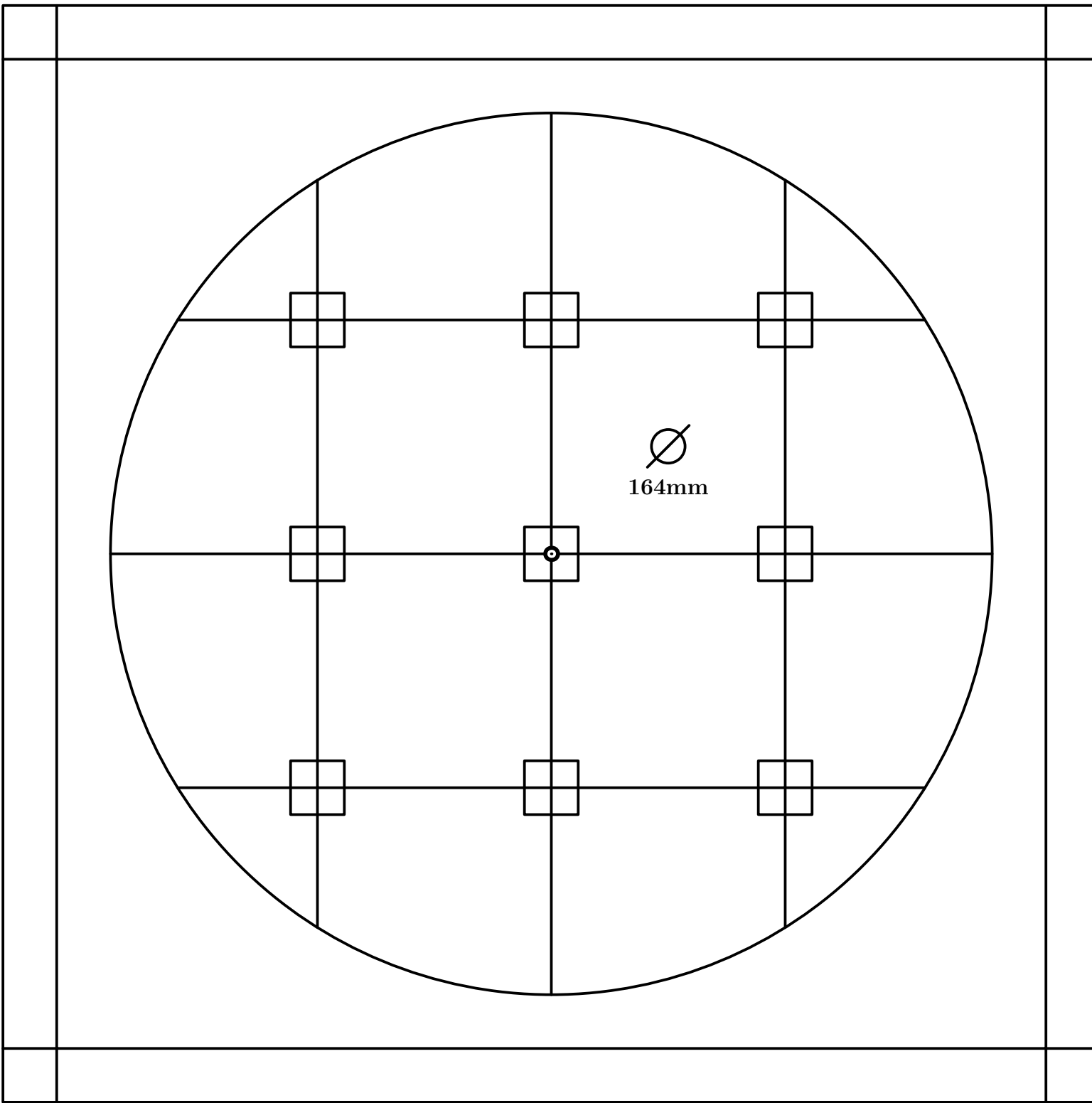

Fig. 257

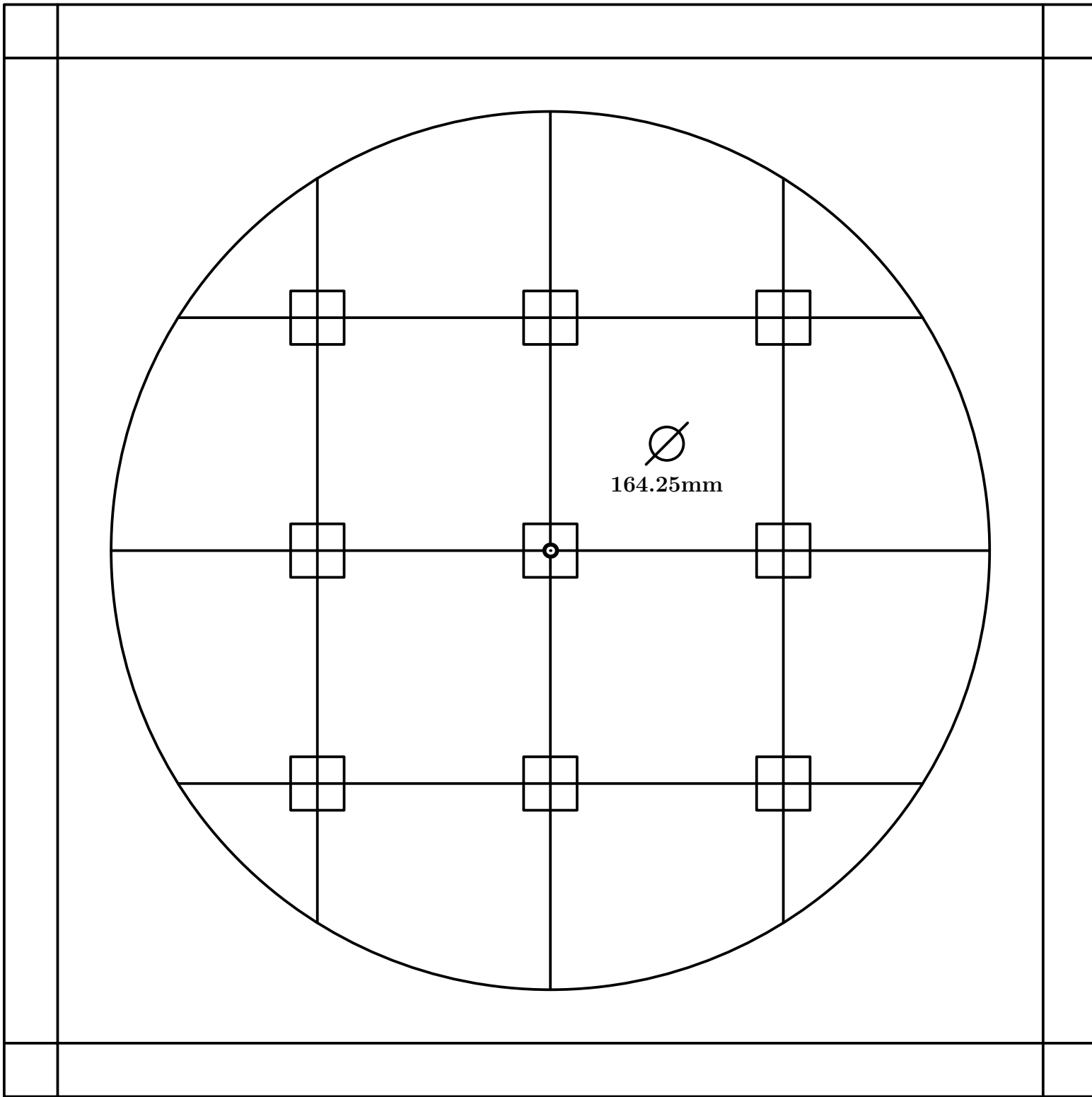

Fig. 258

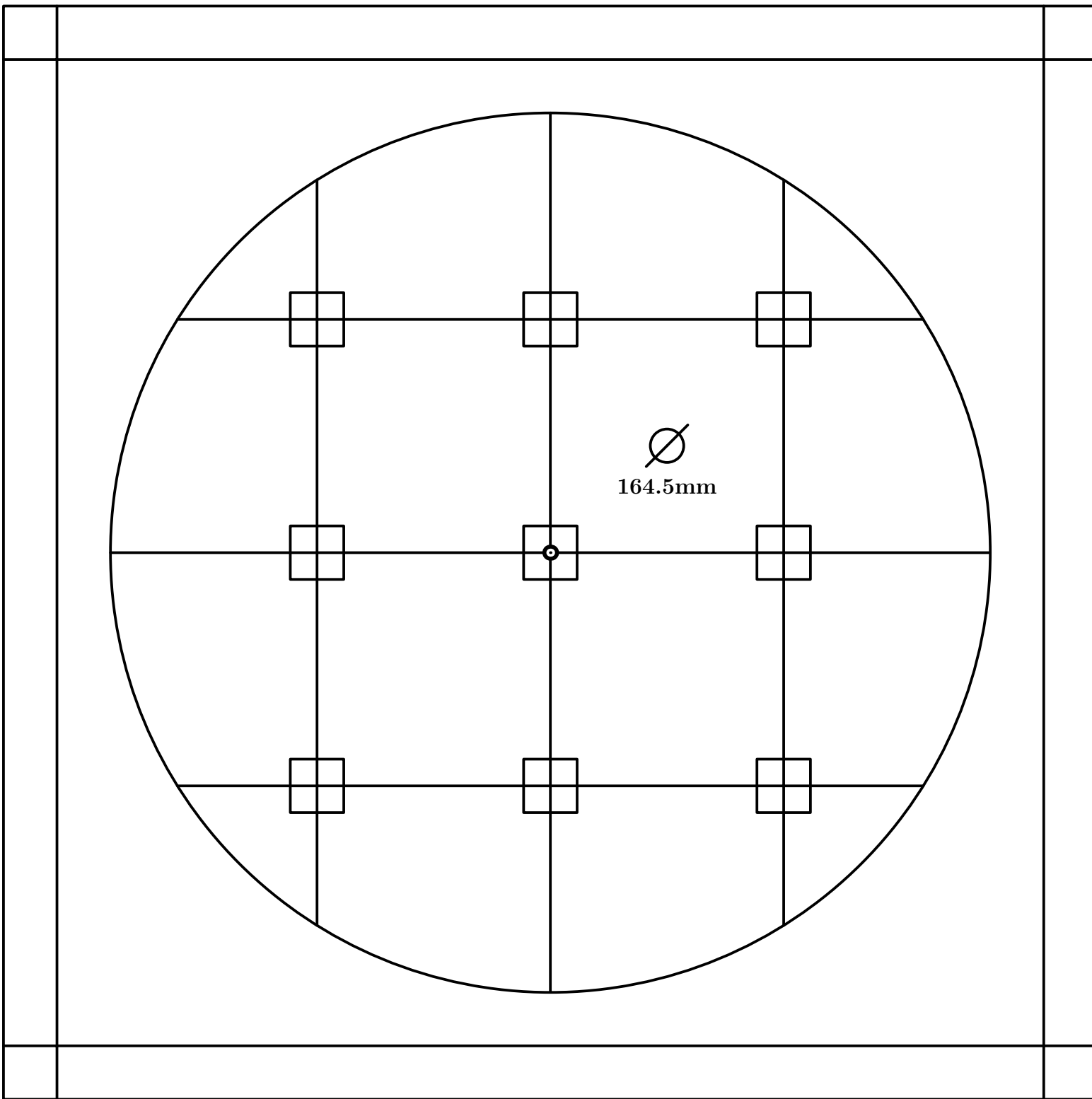

Fig. 259

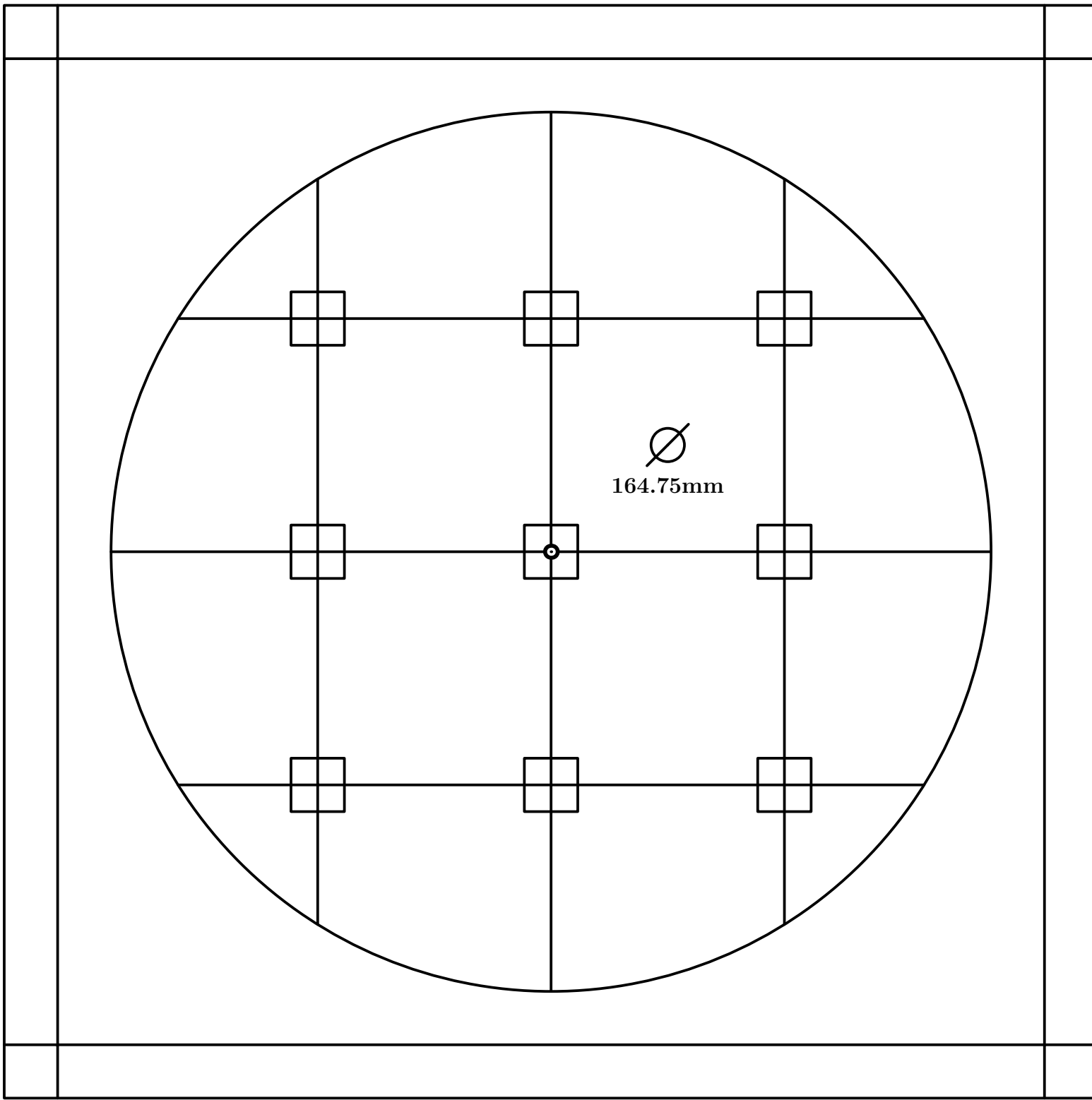

Fig. 260

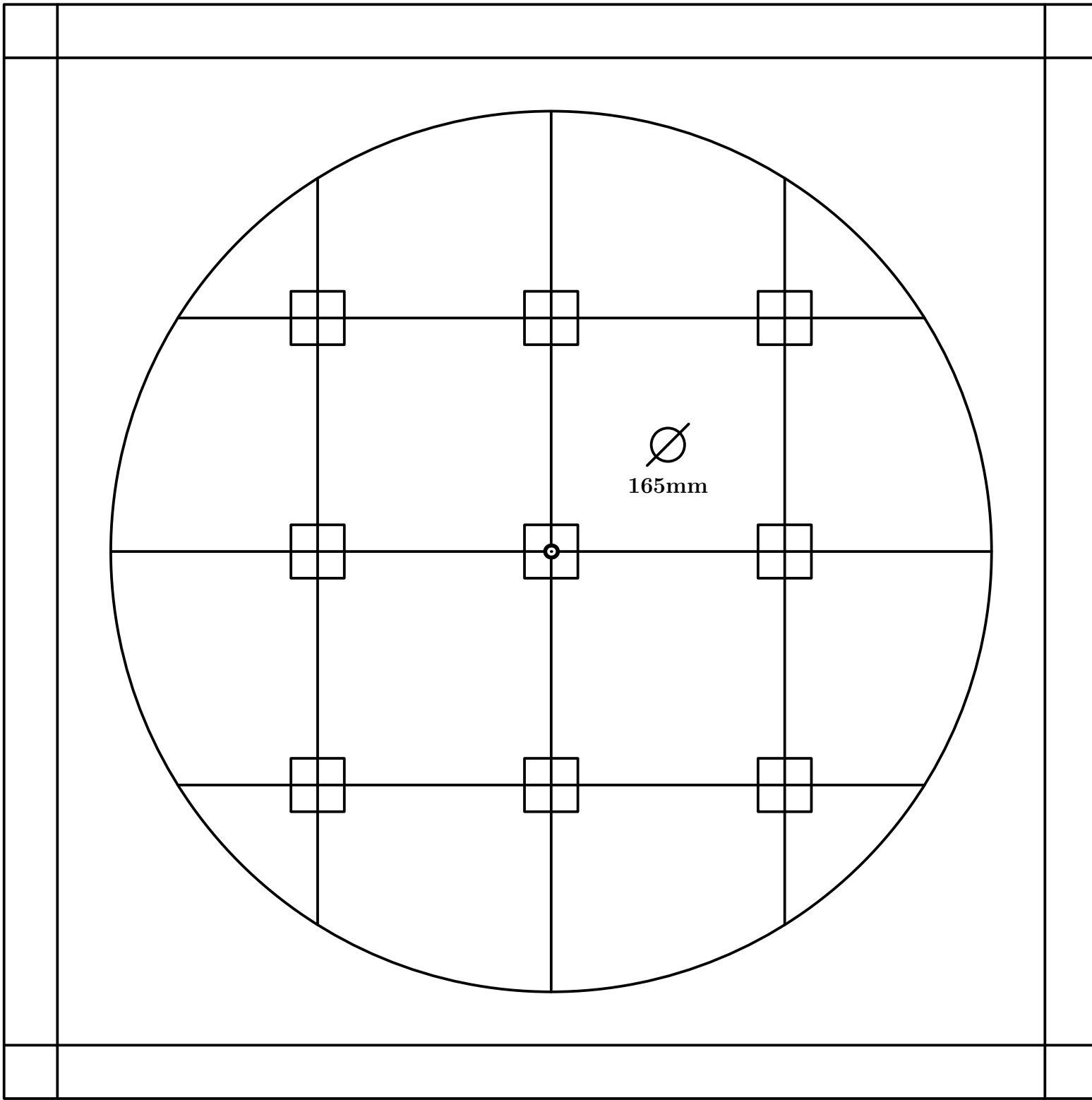

Fig. 261

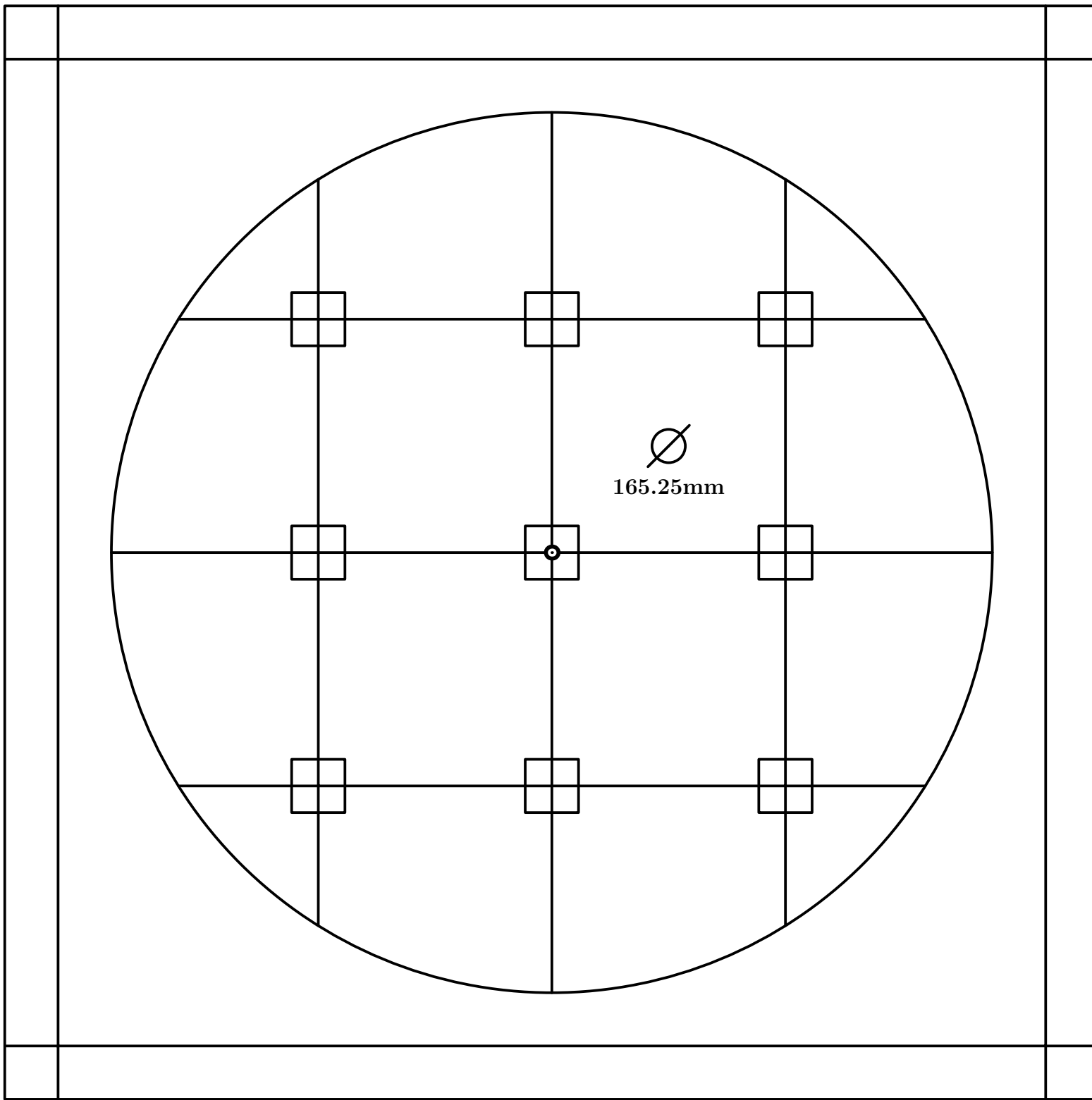

Fig. 262

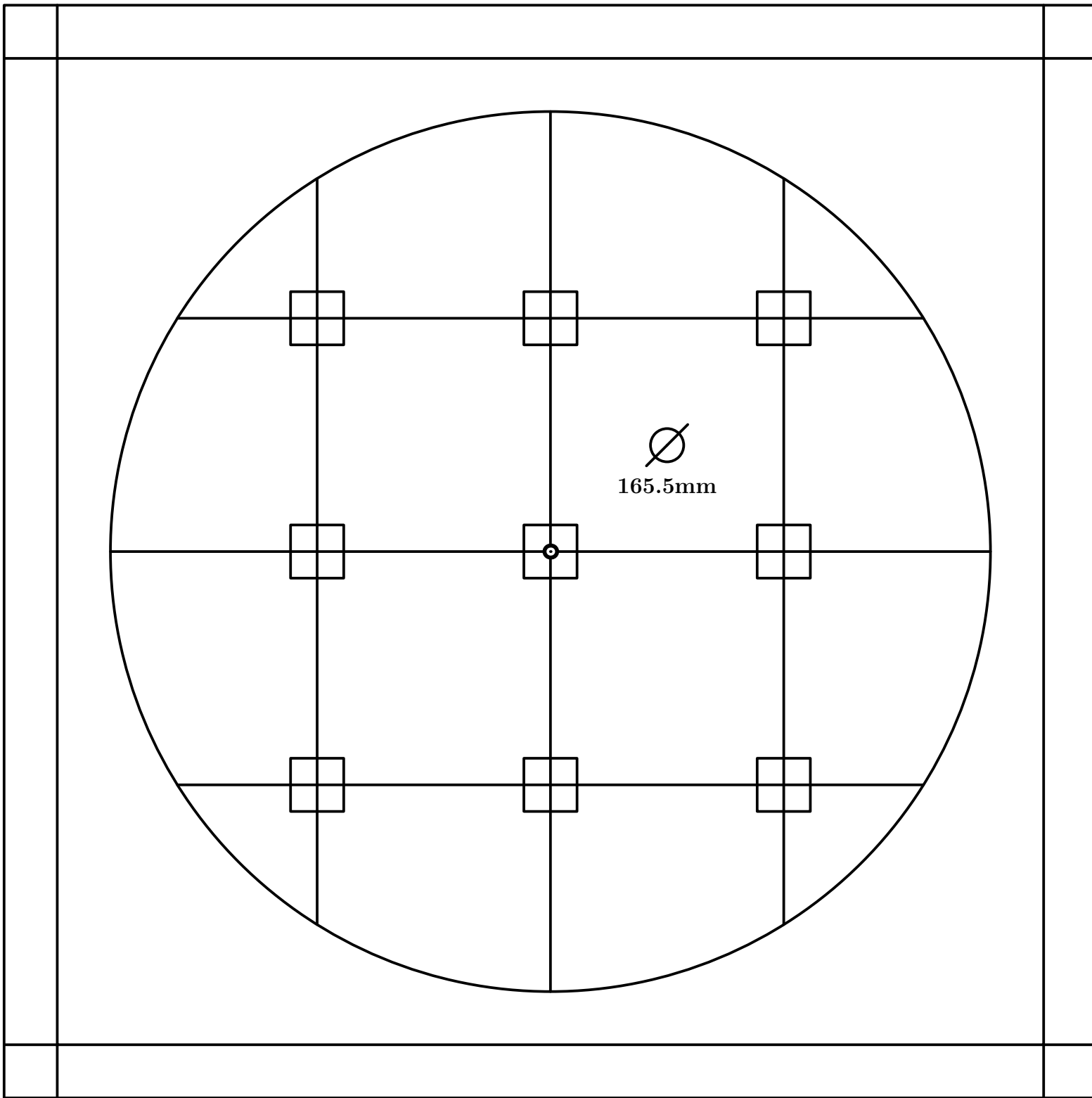

Fig. 263

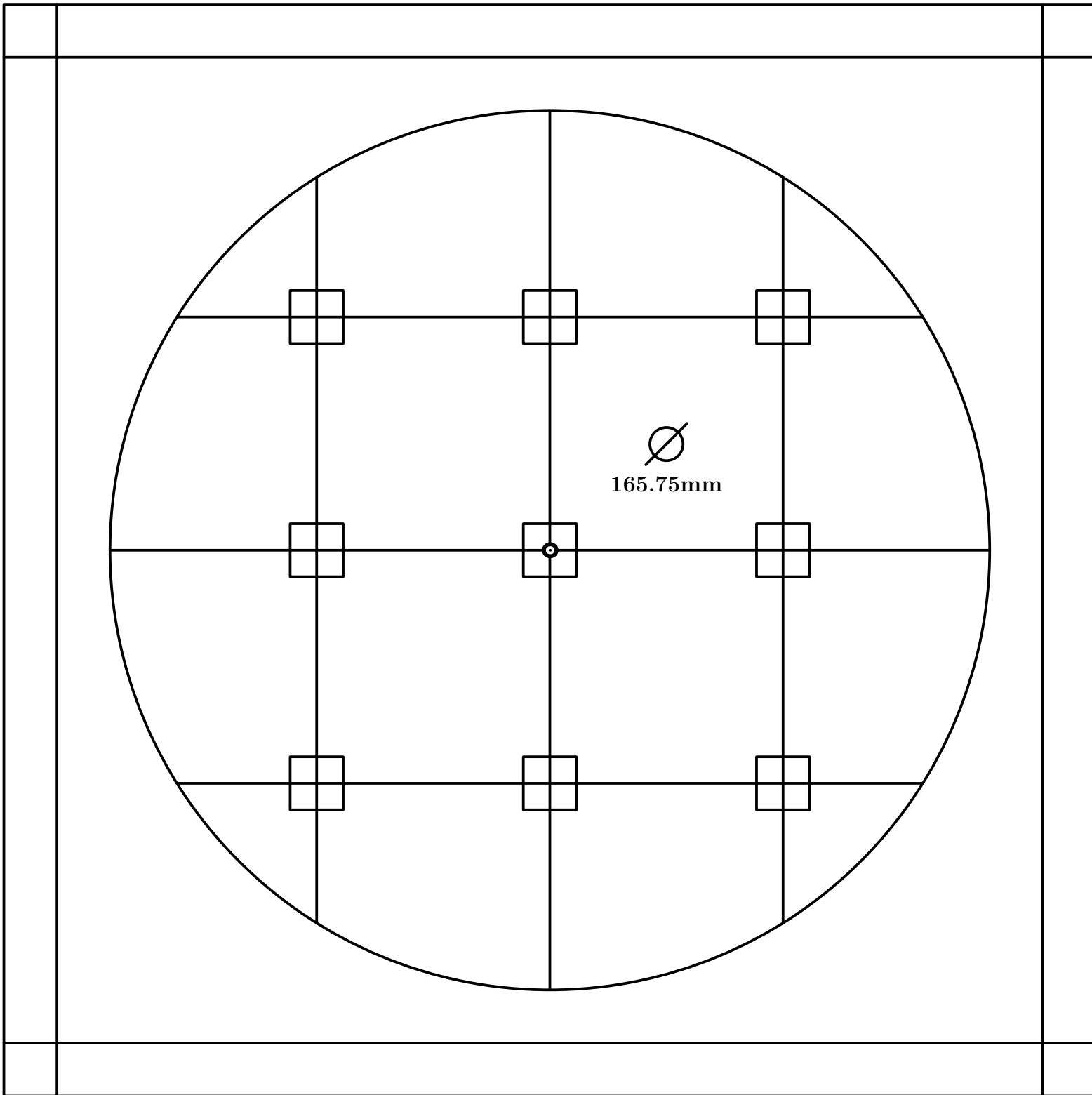

Fig. 264

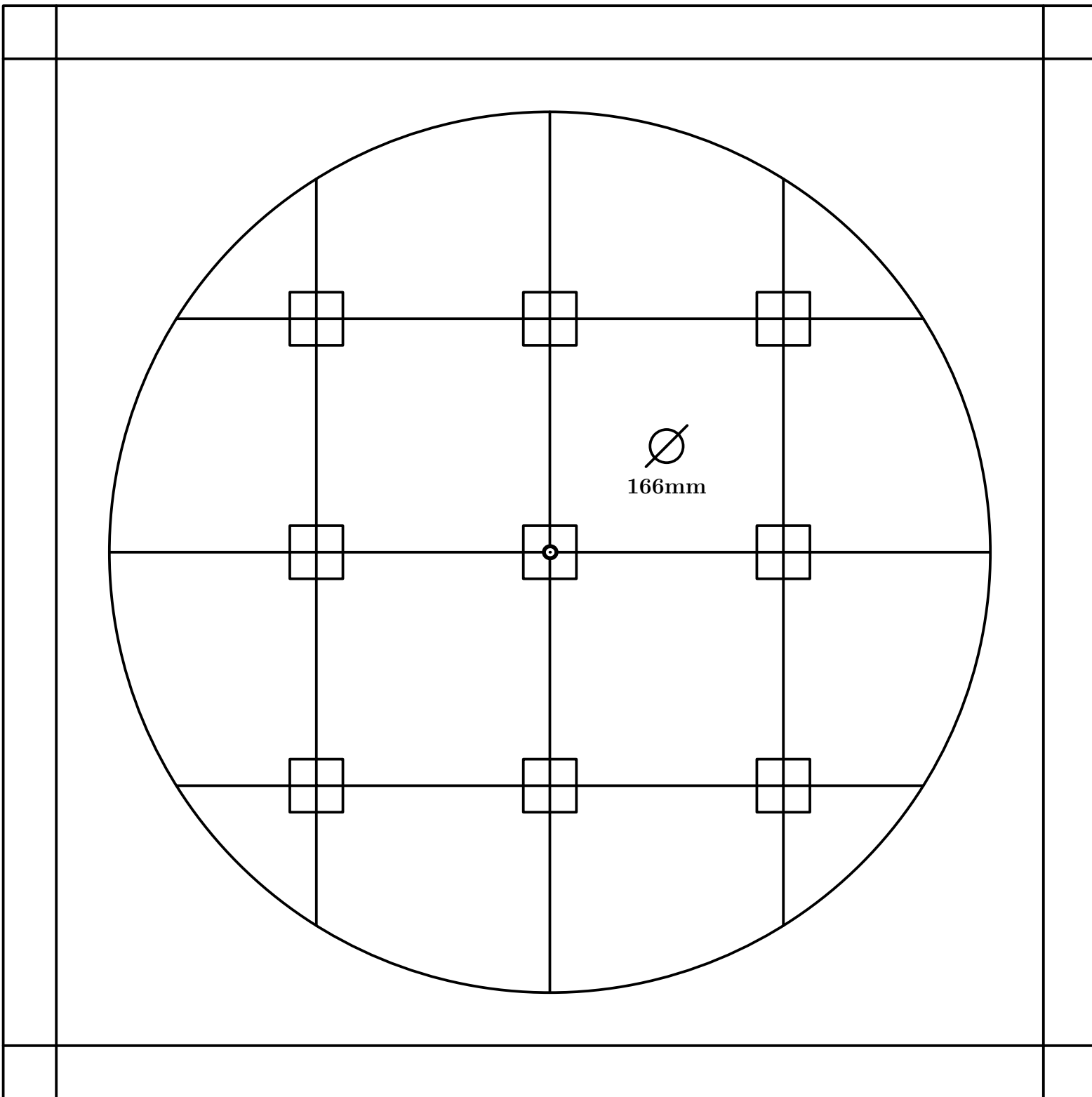

Fig. 265

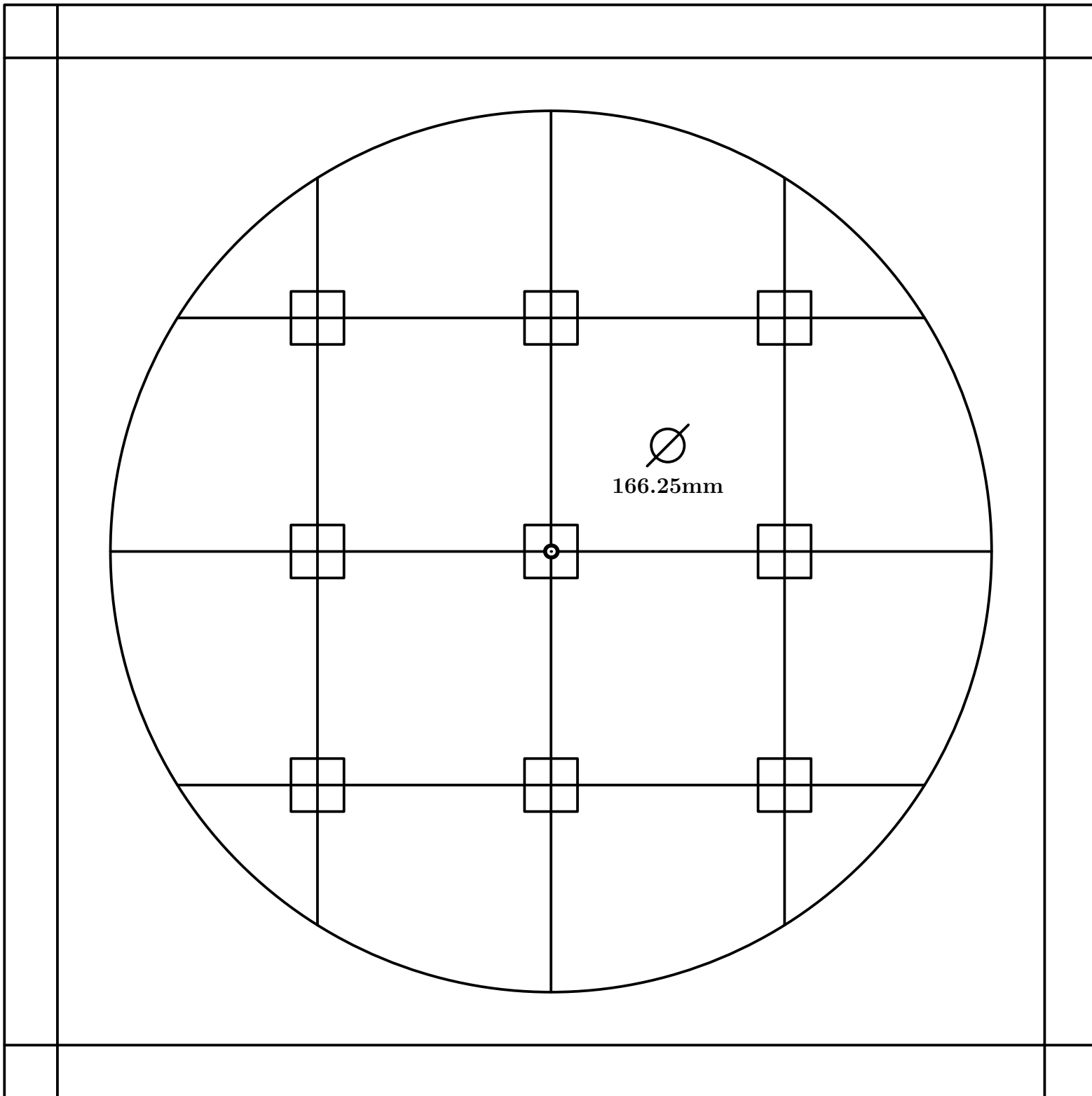

Fig. 266

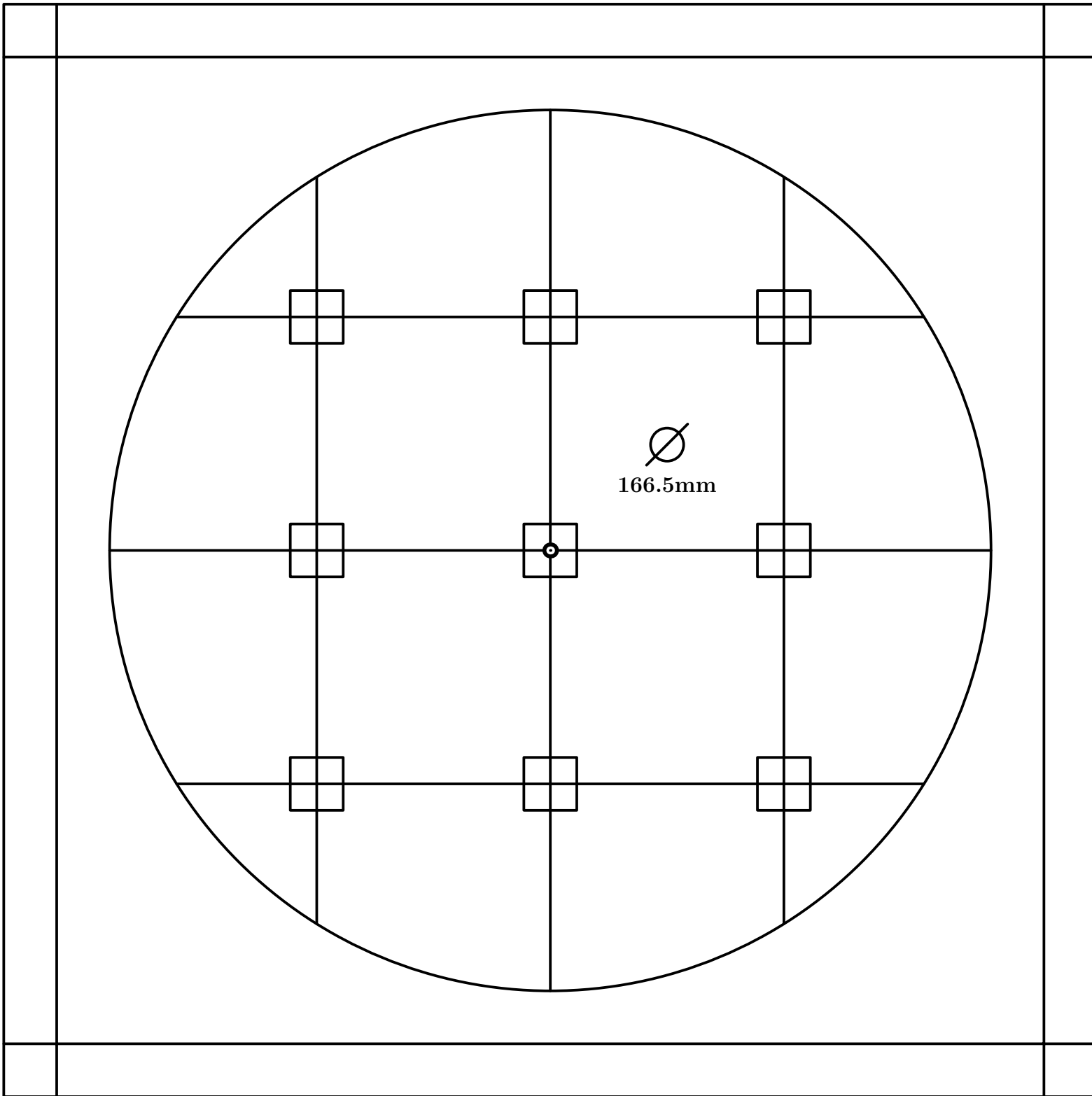

Fig. 267

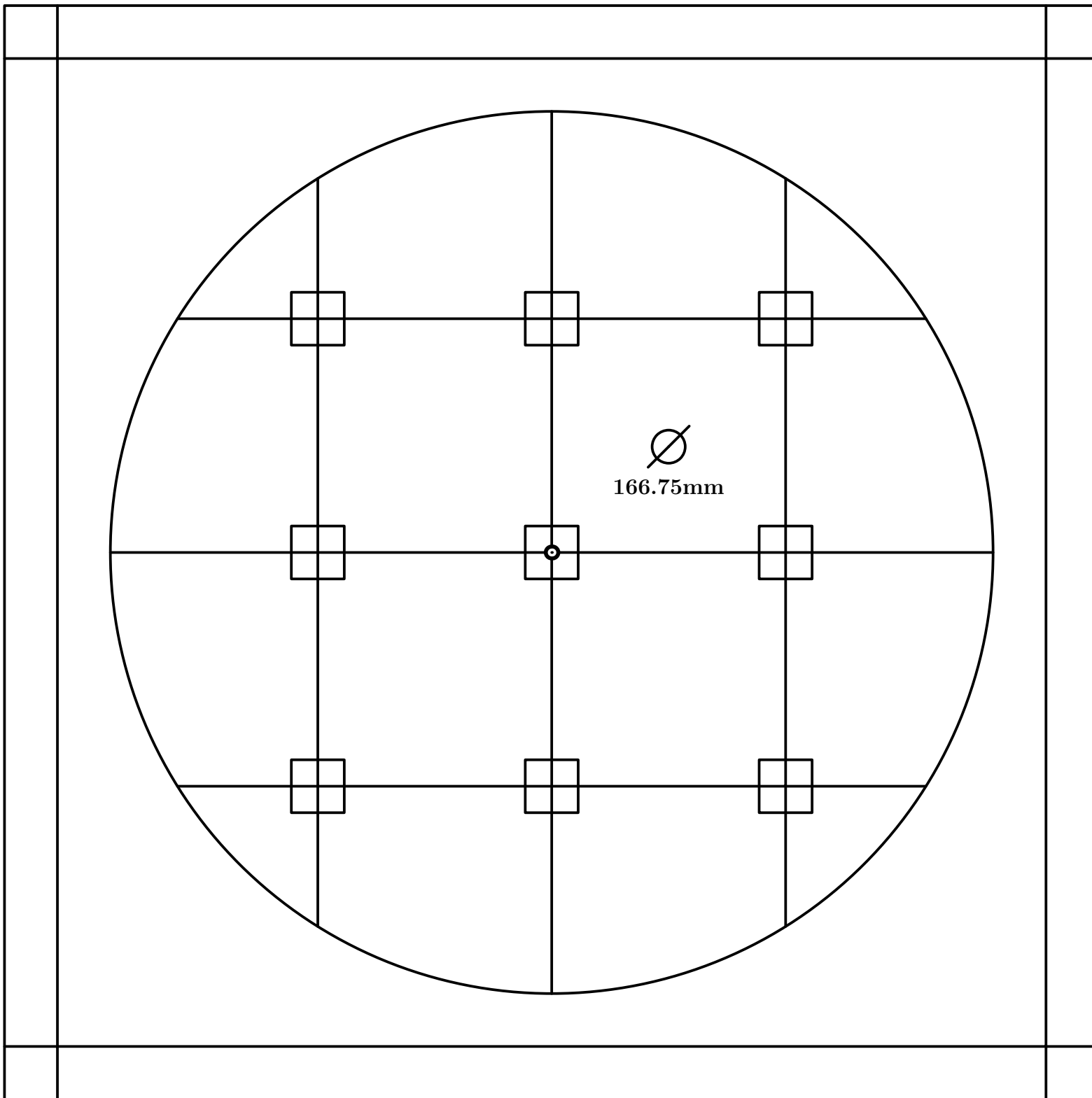

Fig. 268

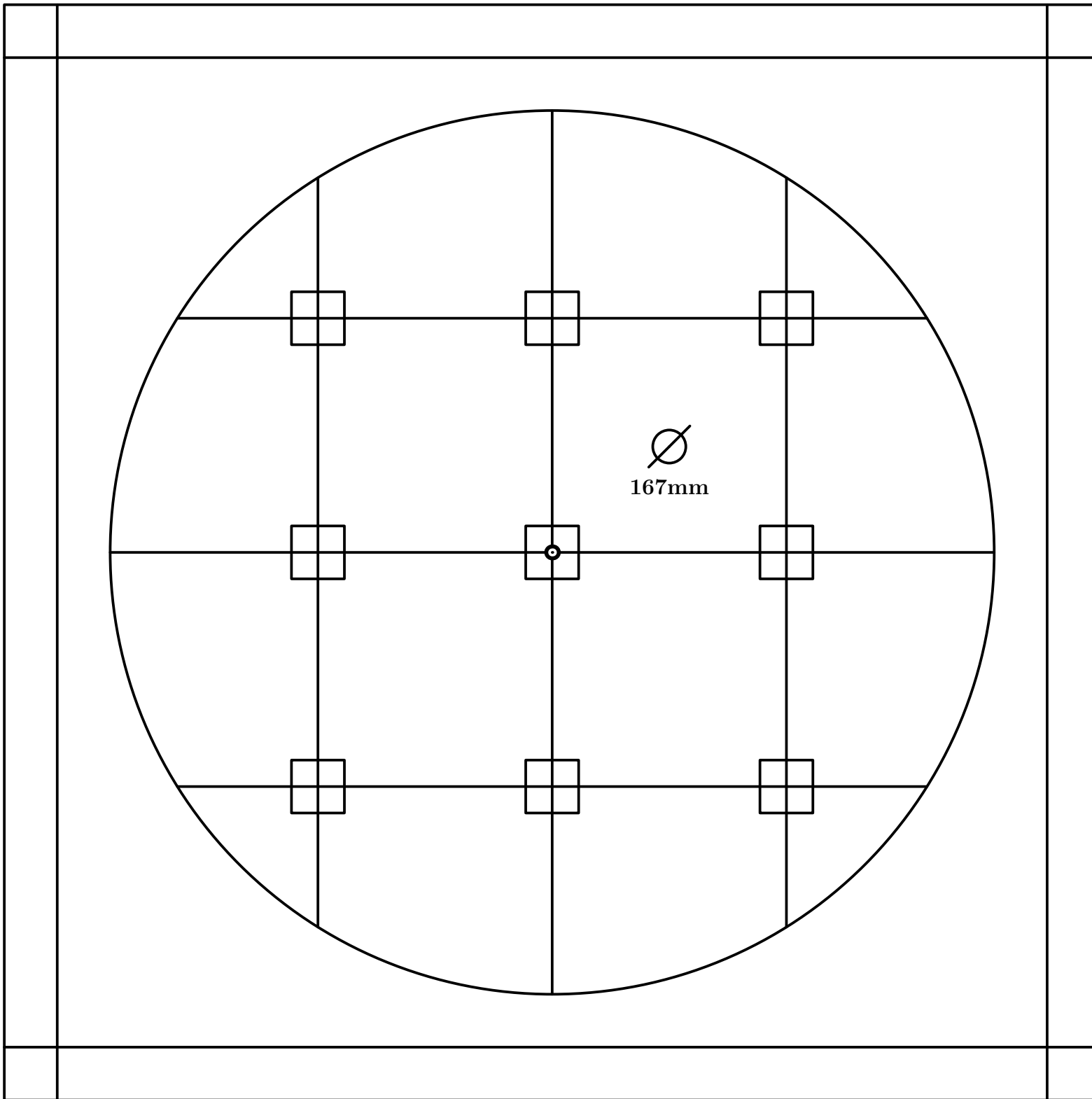

Fig. 269

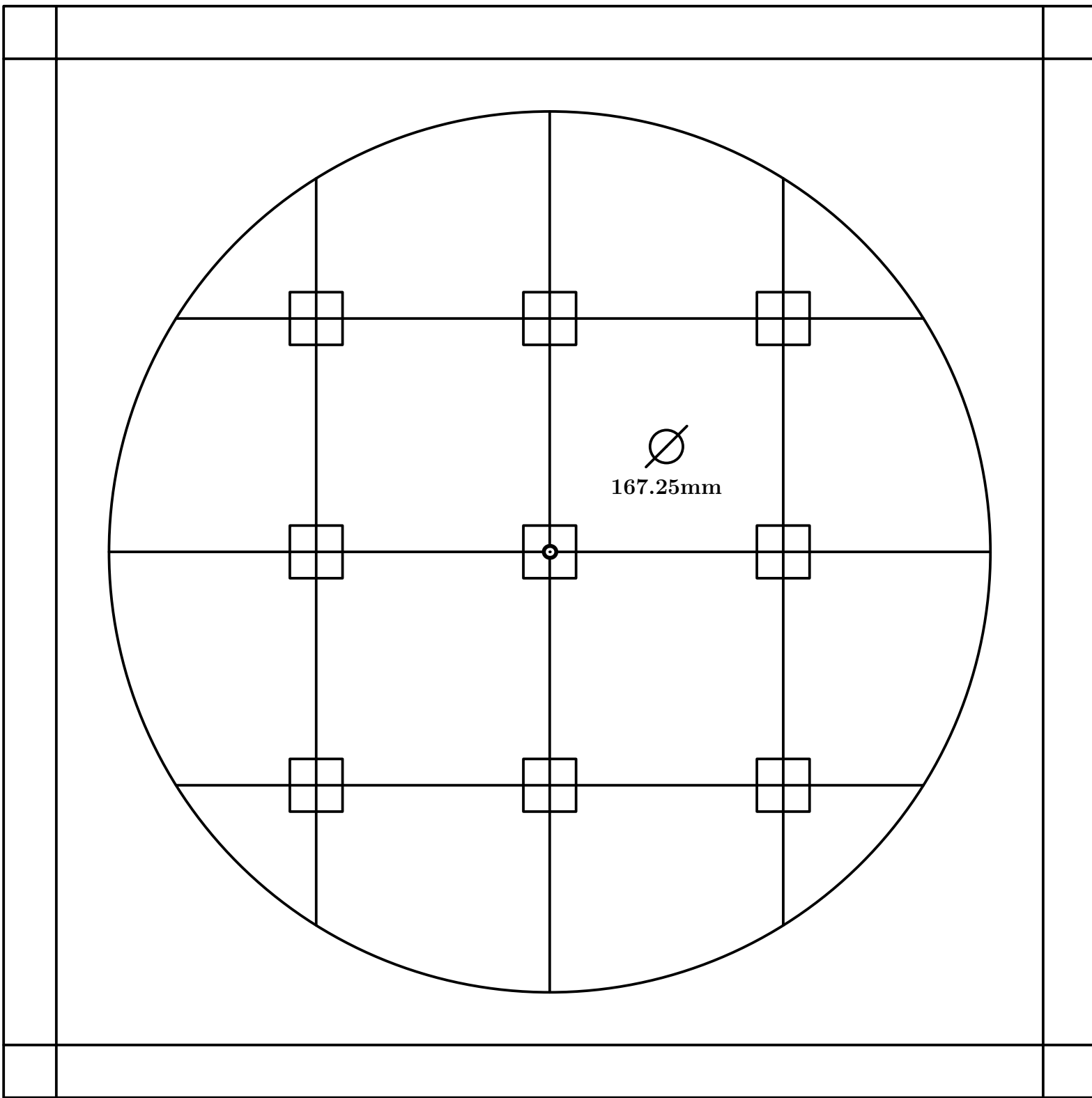

Fig. 270

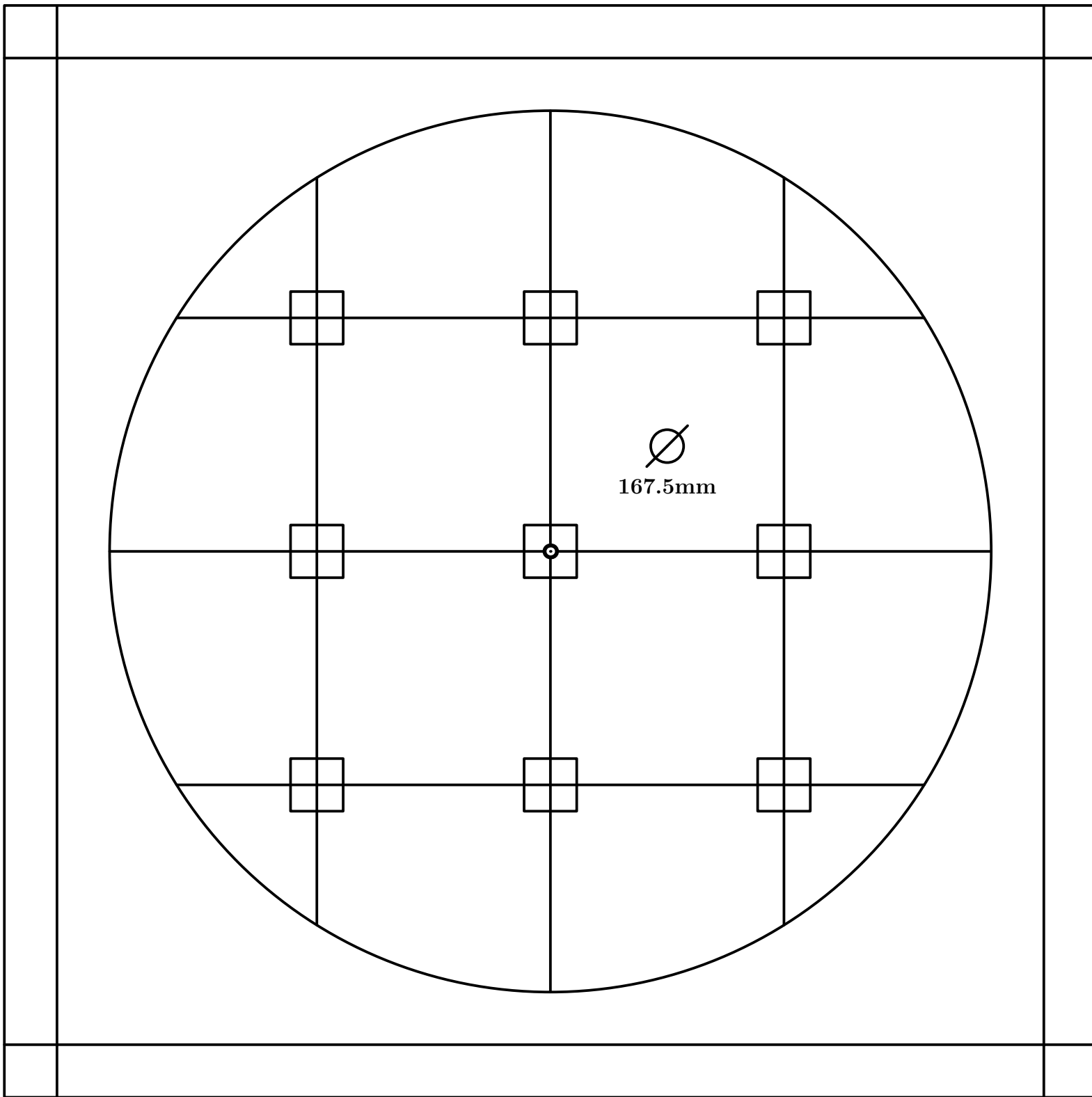

Fig. 271

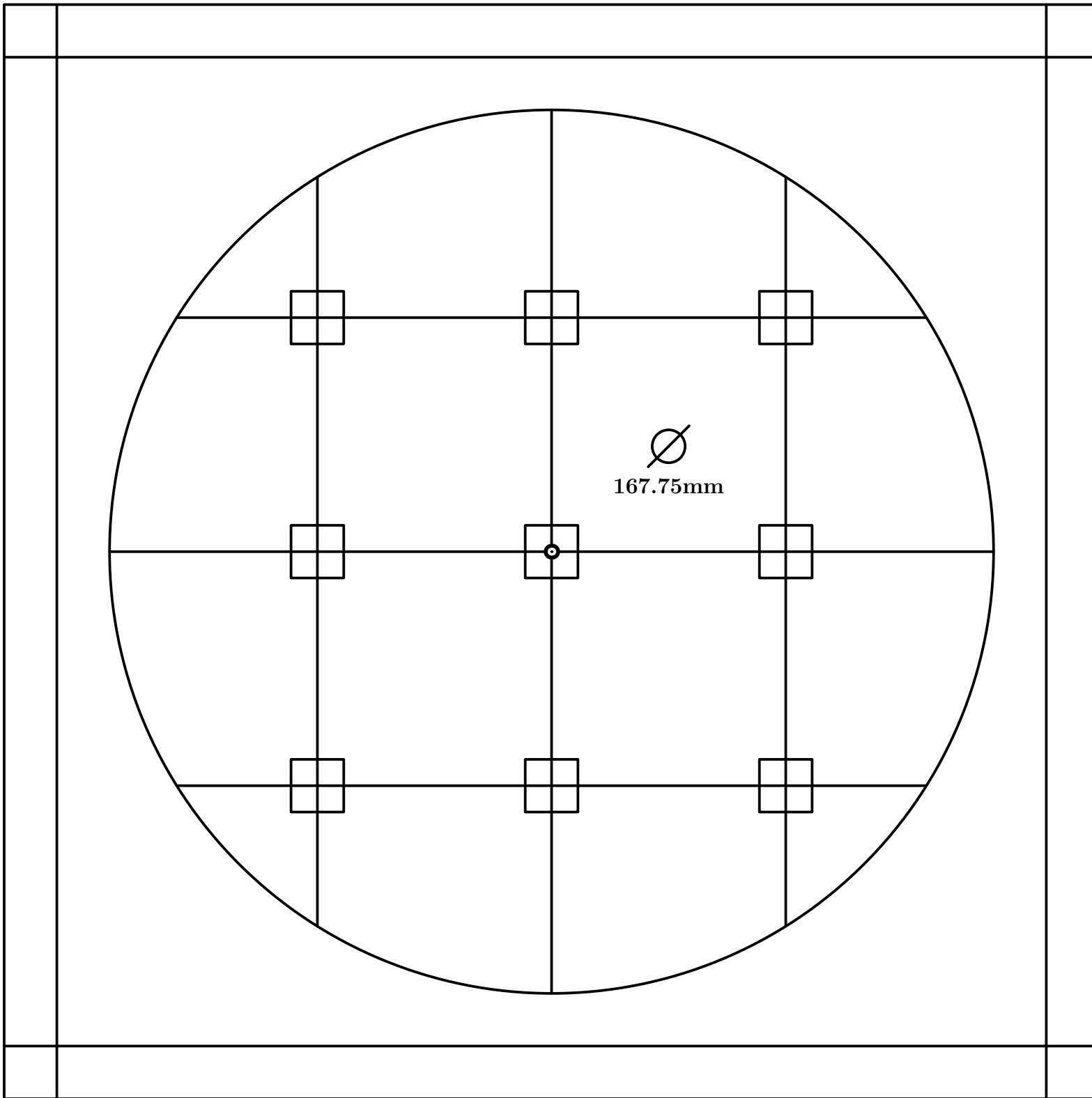

Fig. 272

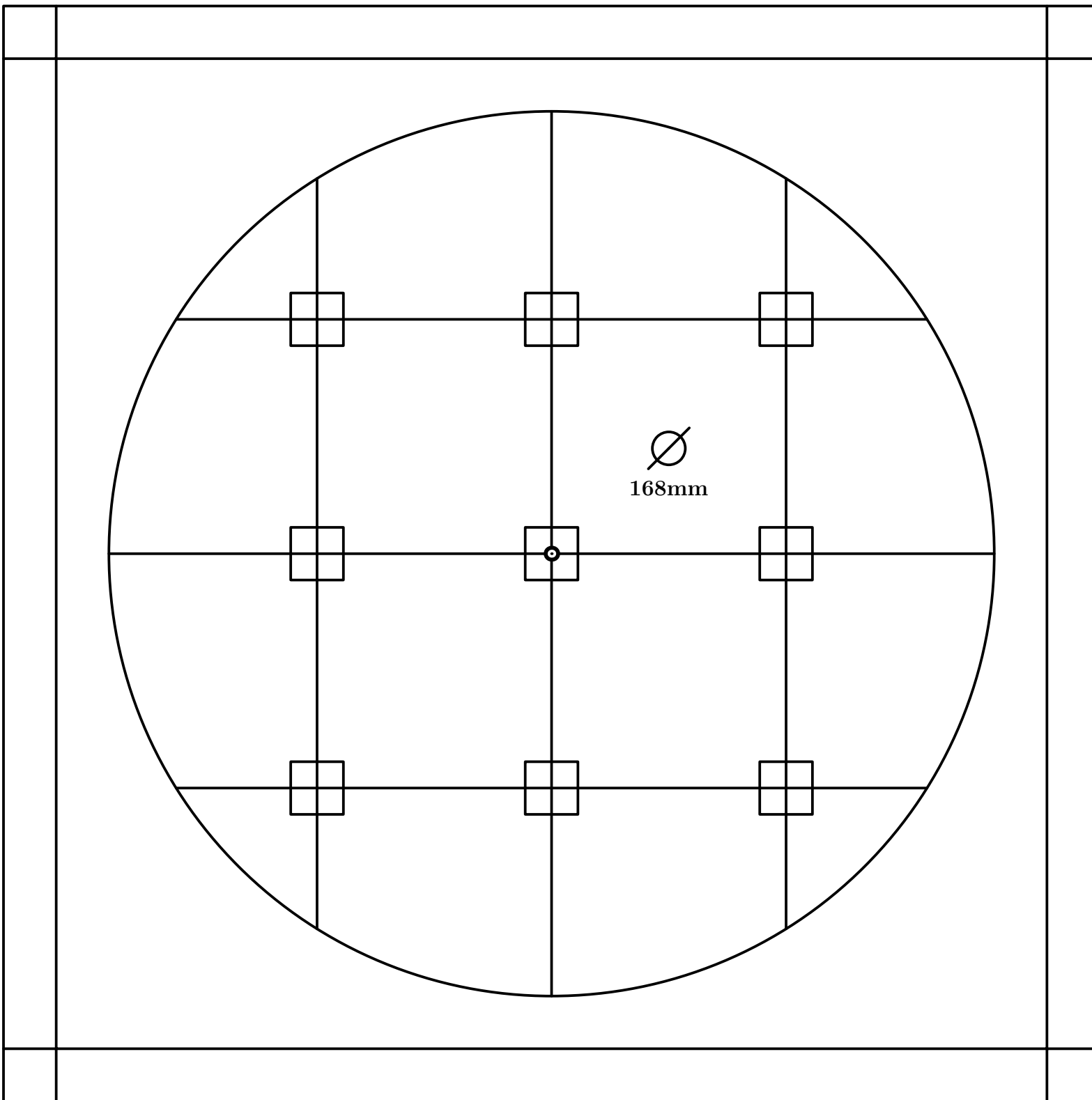

Fig. 273

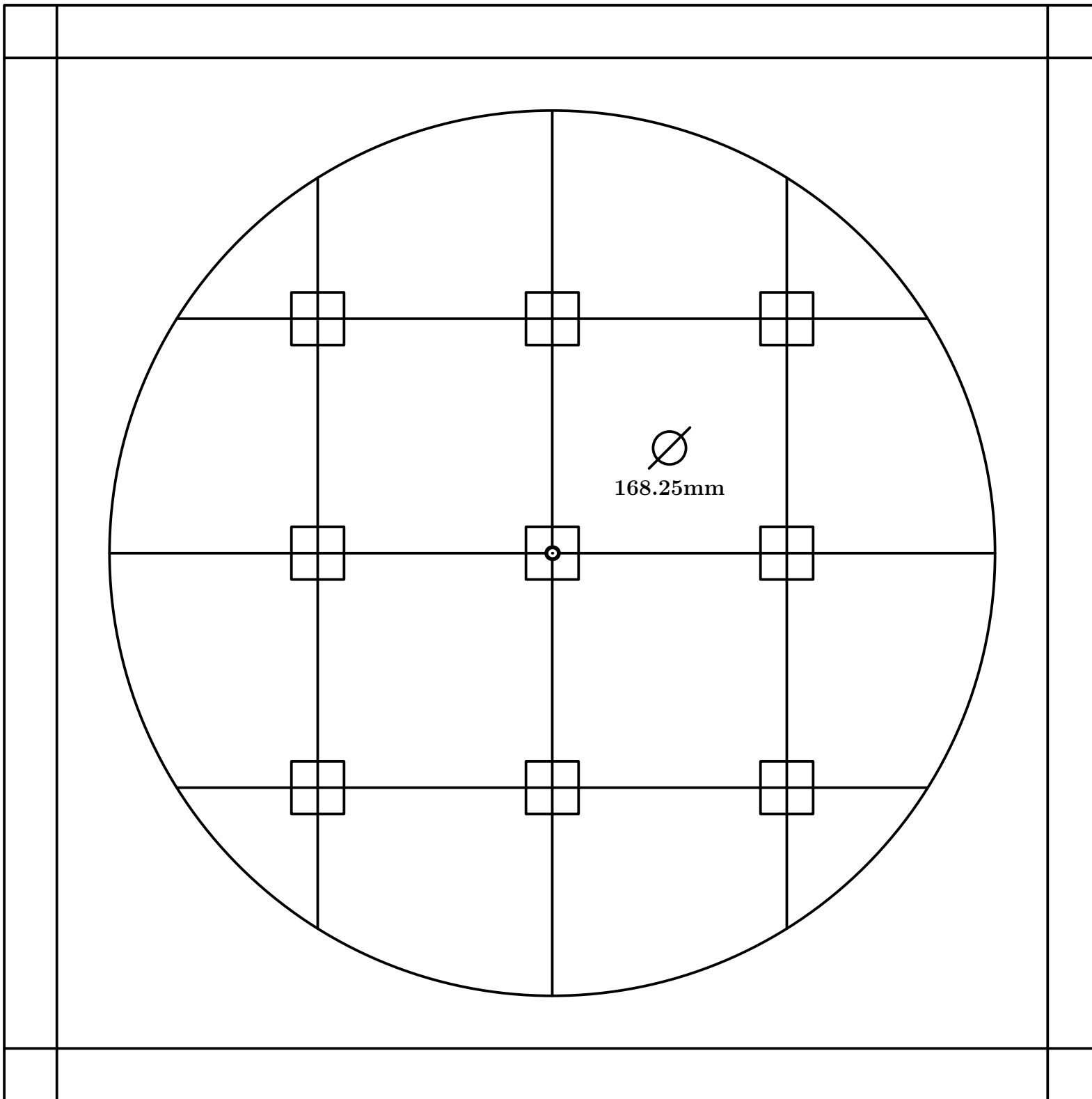

Fig. 274

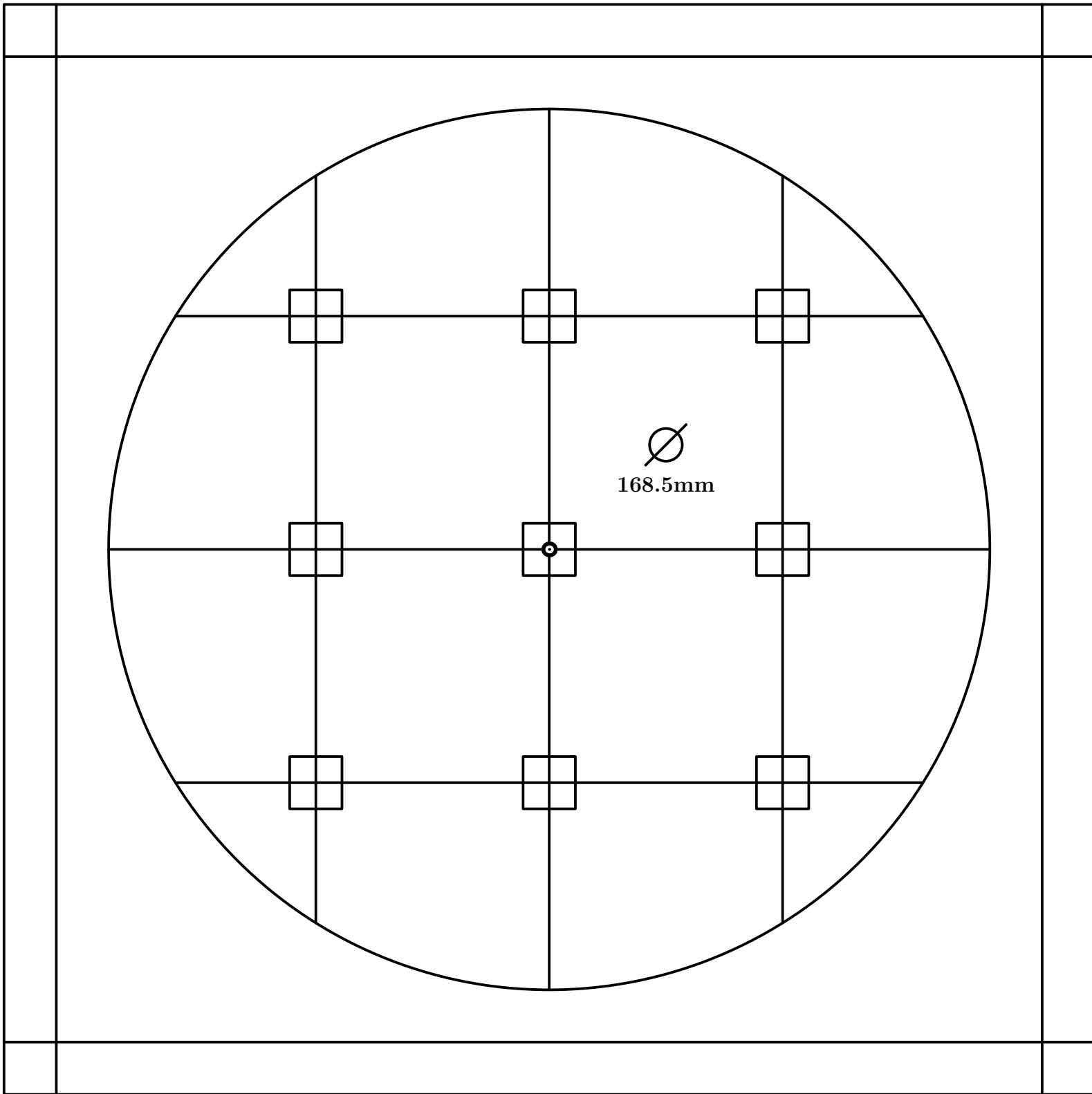

Fig. 275

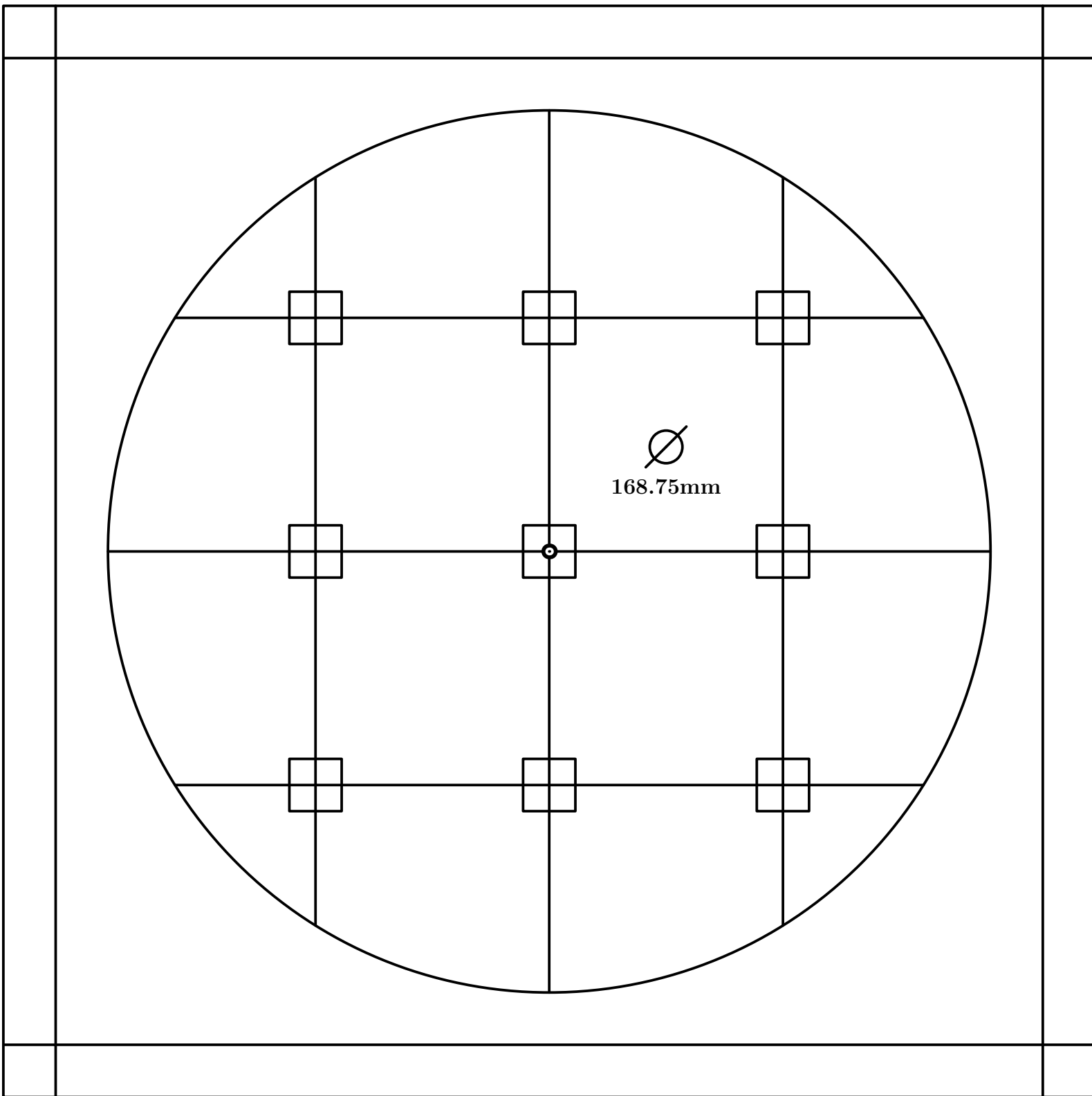

Fig. 276

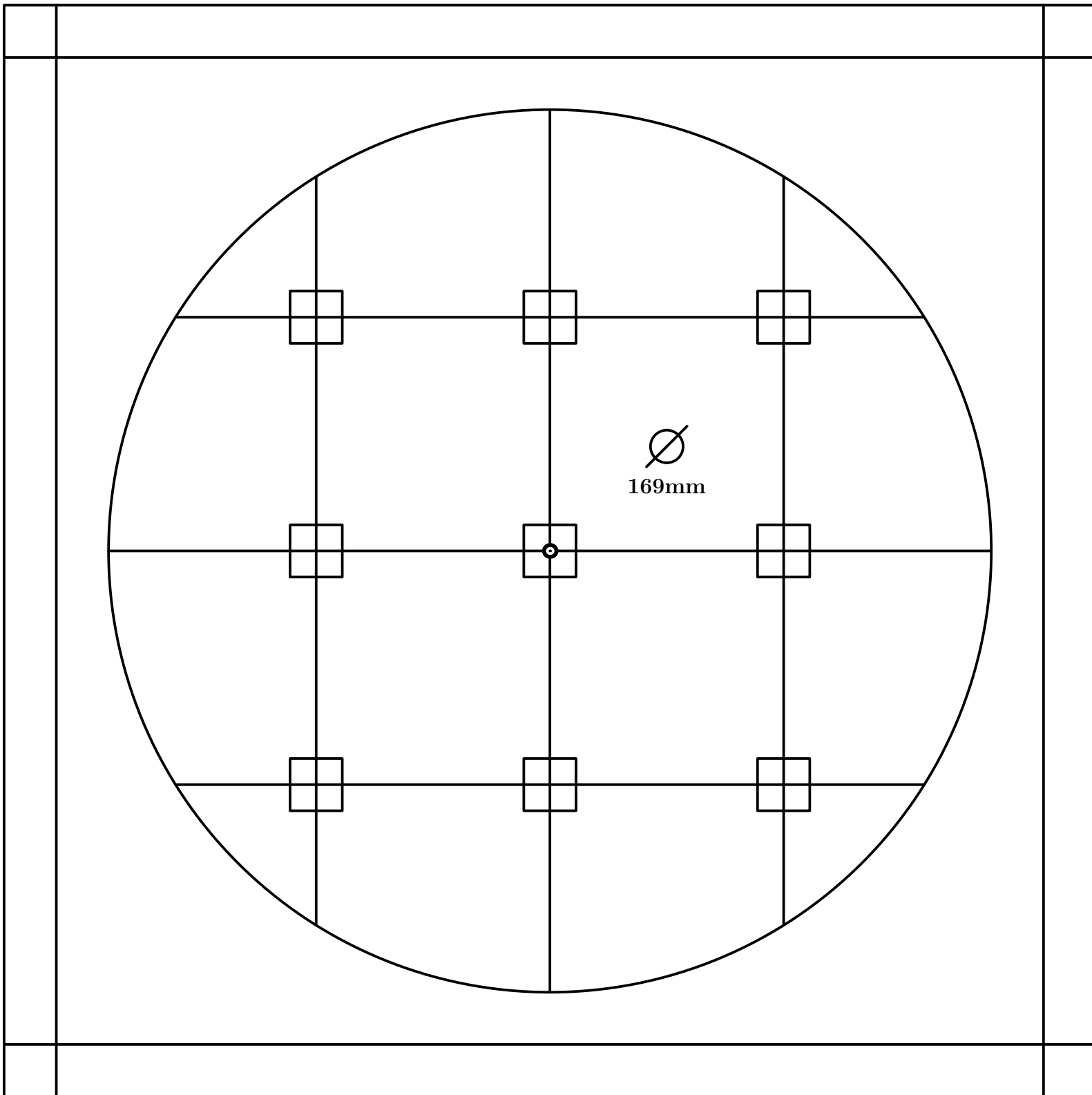

Fig. 277

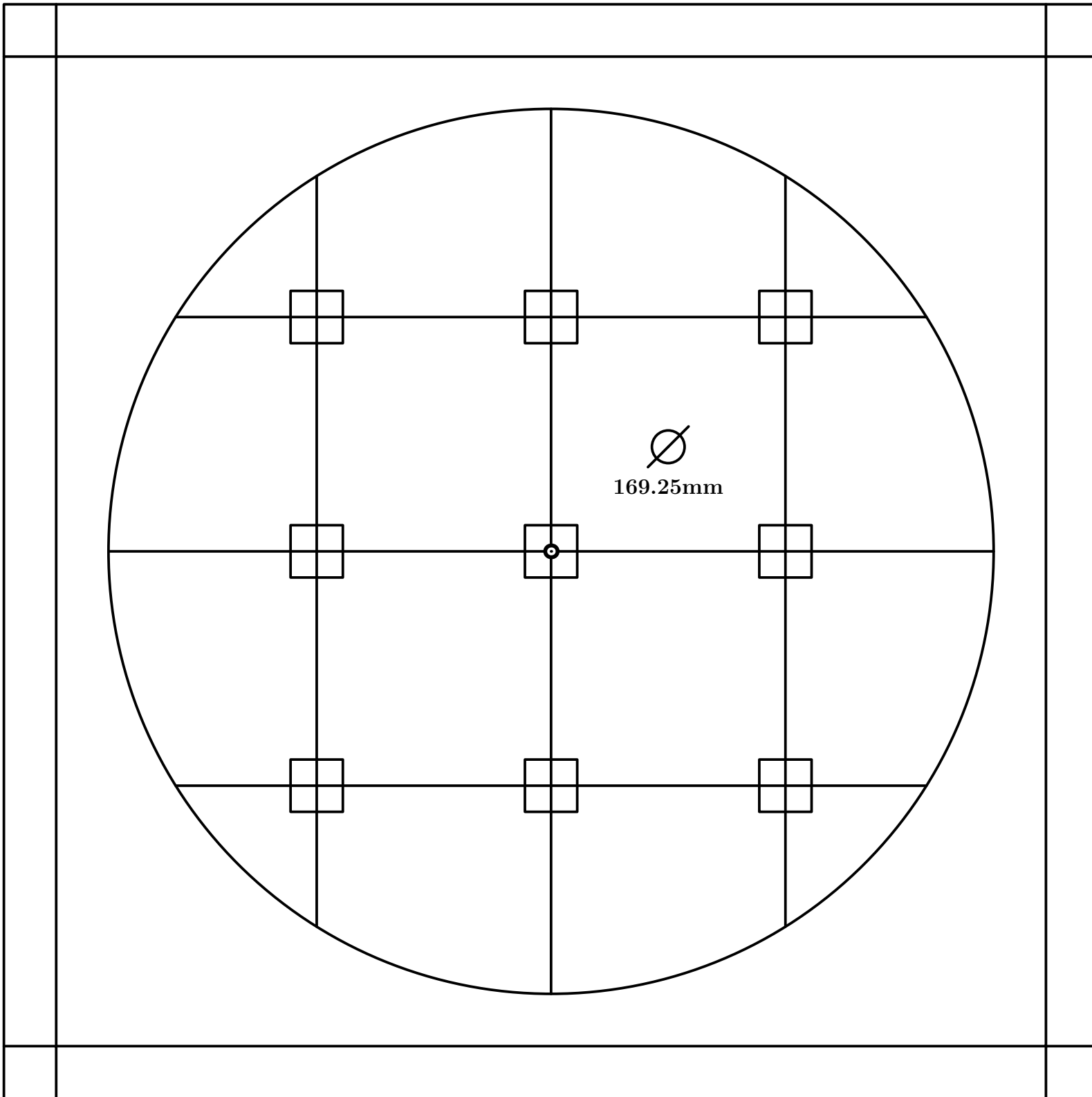

Fig. 278

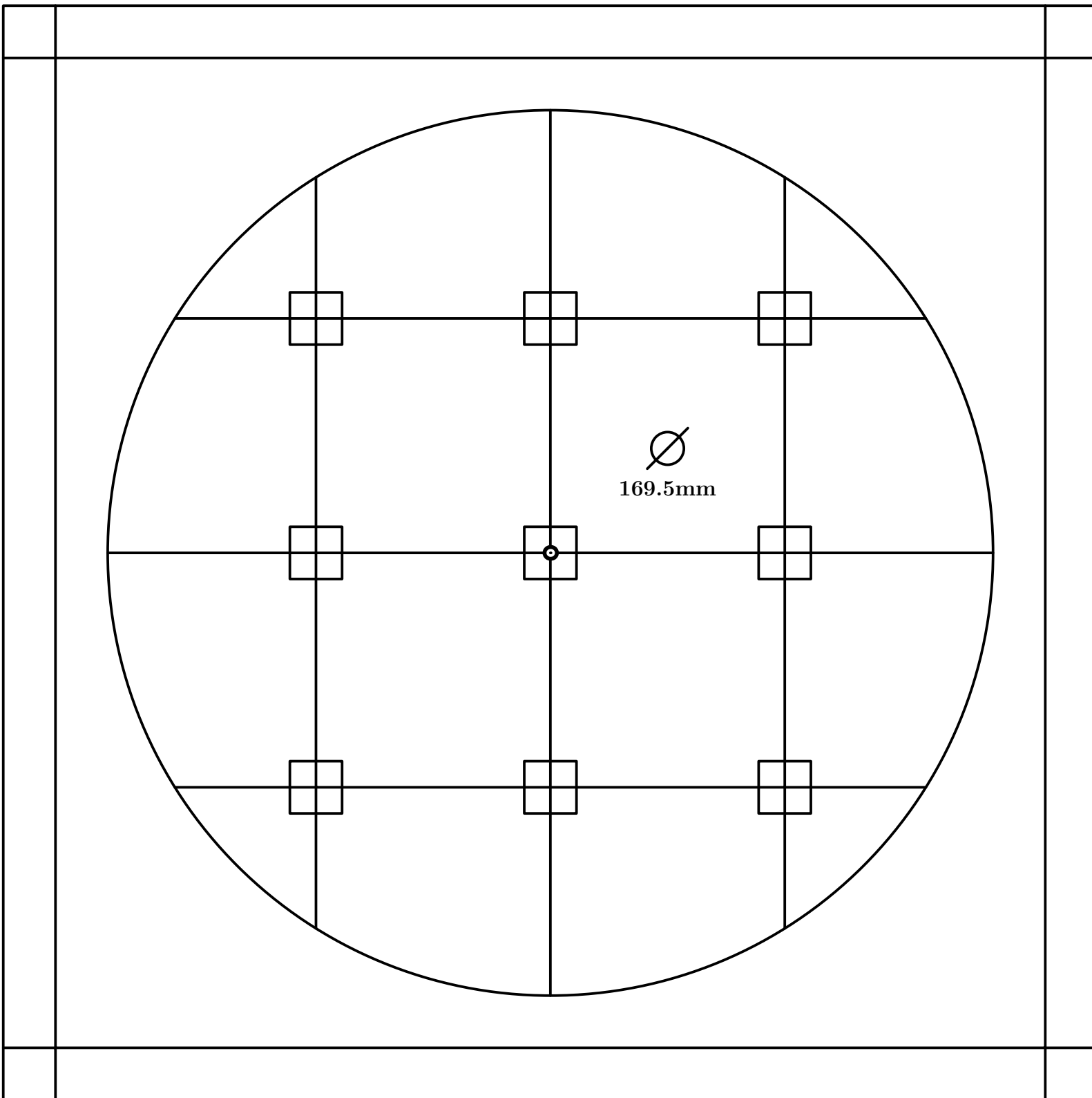

Fig. 279

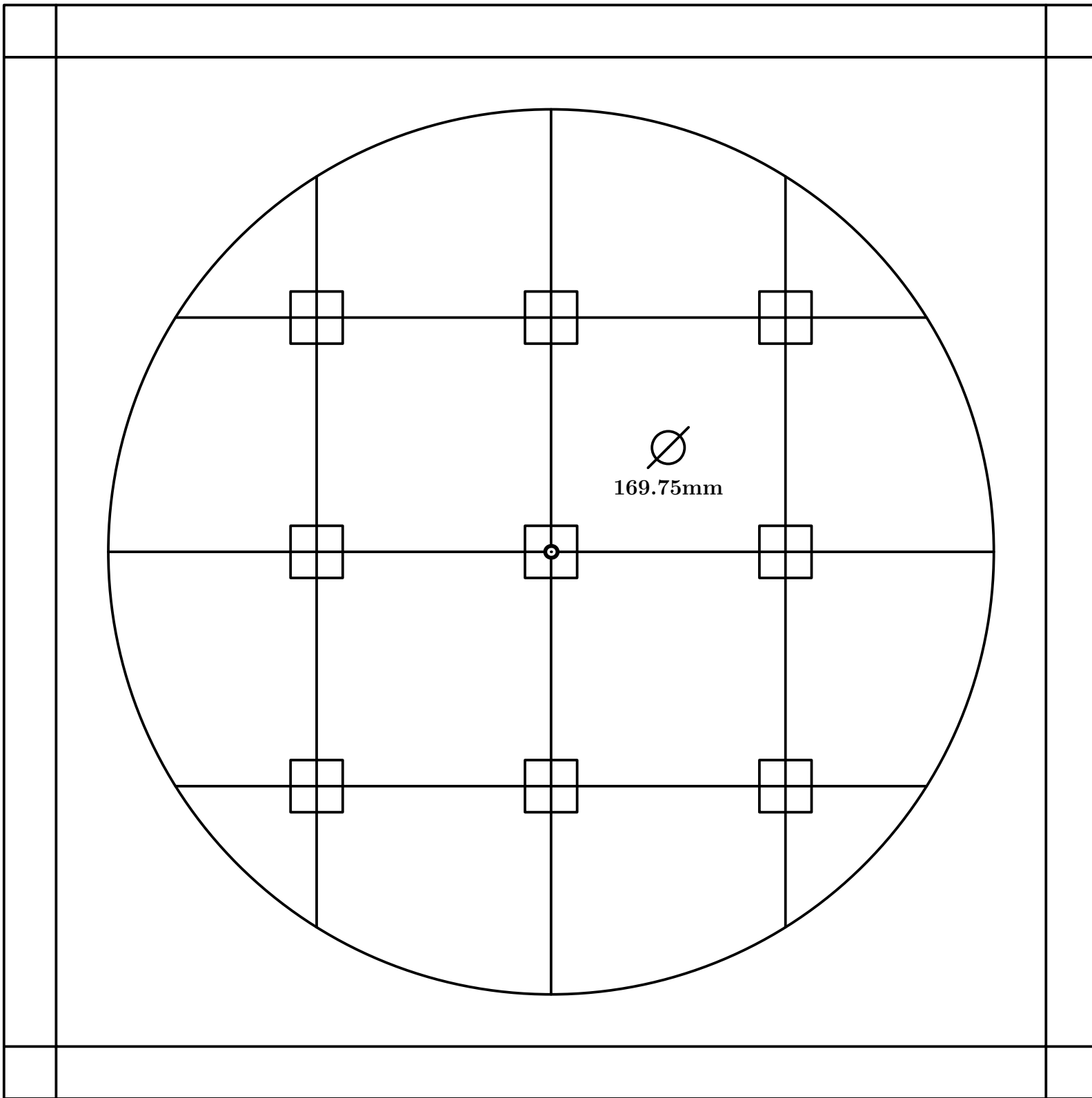

Fig. 280

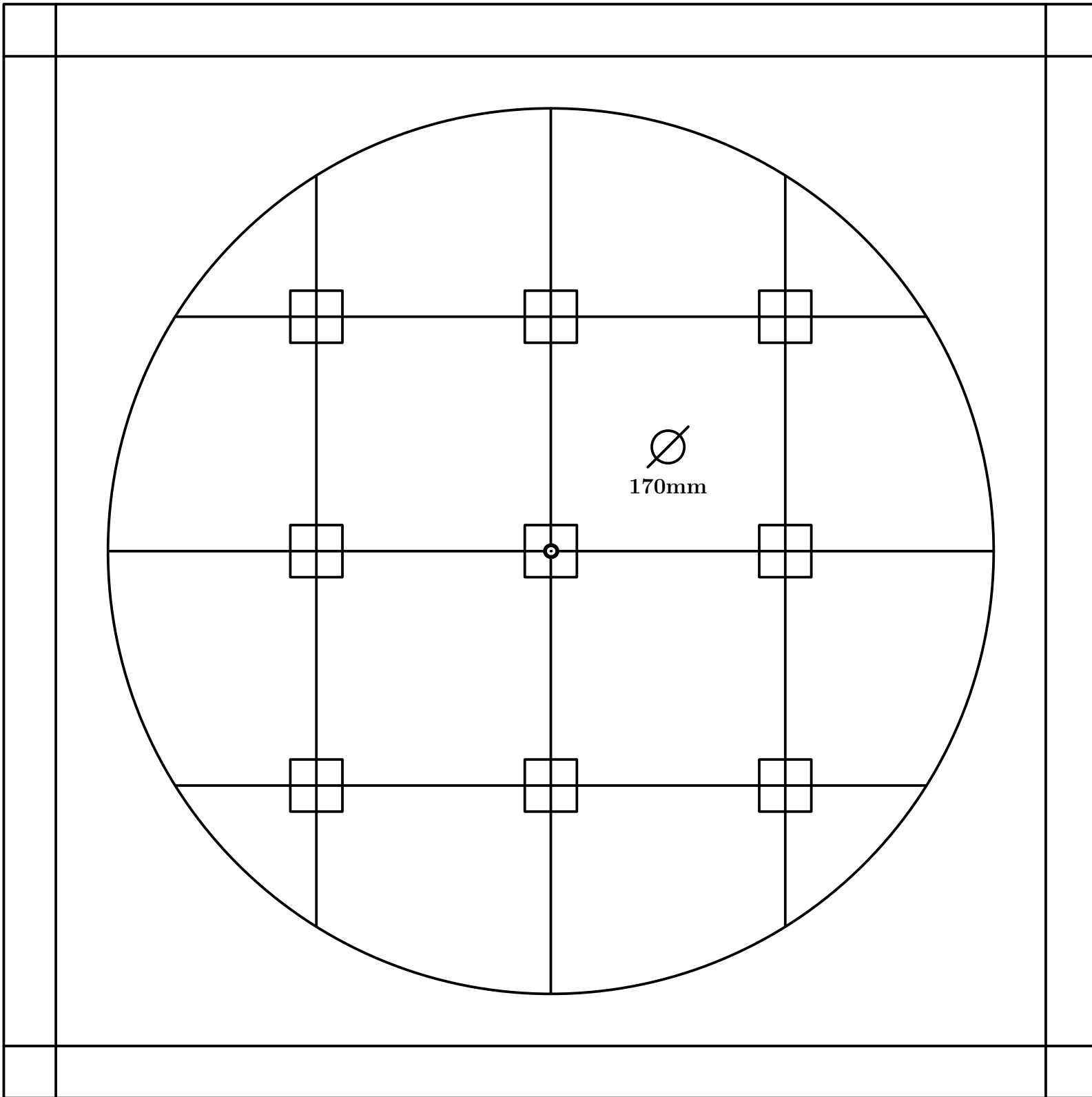

Fig. 281

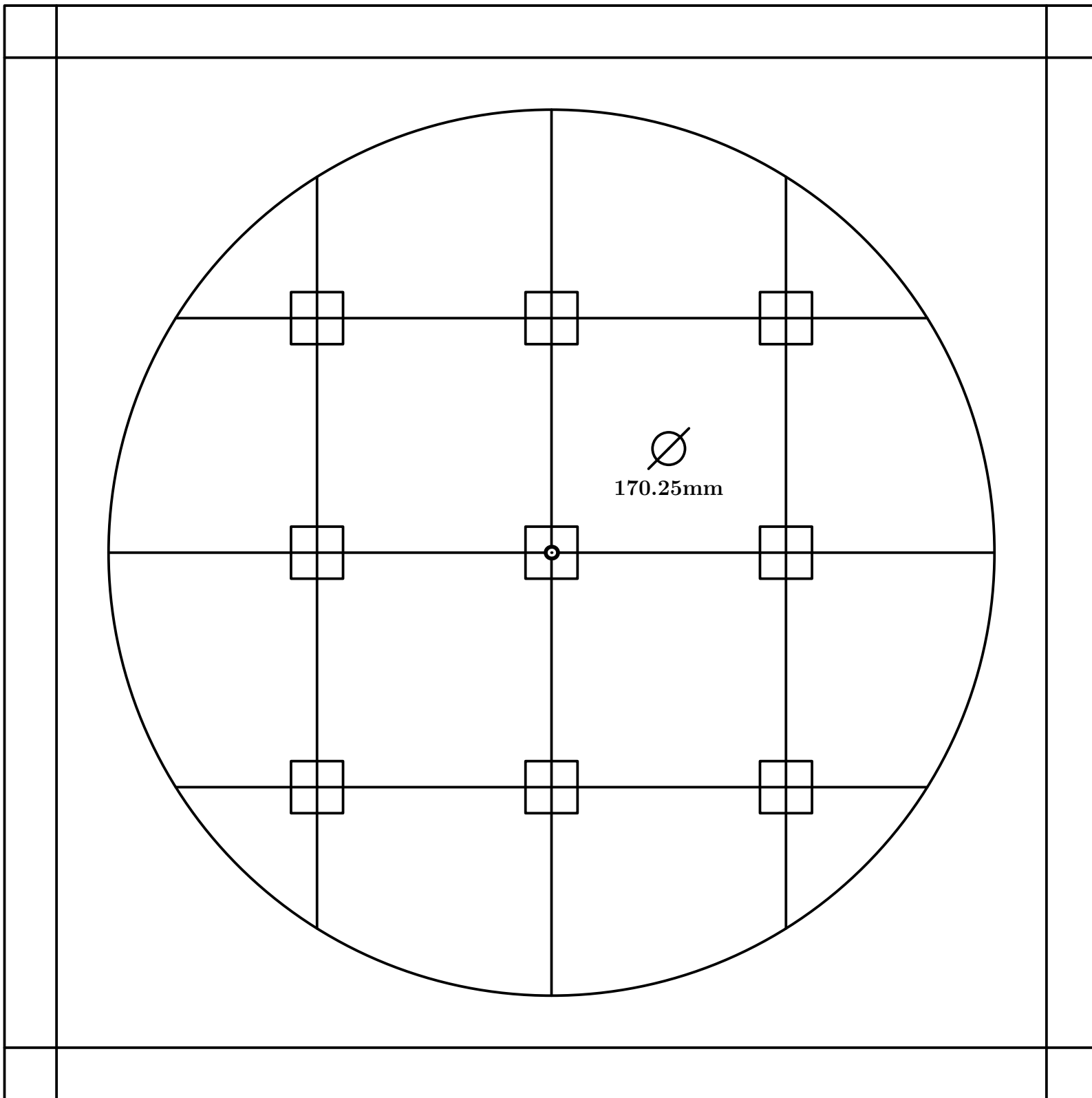

Fig. 282

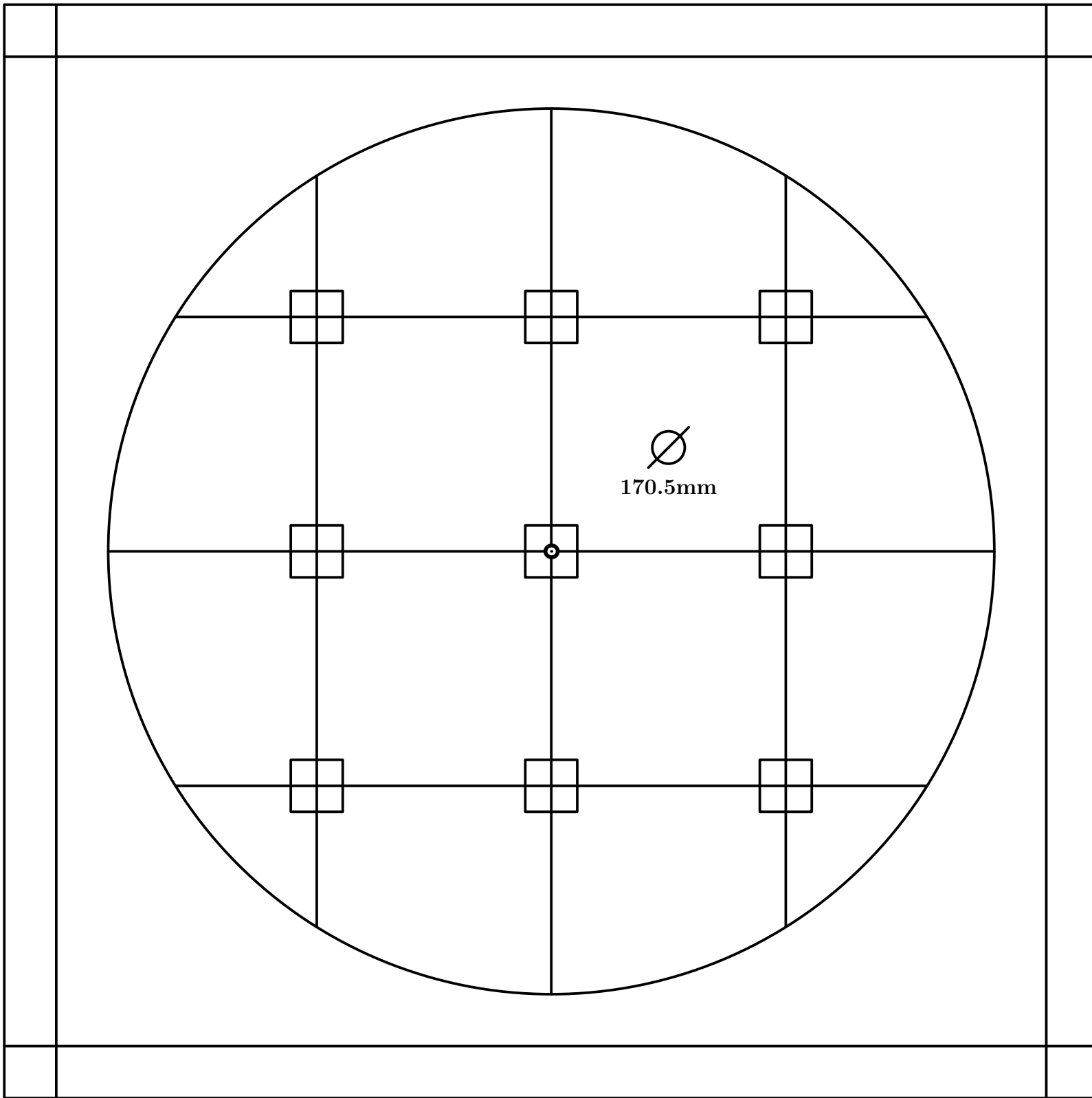

Fig. 283

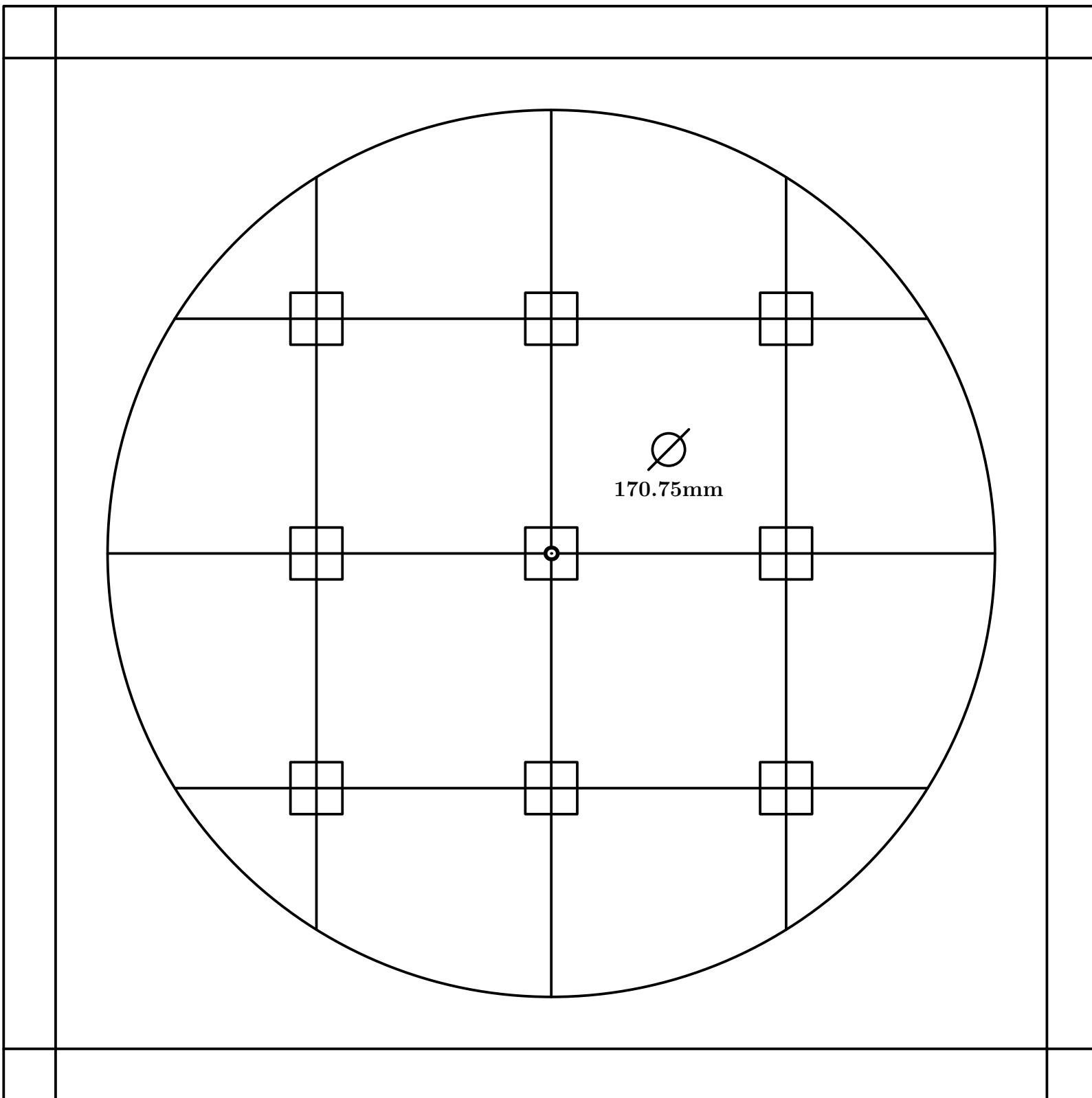

Fig. 284

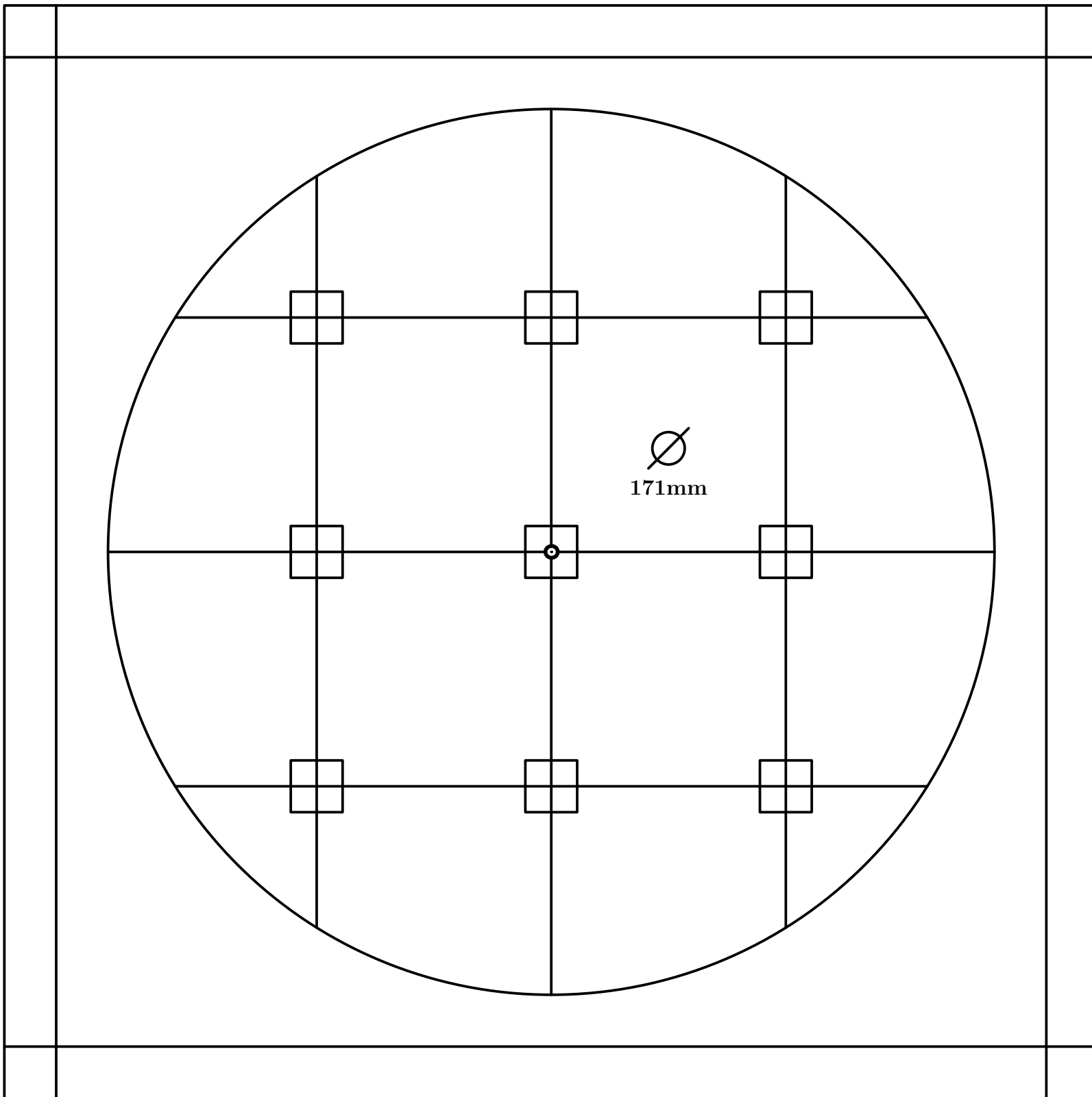

Fig. 285

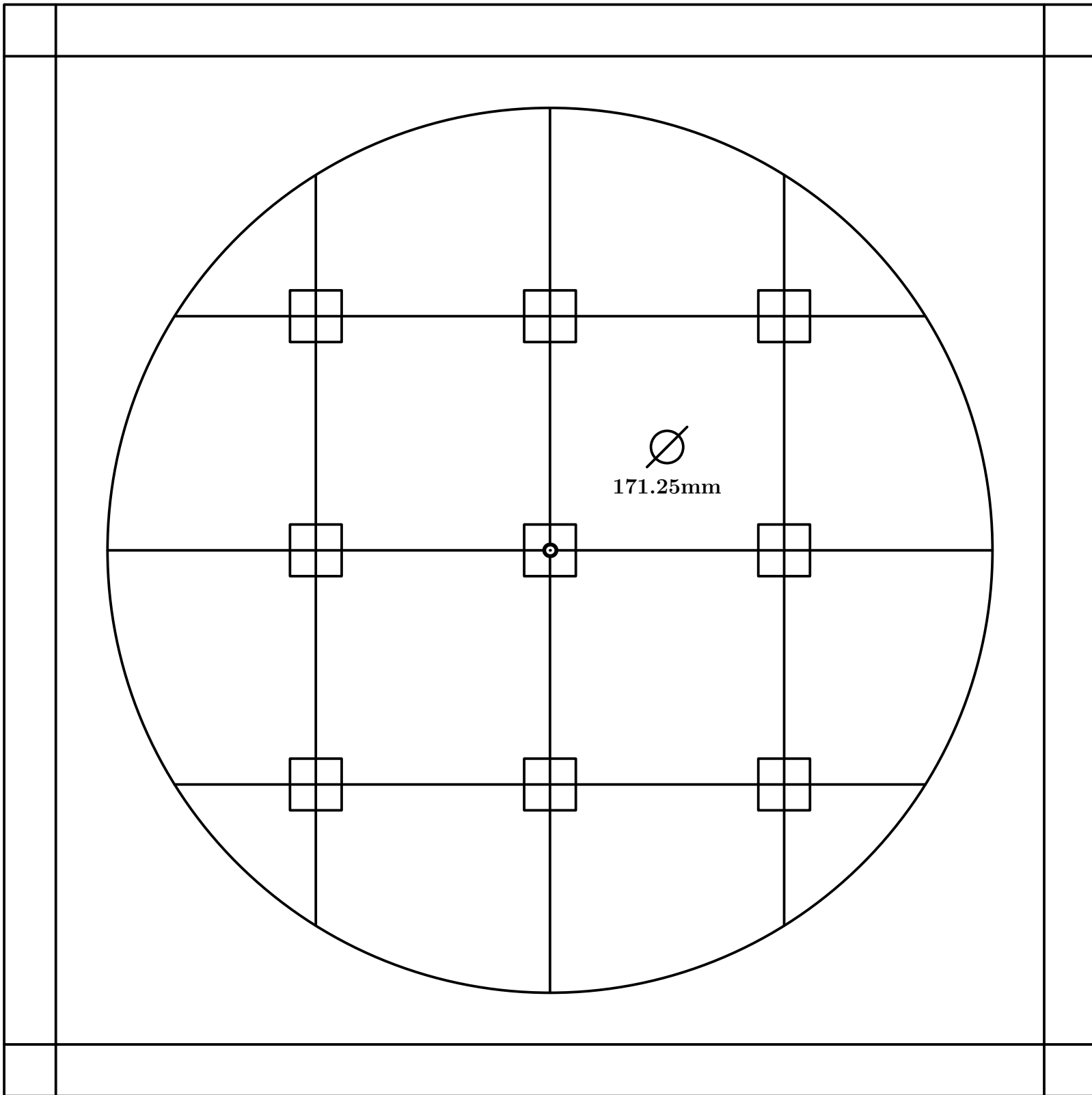

Fig. 286

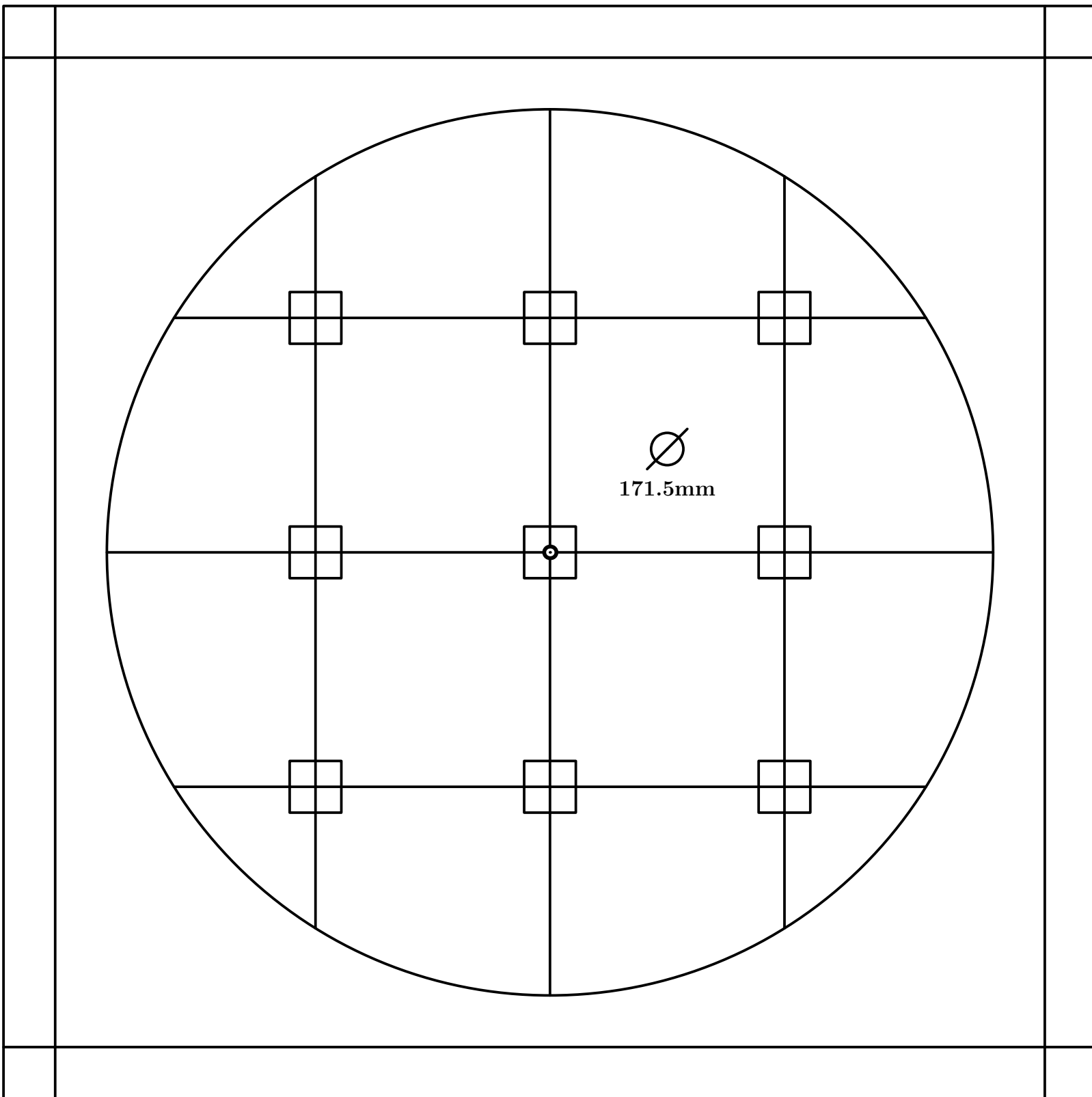

Fig. 287

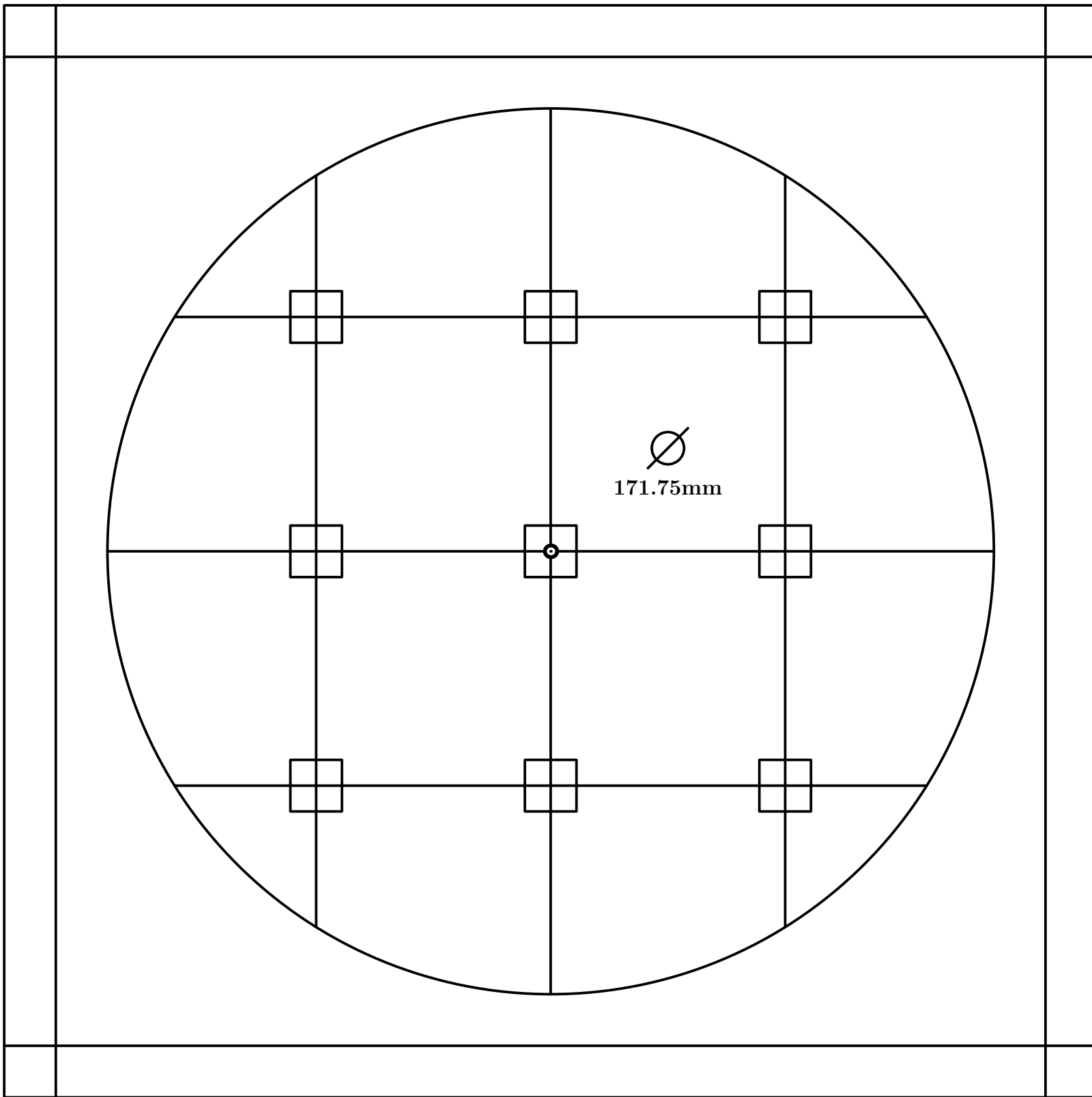

Fig. 288

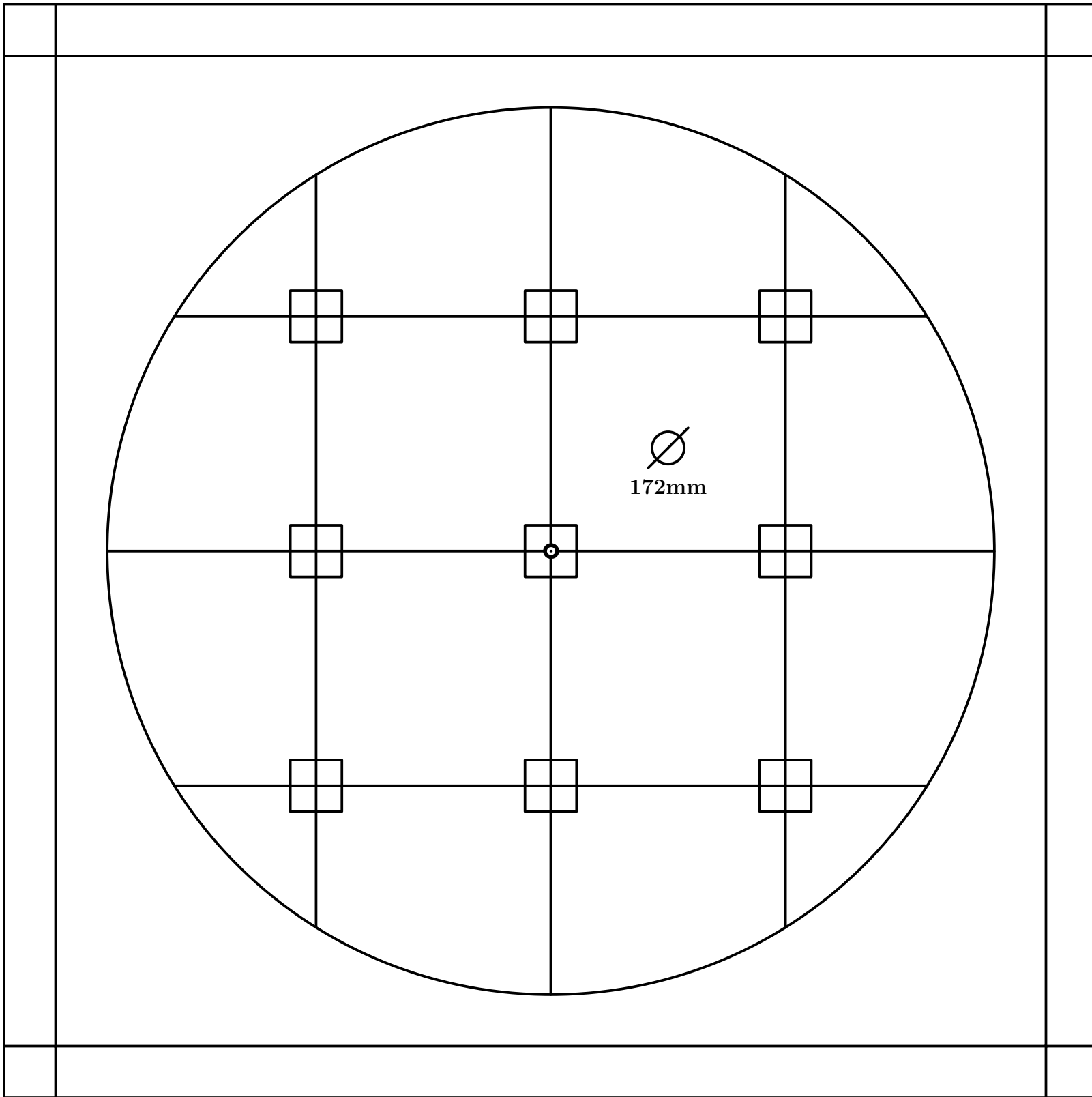

Fig. 289

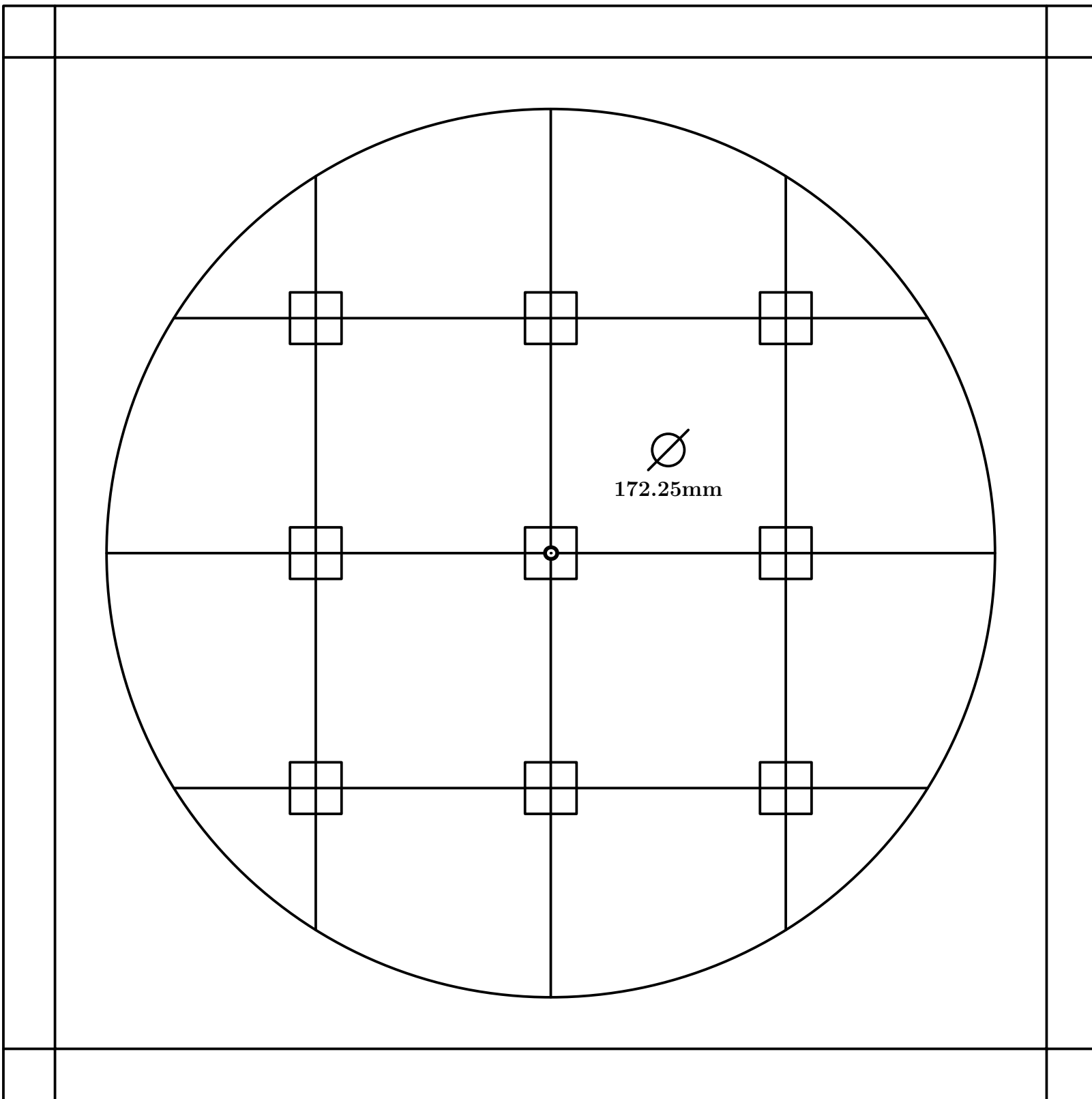

Fig. 290

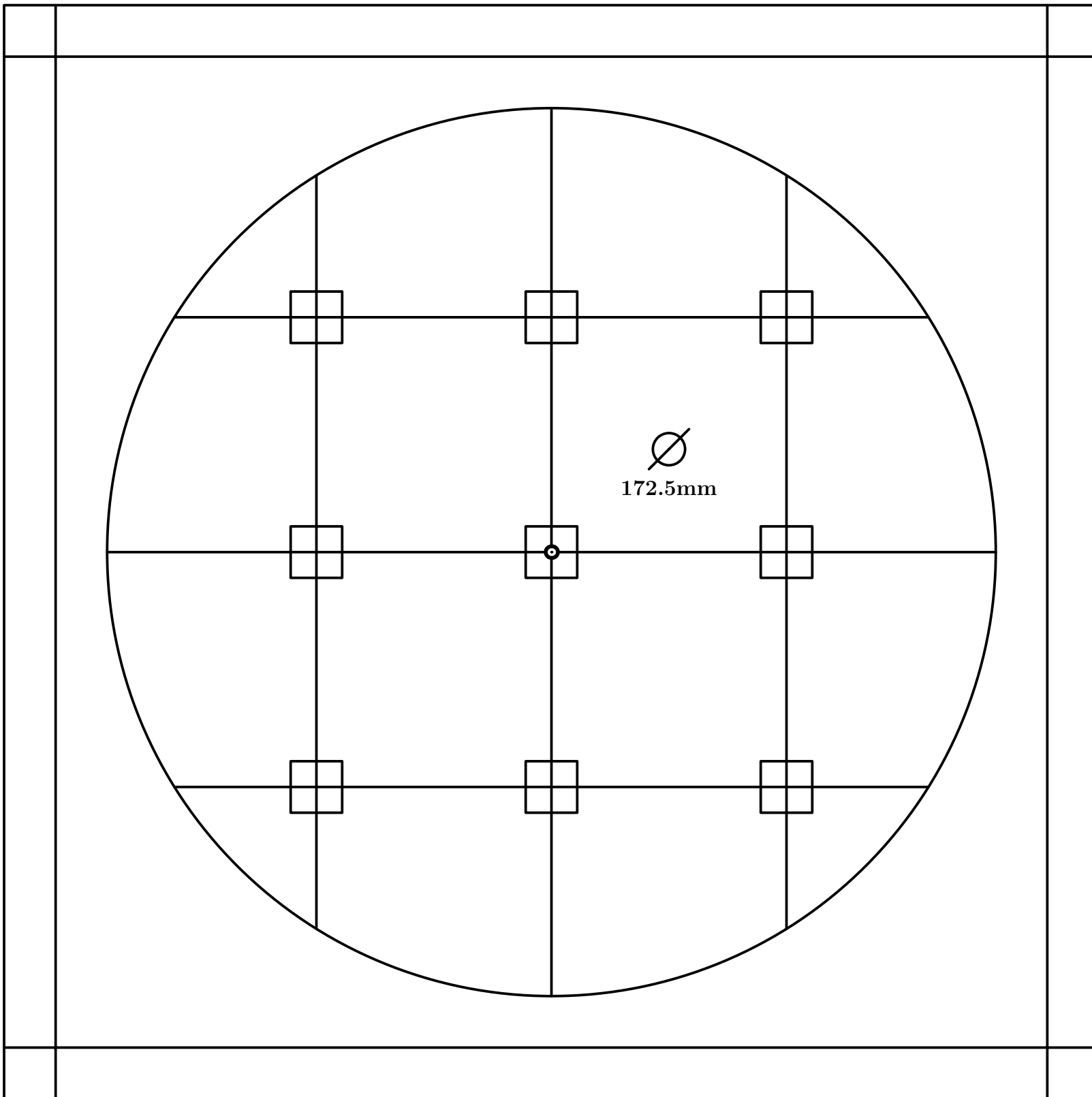

Fig. 291

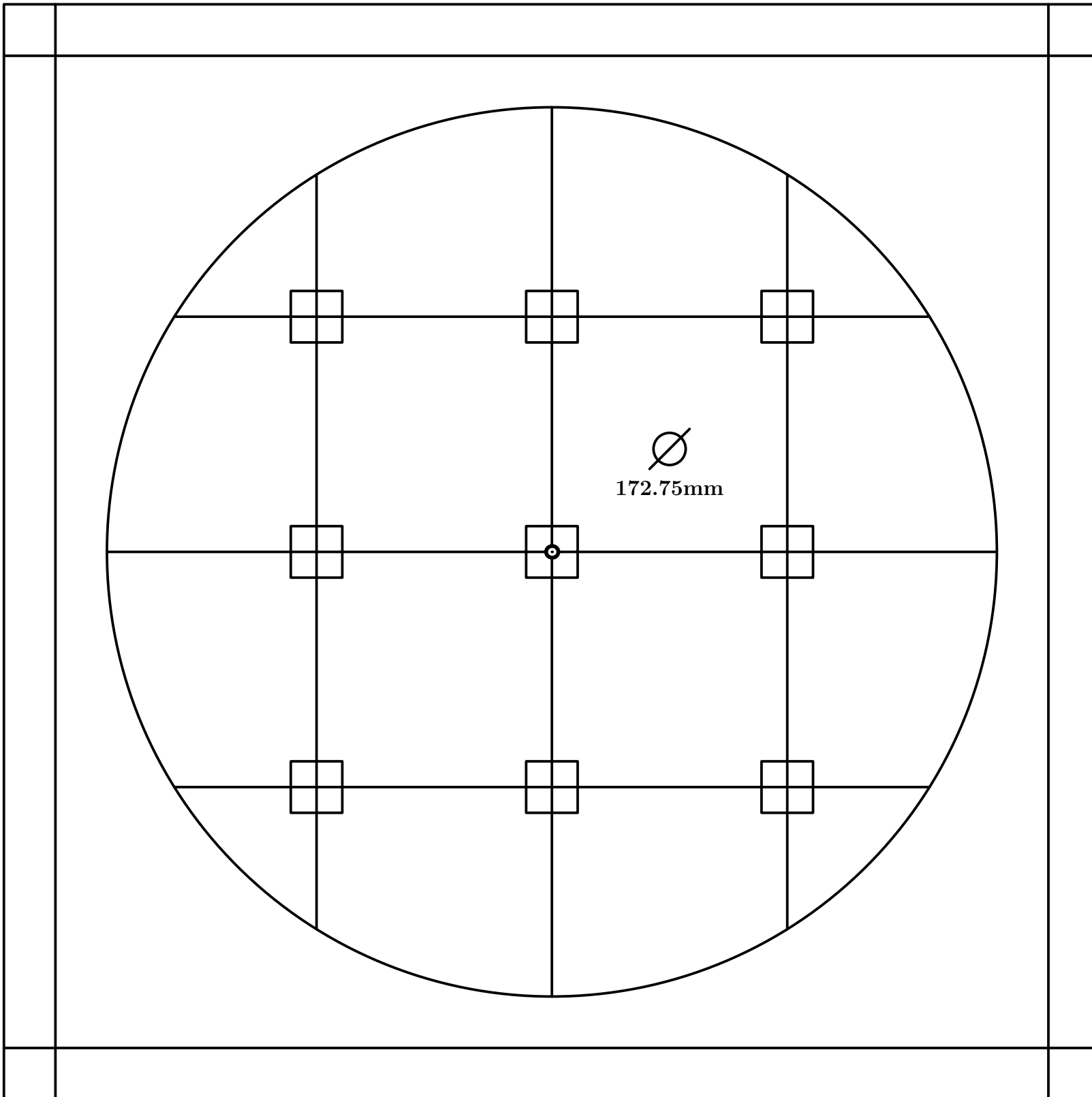

Fig. 292

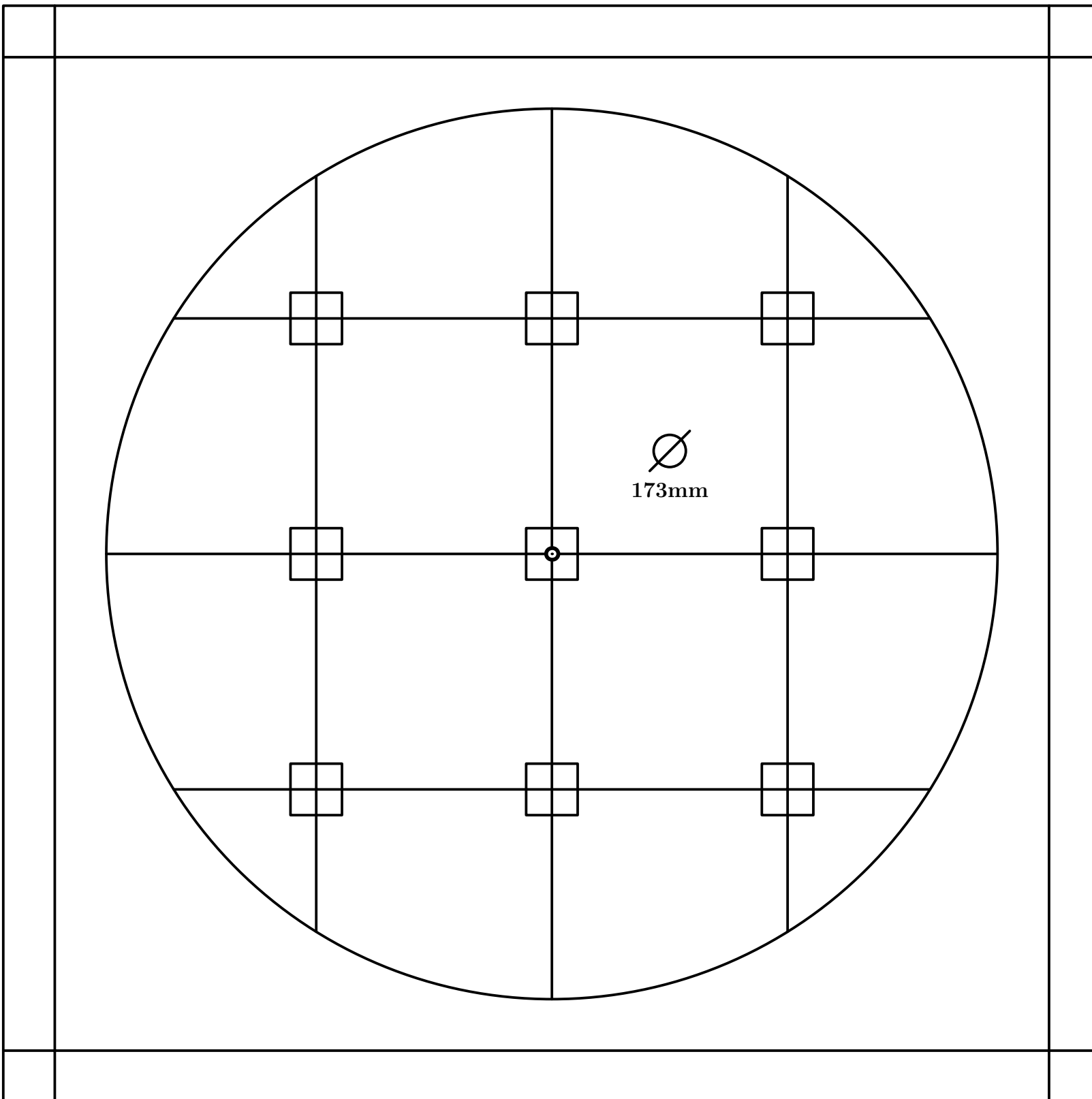

Fig. 293

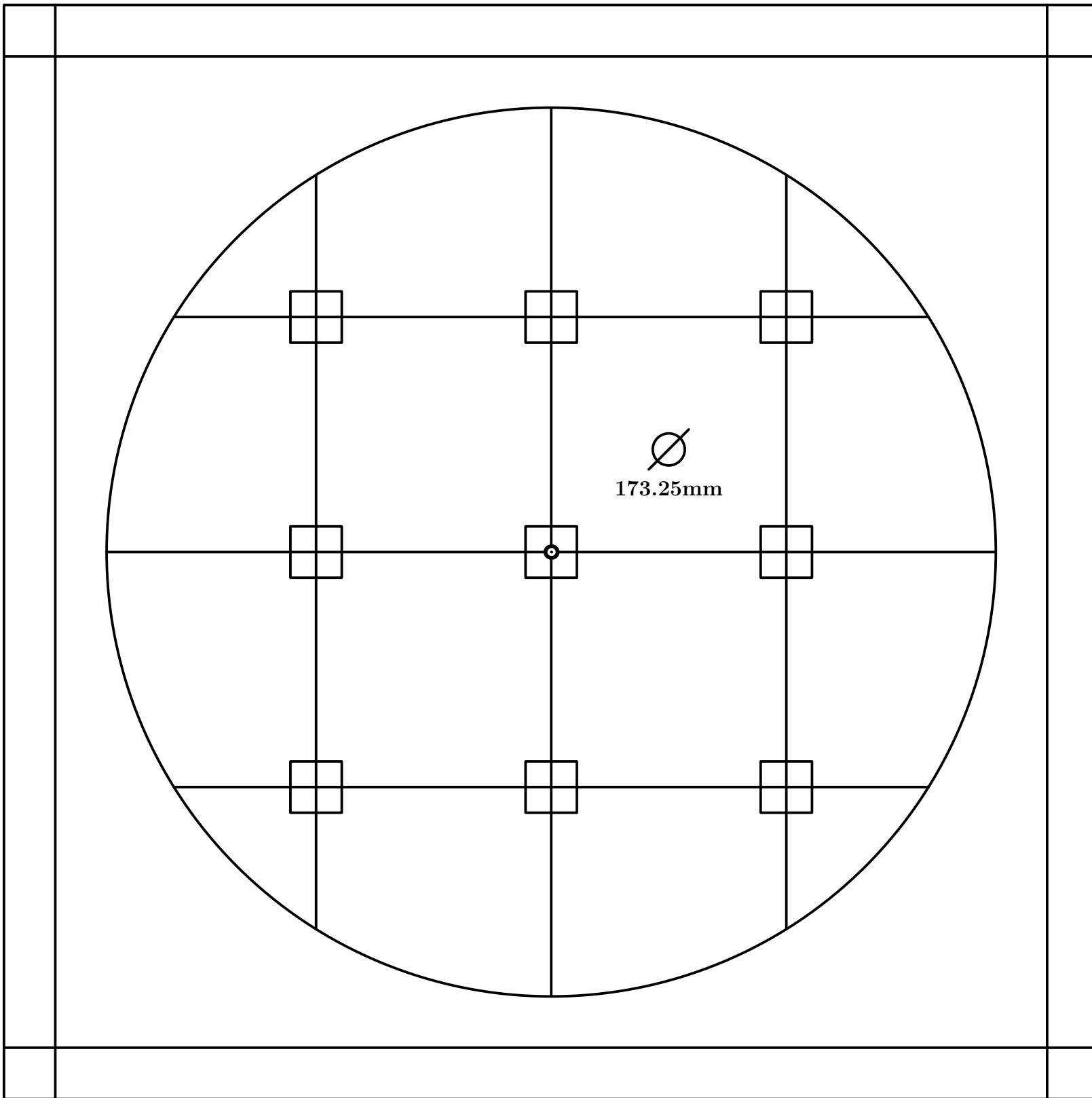

Fig. 294

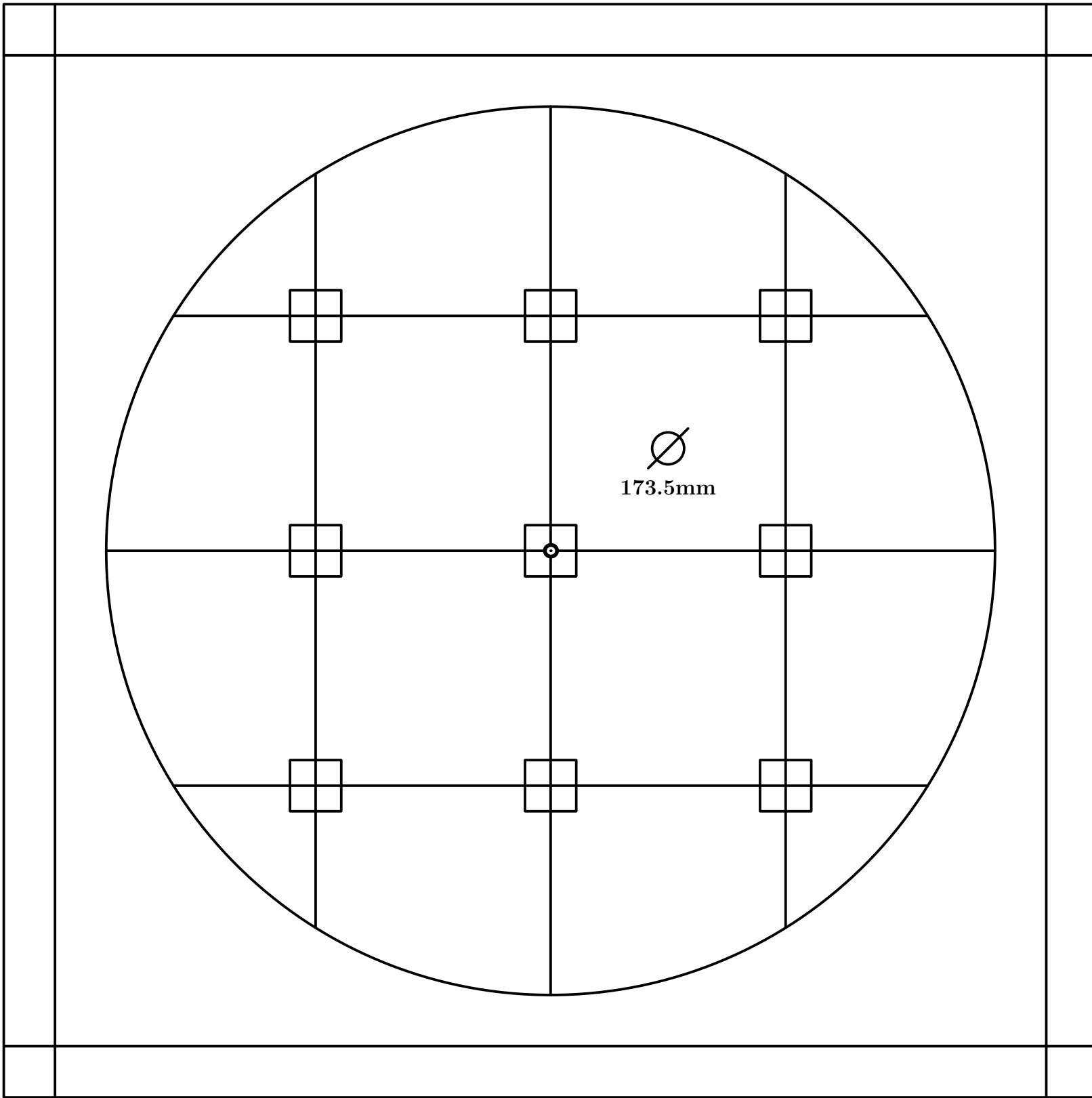

Fig. 295

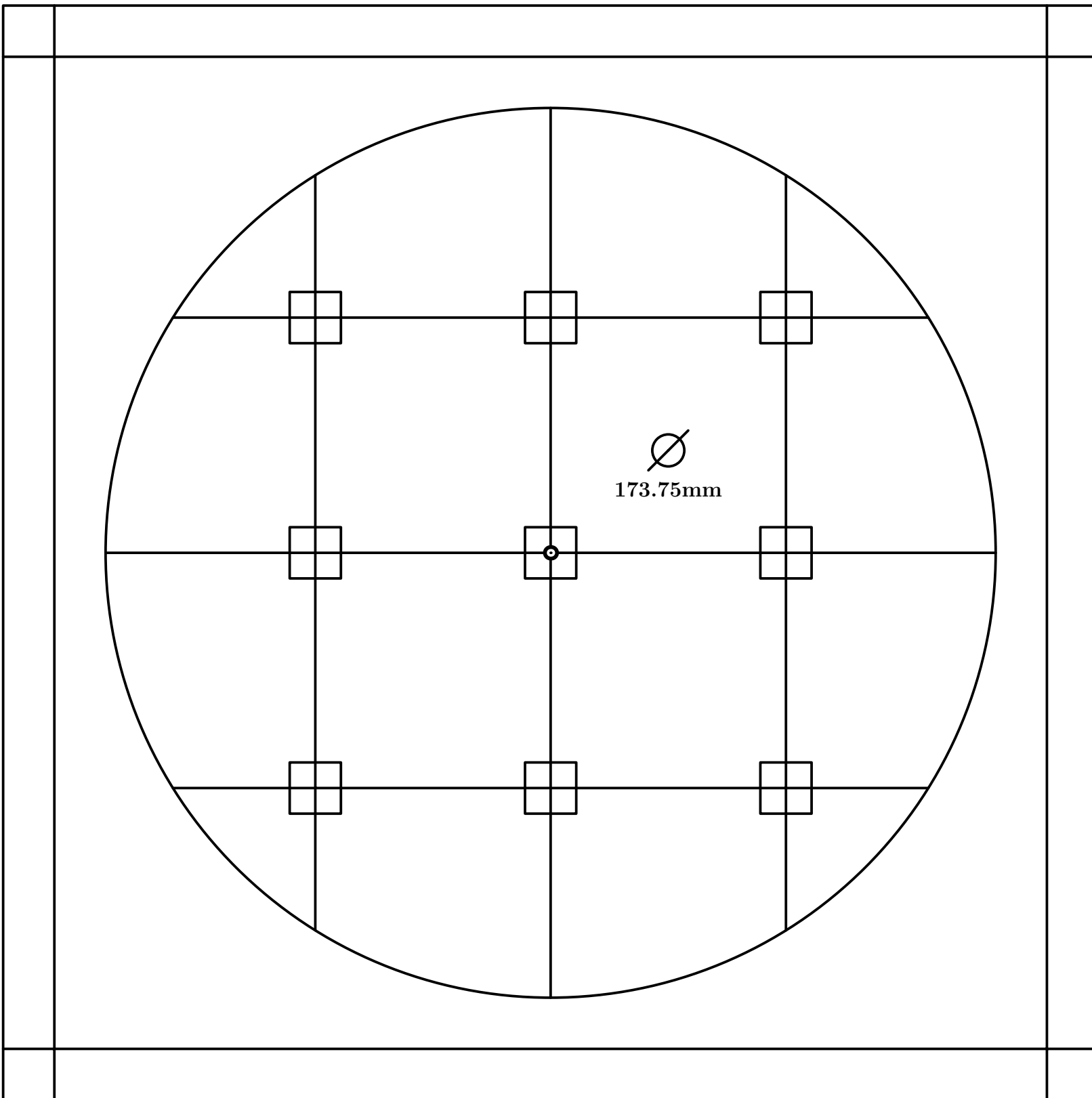

Fig. 296

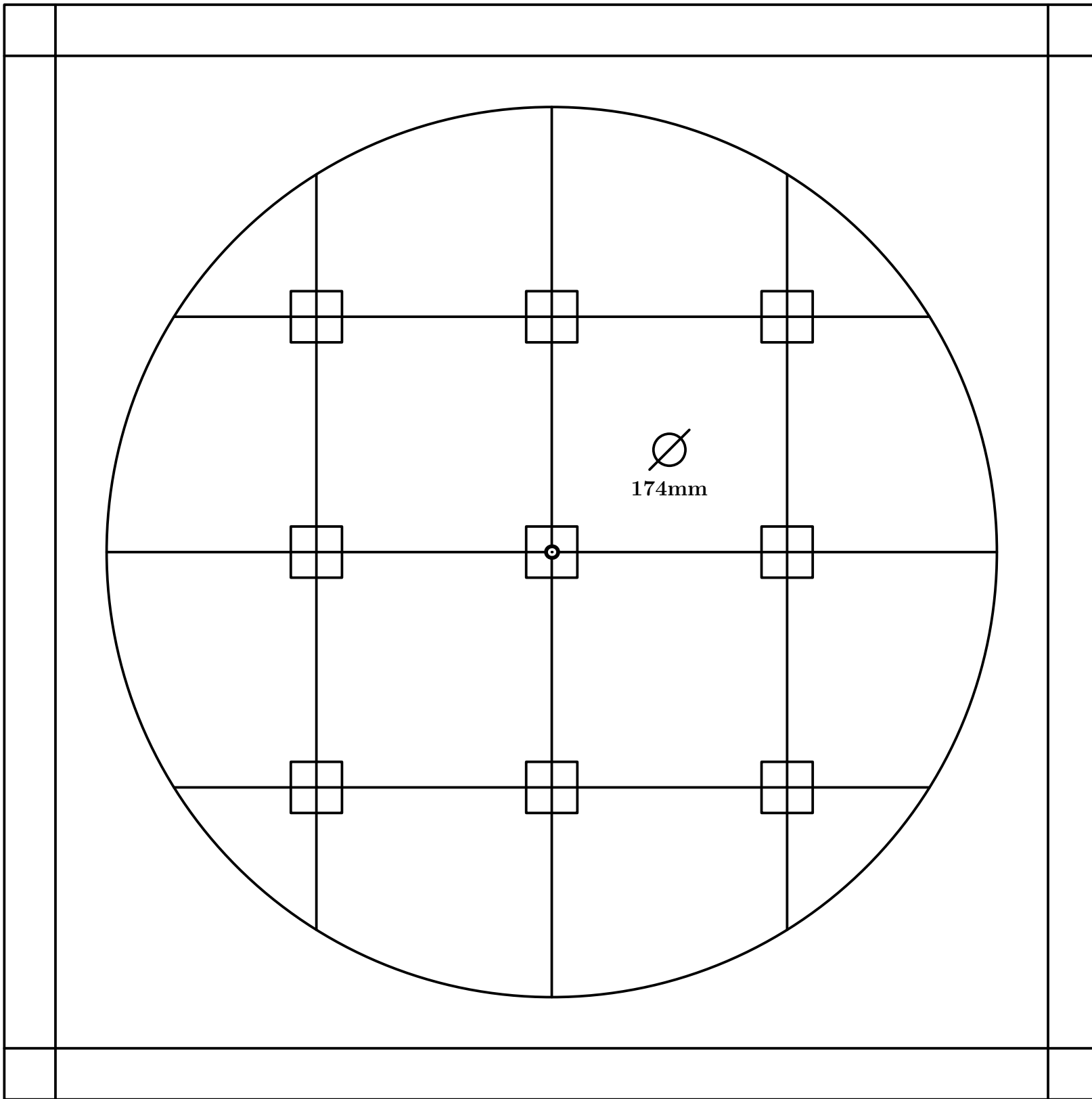

Fig. 297

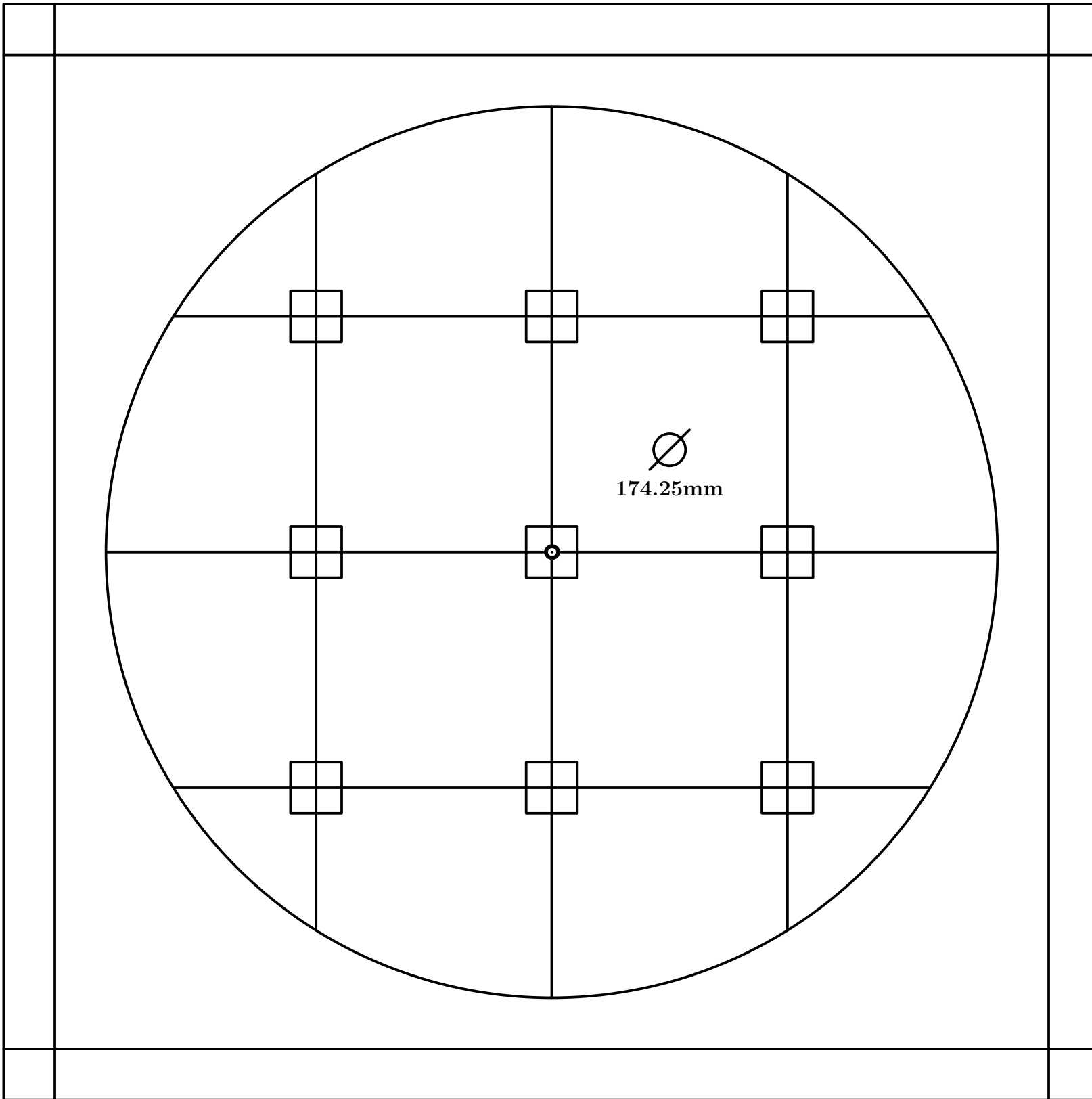

Fig. 298

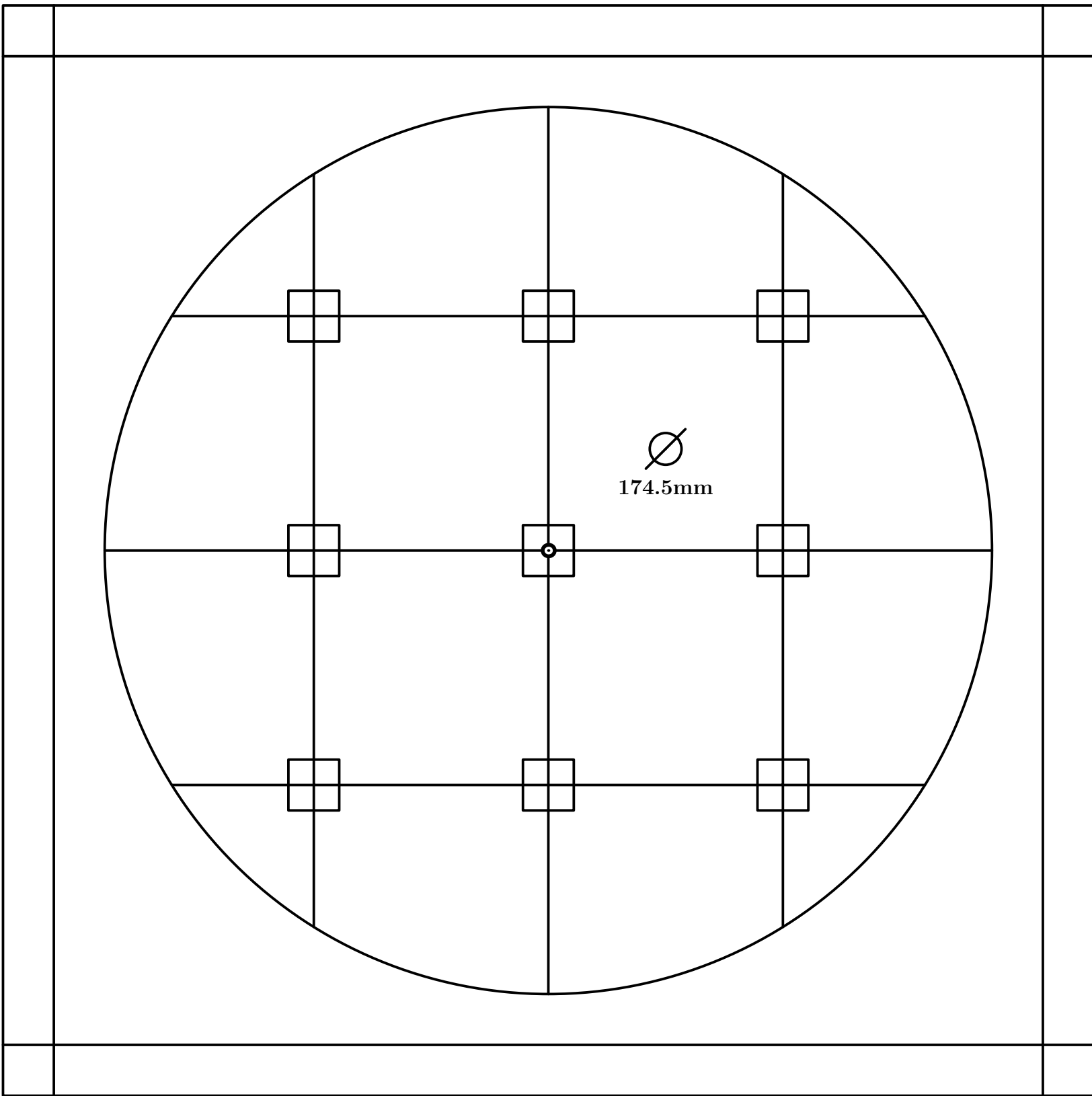

Fig. 299

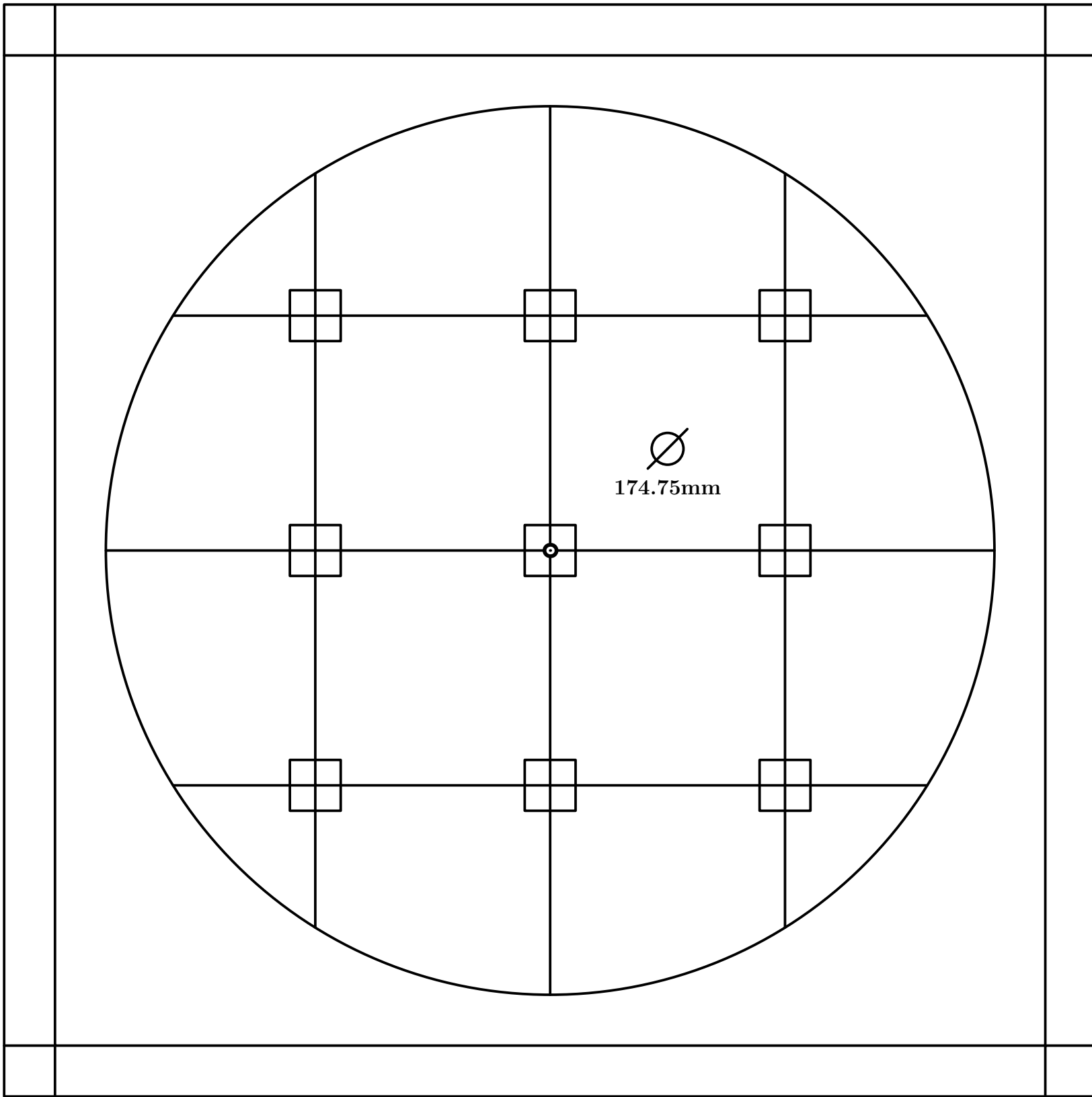

Fig. 300

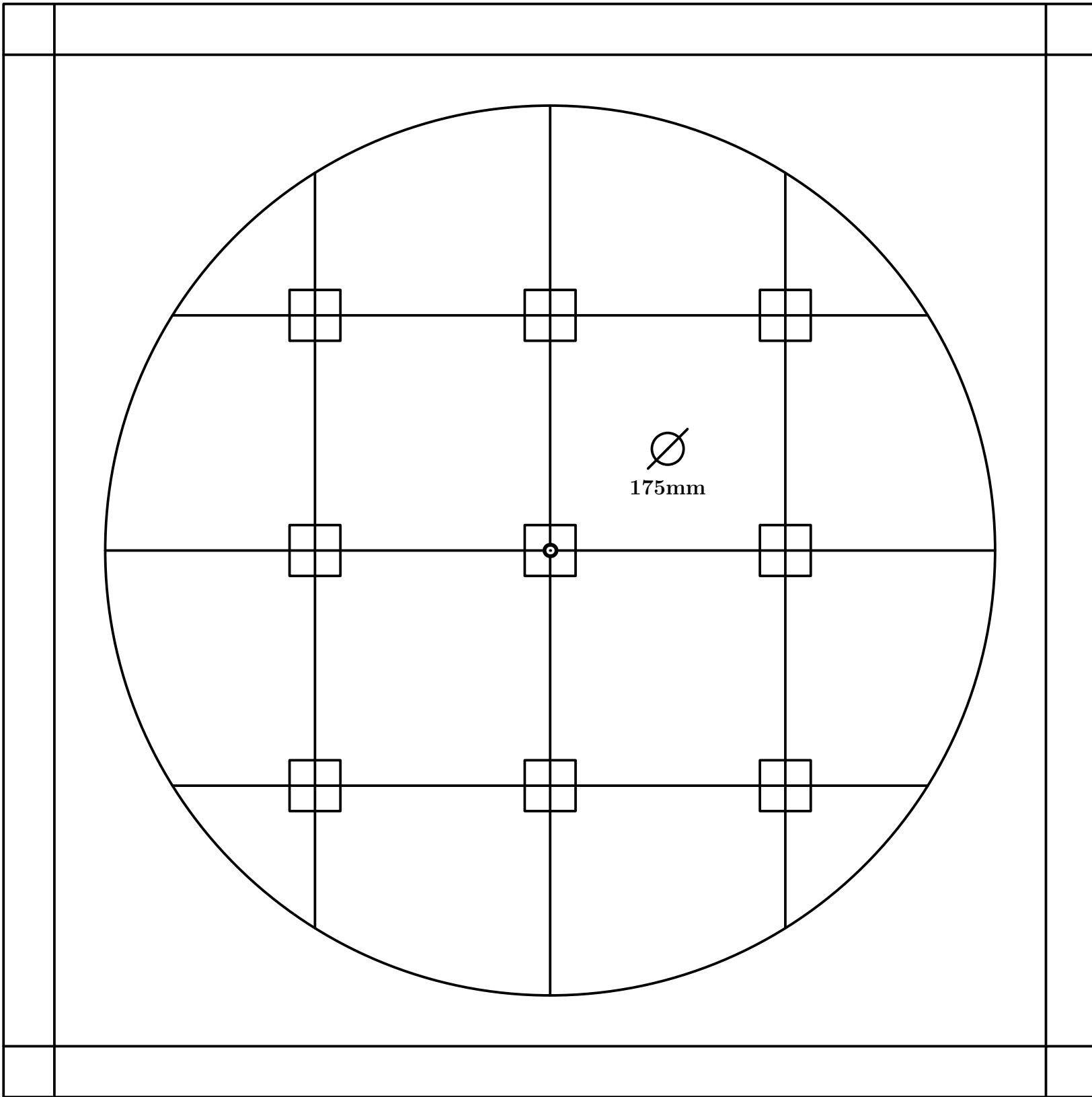

Fig. 301

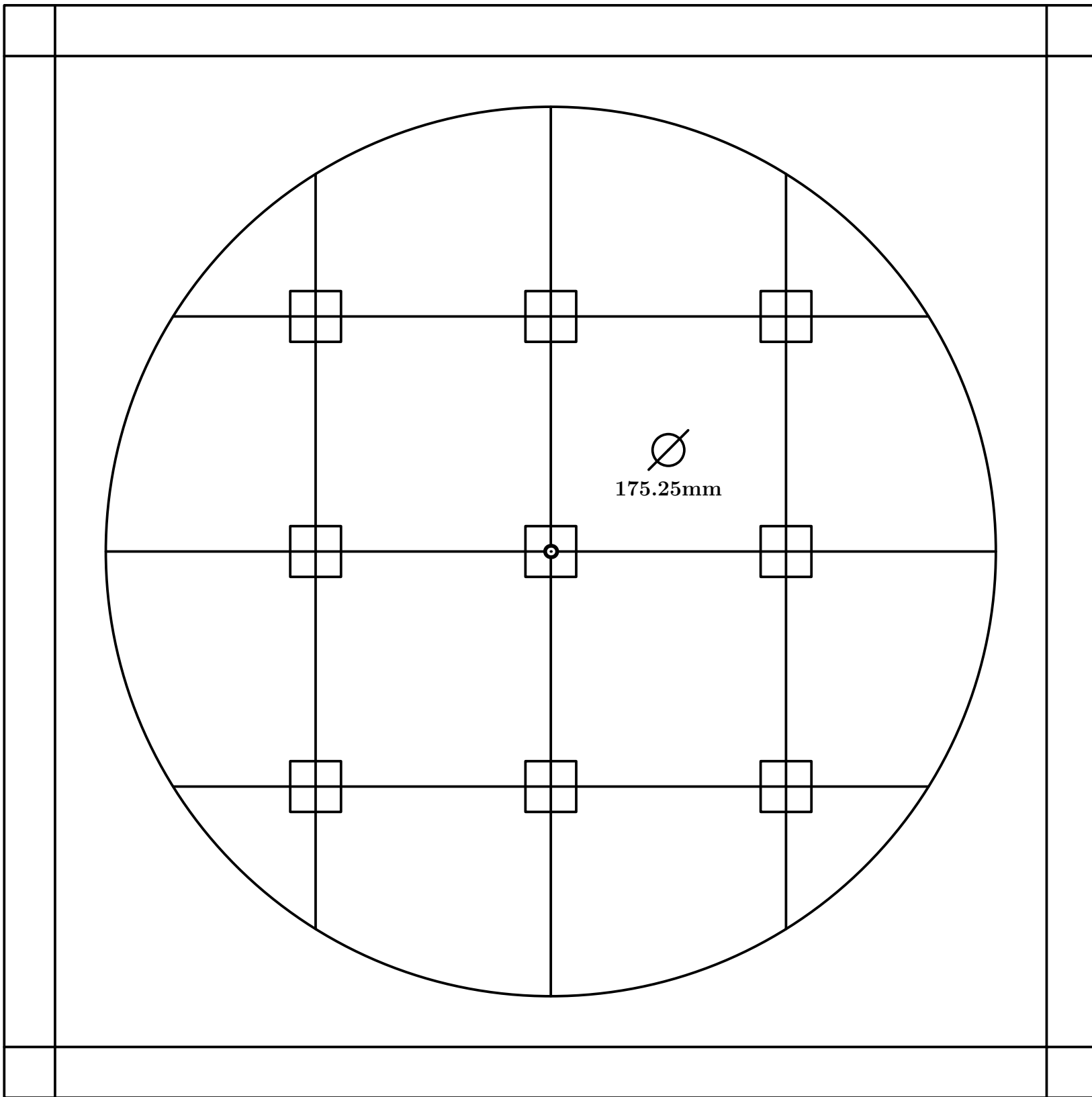

Fig. 302

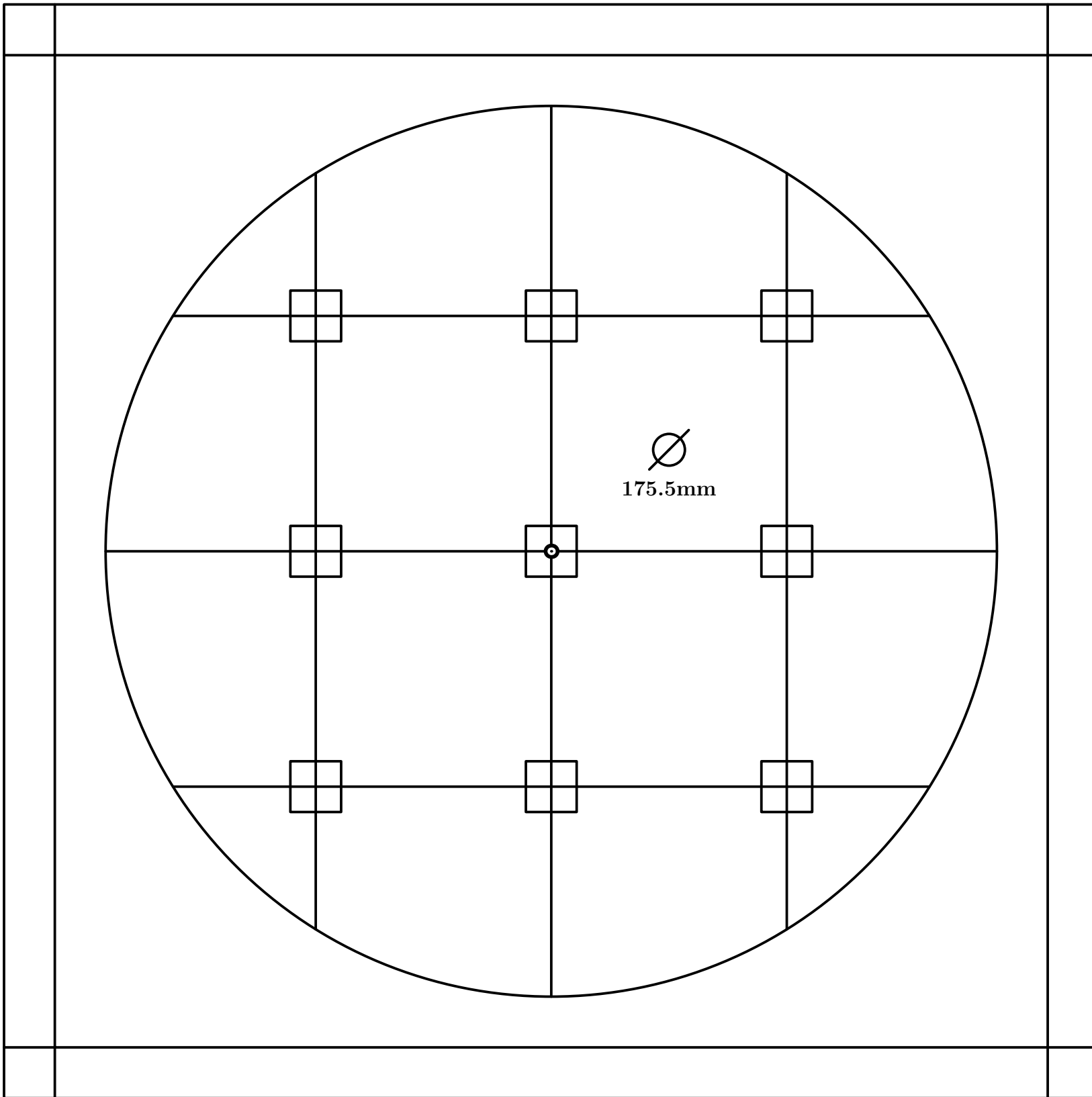

Fig. 303

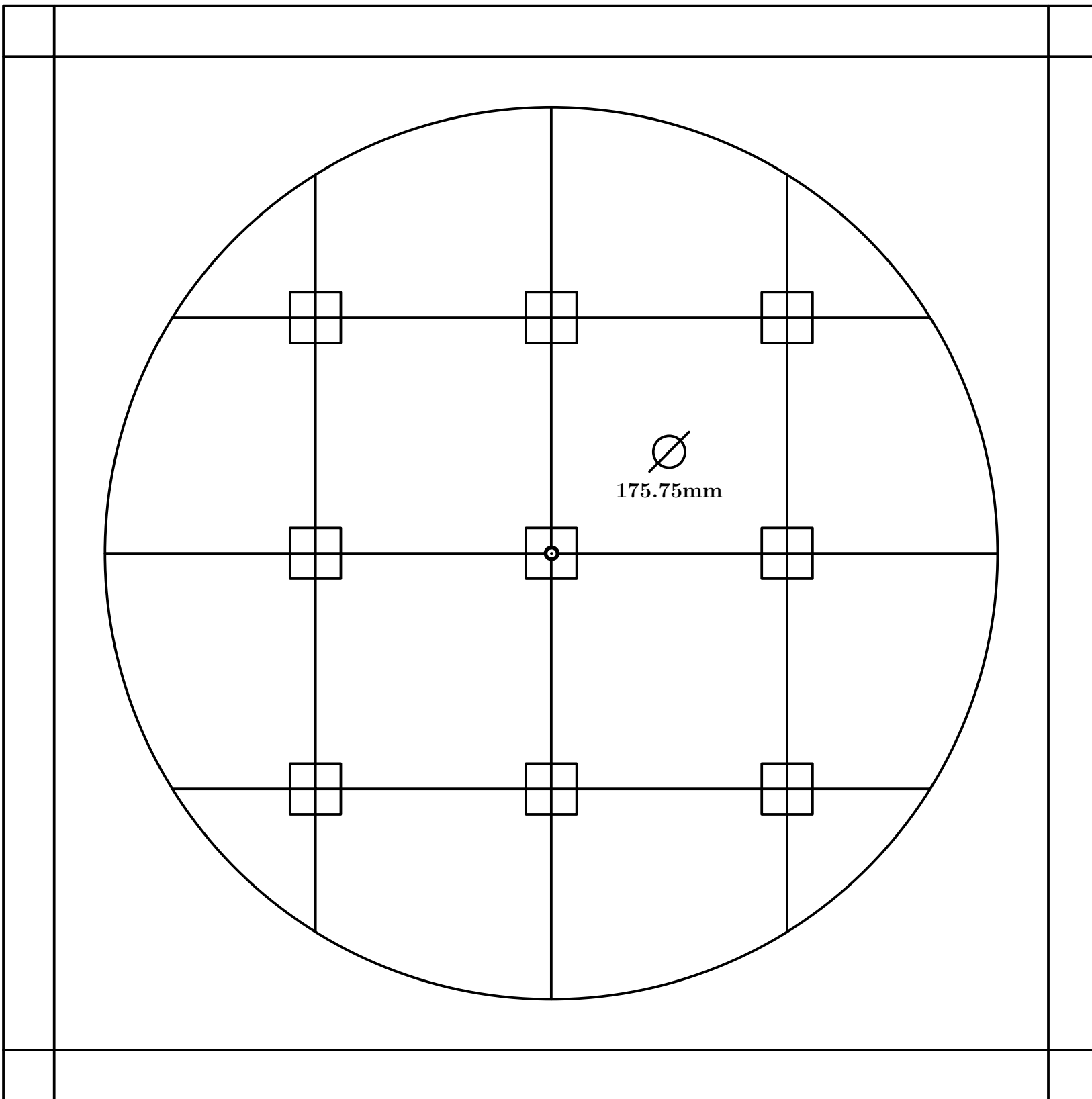

Fig. 304

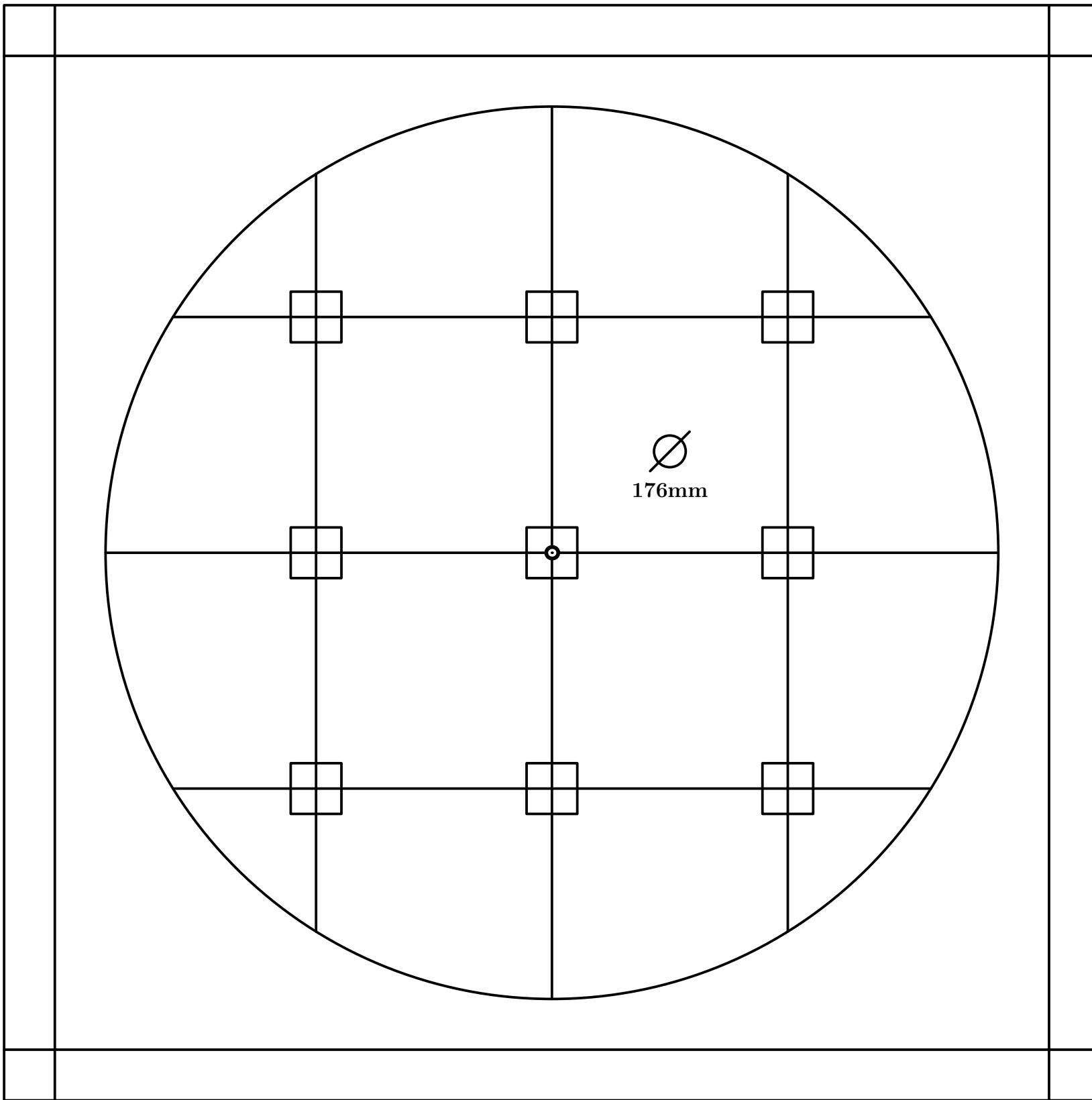

Fig. 305

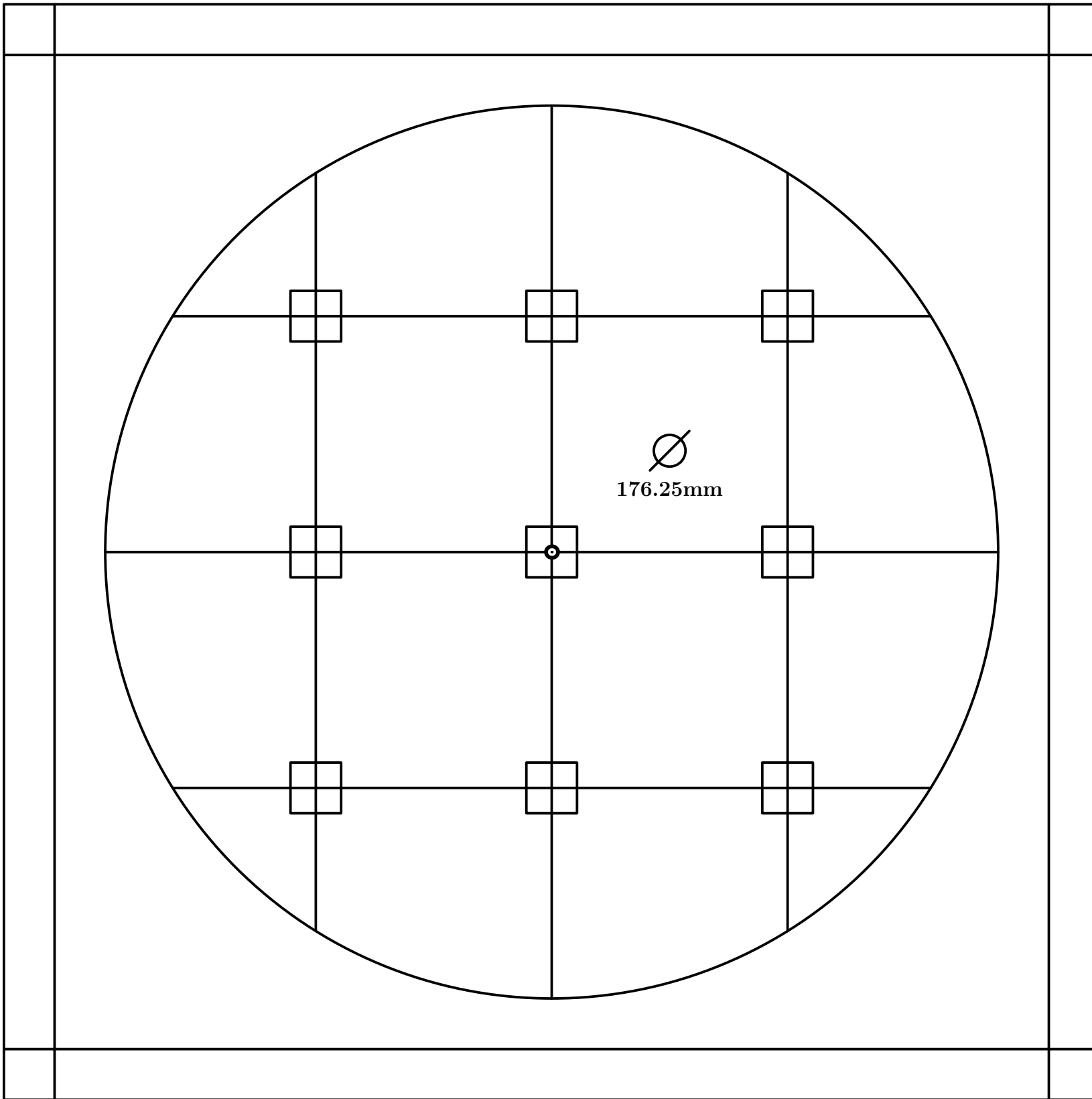

Fig. 306

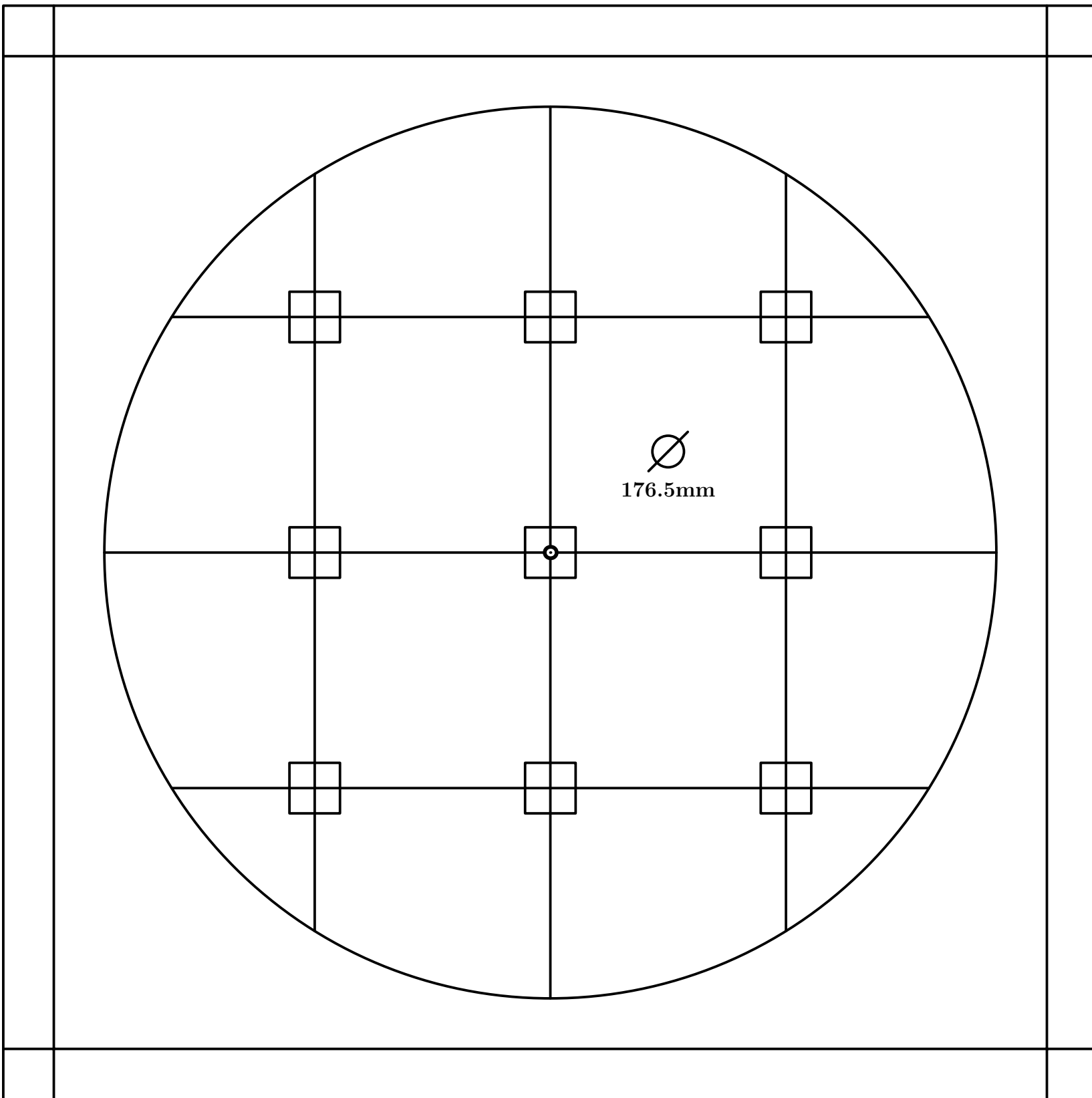

Fig. 307

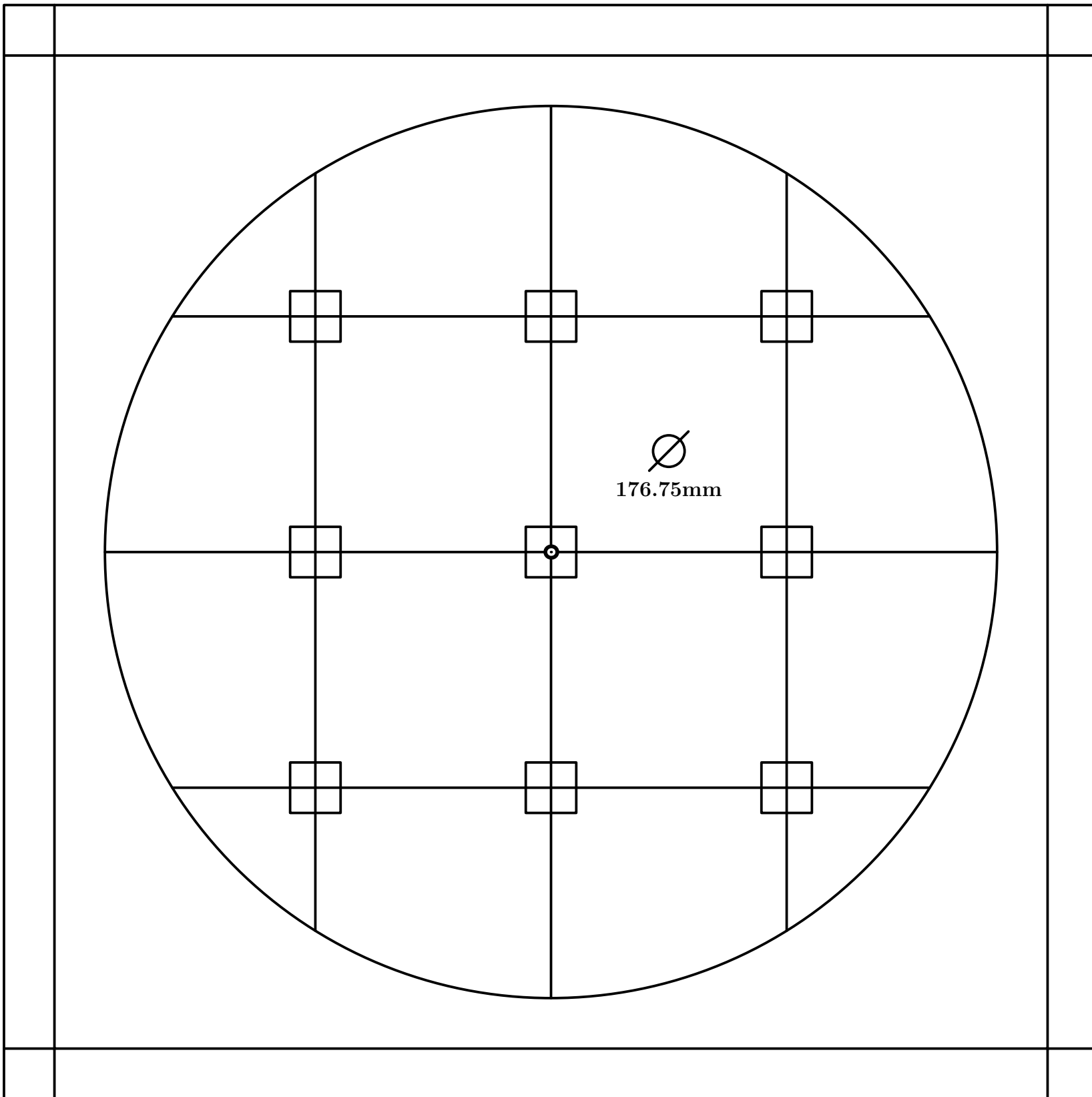

Fig. 308

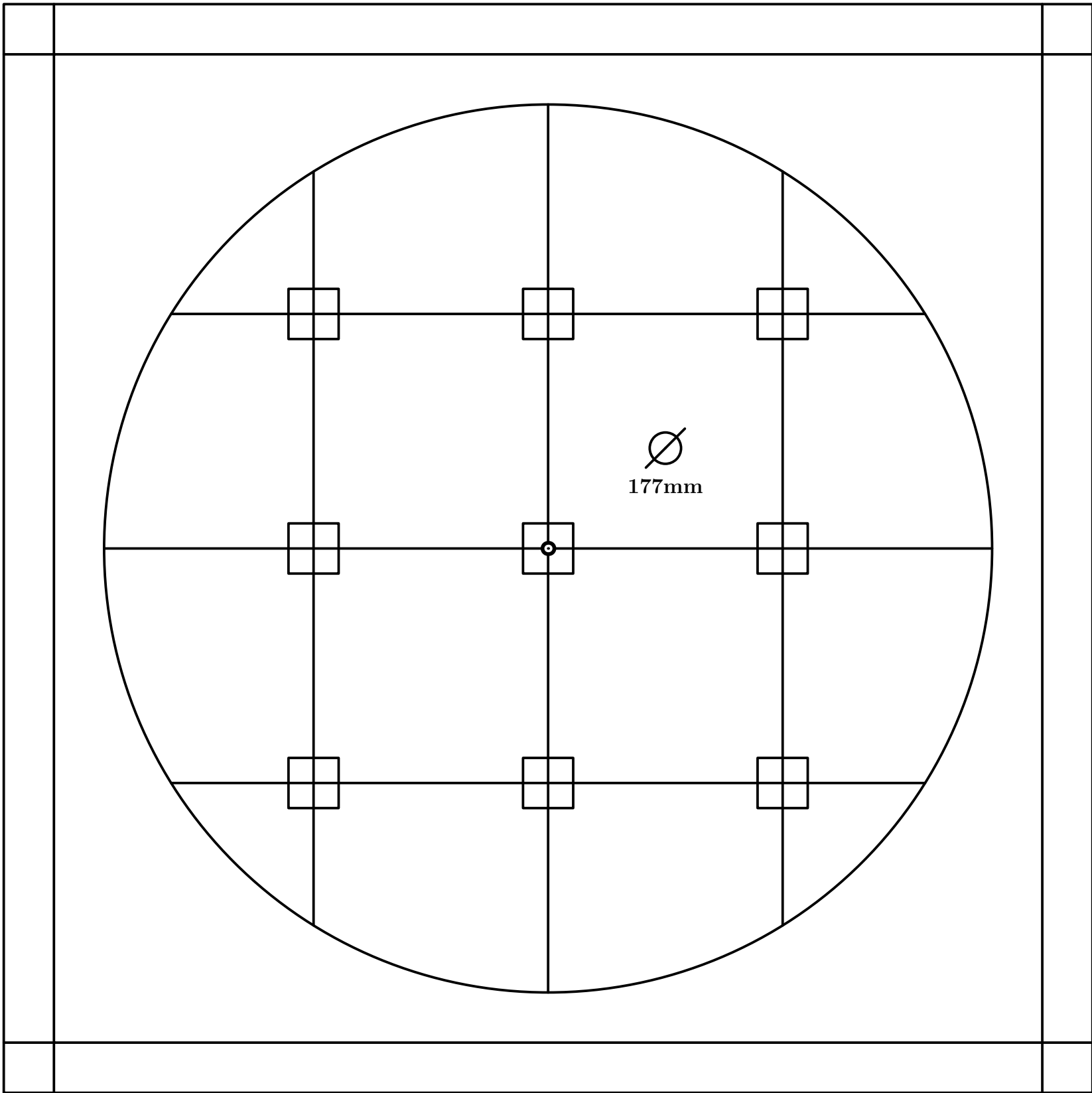

Fig. 309

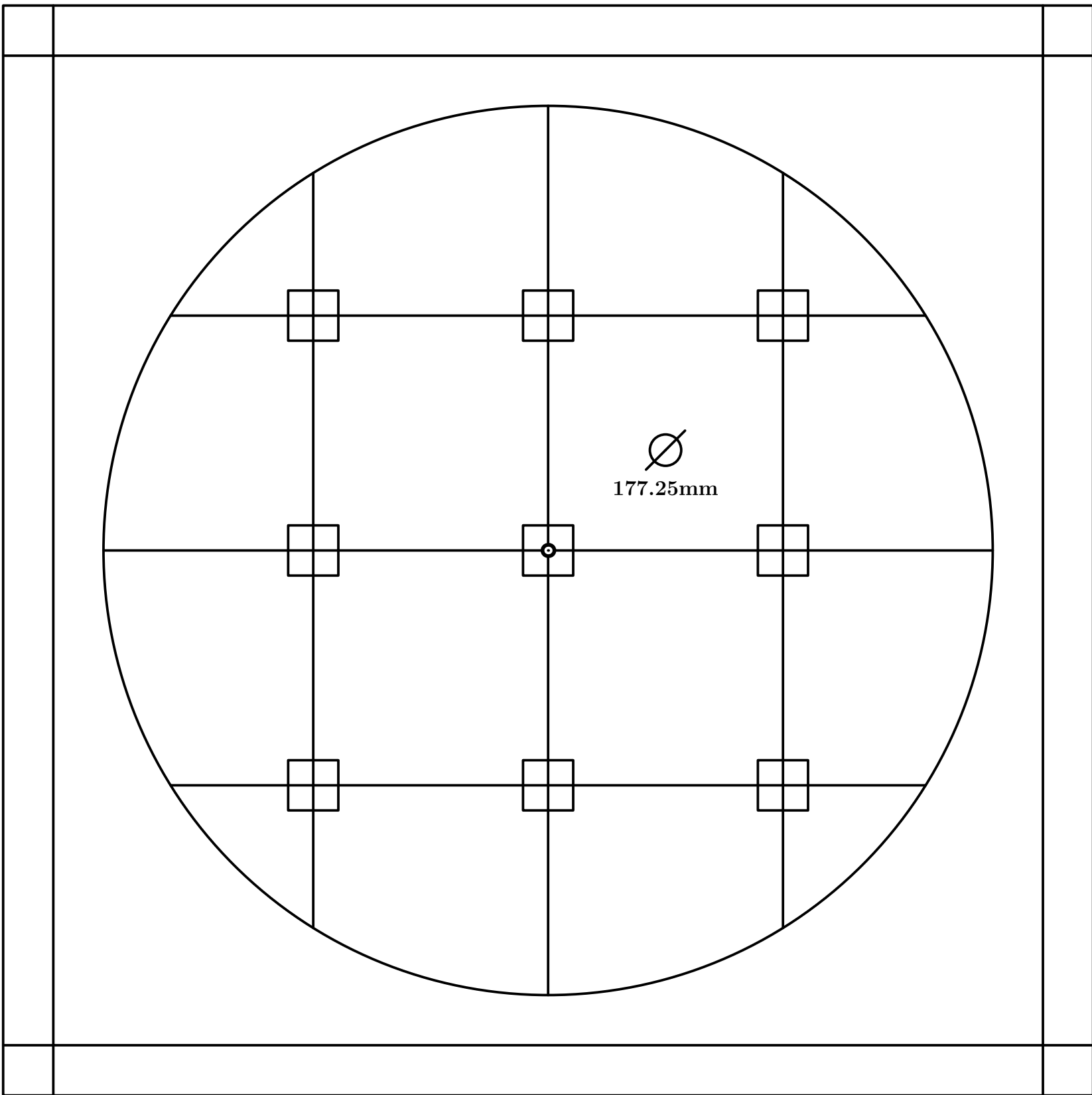

Fig. 310

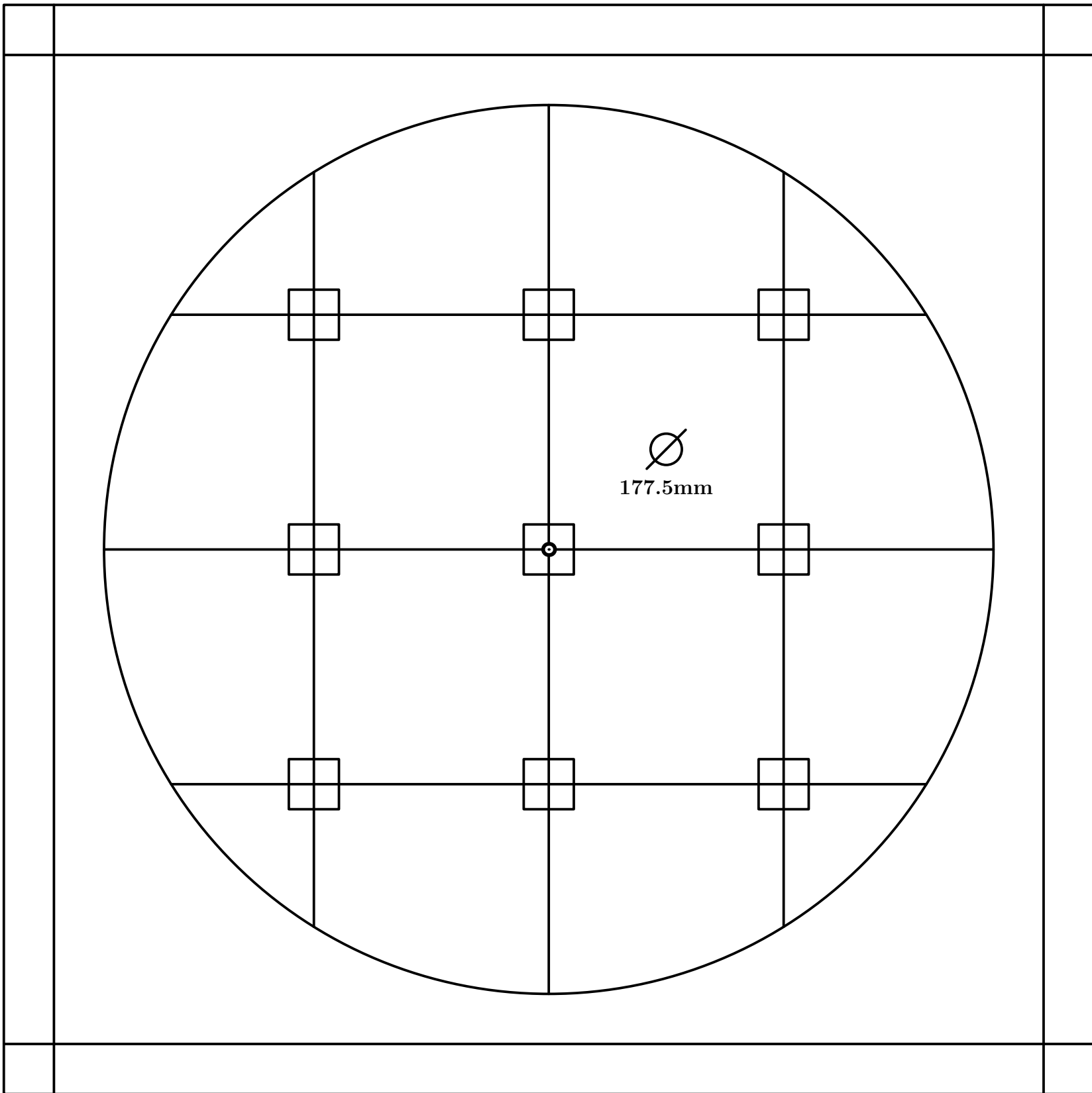

Fig. 311

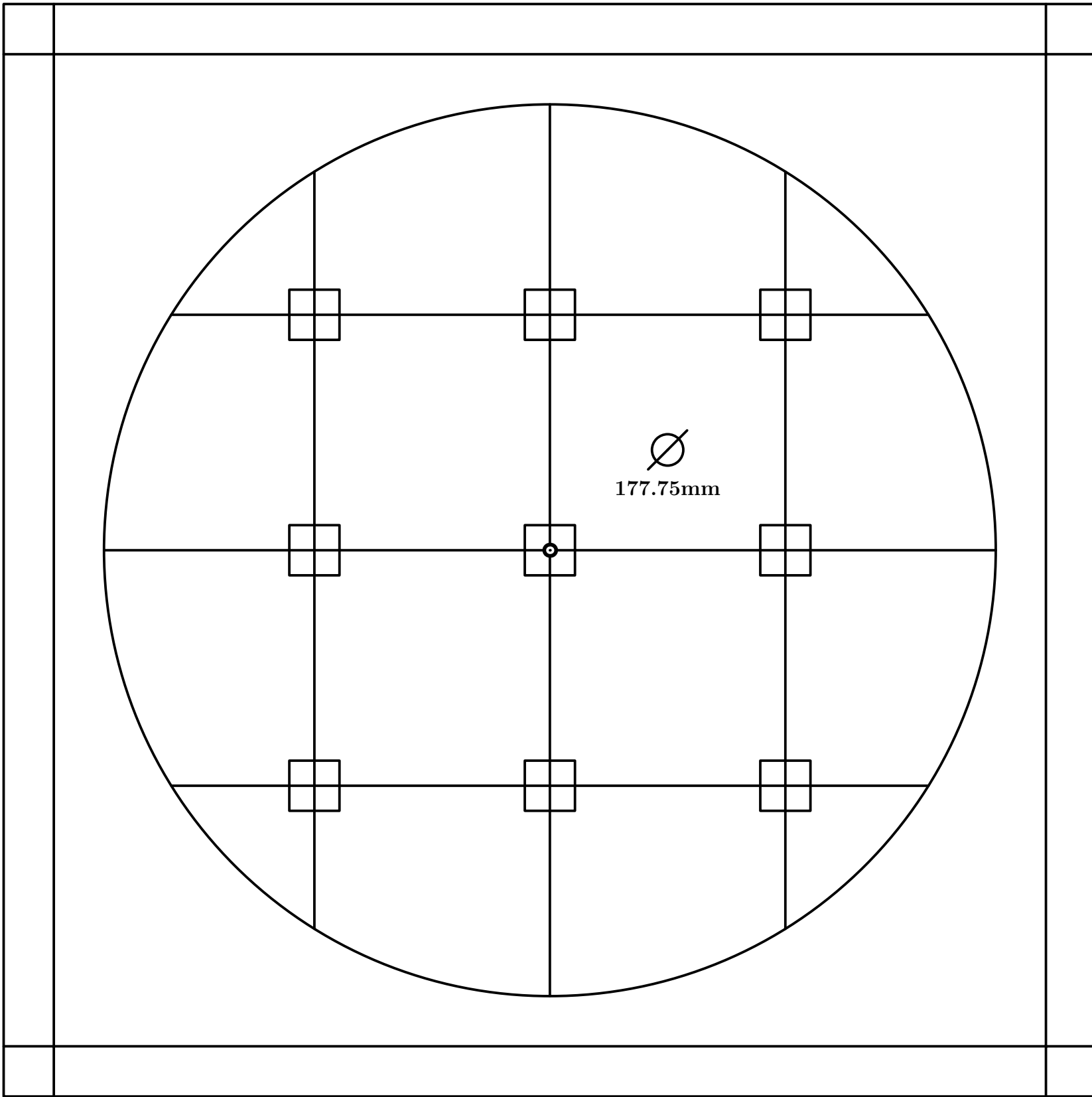

Fig. 312

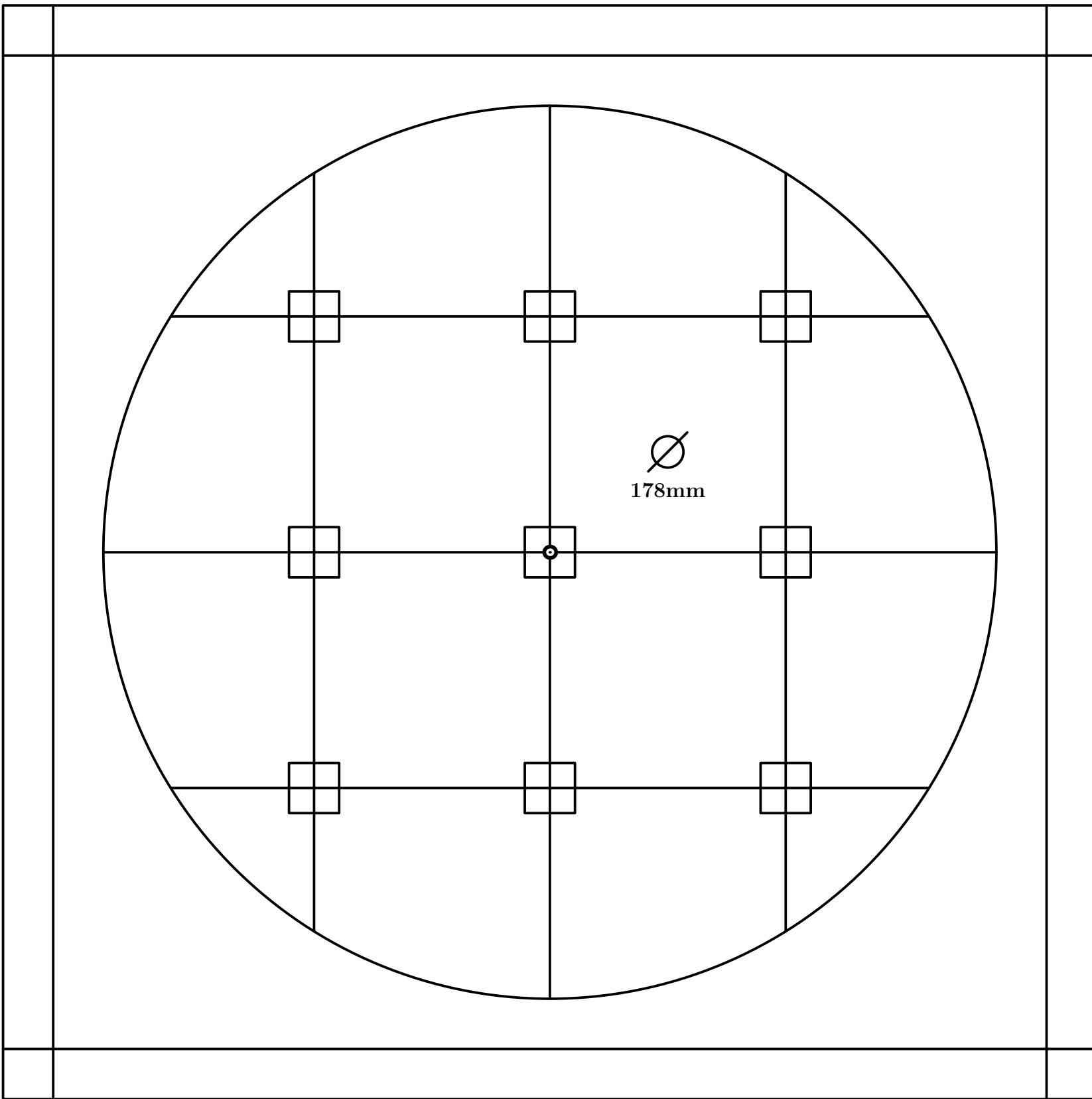

Fig. 313

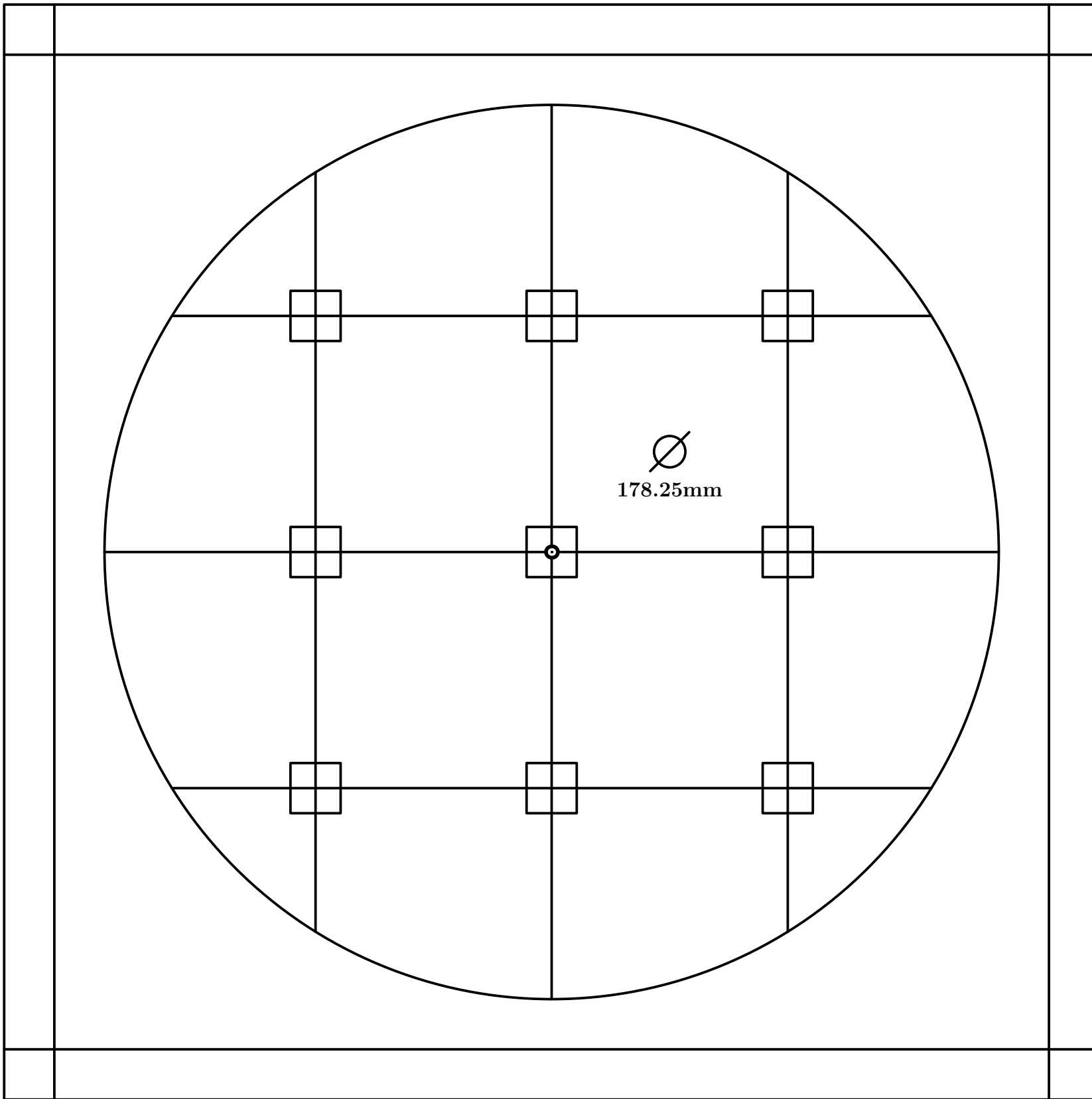

Fig. 314

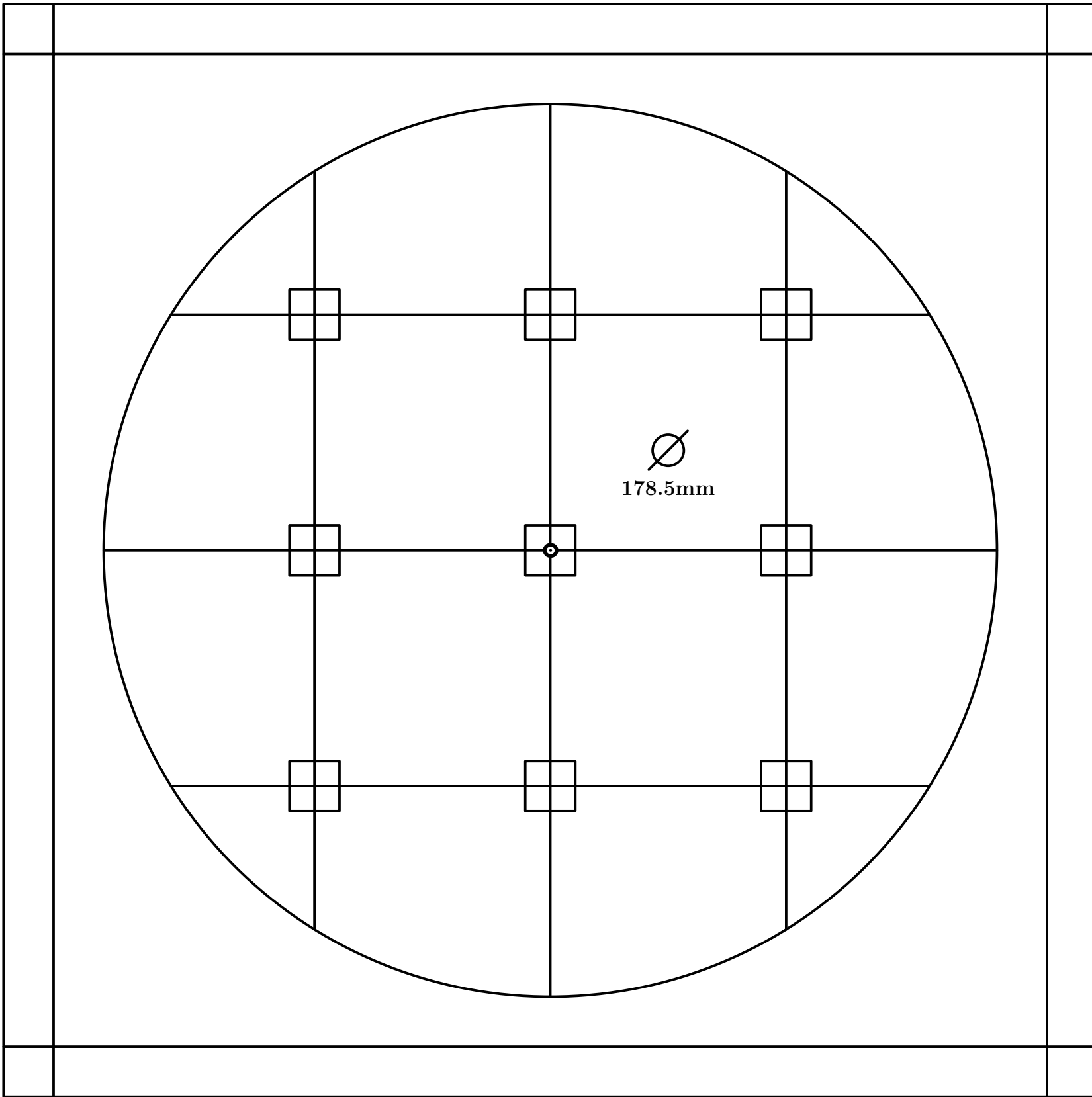

Fig. 315

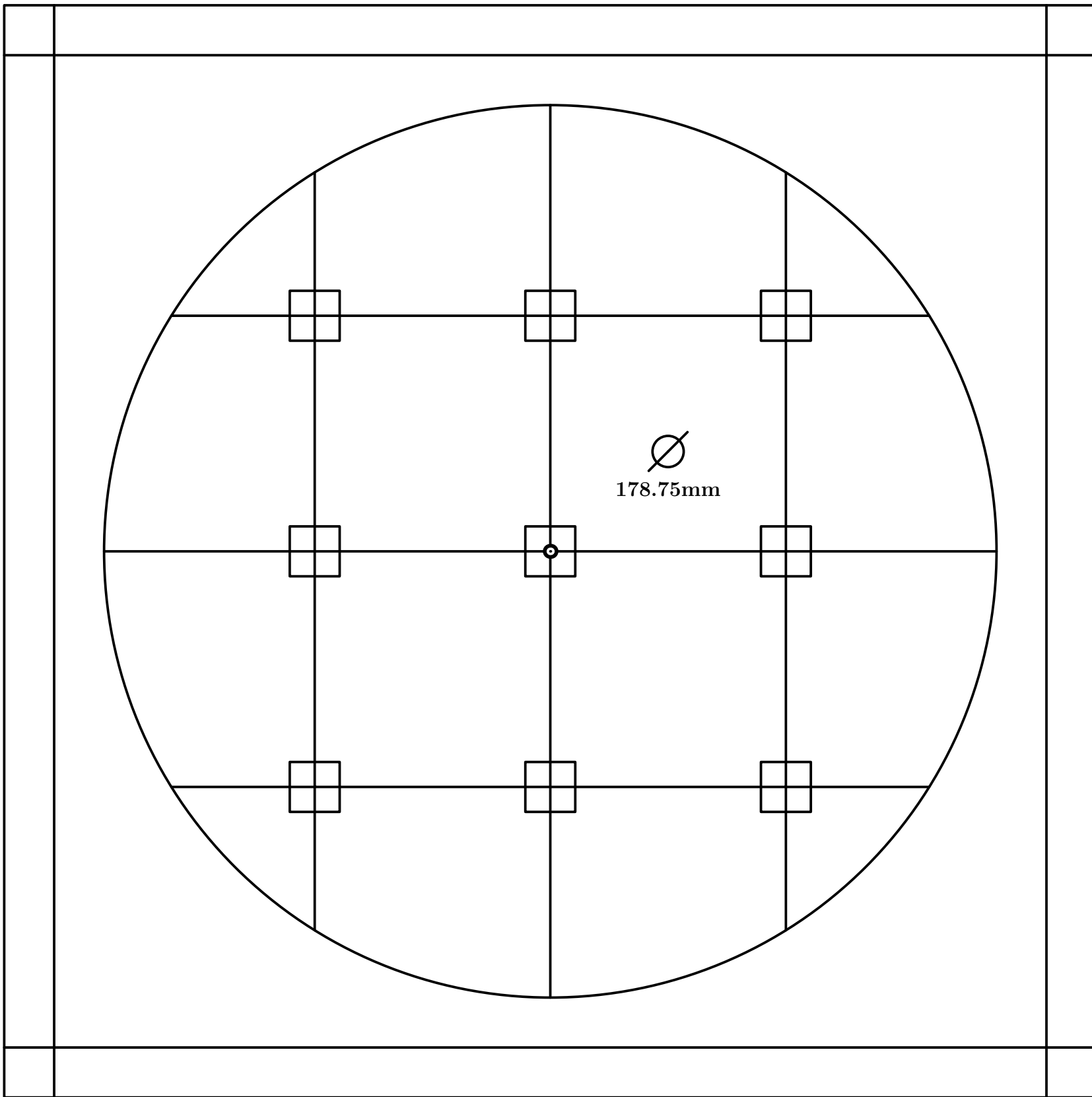

Fig. 316

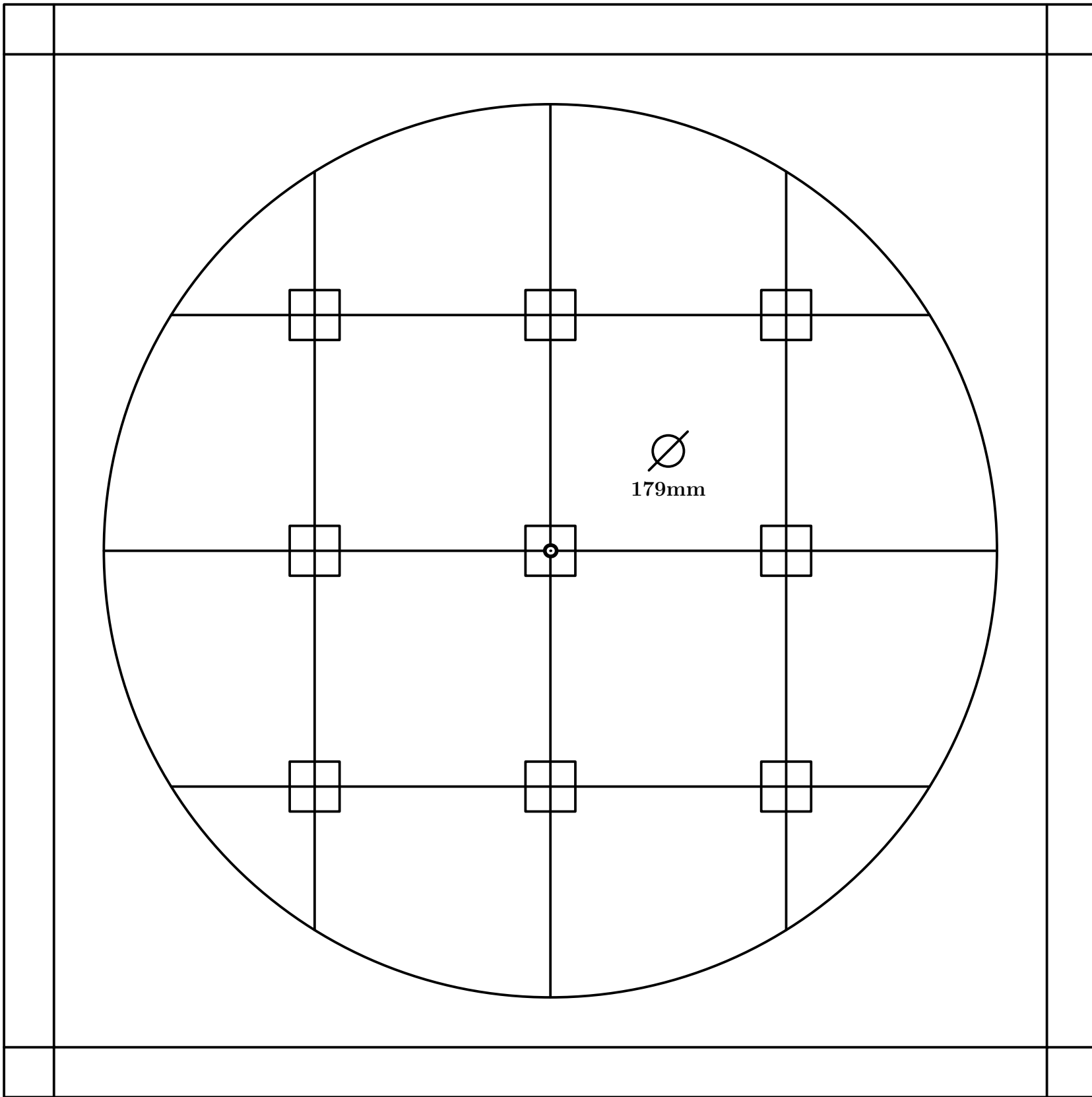

Fig. 317

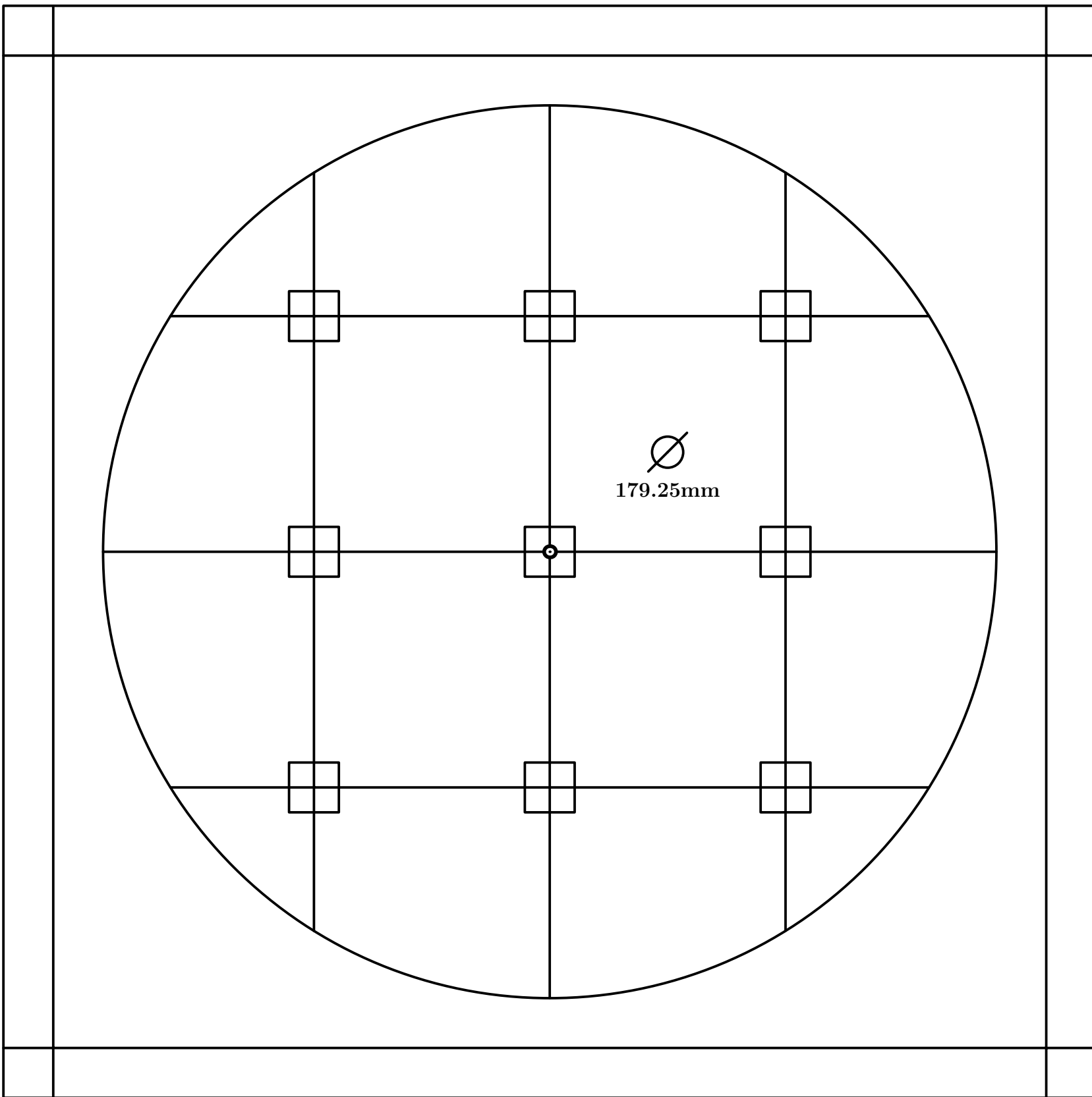

Fig. 318

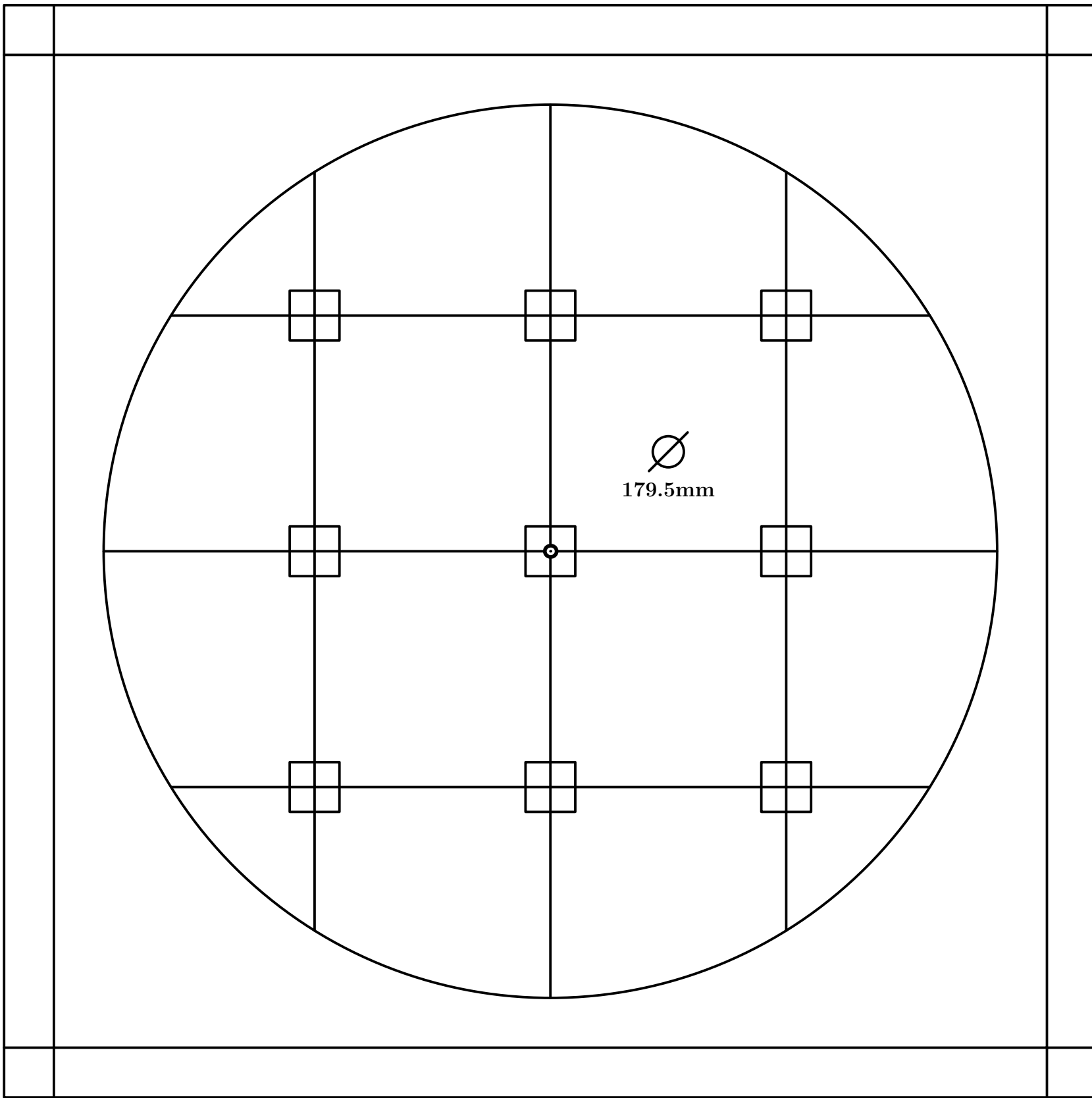

Fig. 319

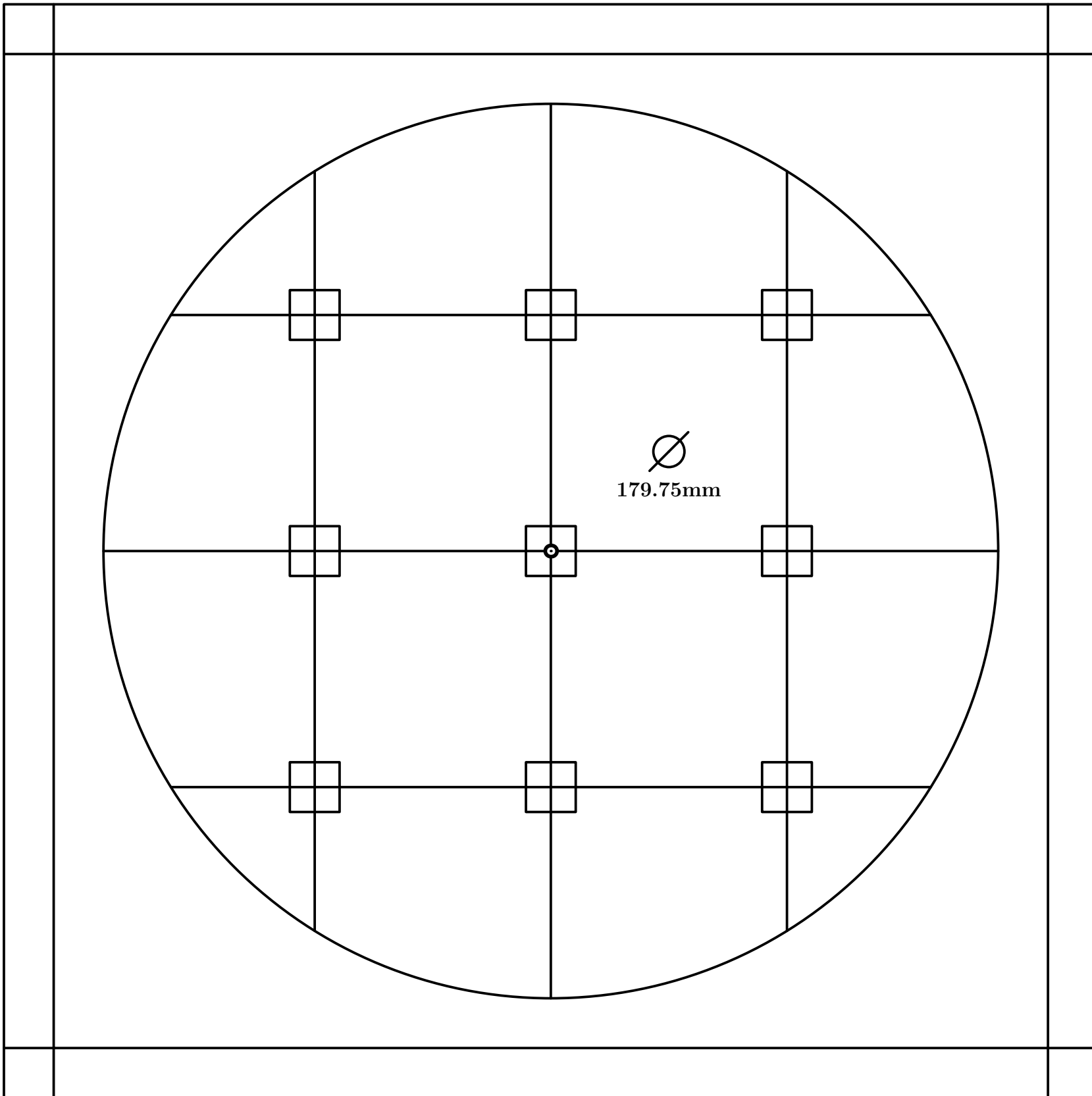

Fig. 320

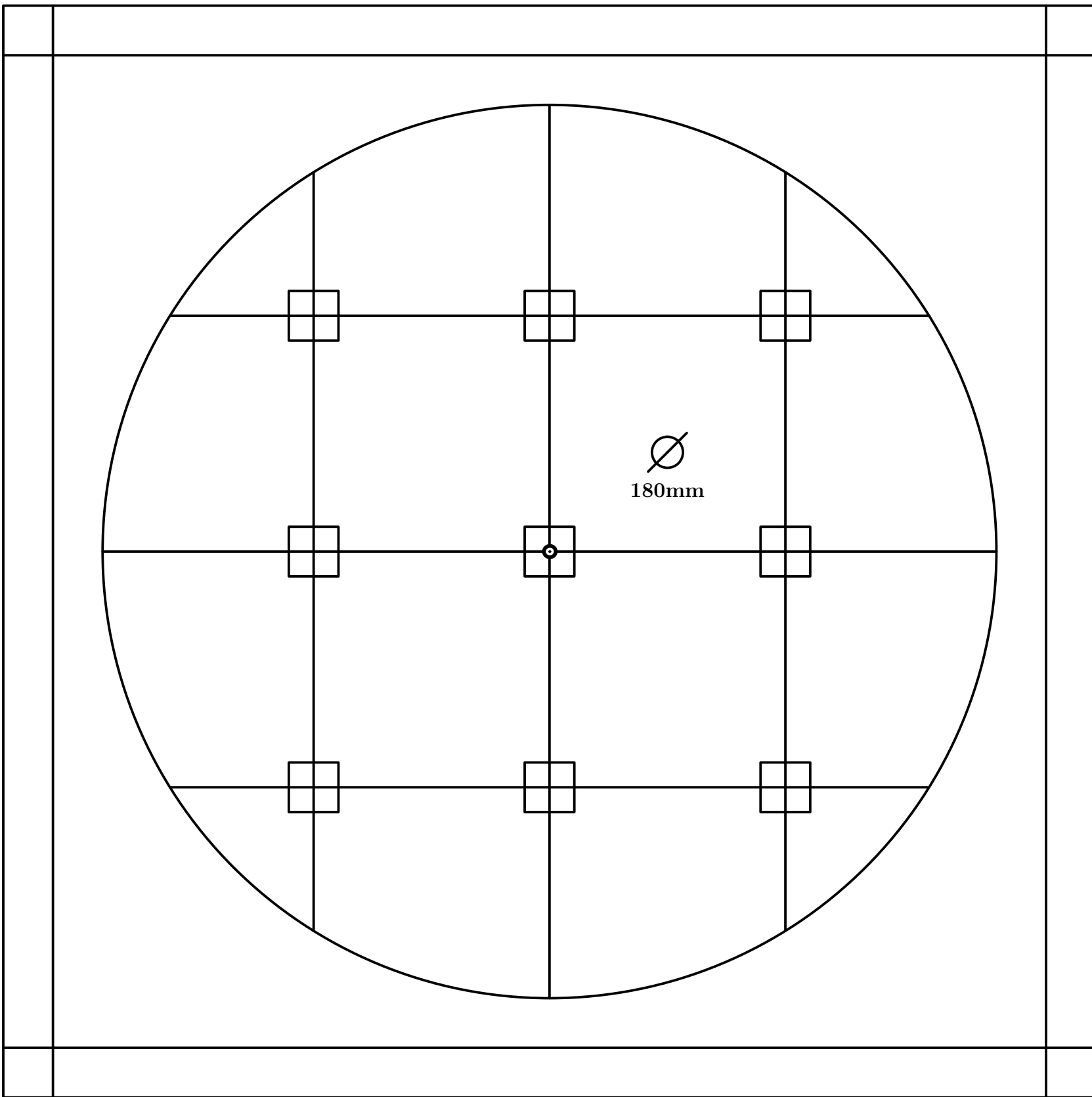

Fig. 321

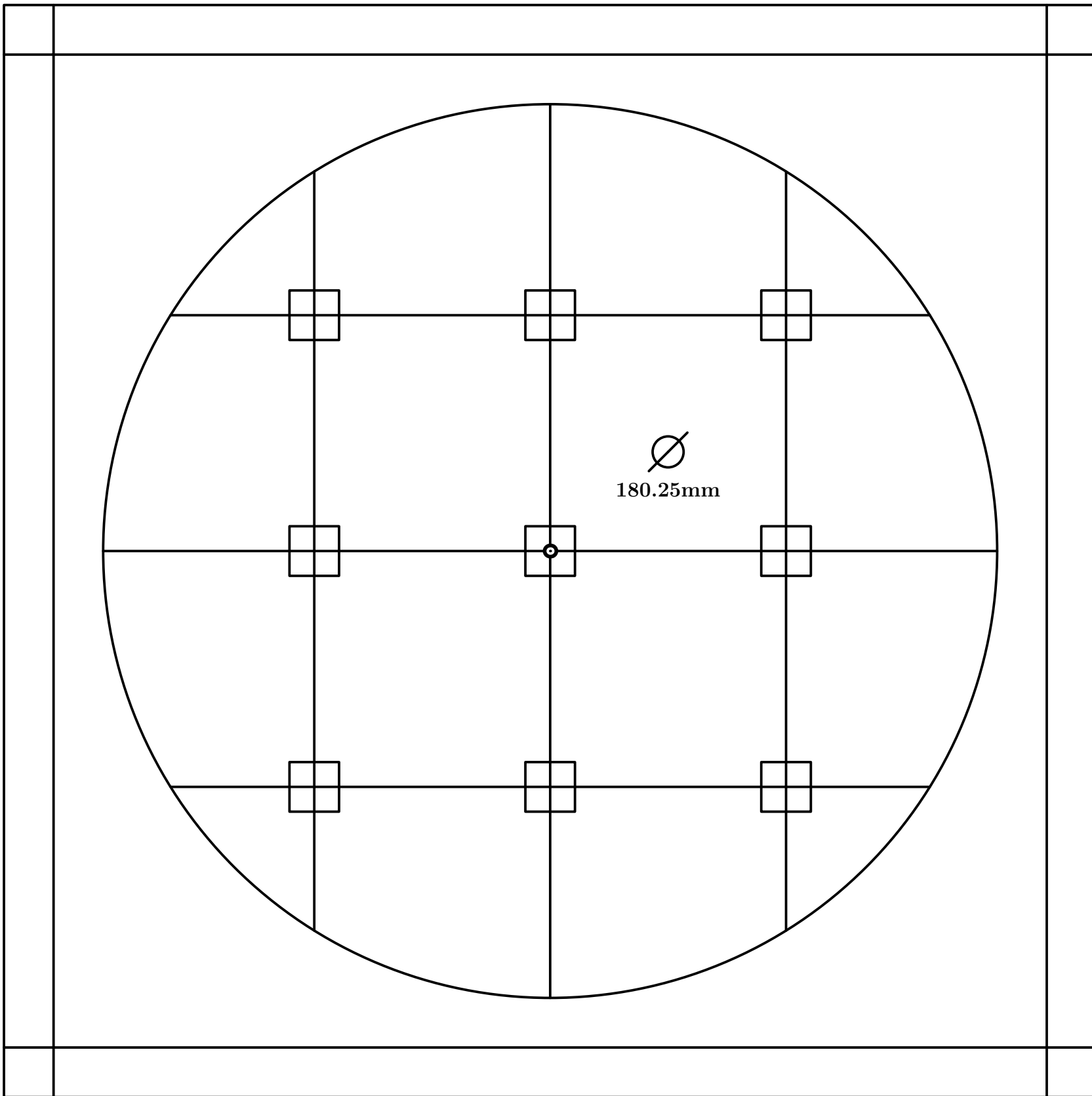

Fig. 322

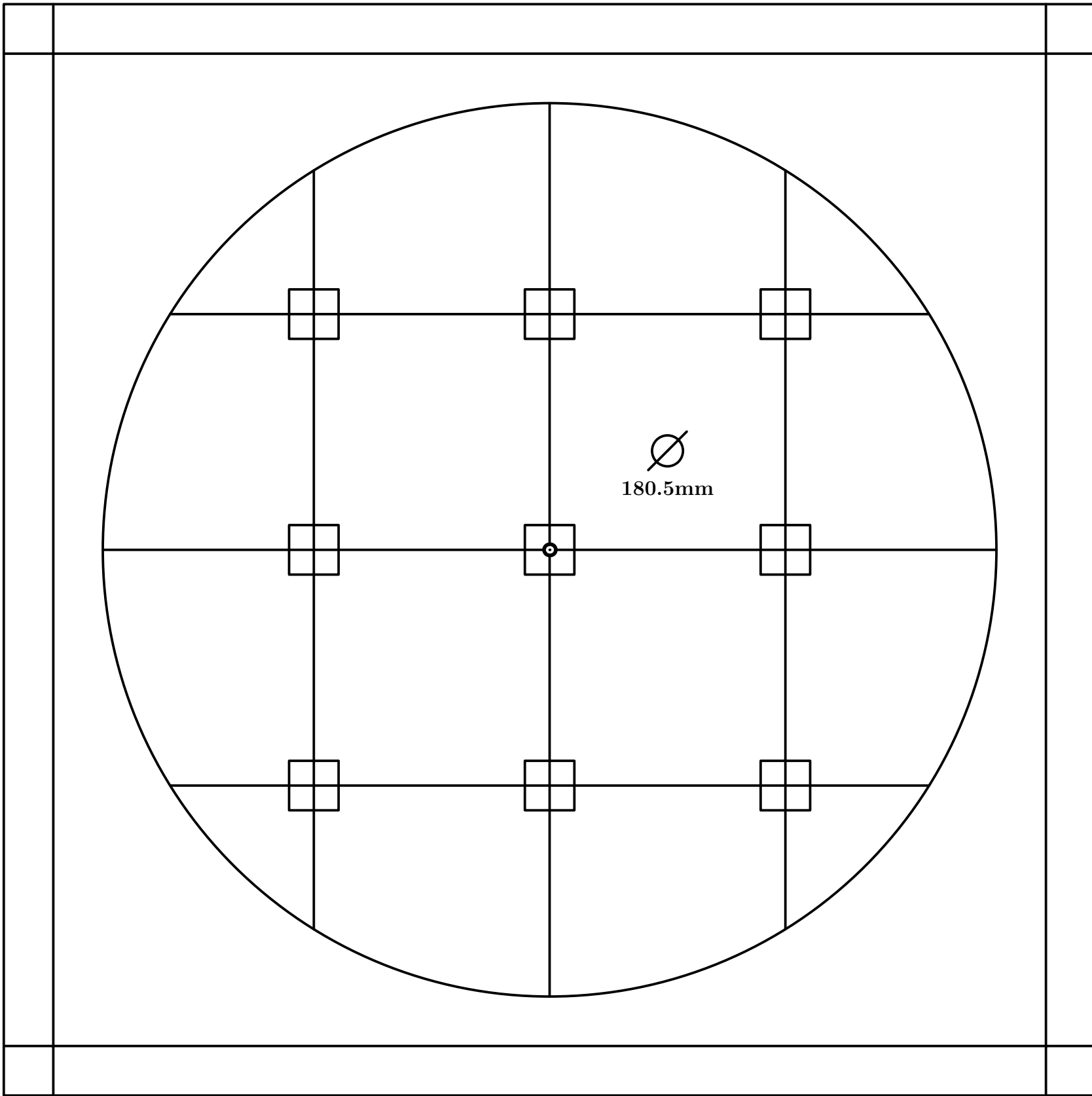

Fig. 323

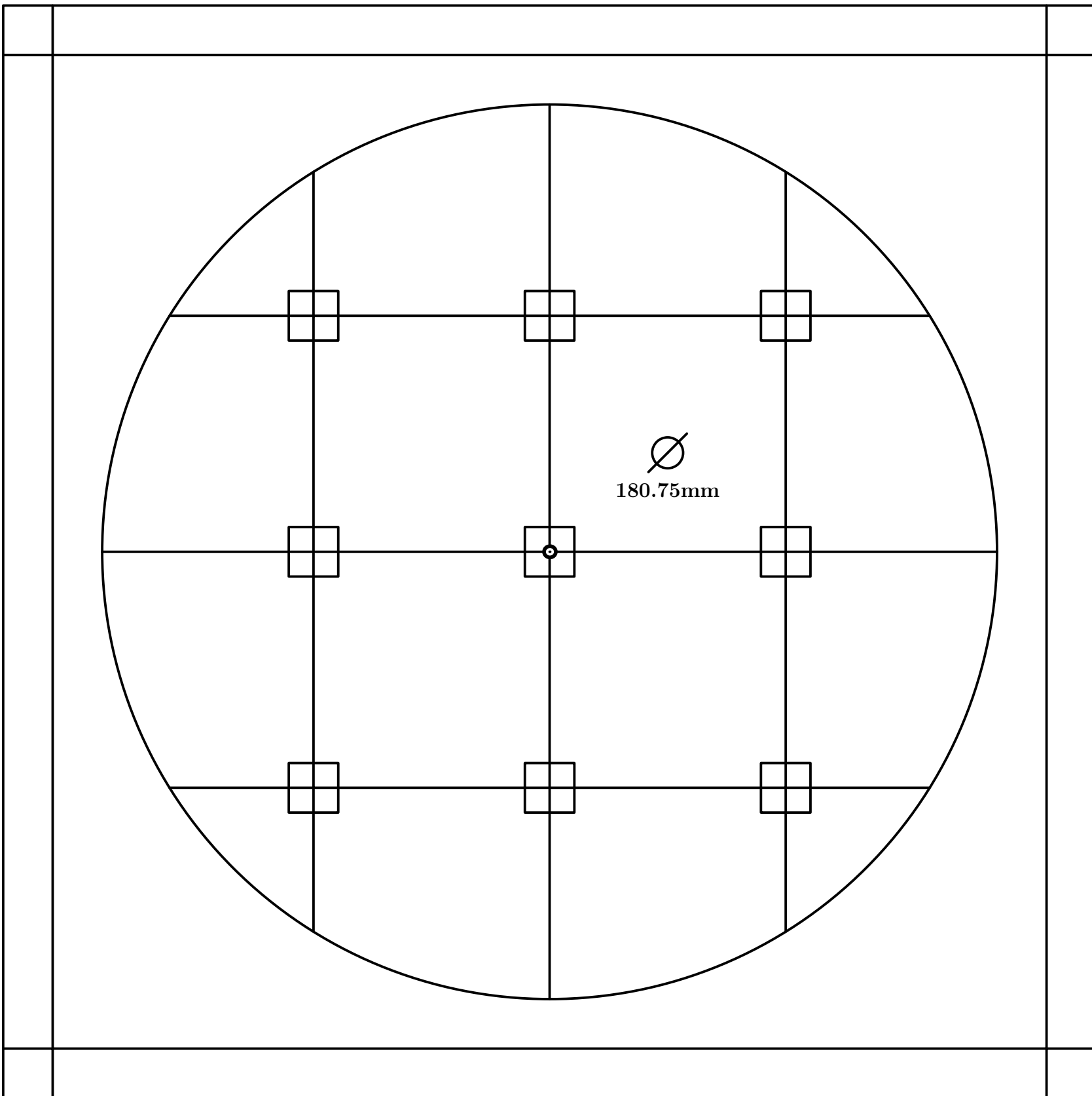

Fig. 324

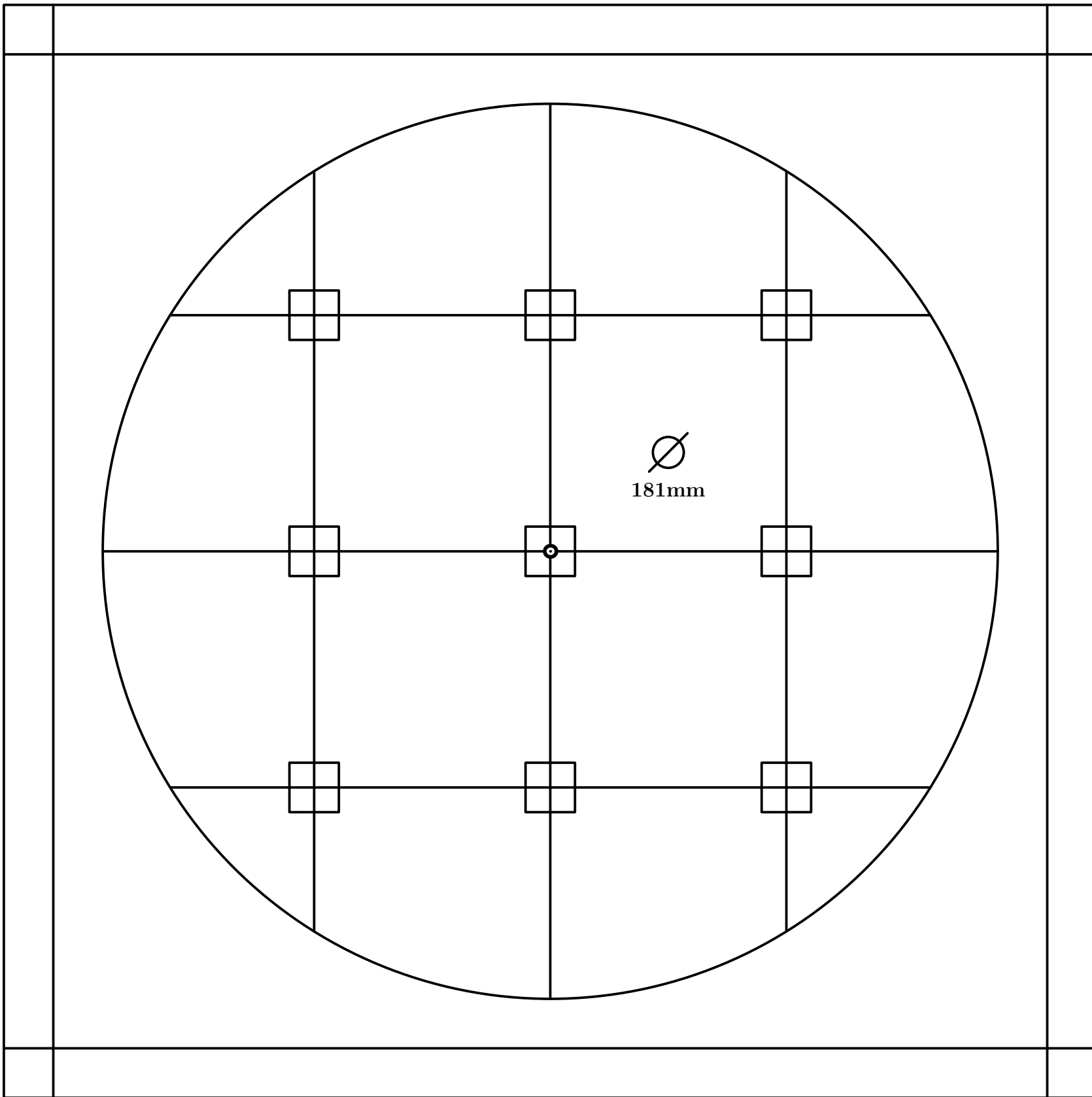

Fig. 325

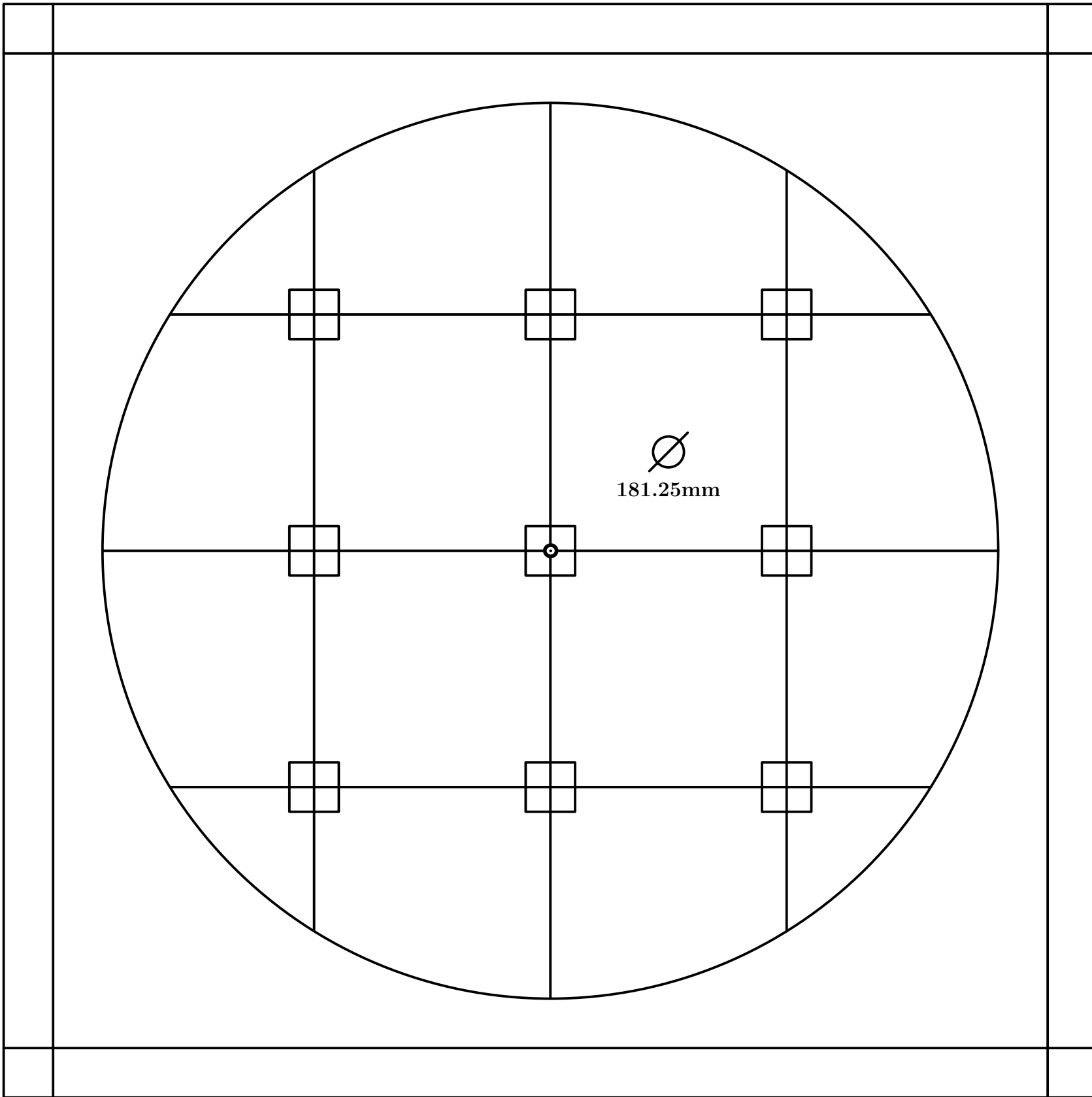

Fig. 326

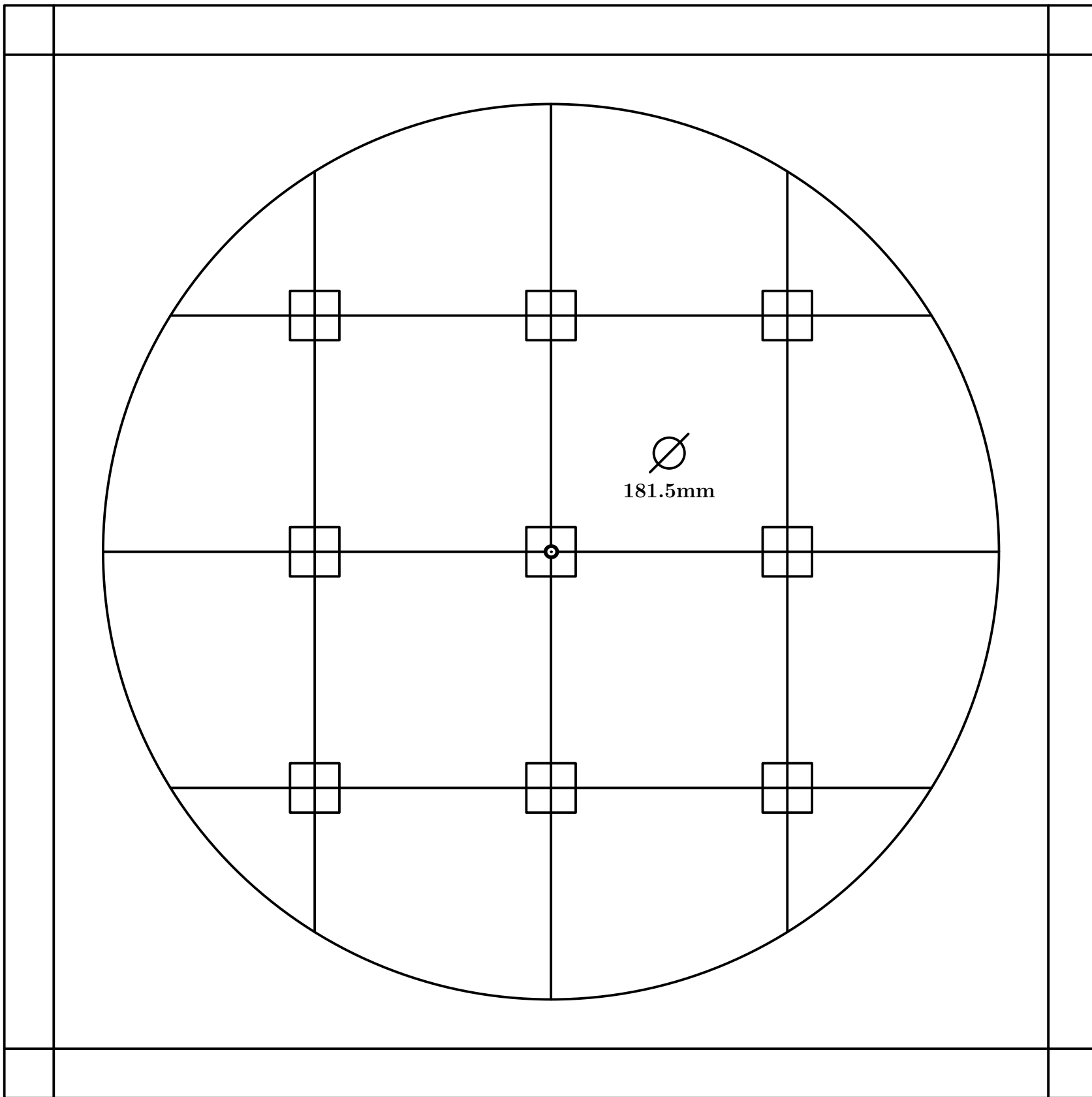

Fig. 327

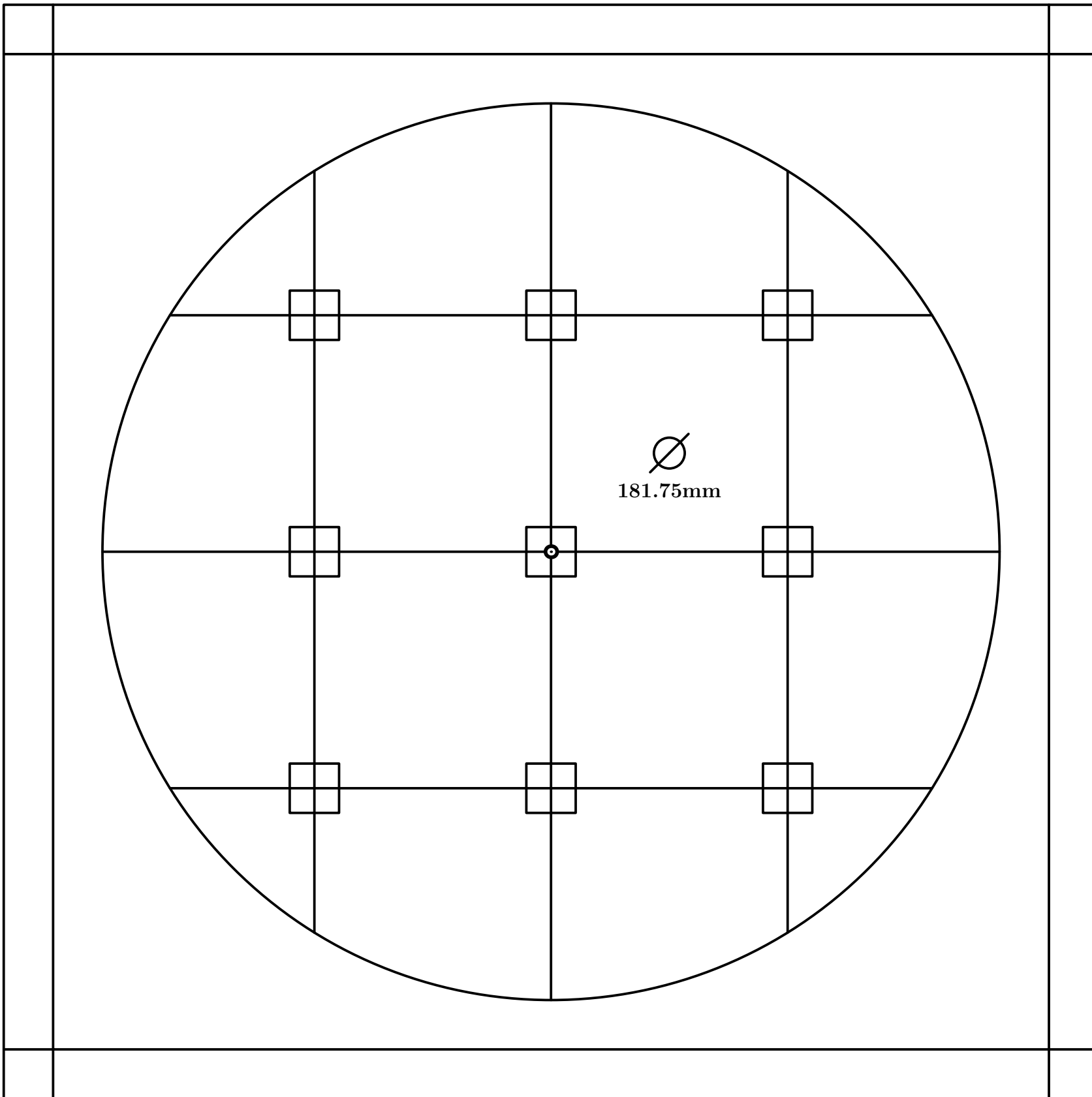

Fig. 328

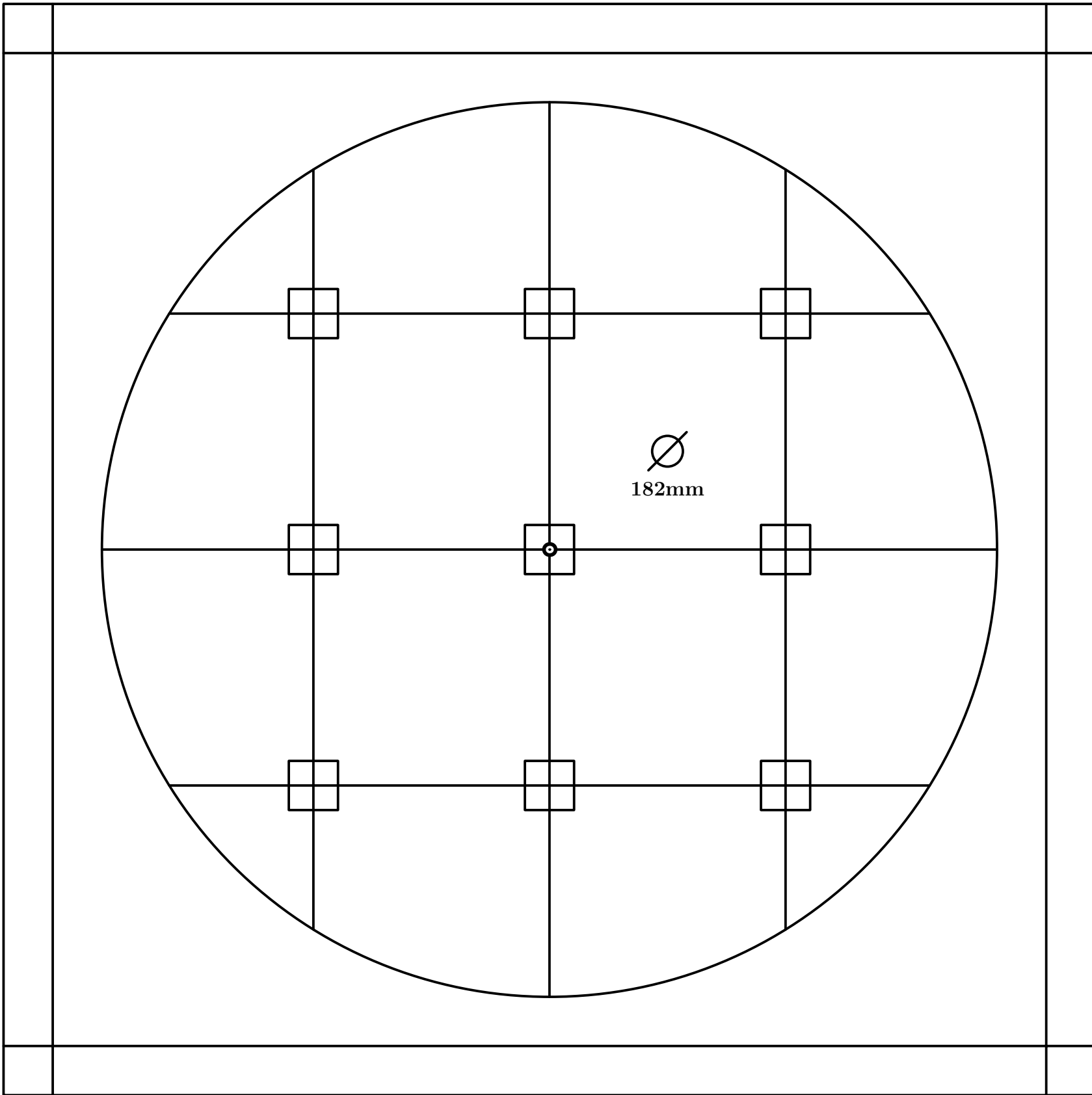

Fig. 329

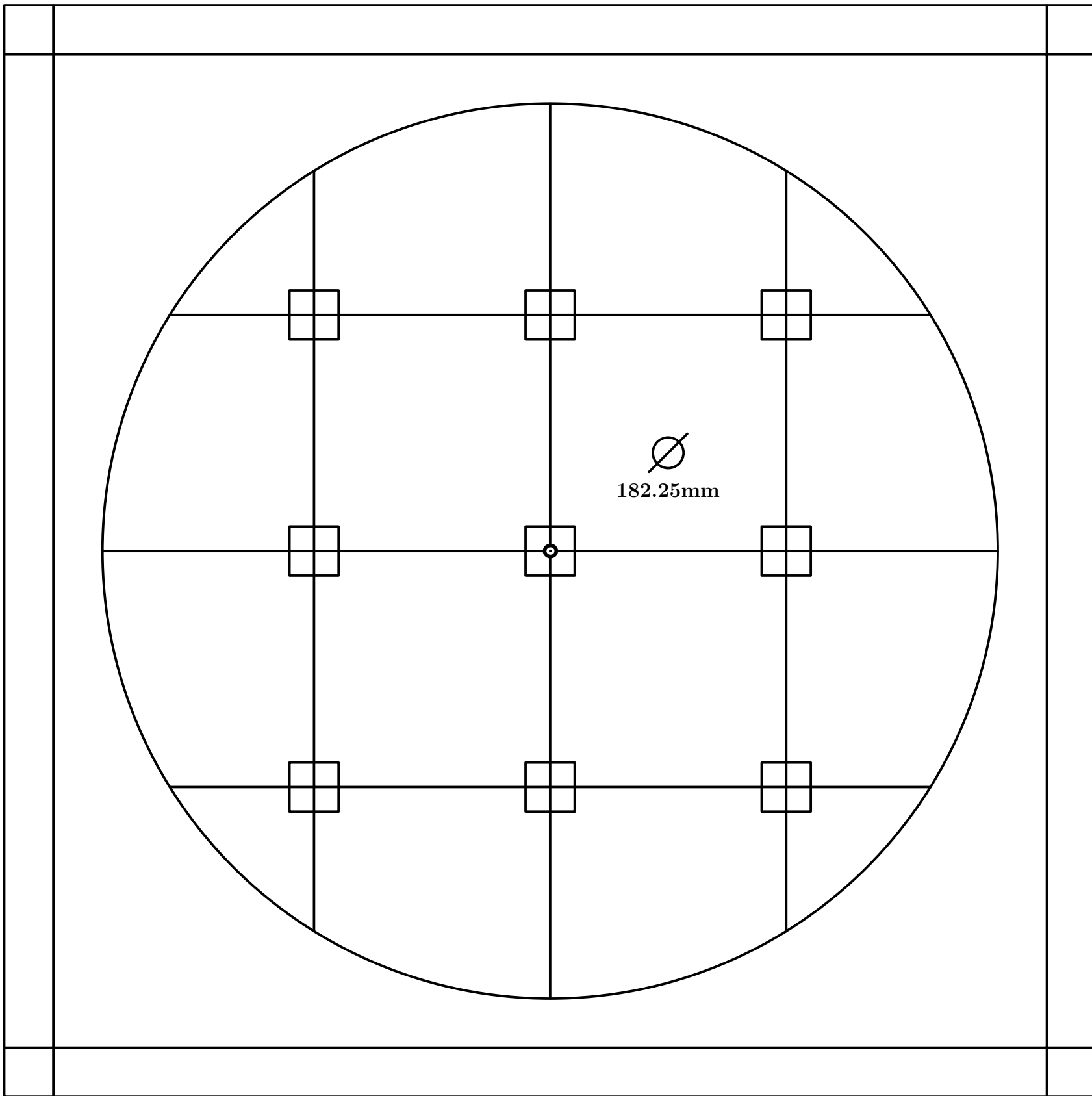

Fig. 330

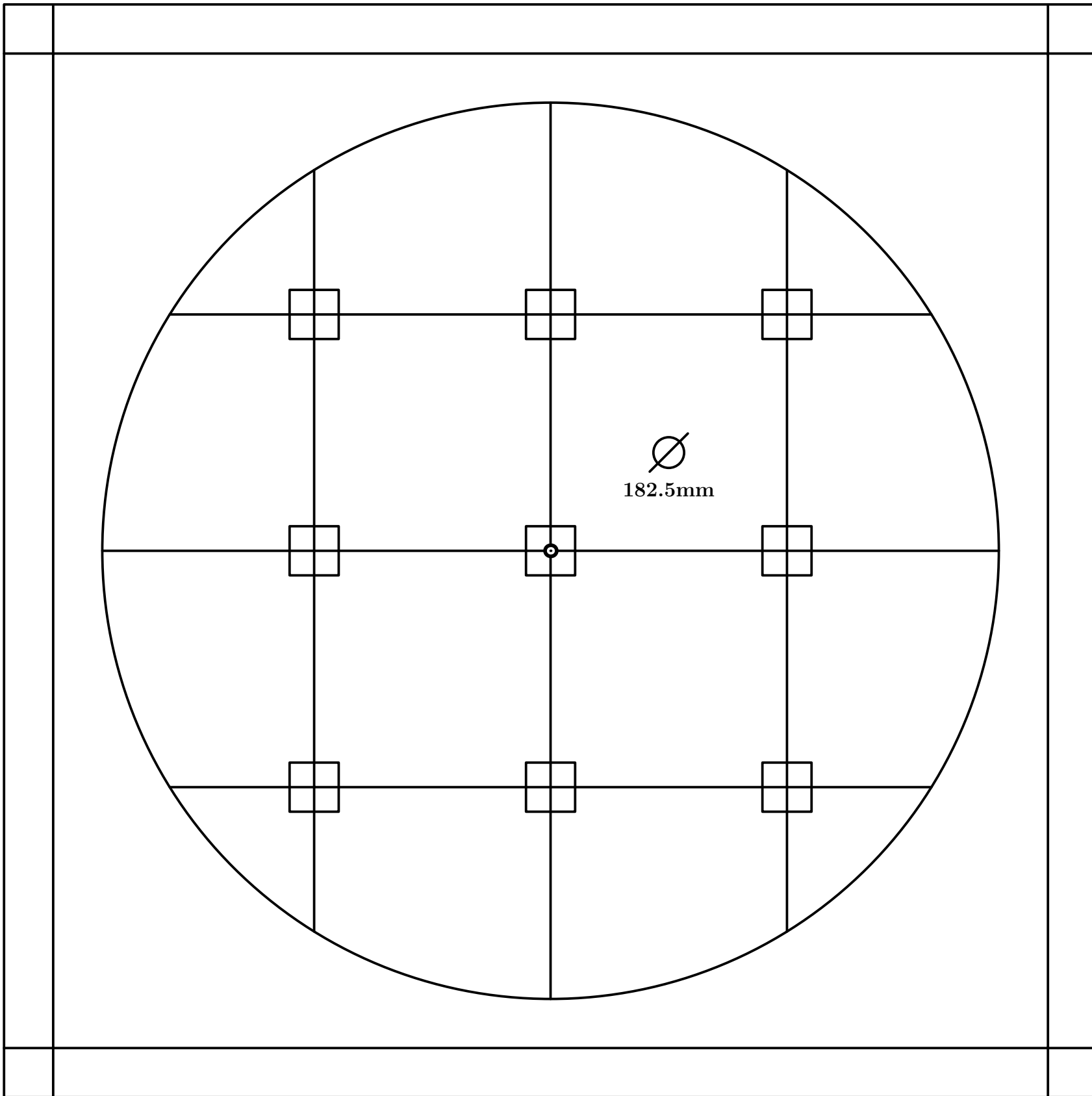

Fig. 331

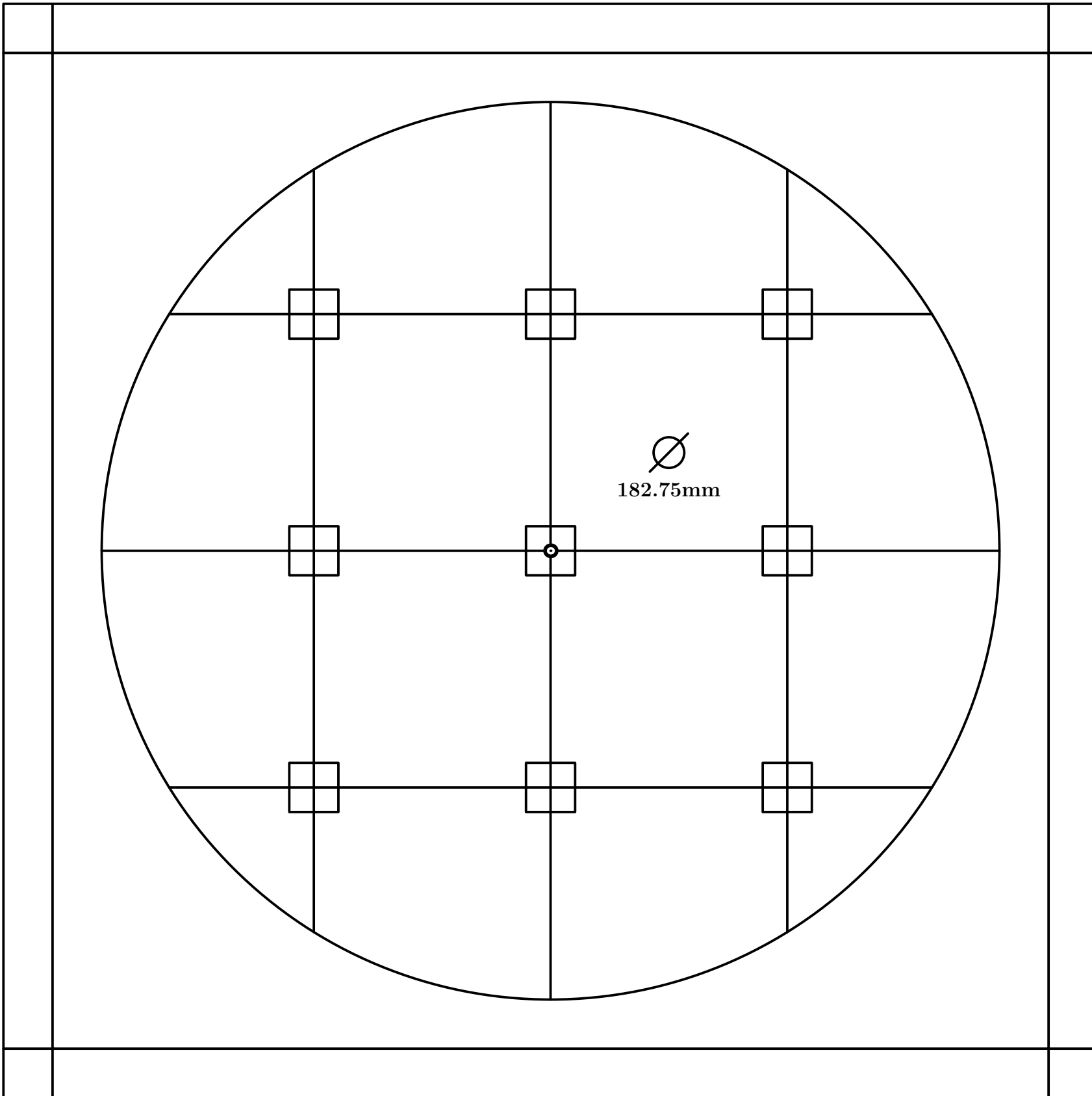

Fig. 332

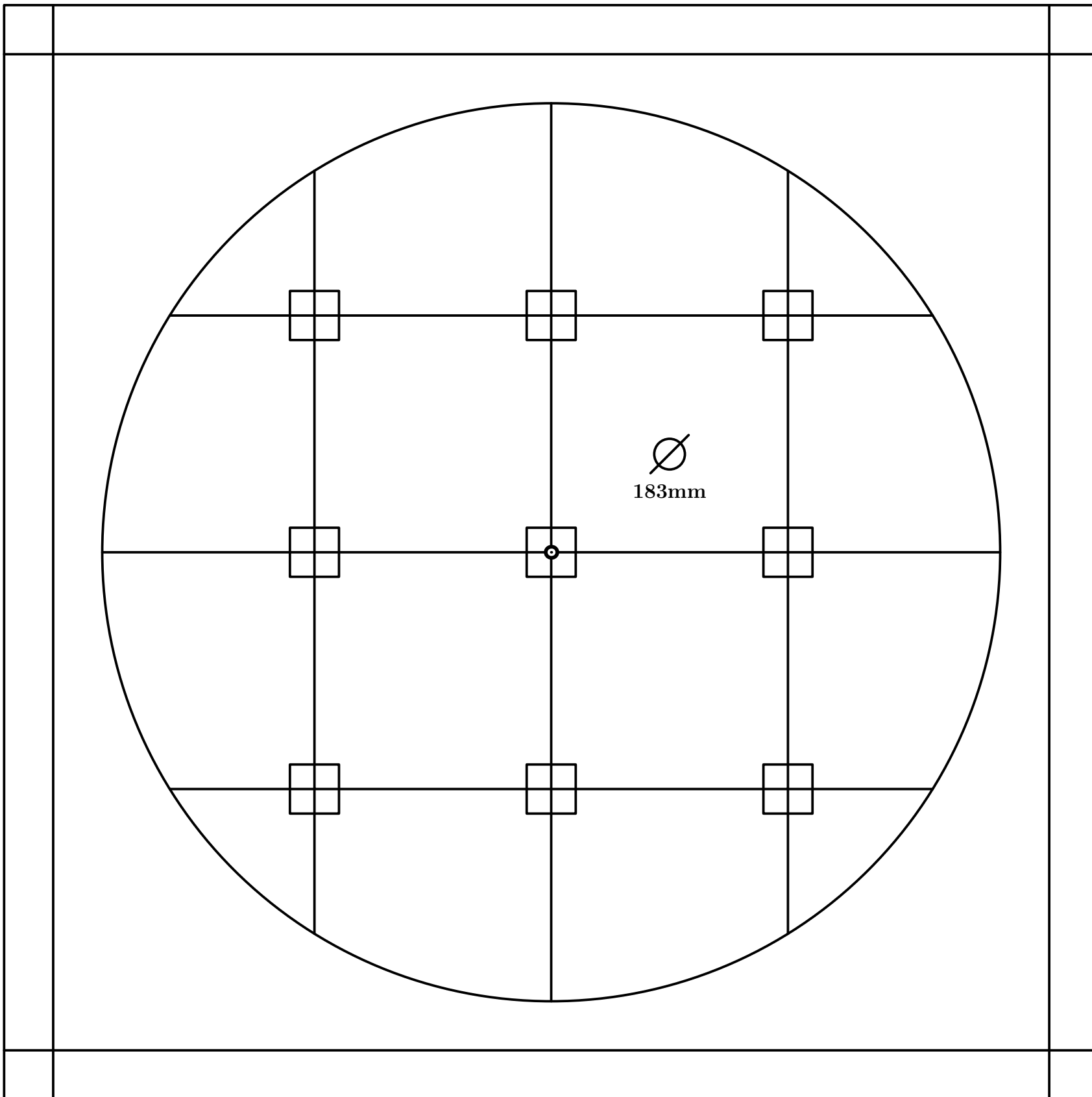

Fig. 333

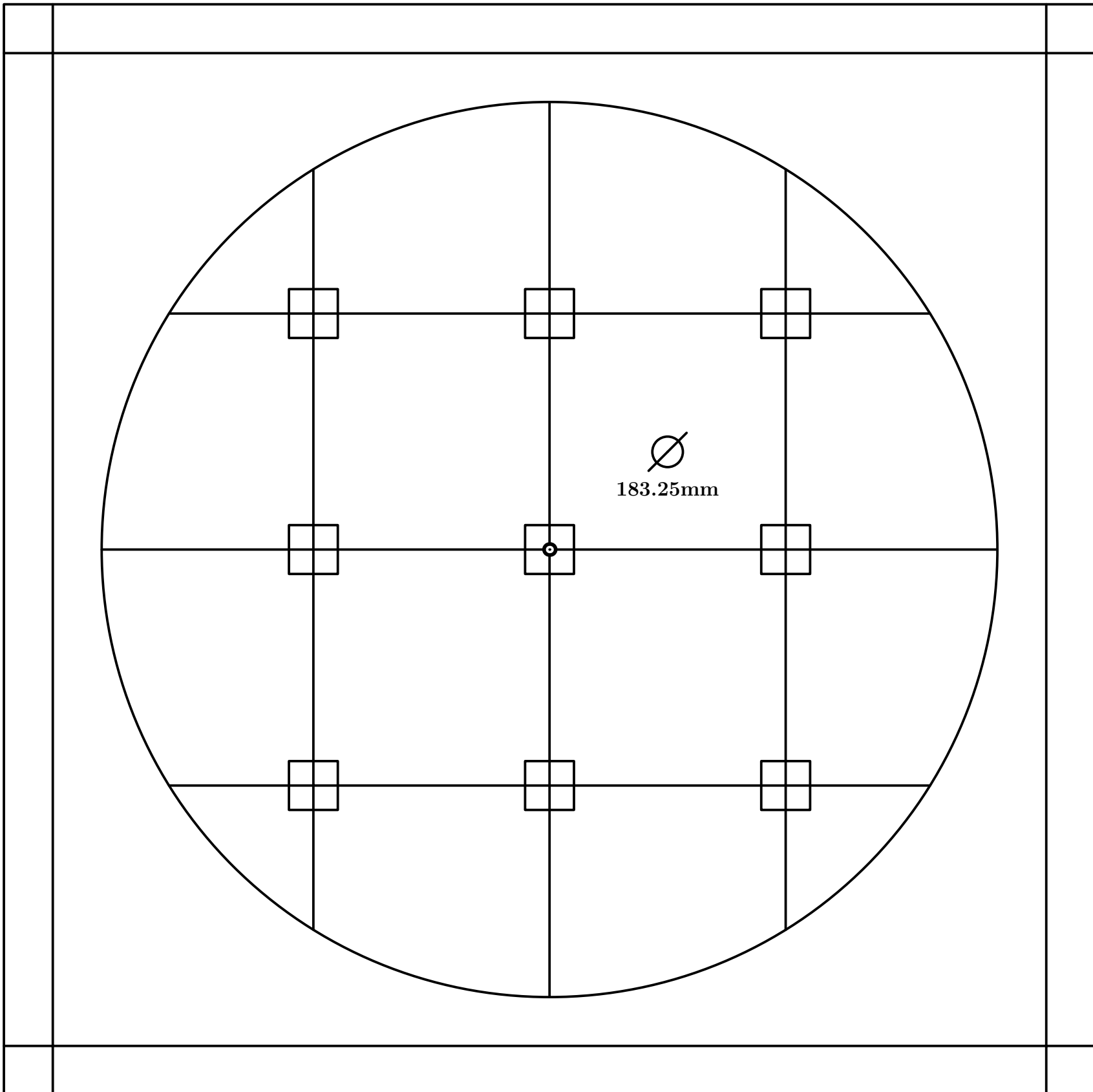

Fig. 334

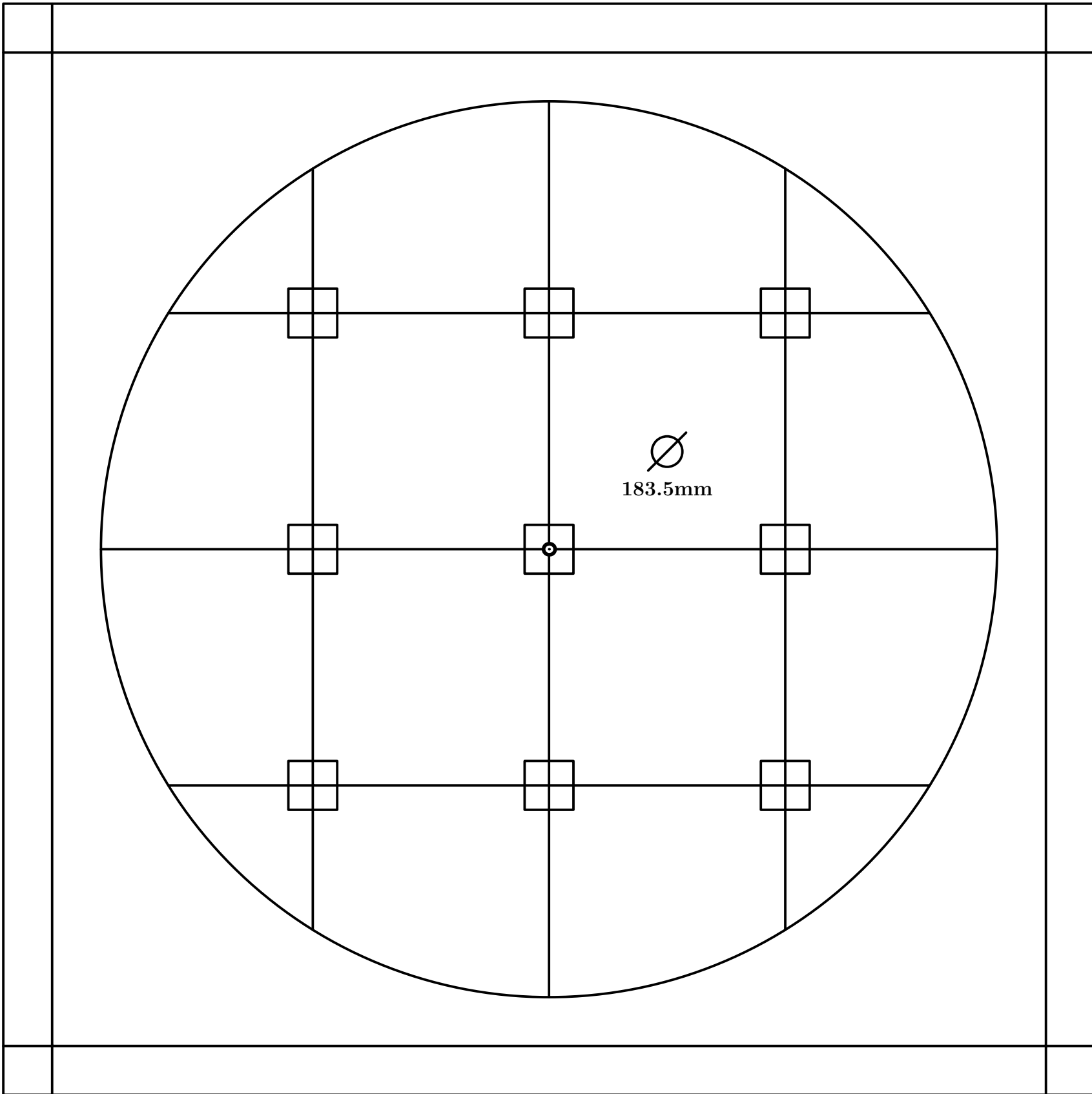

Fig. 335

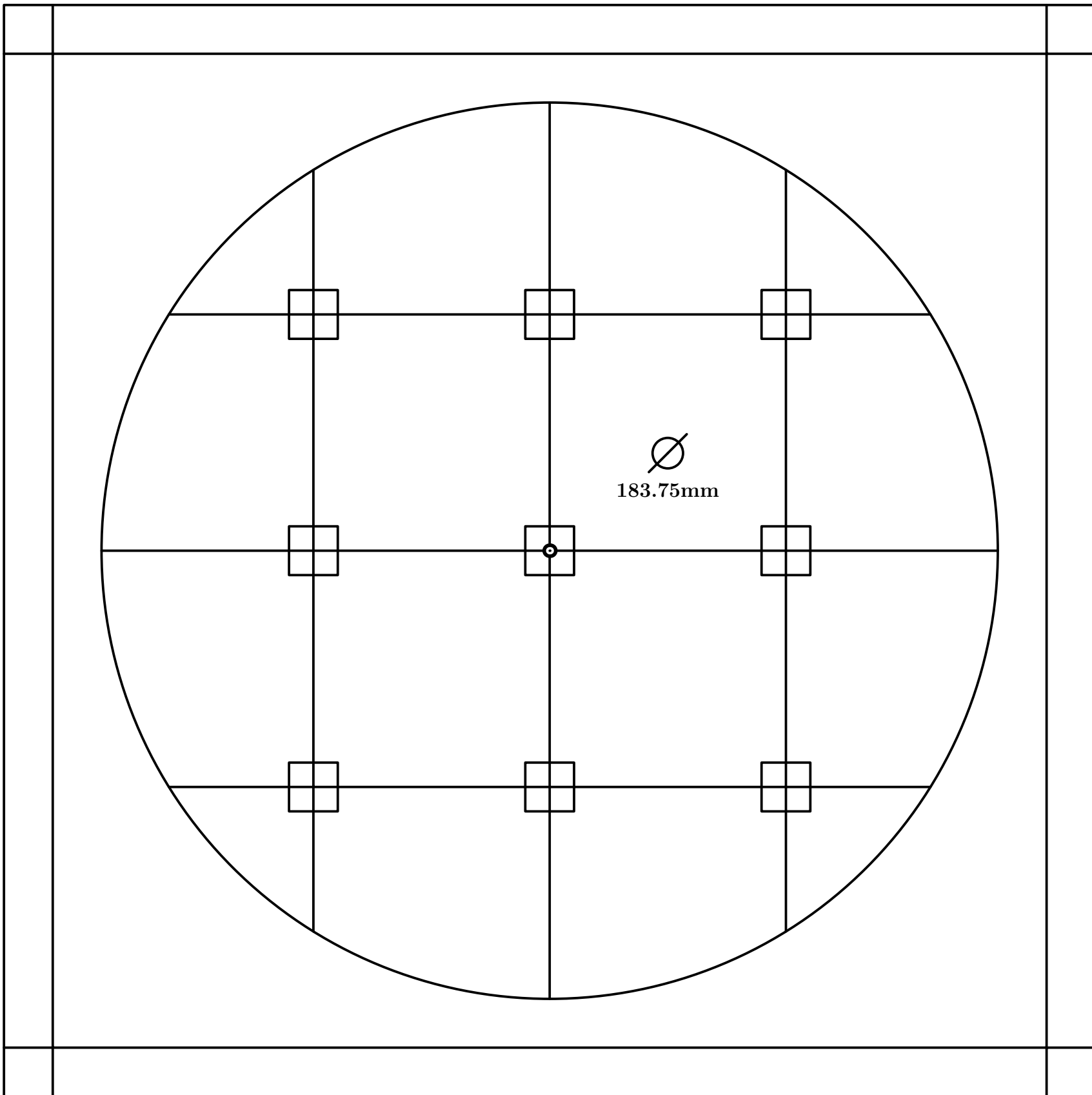

Fig. 336

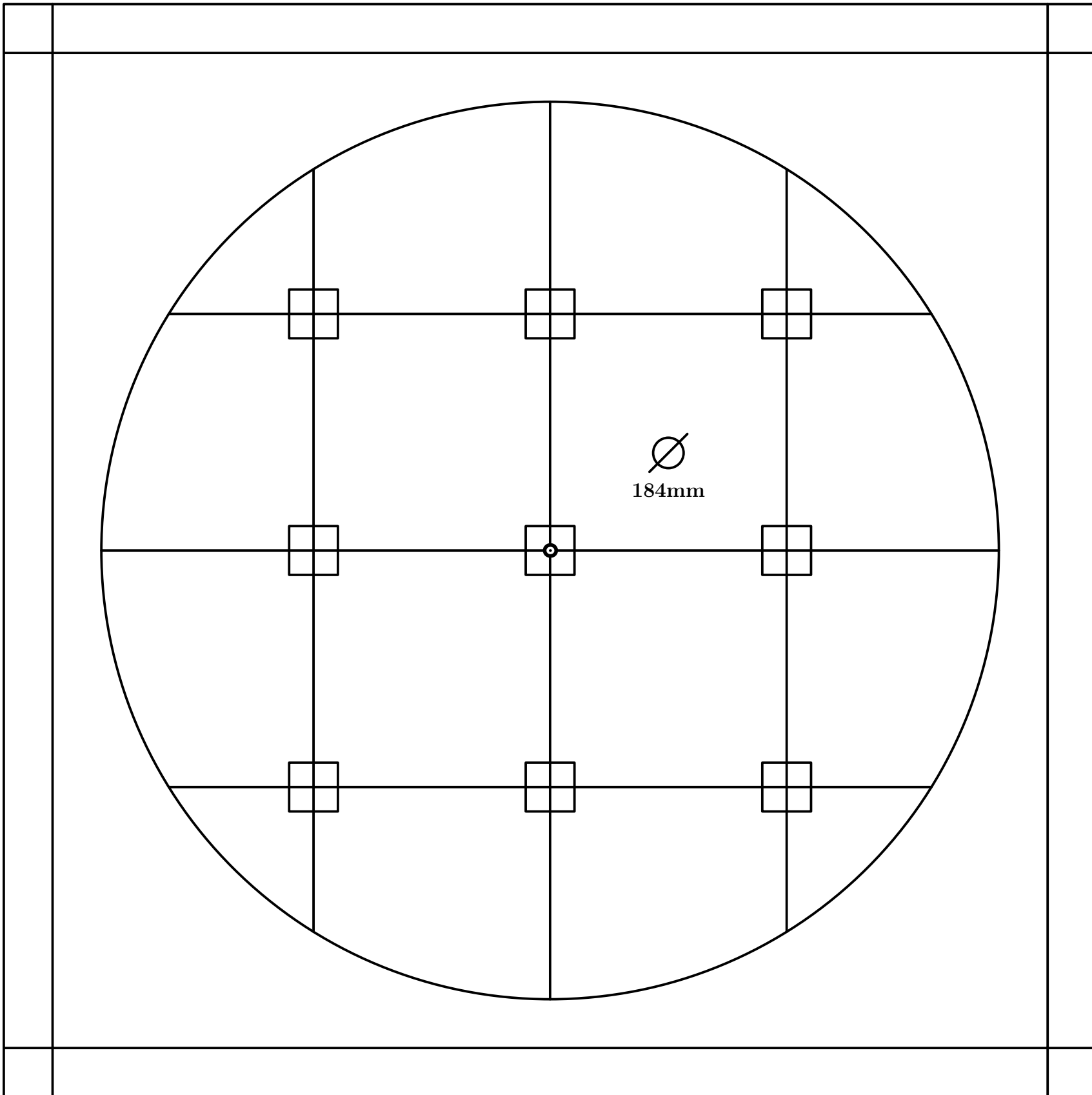

Fig. 337

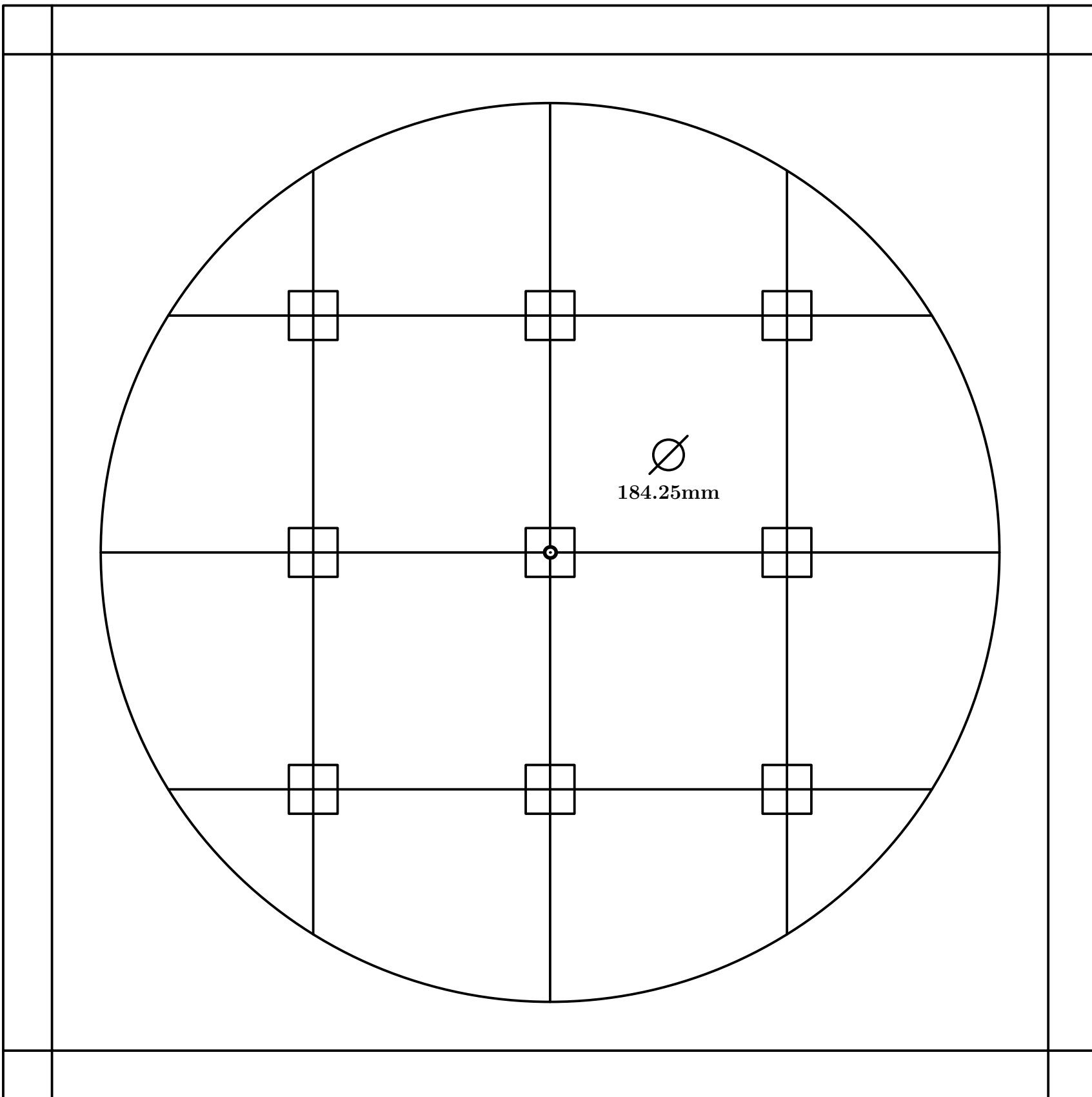

Fig. 338

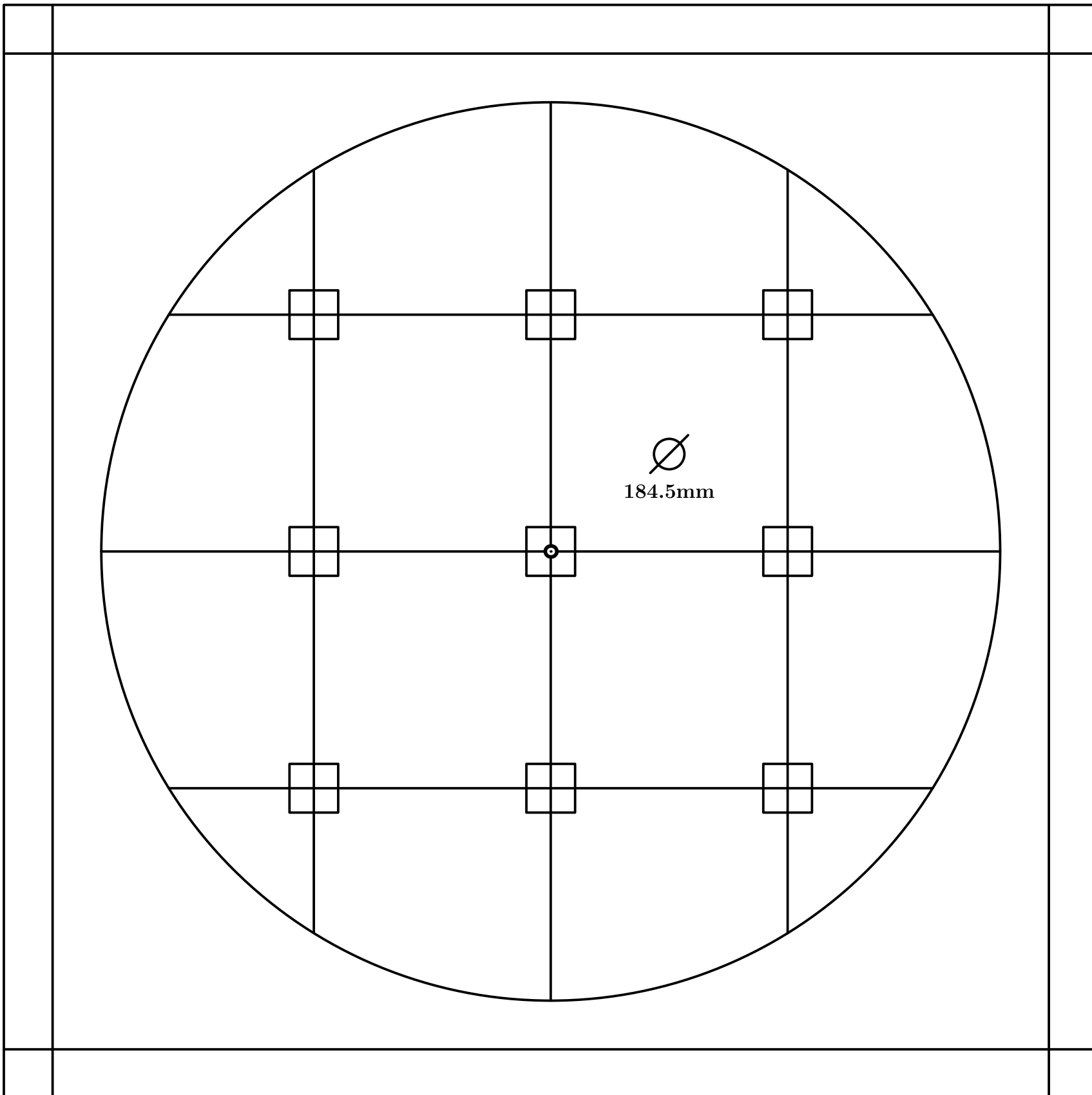

Fig. 339

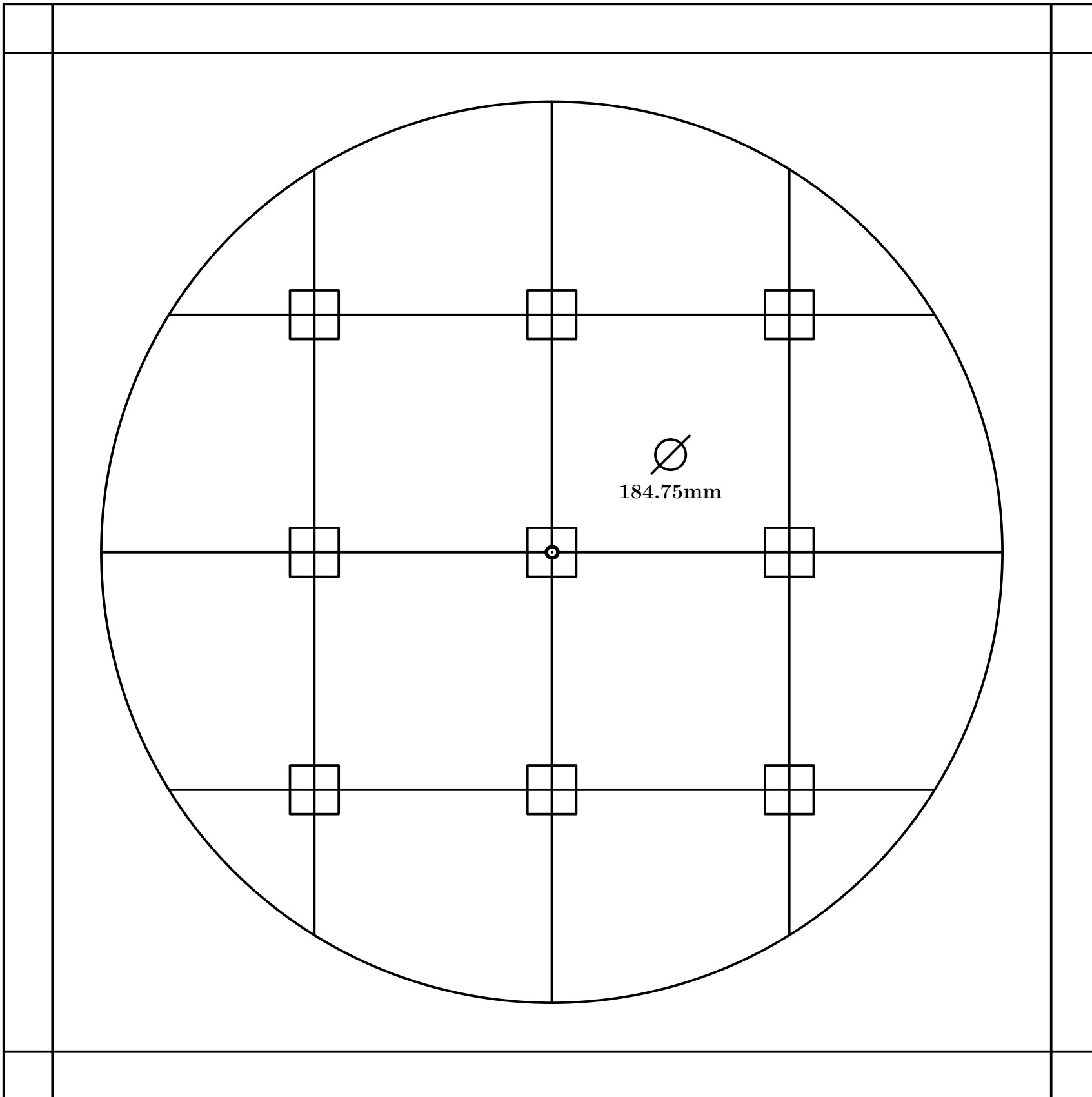

Fig. 340

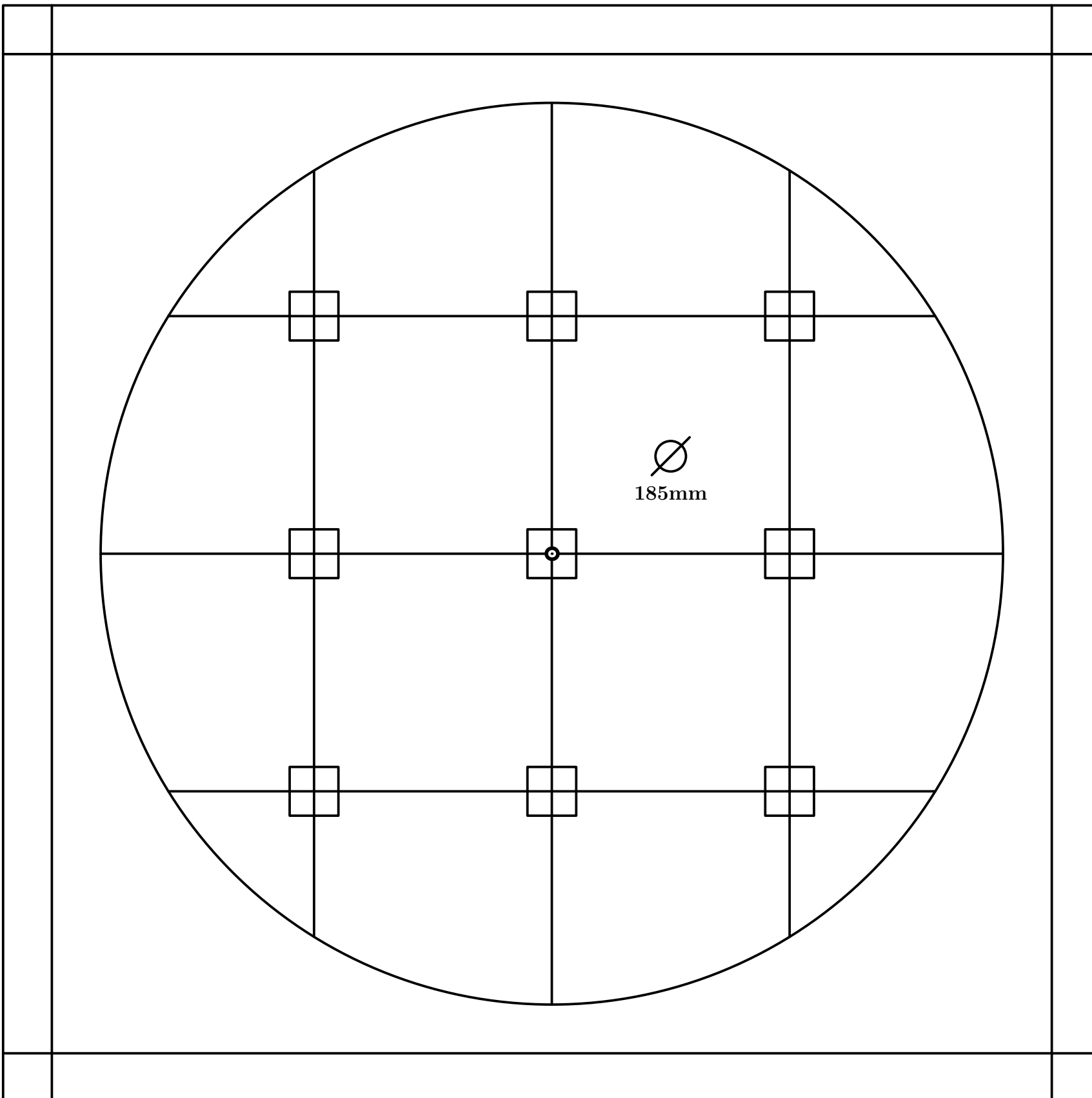

Fig. 341

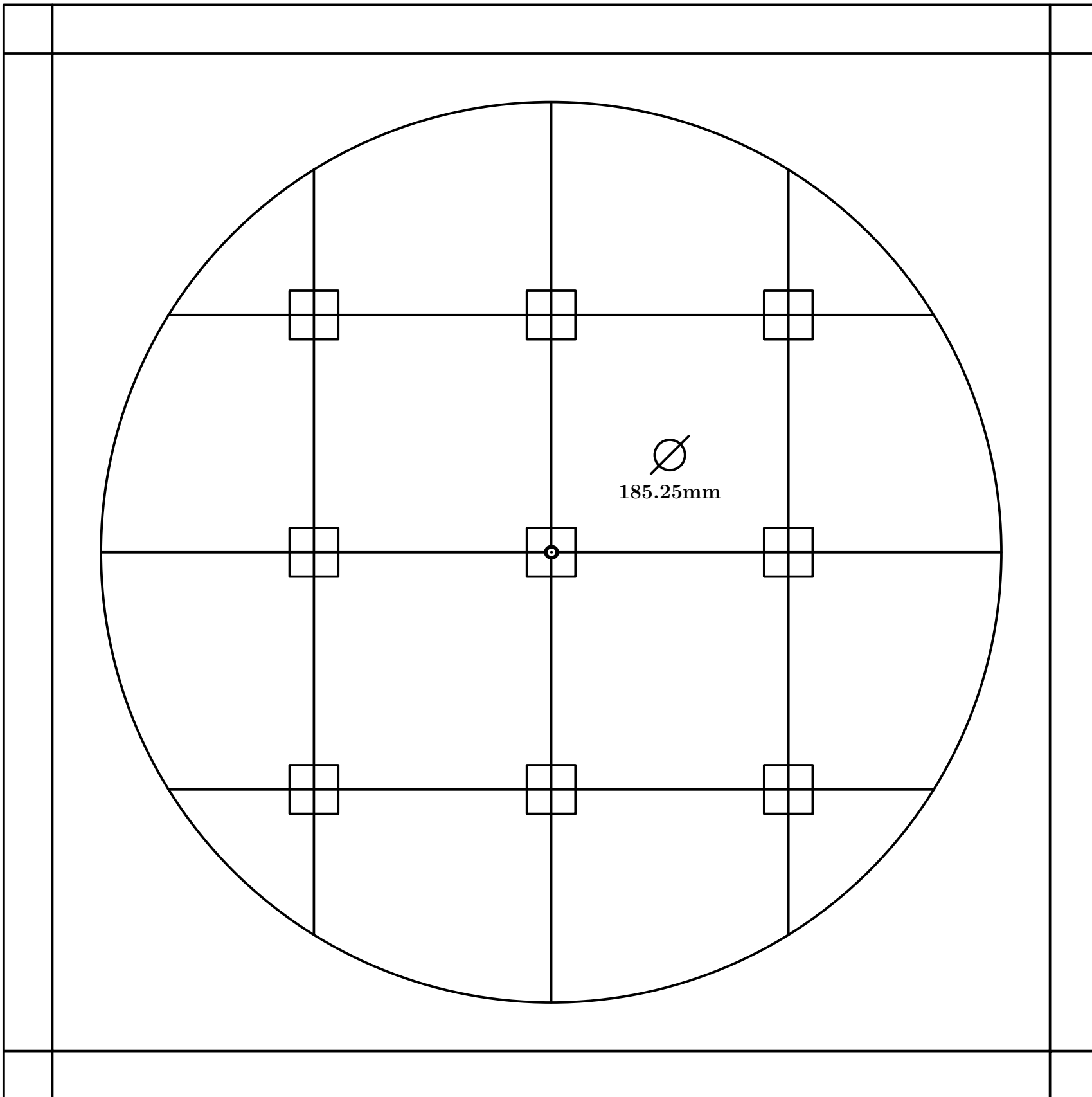

Fig. 342

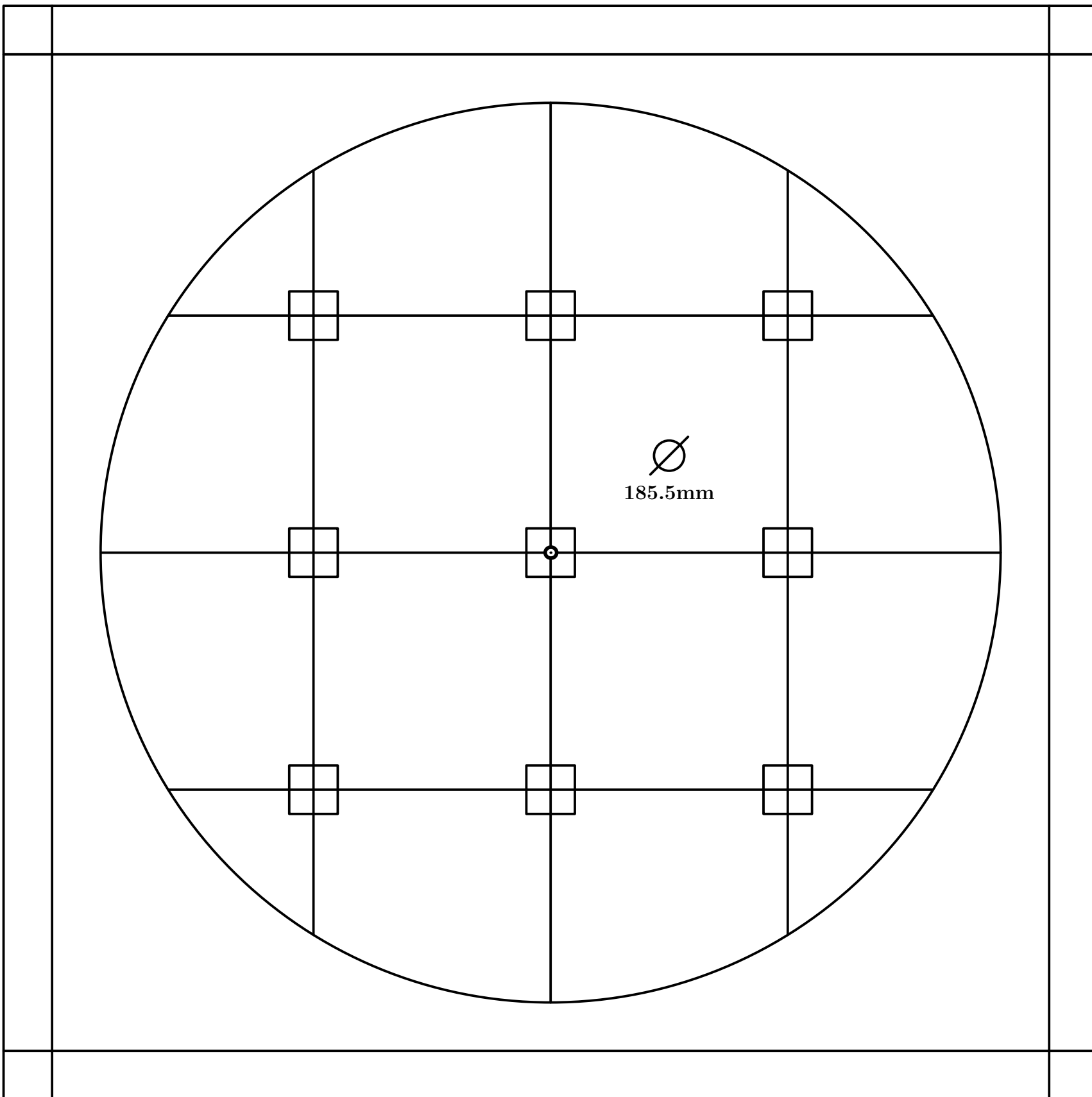

Fig. 343

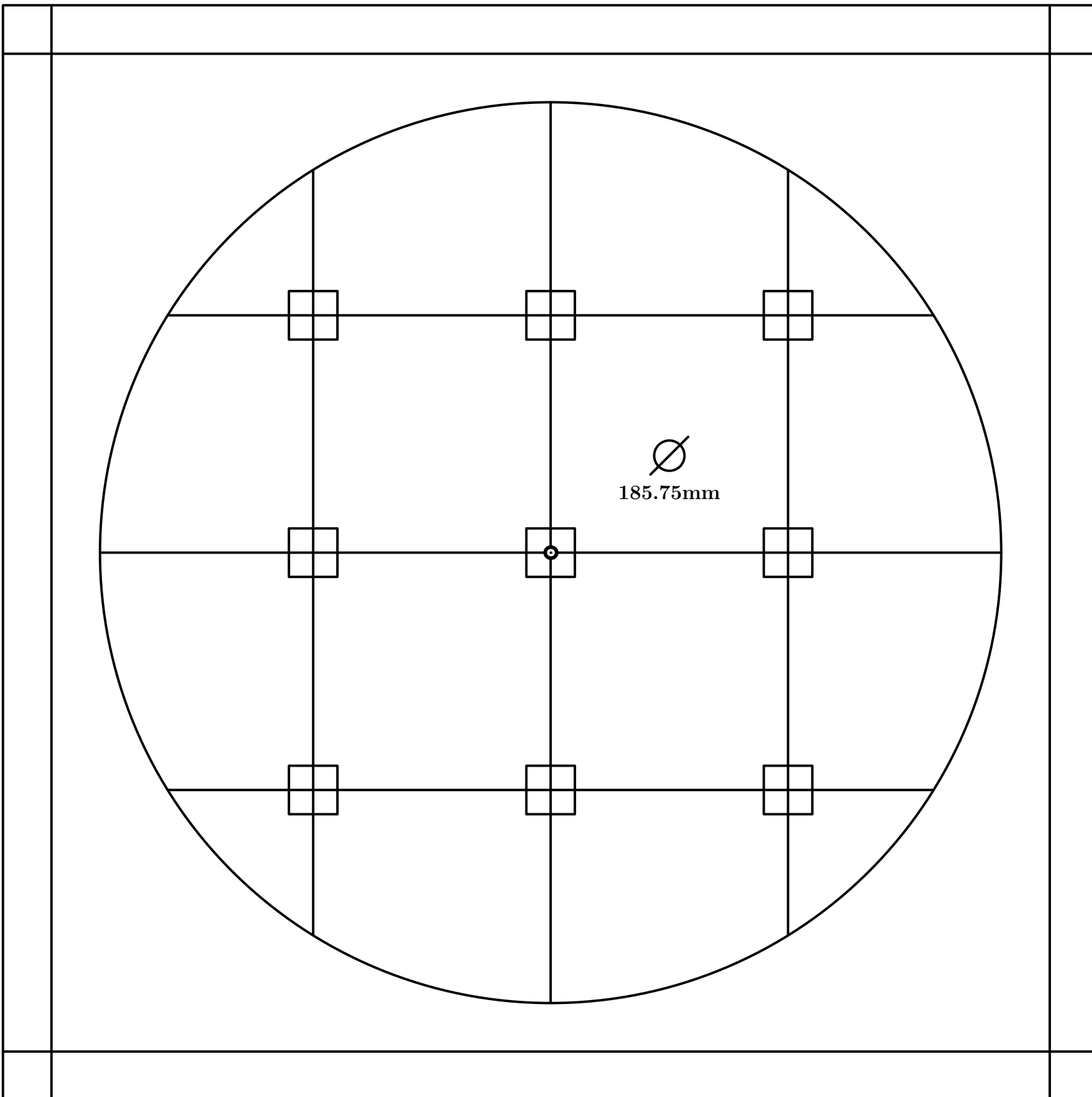

Fig. 344

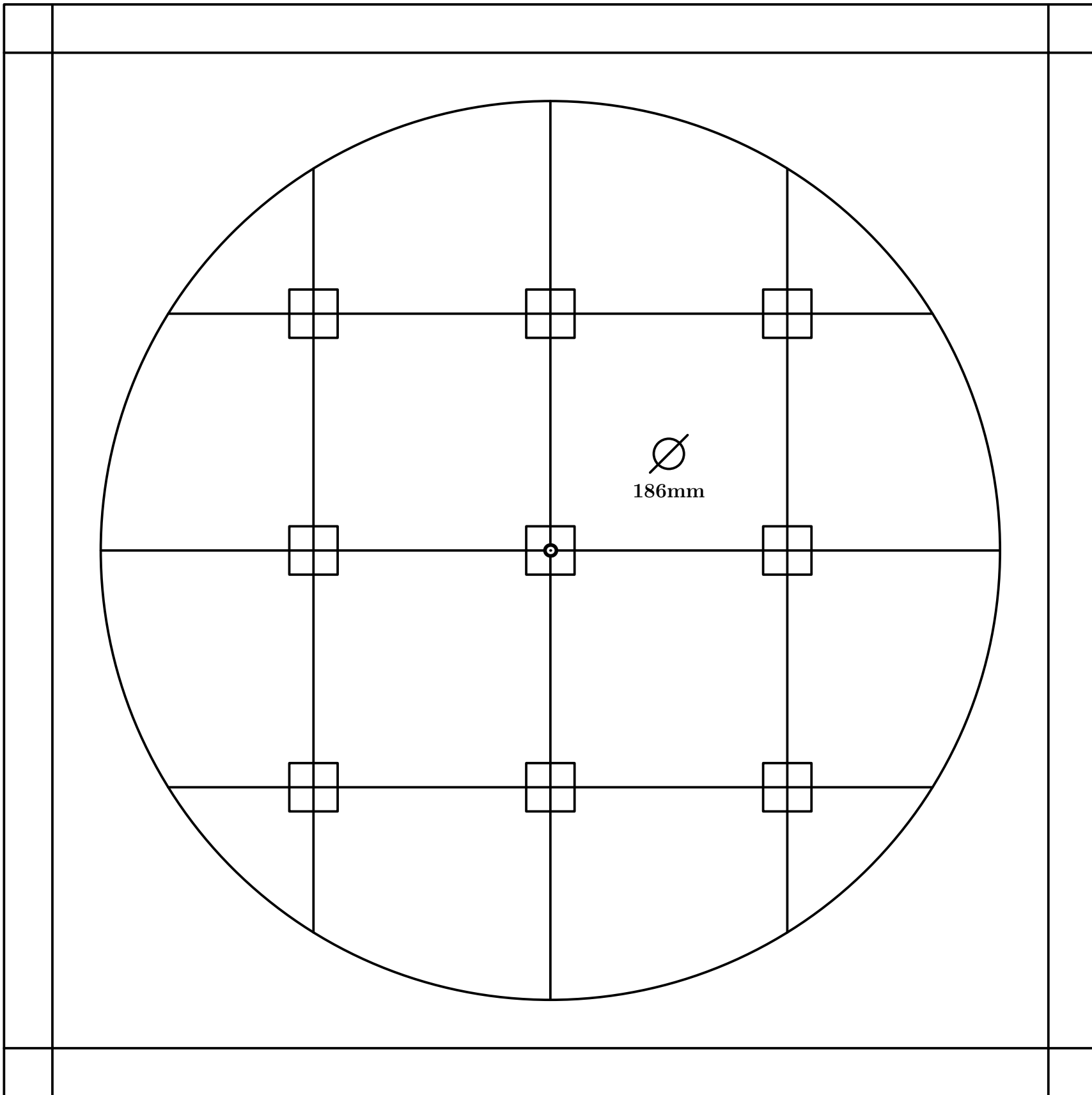

Fig. 345

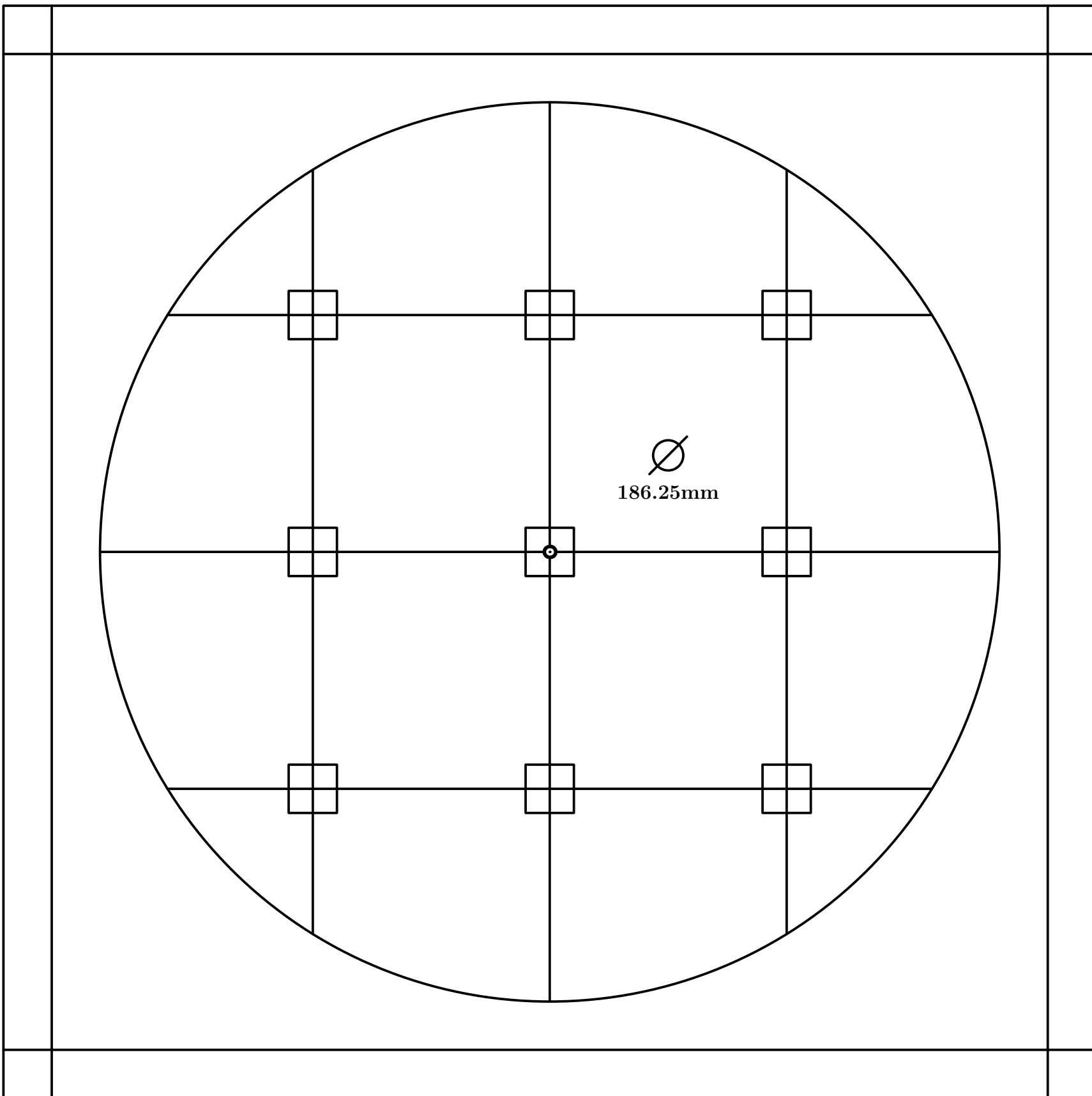

Fig. 346

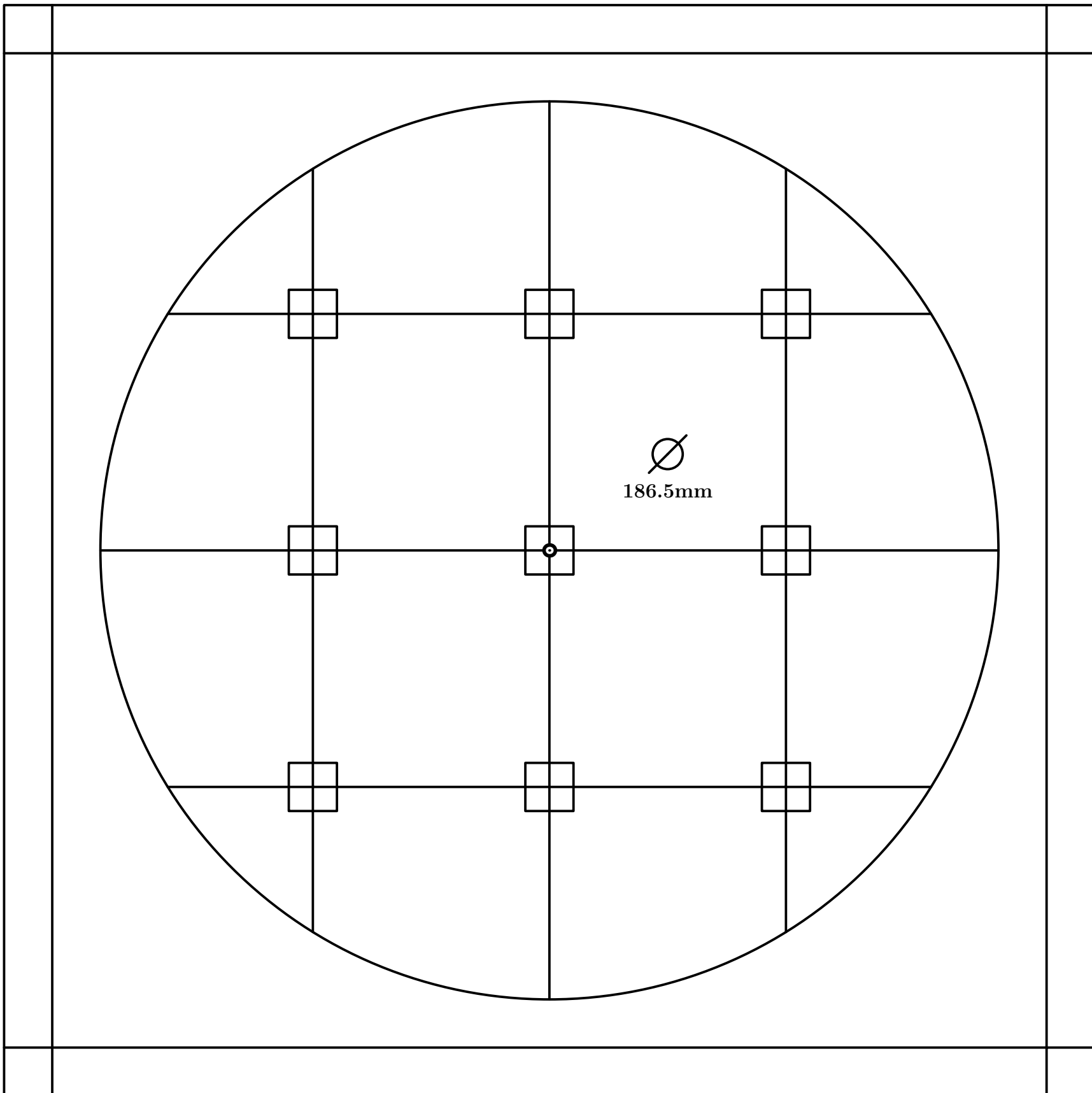

Fig. 347

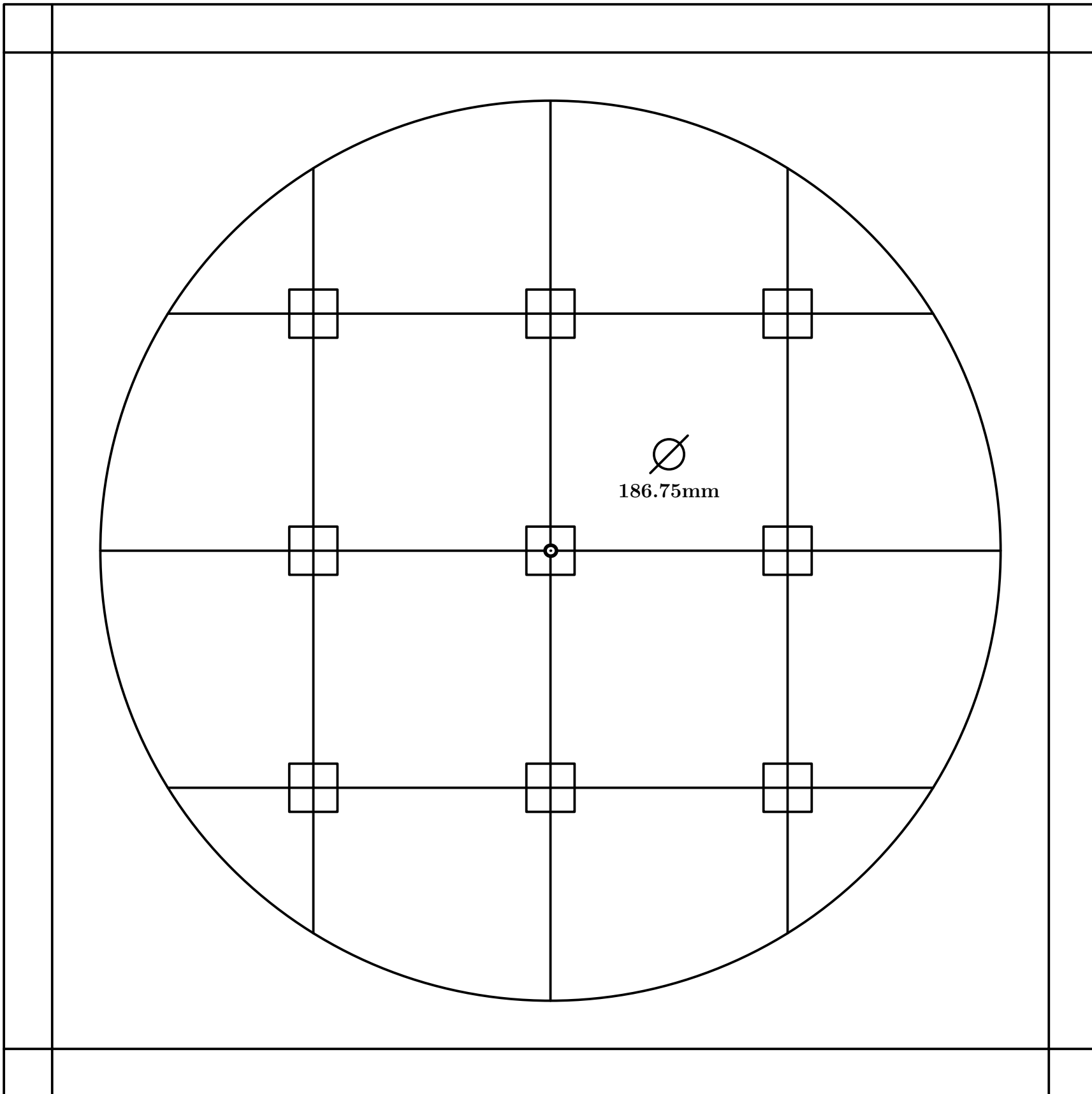

Fig. 348

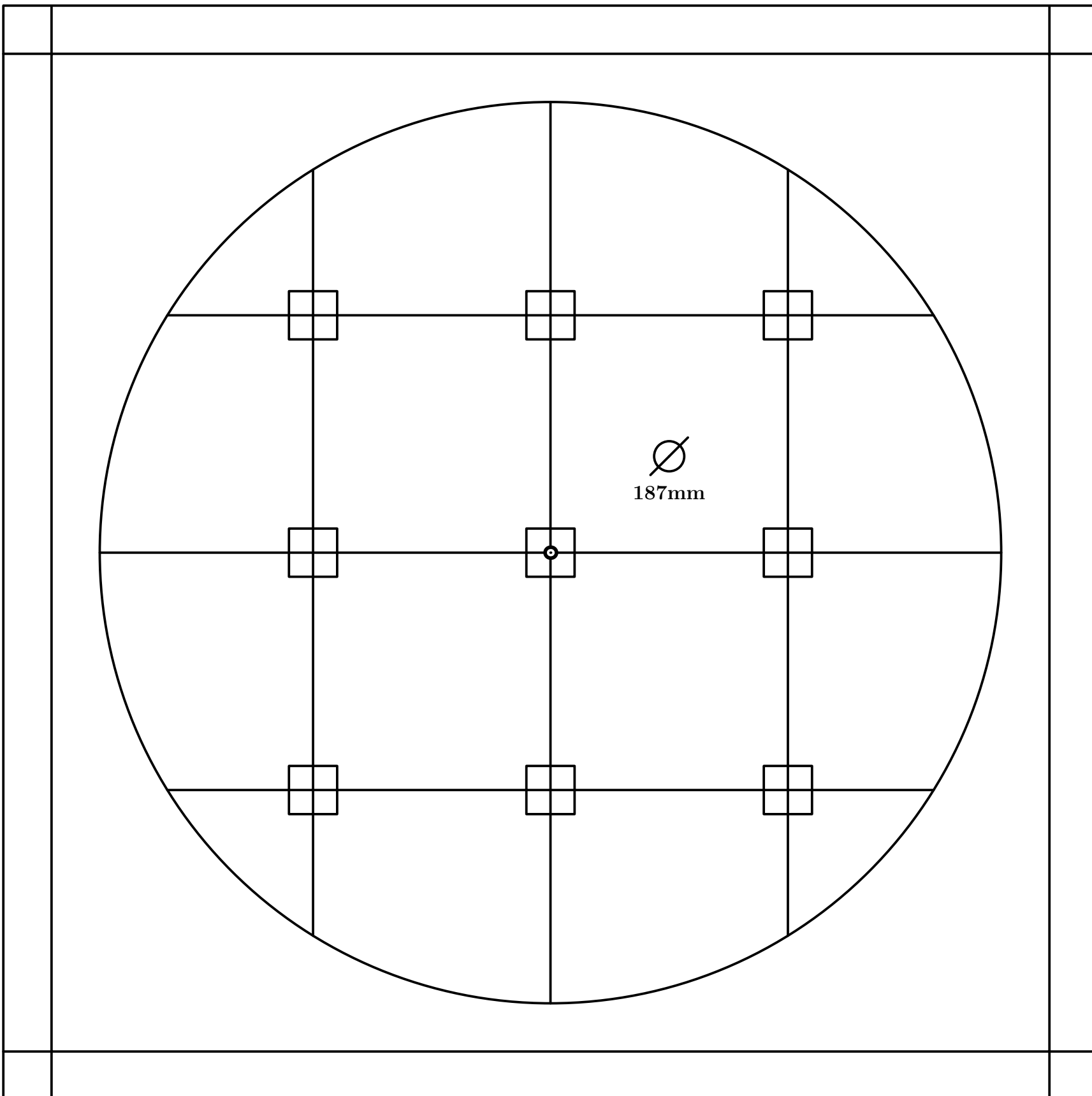

Fig. 349

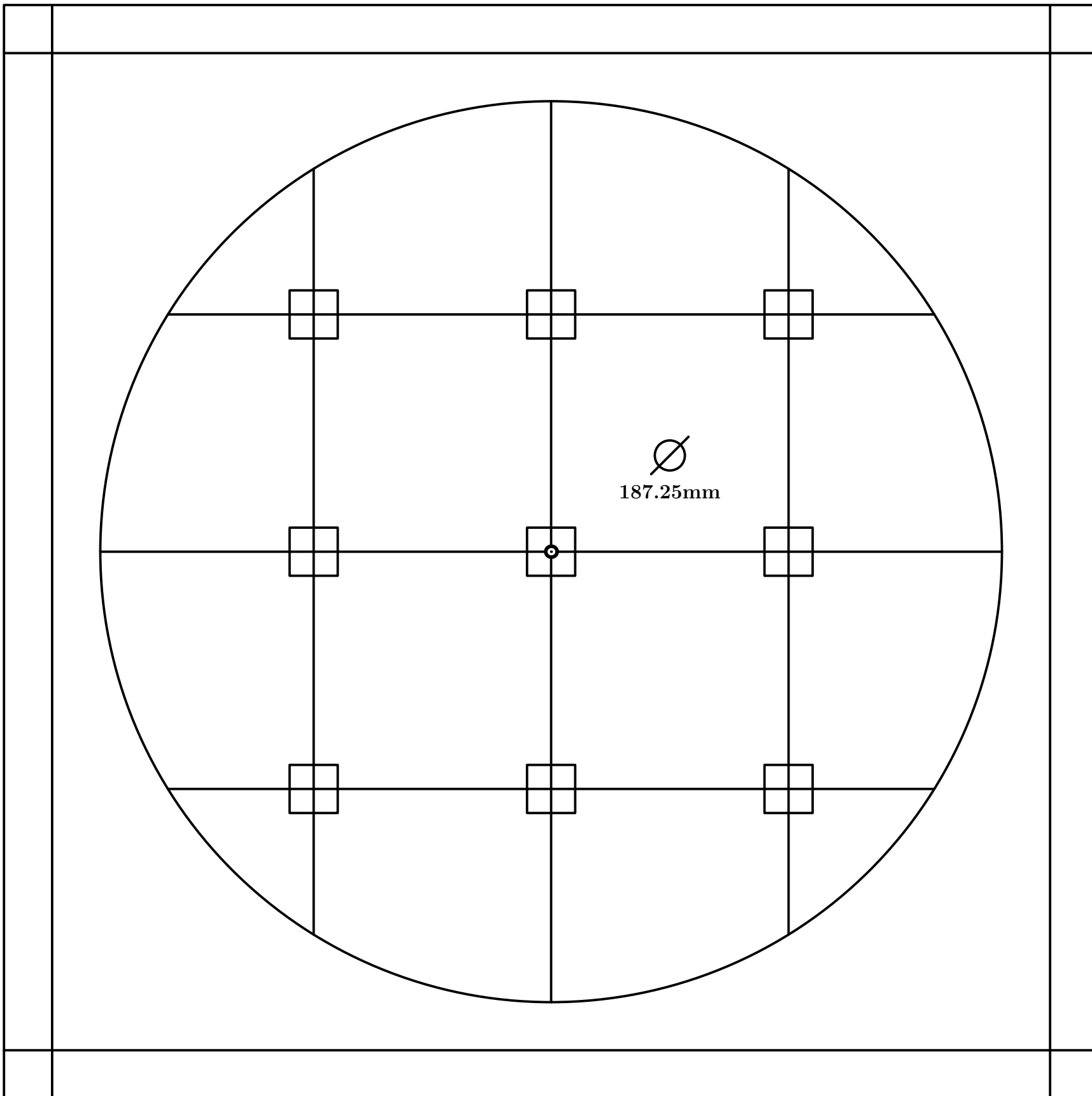

Fig. 350

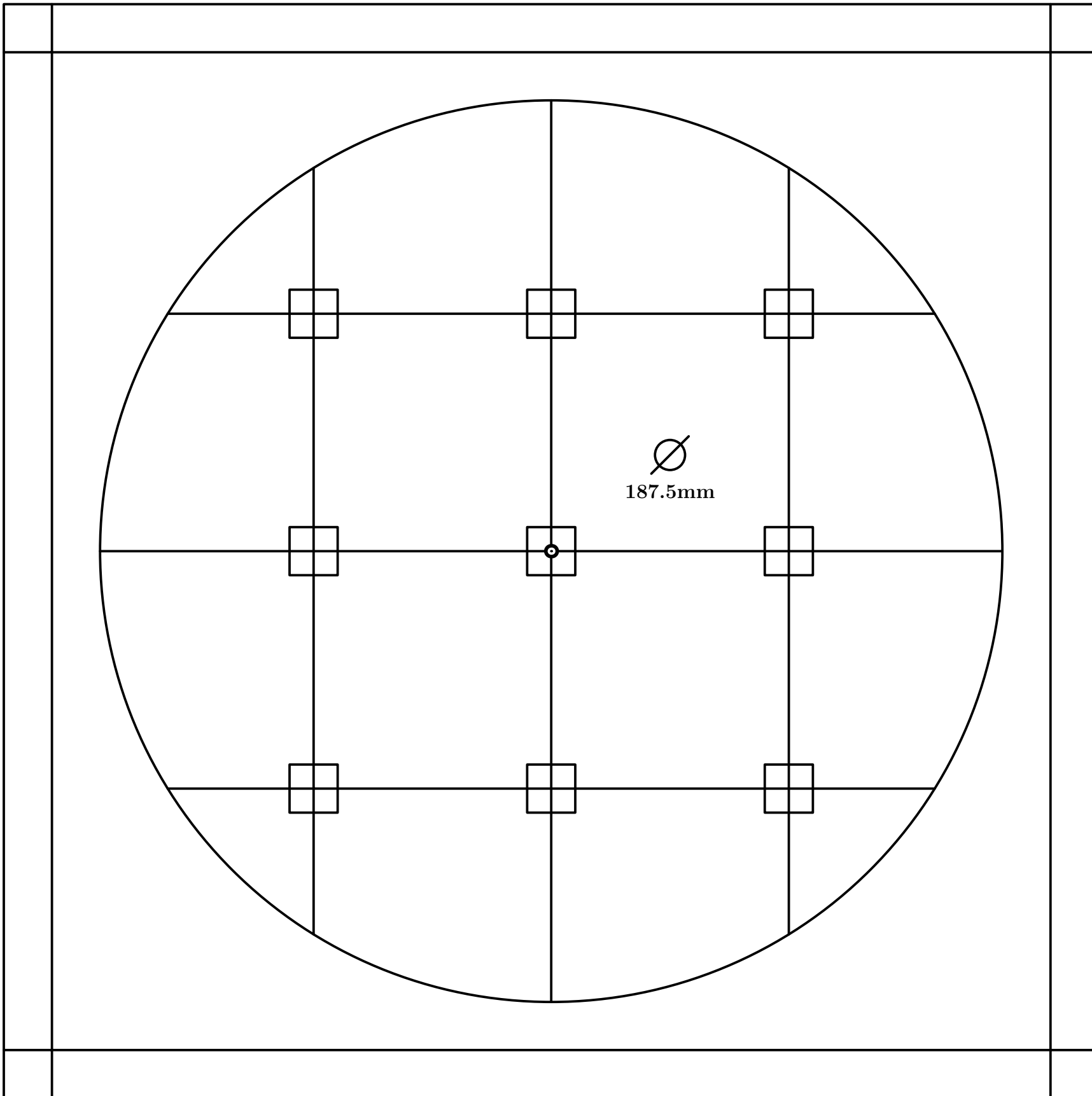

Fig. 351

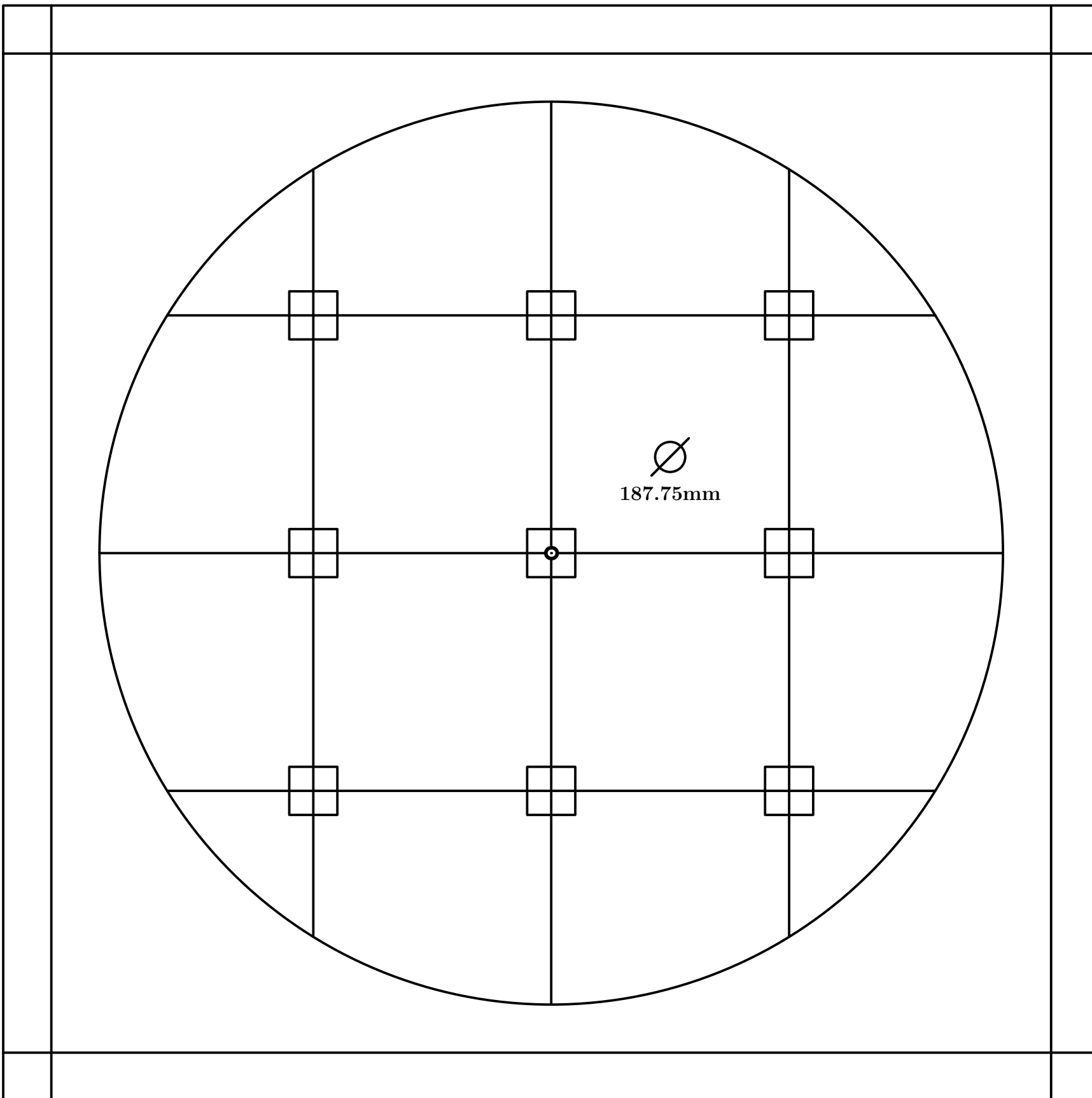

Fig. 352

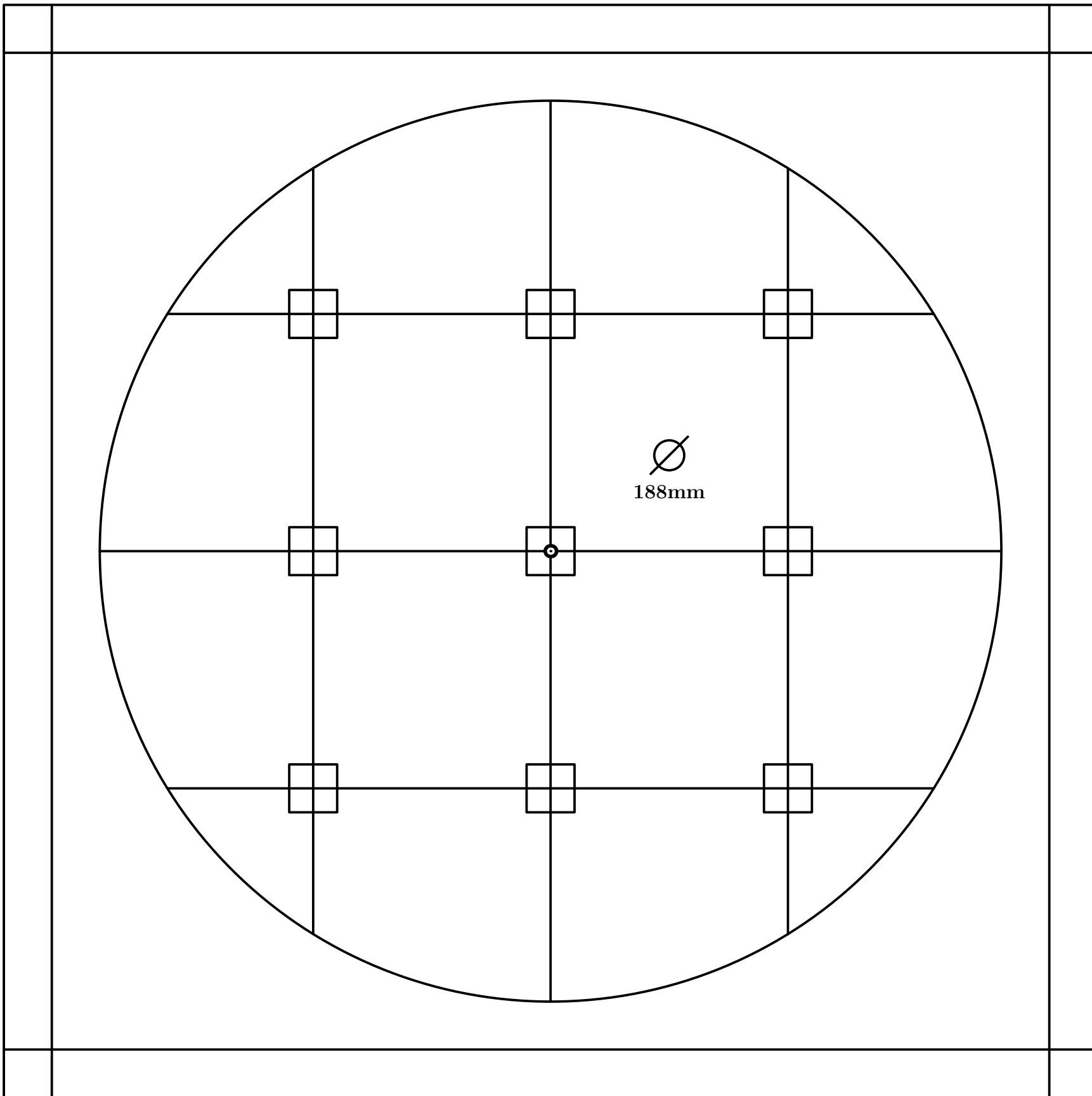

Fig. 353

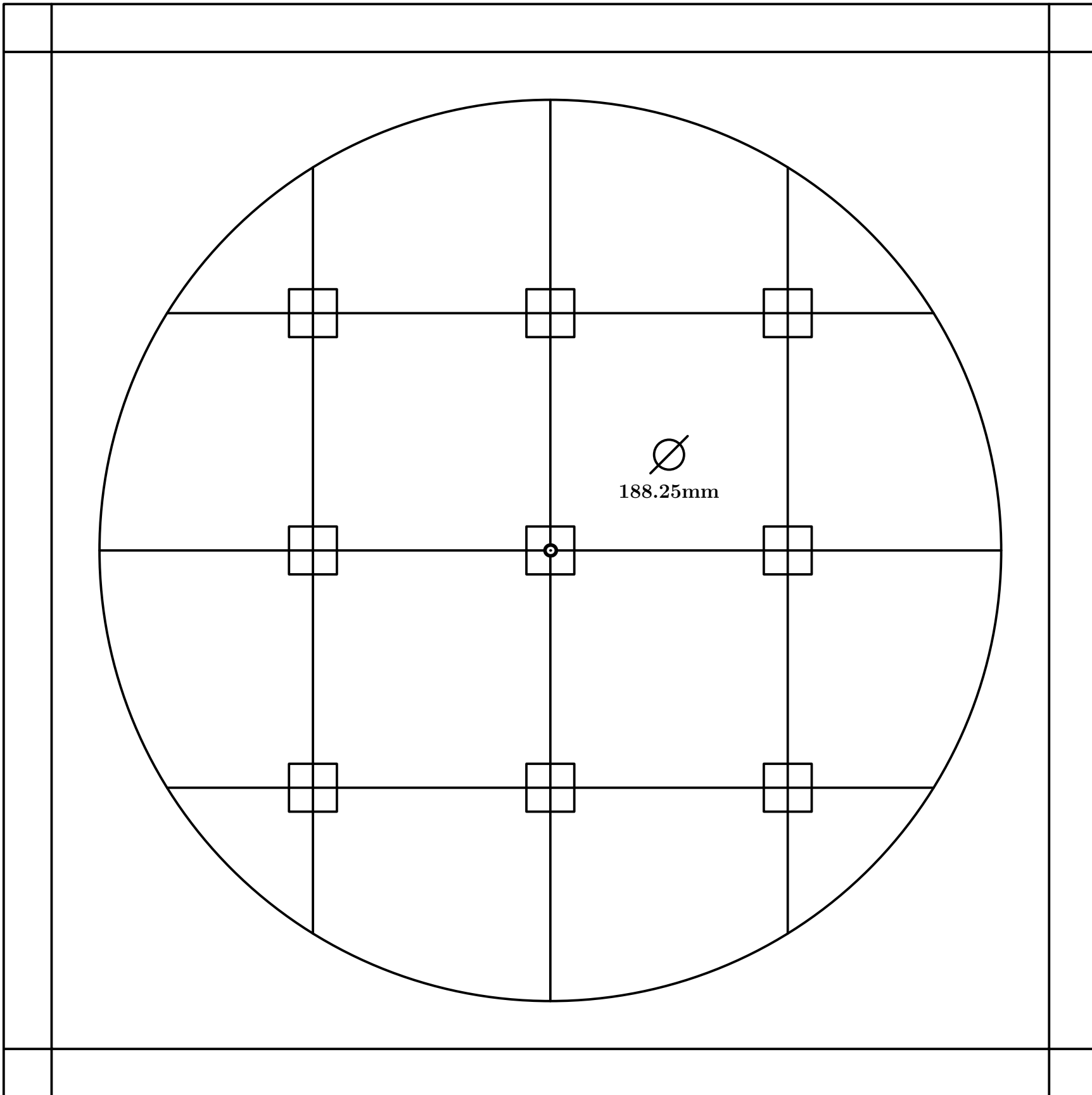

Fig. 354

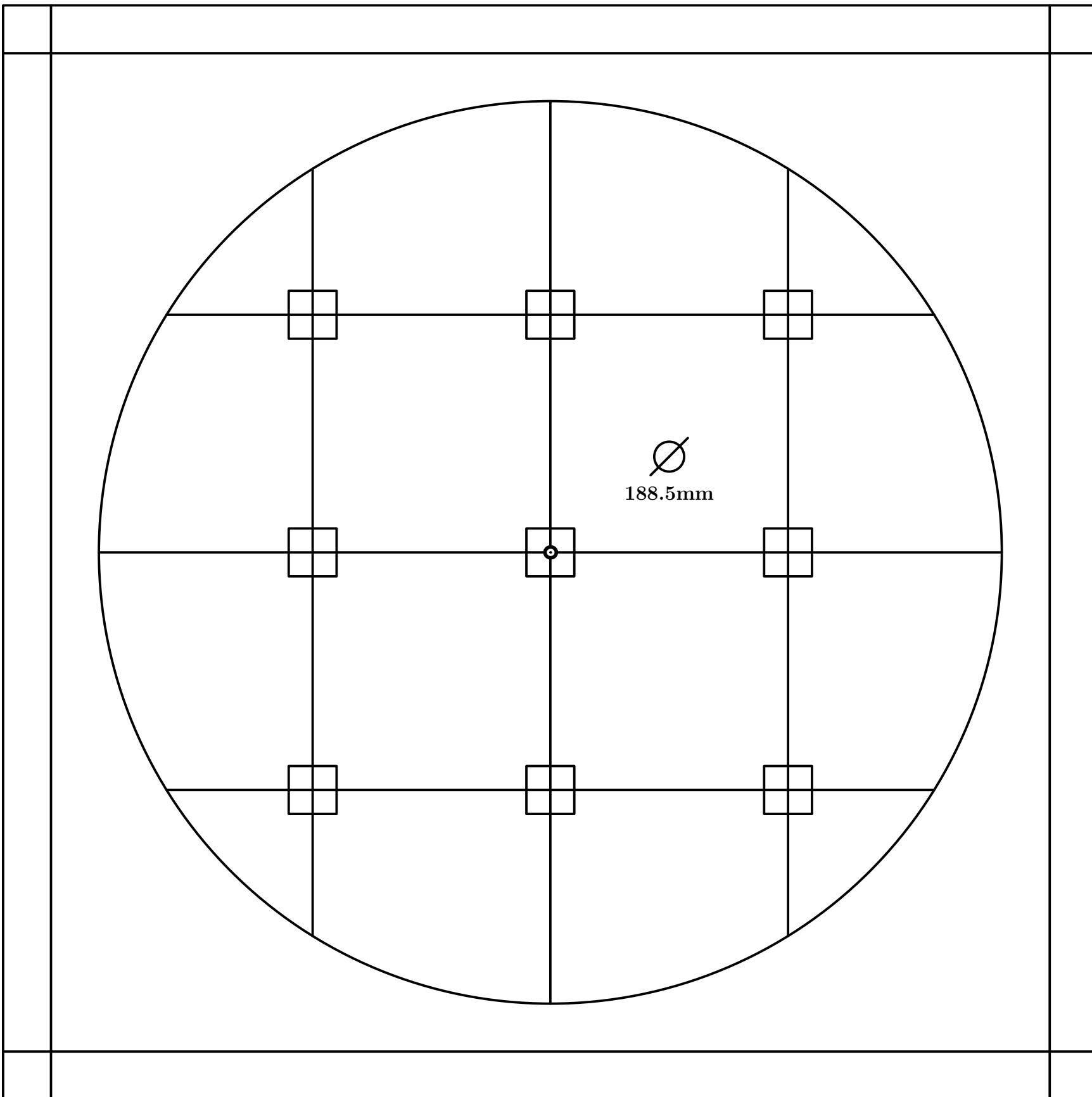

Fig. 355

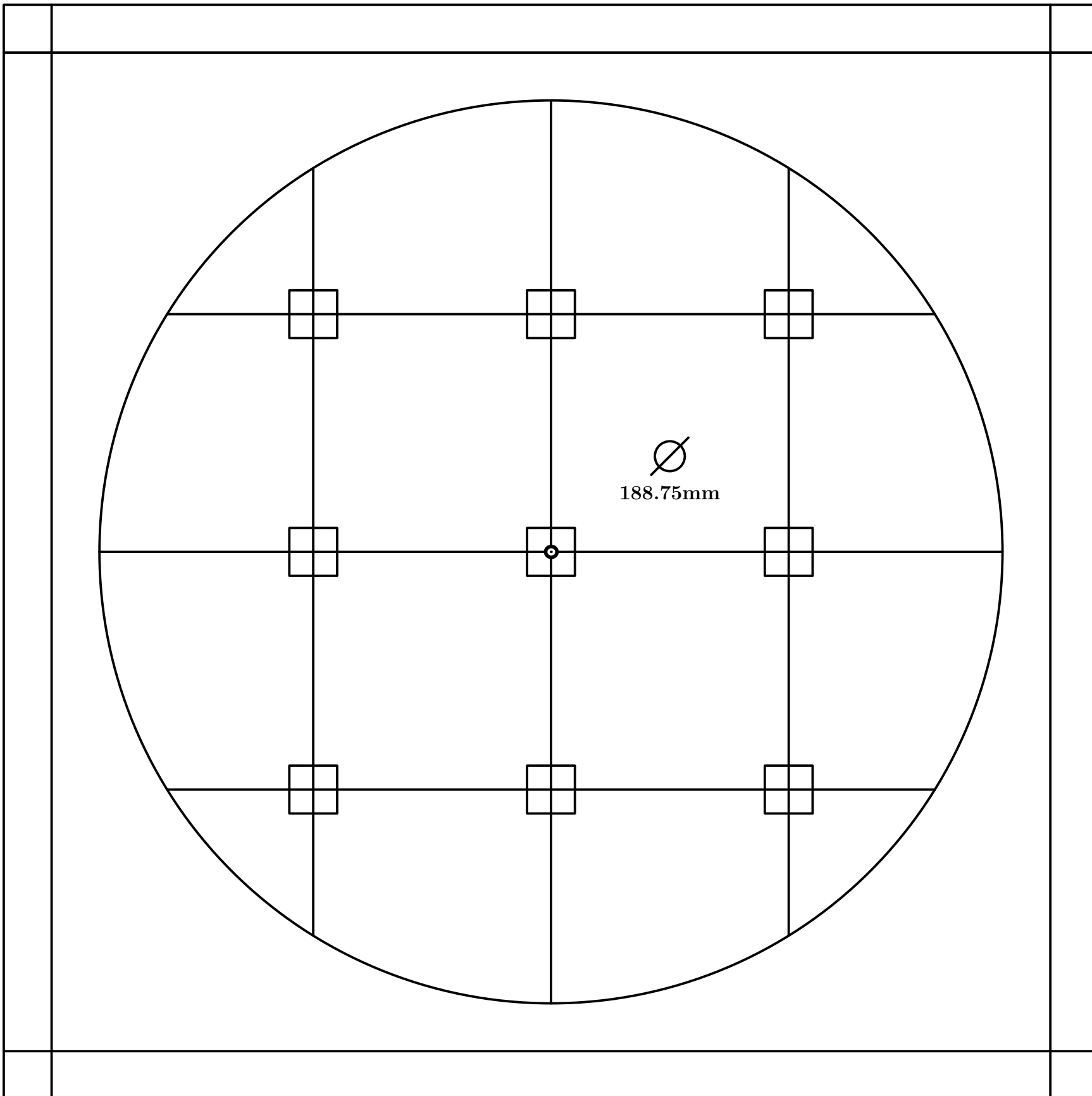

Fig. 356

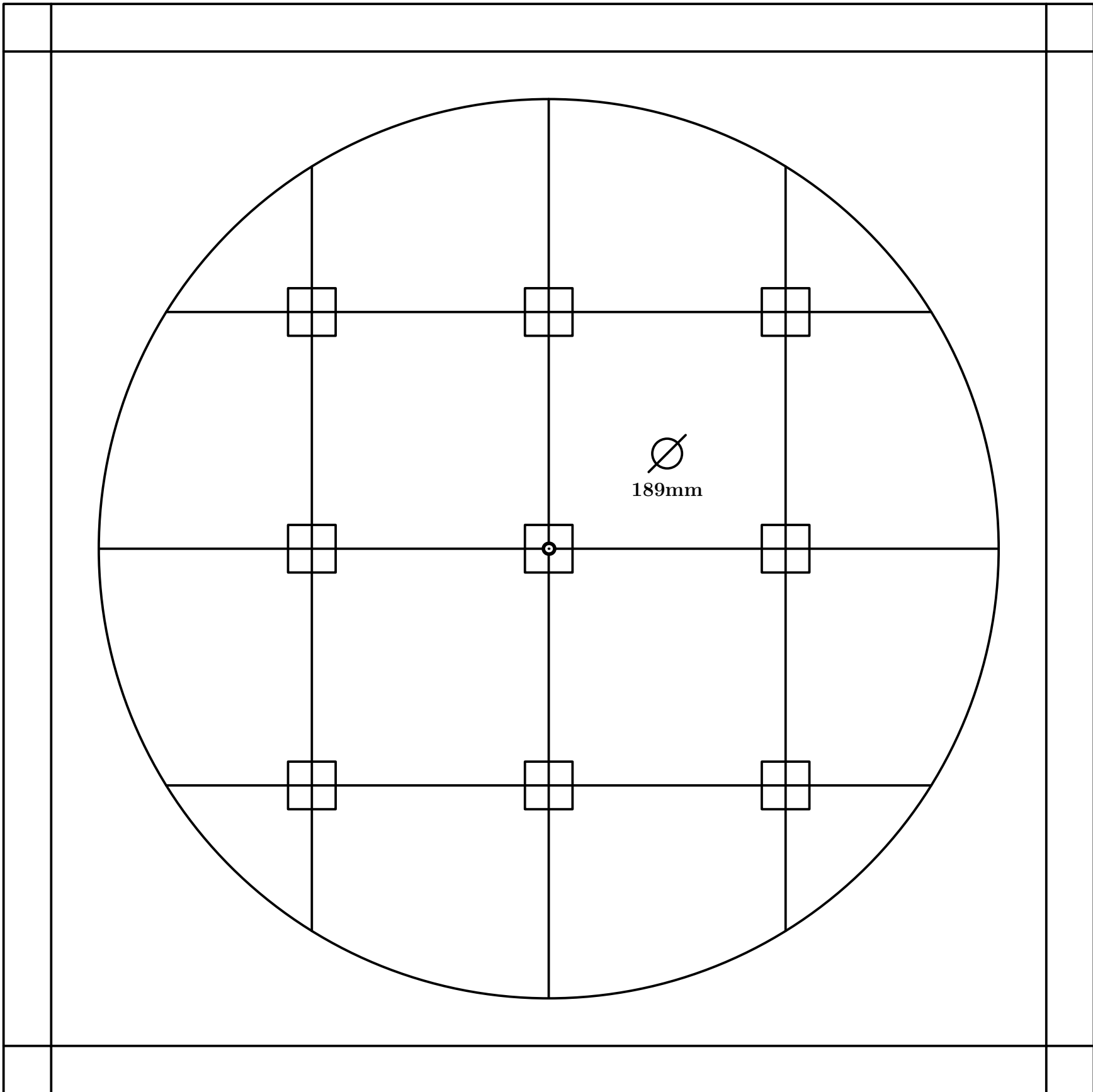

Fig. 357

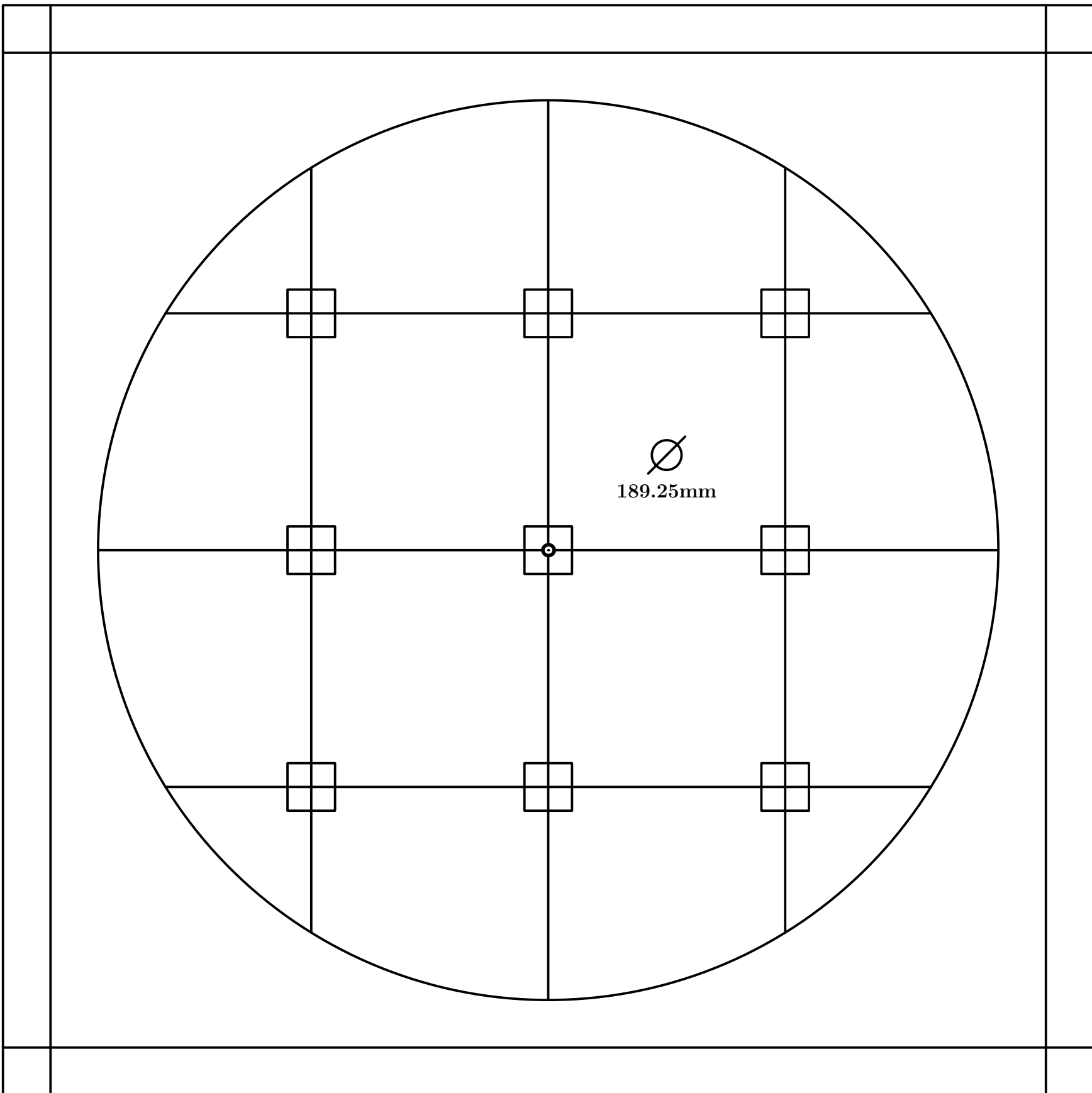

Fig. 358

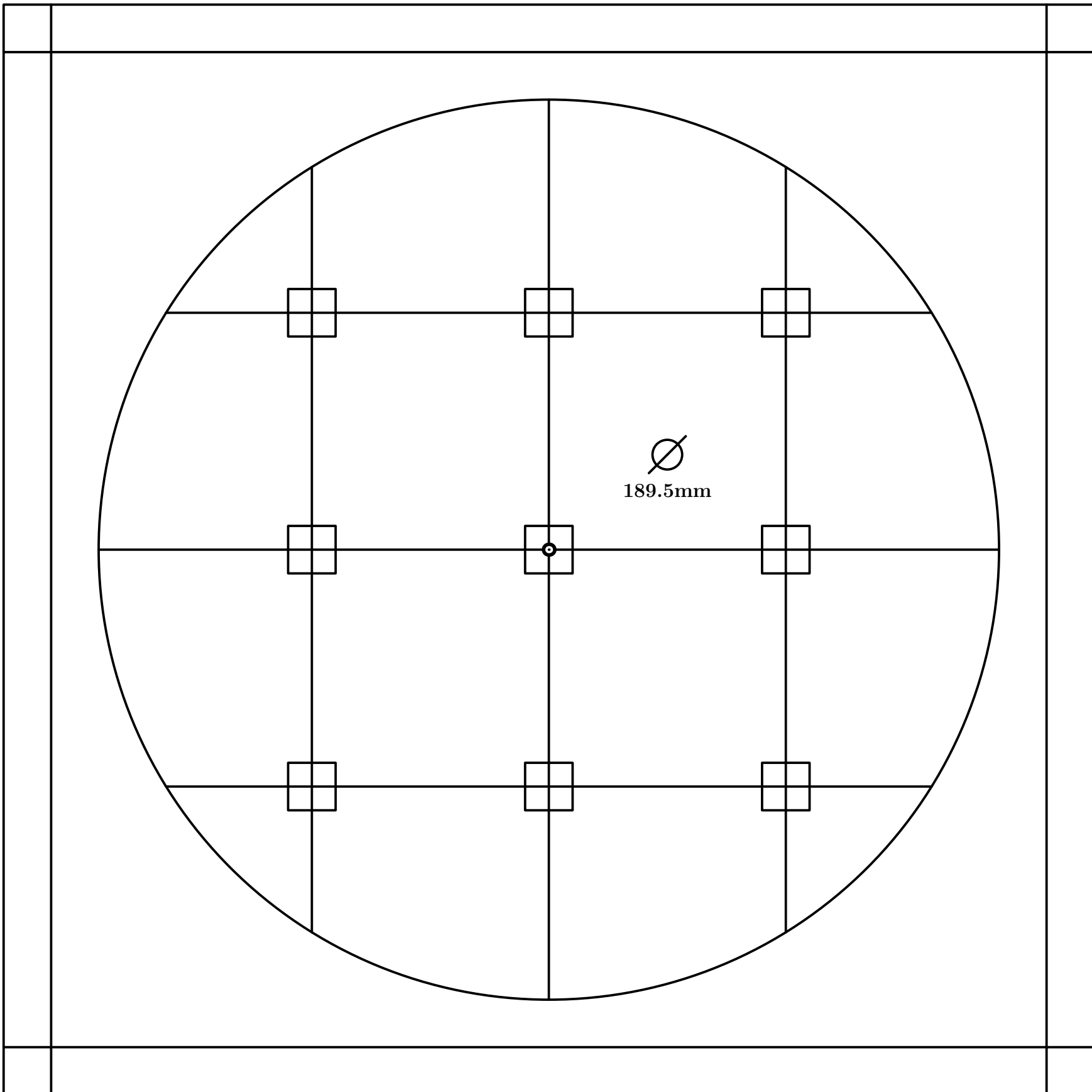

Fig. 359

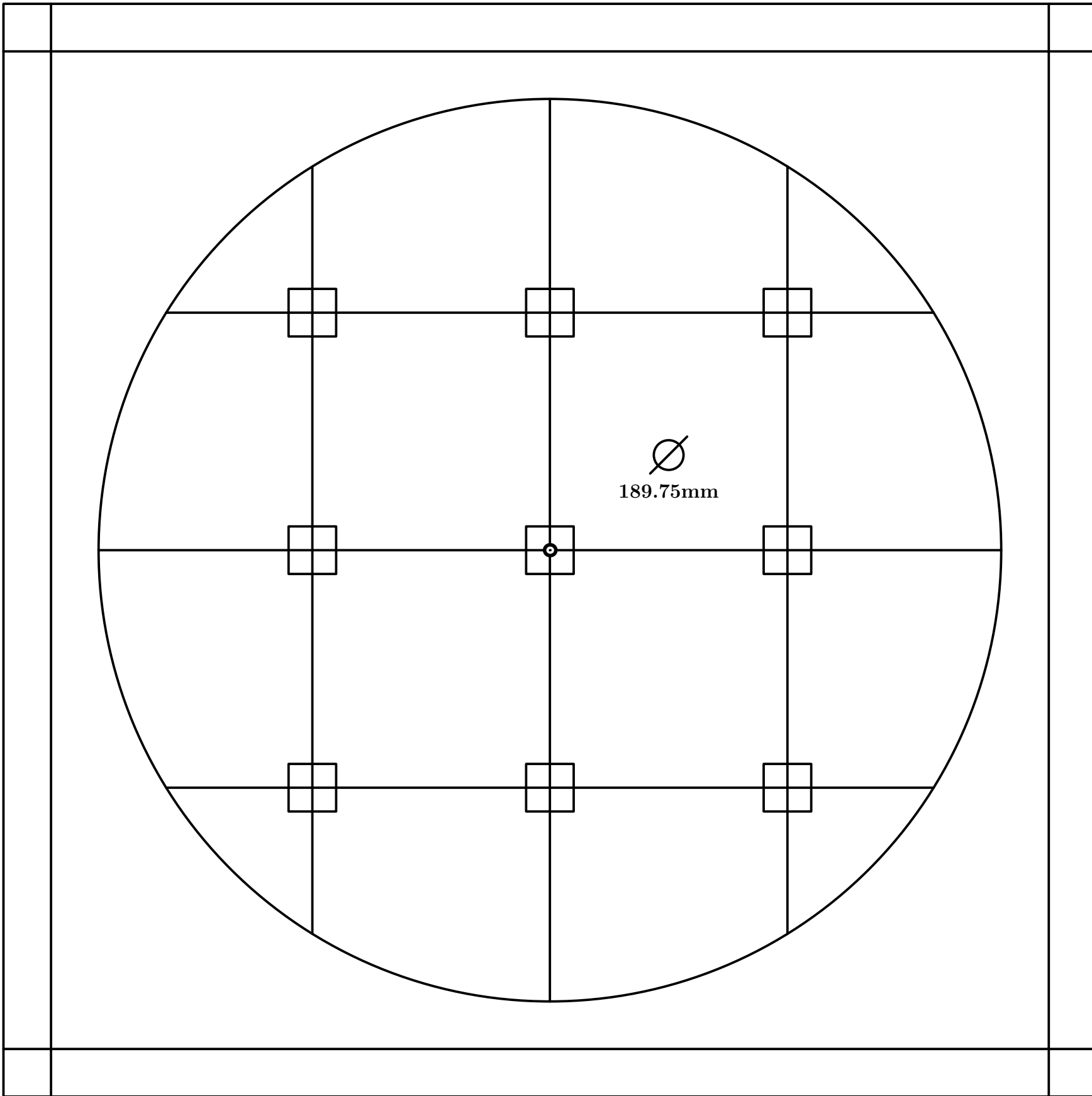

Fig. 360

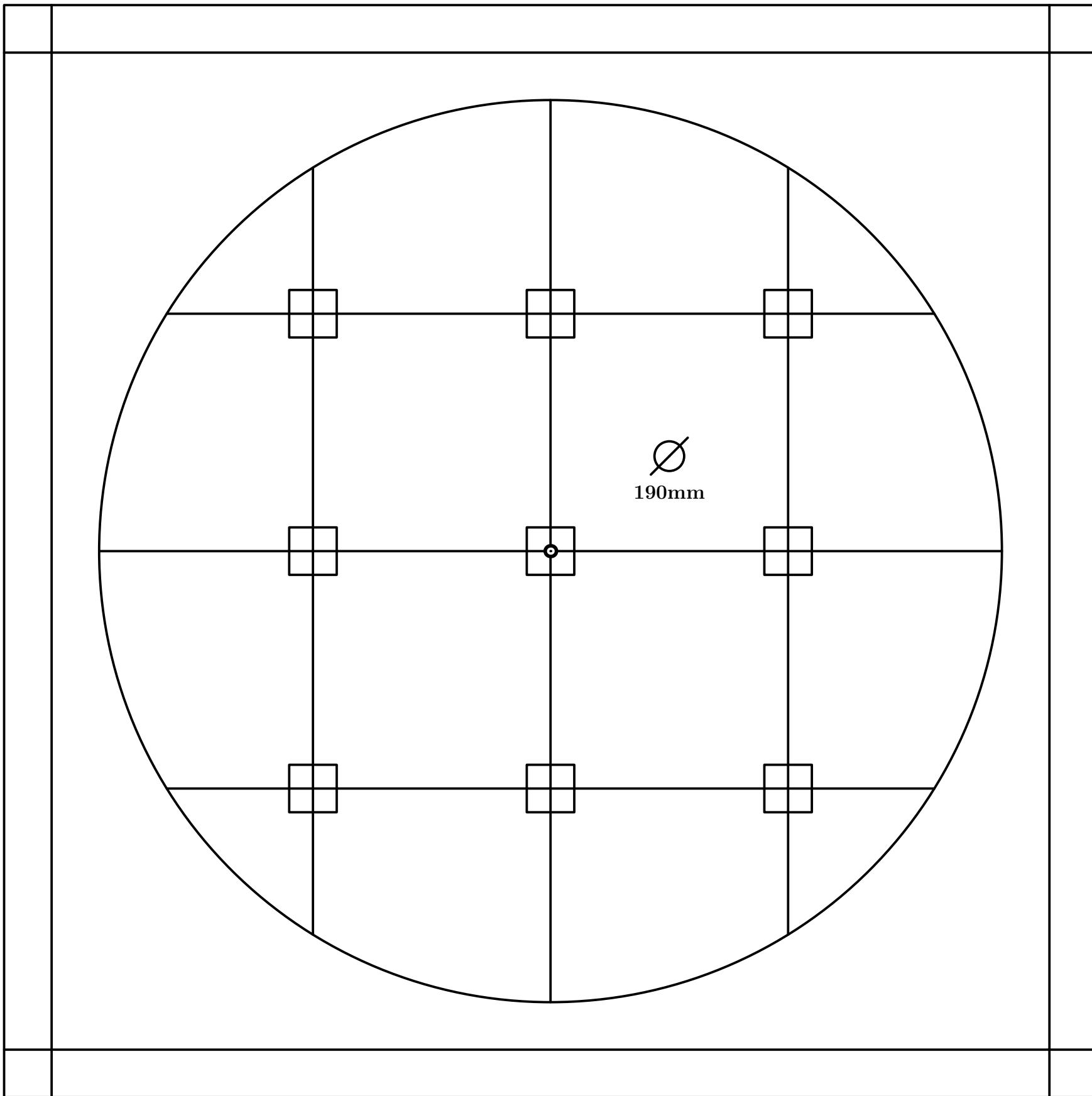

Fig. 361

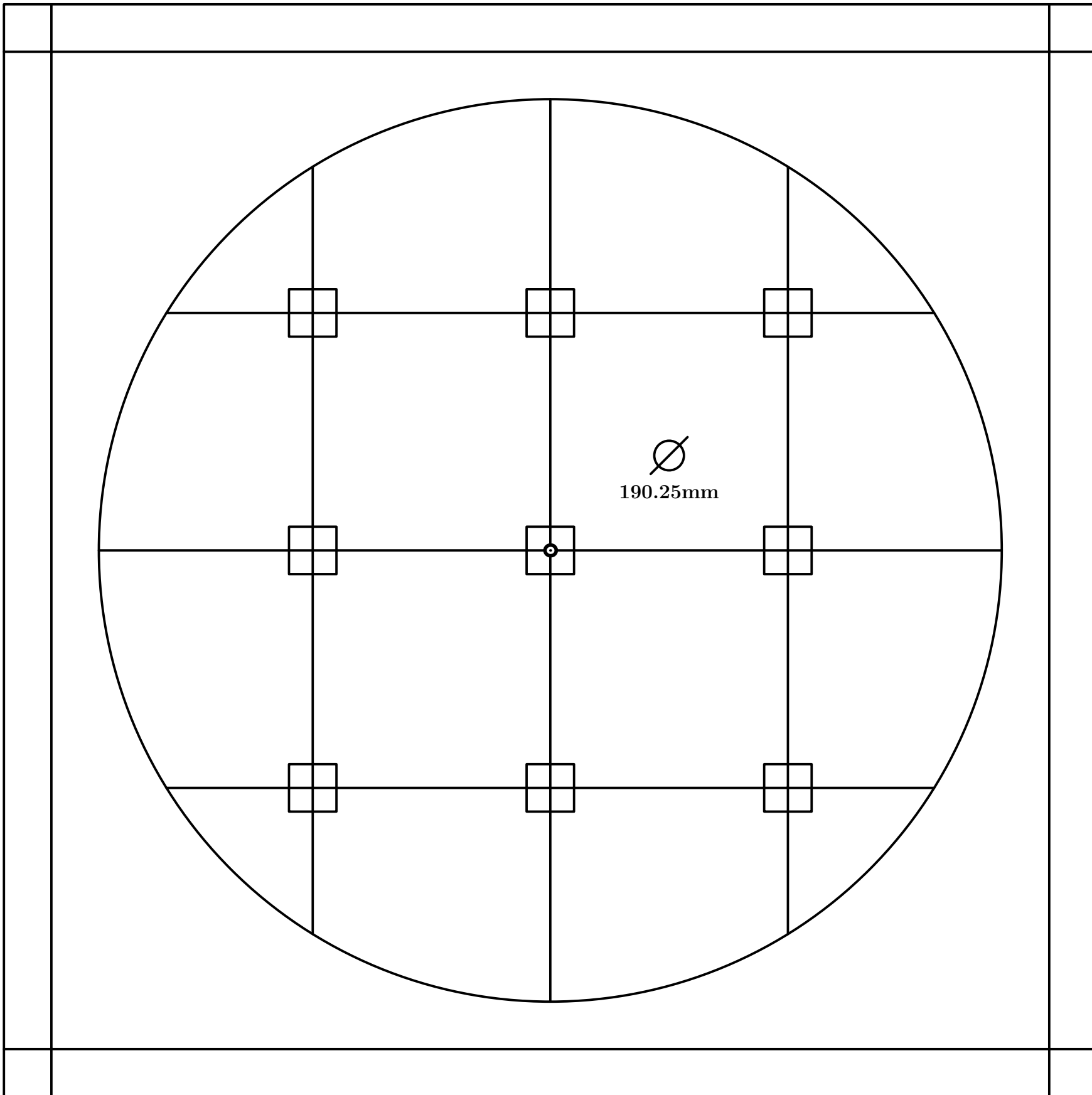

Fig. 362

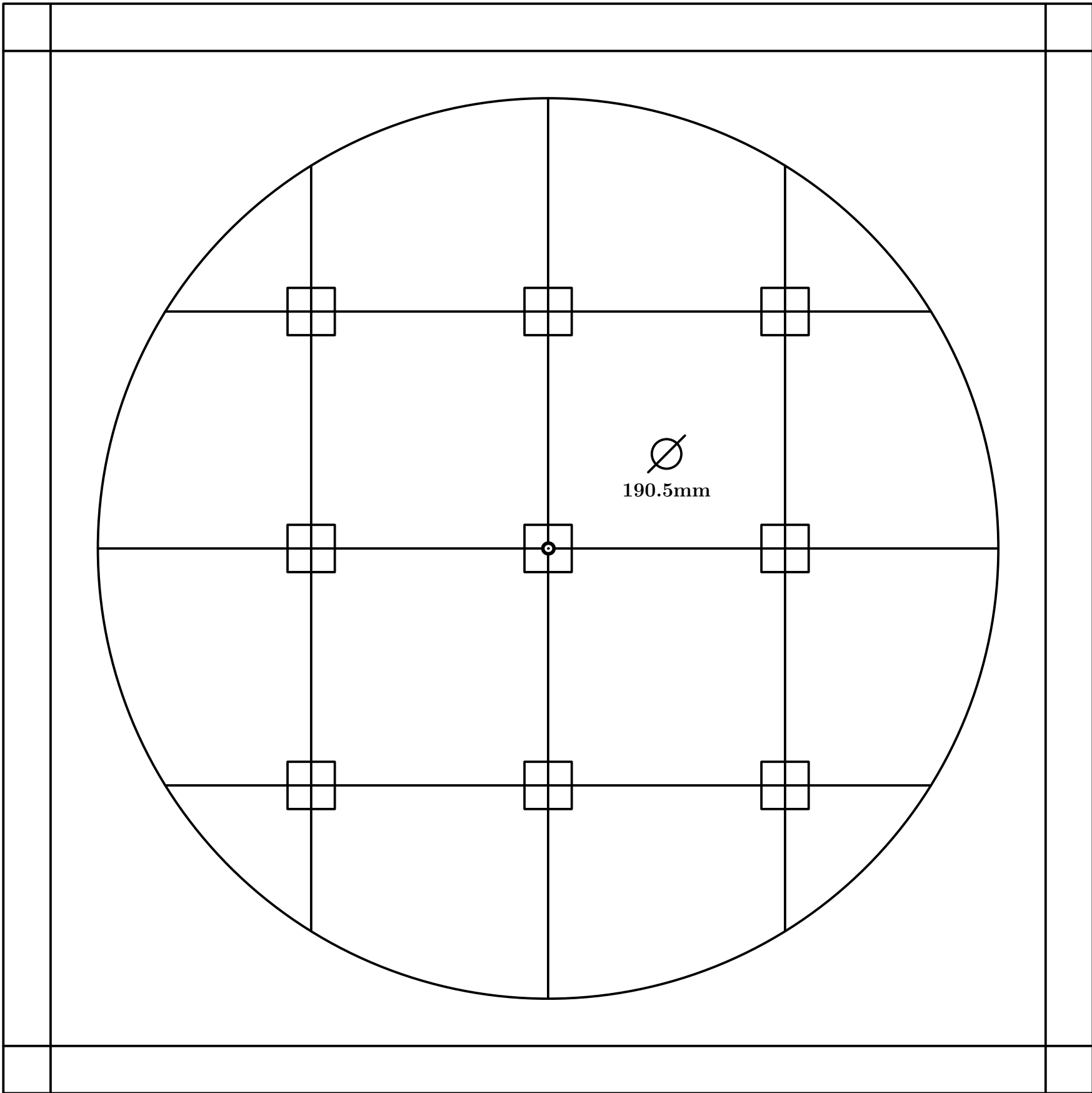

Fig. 363

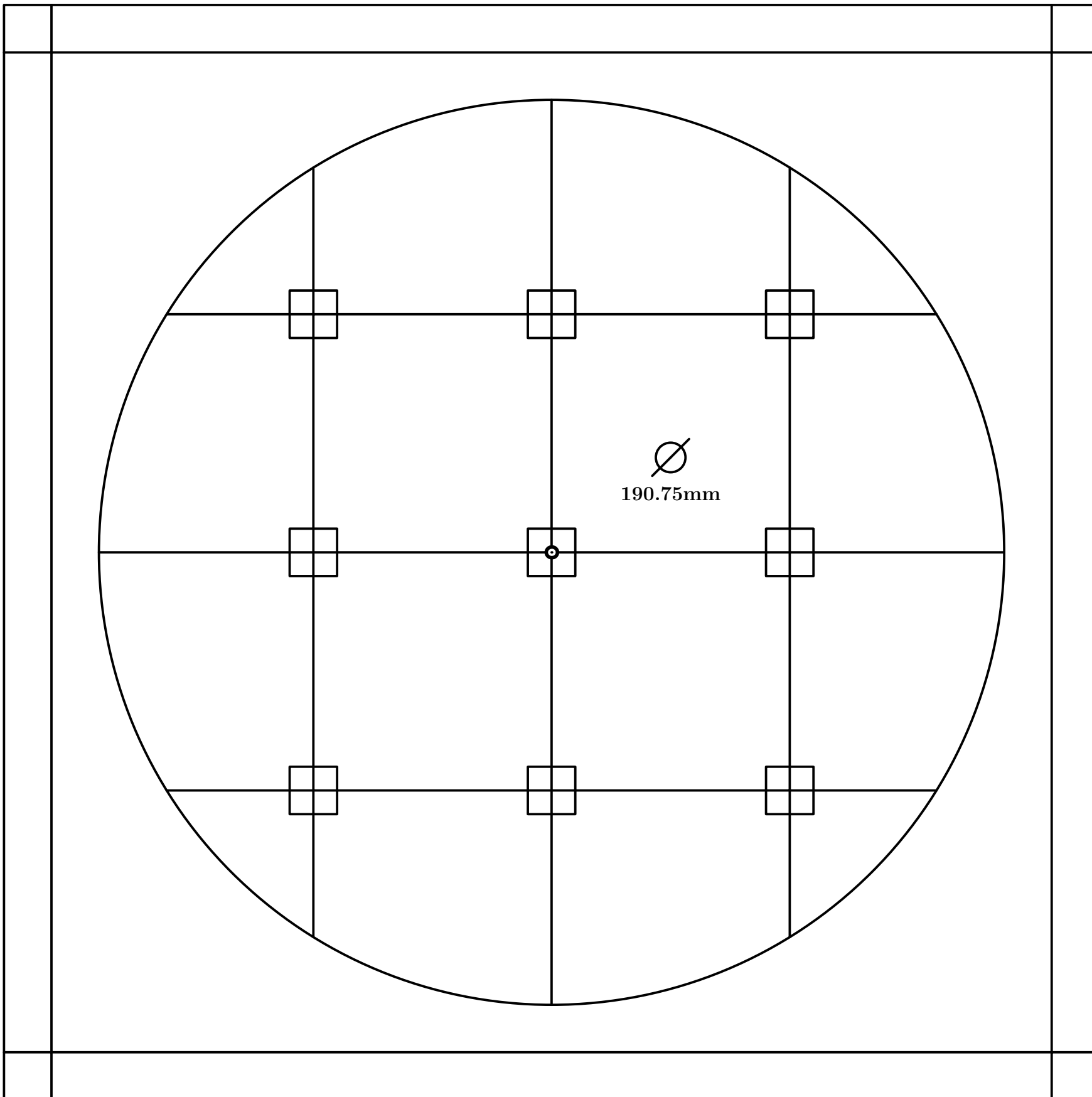

Fig. 364

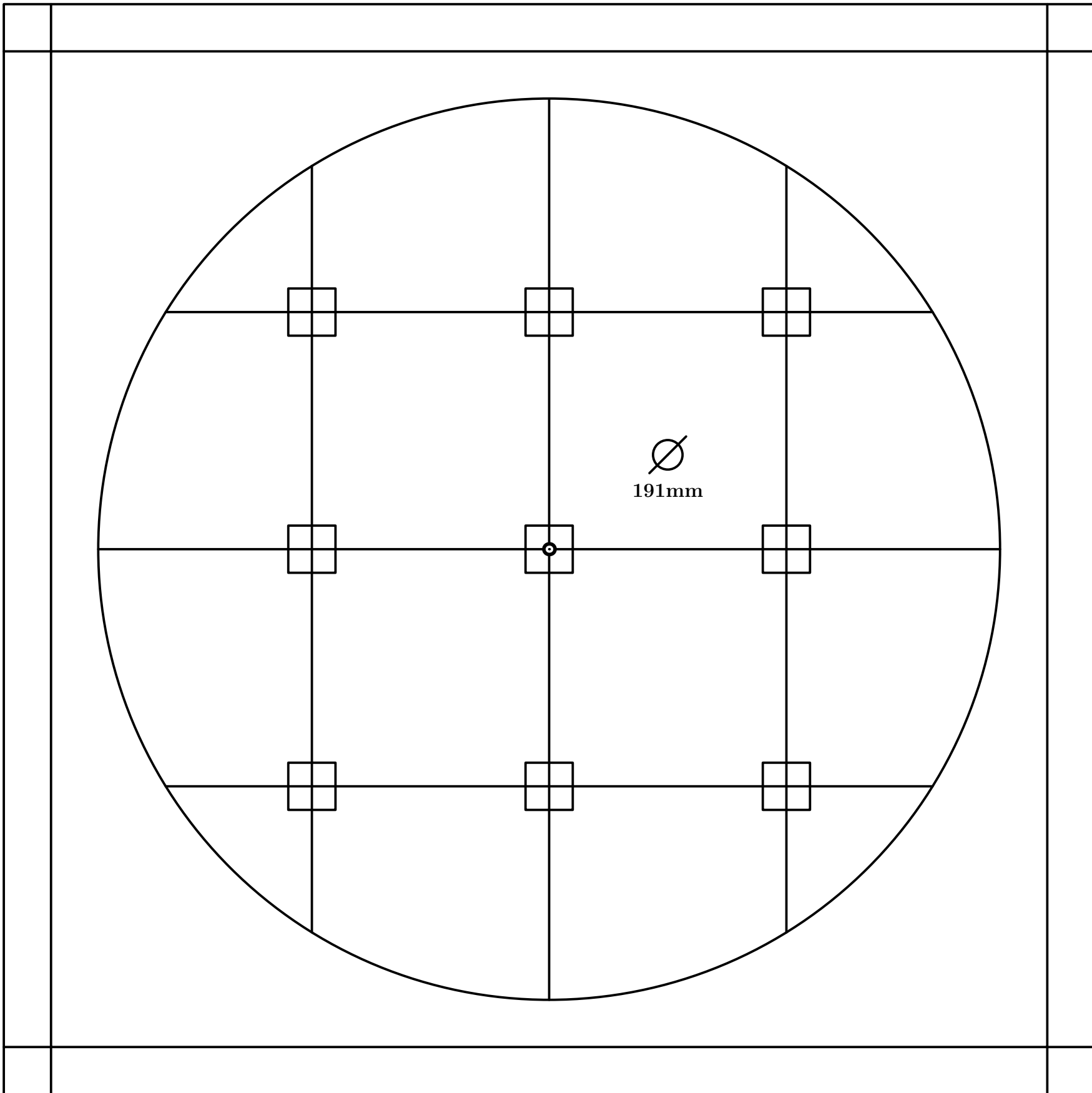

Fig. 365

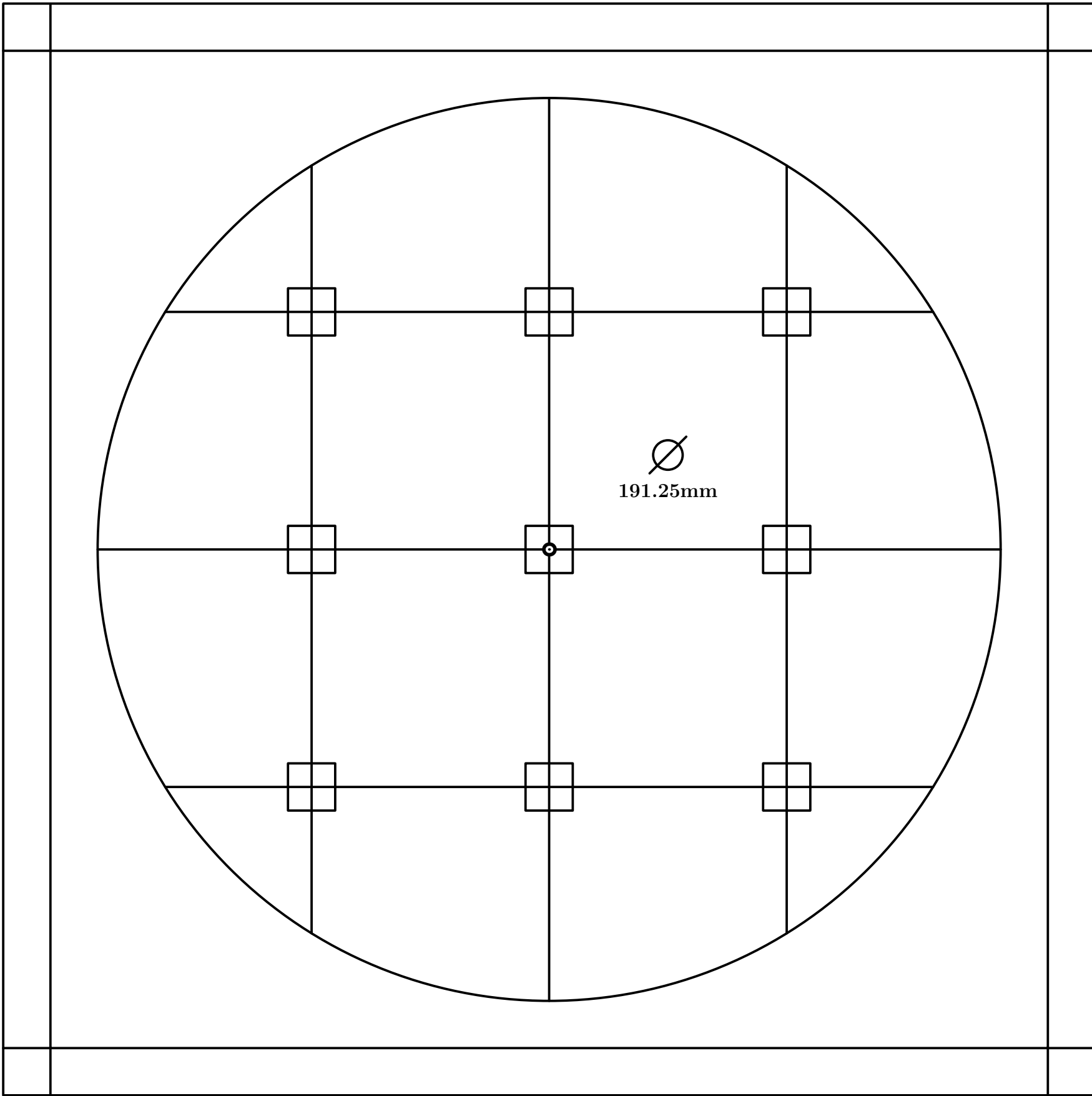

Fig. 366

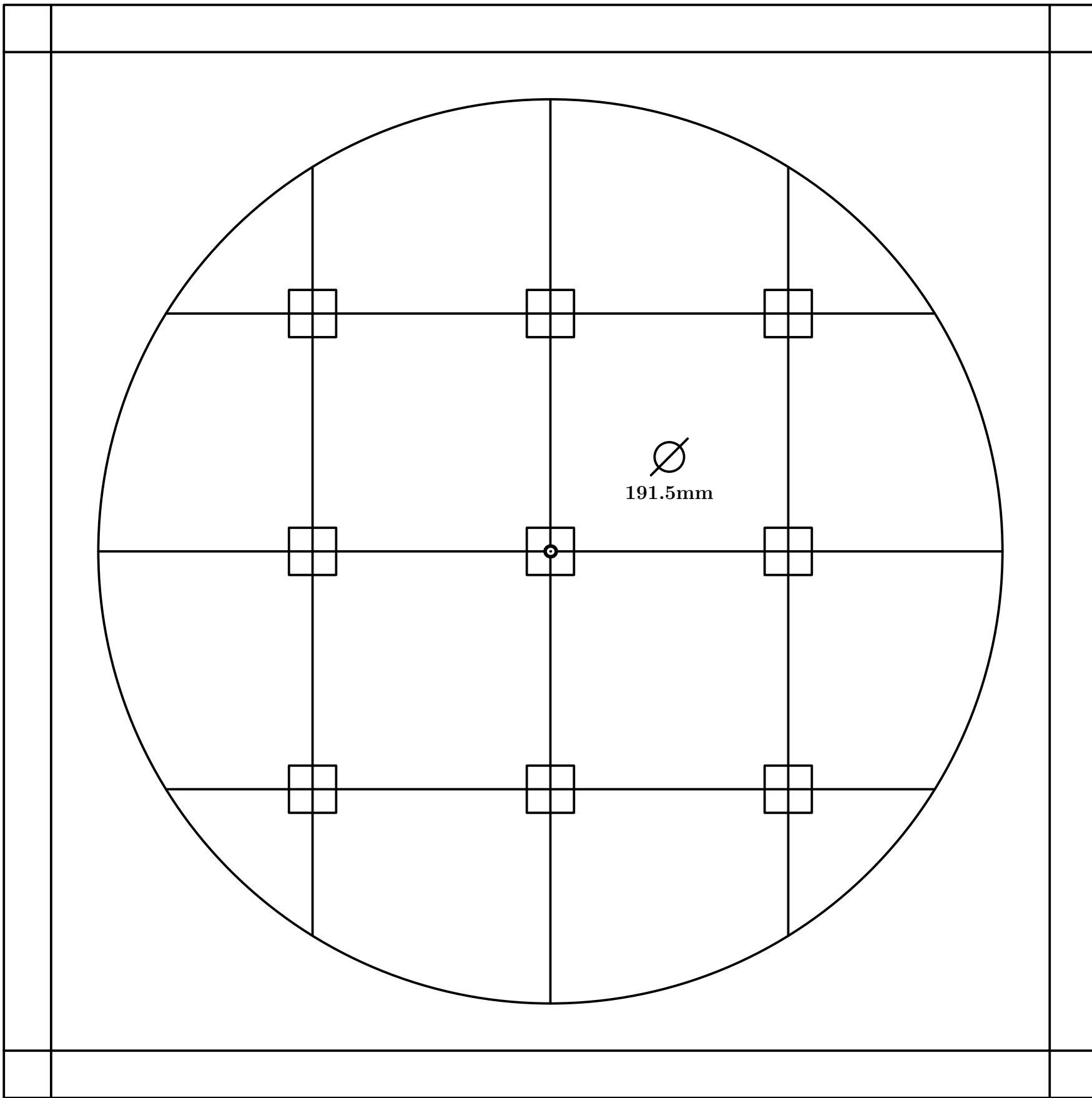

Fig. 367

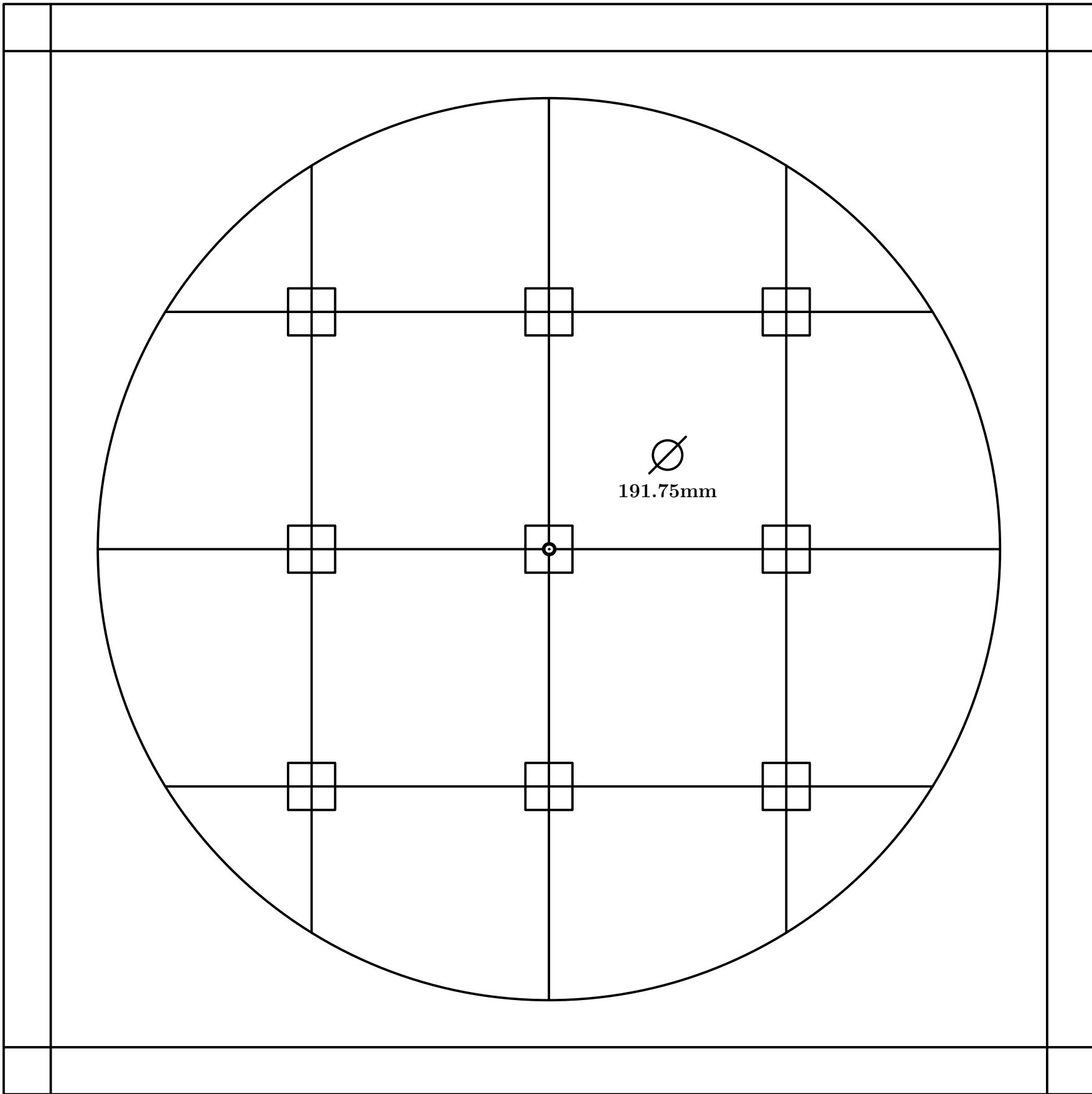

Fig. 368

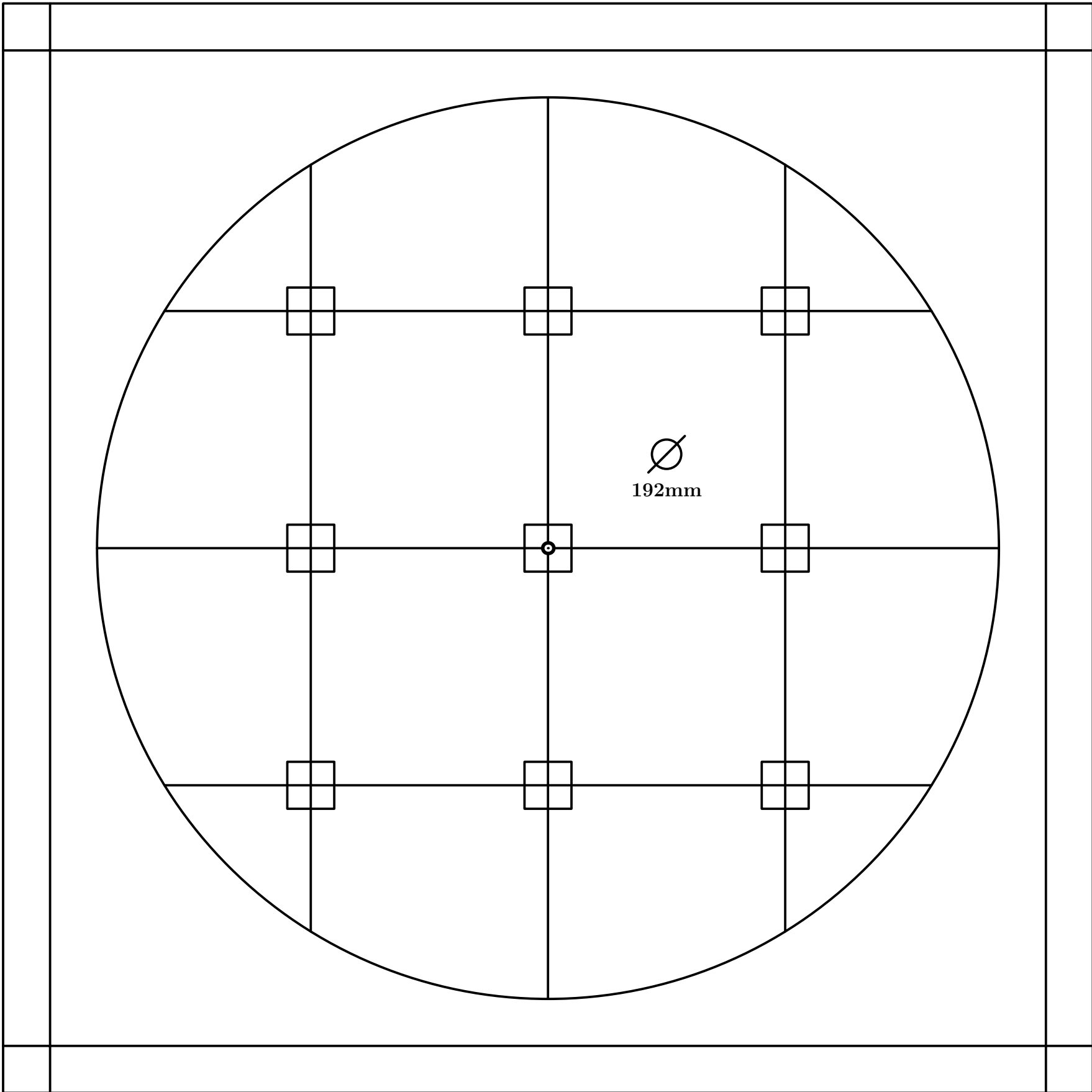

Fig. 369

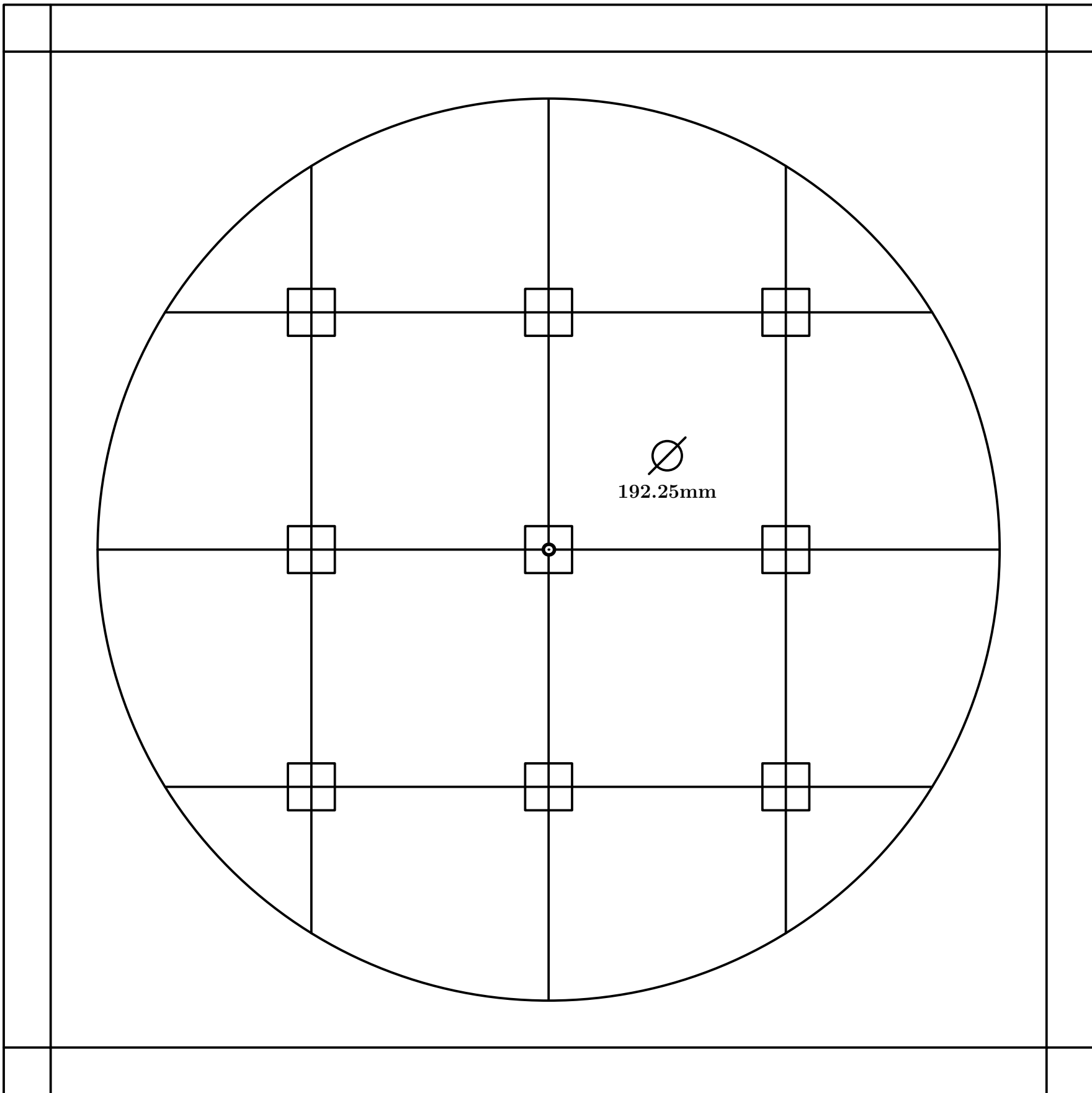

Fig. 370

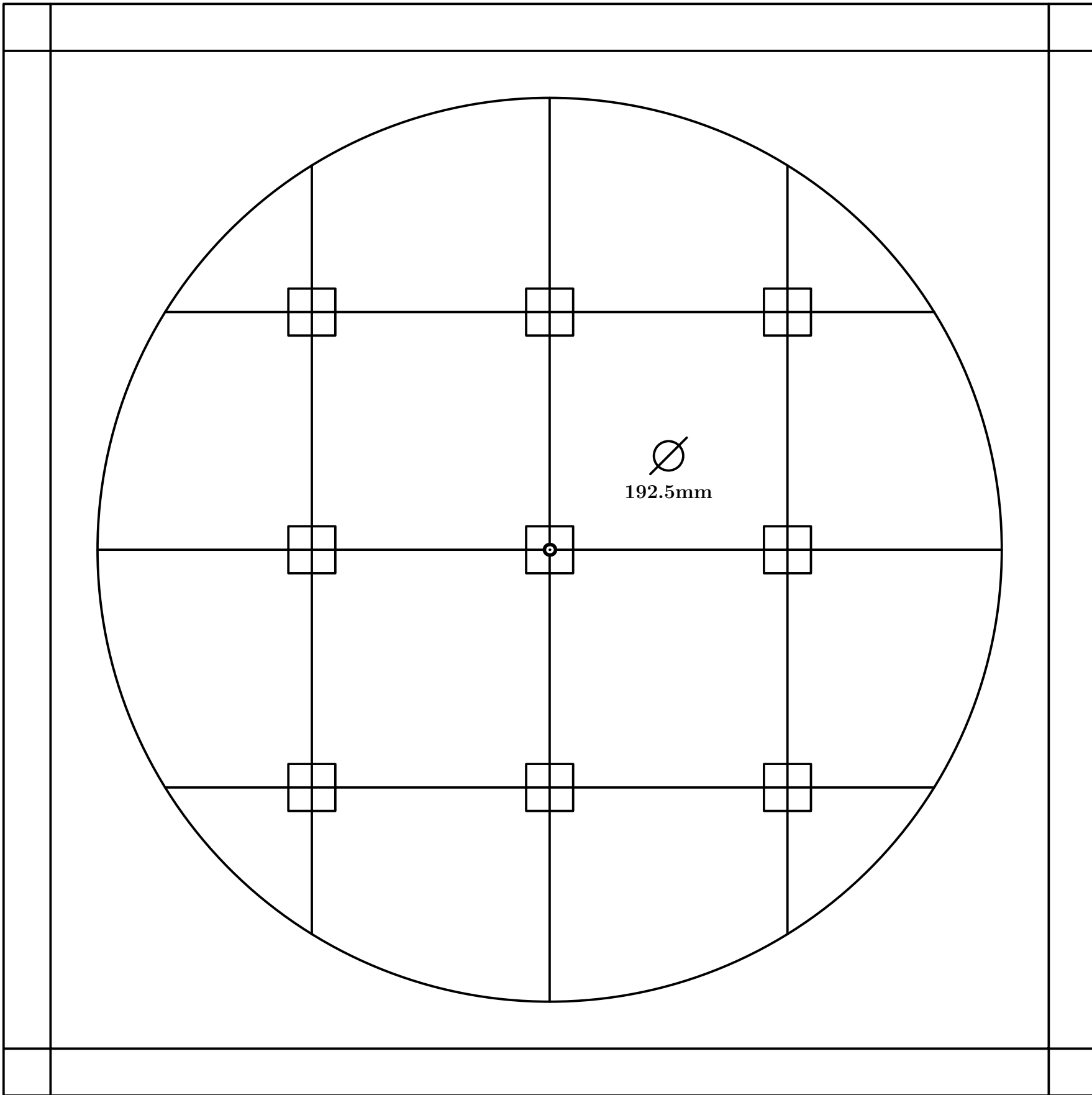

Fig. 371

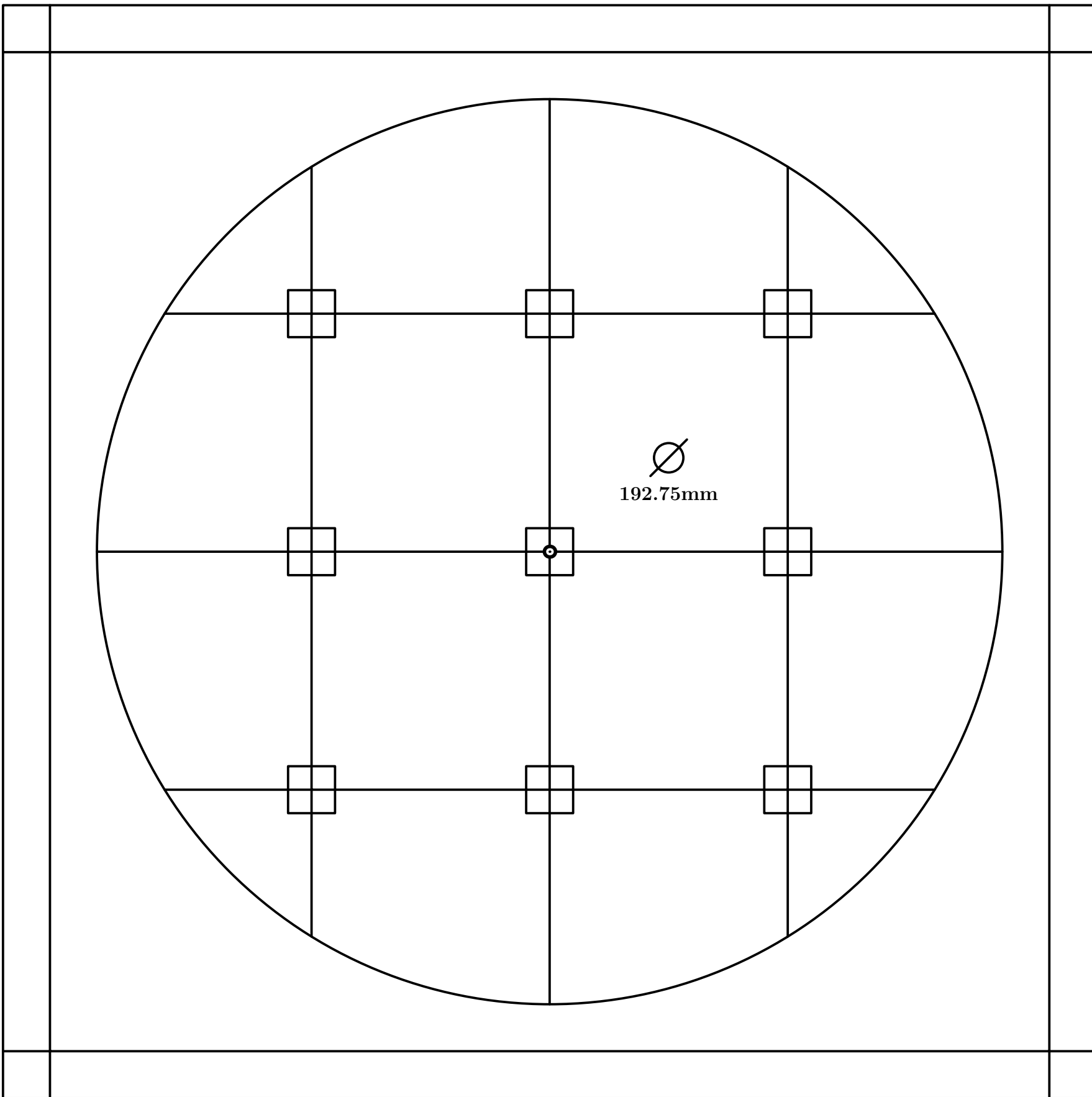

Fig. 372

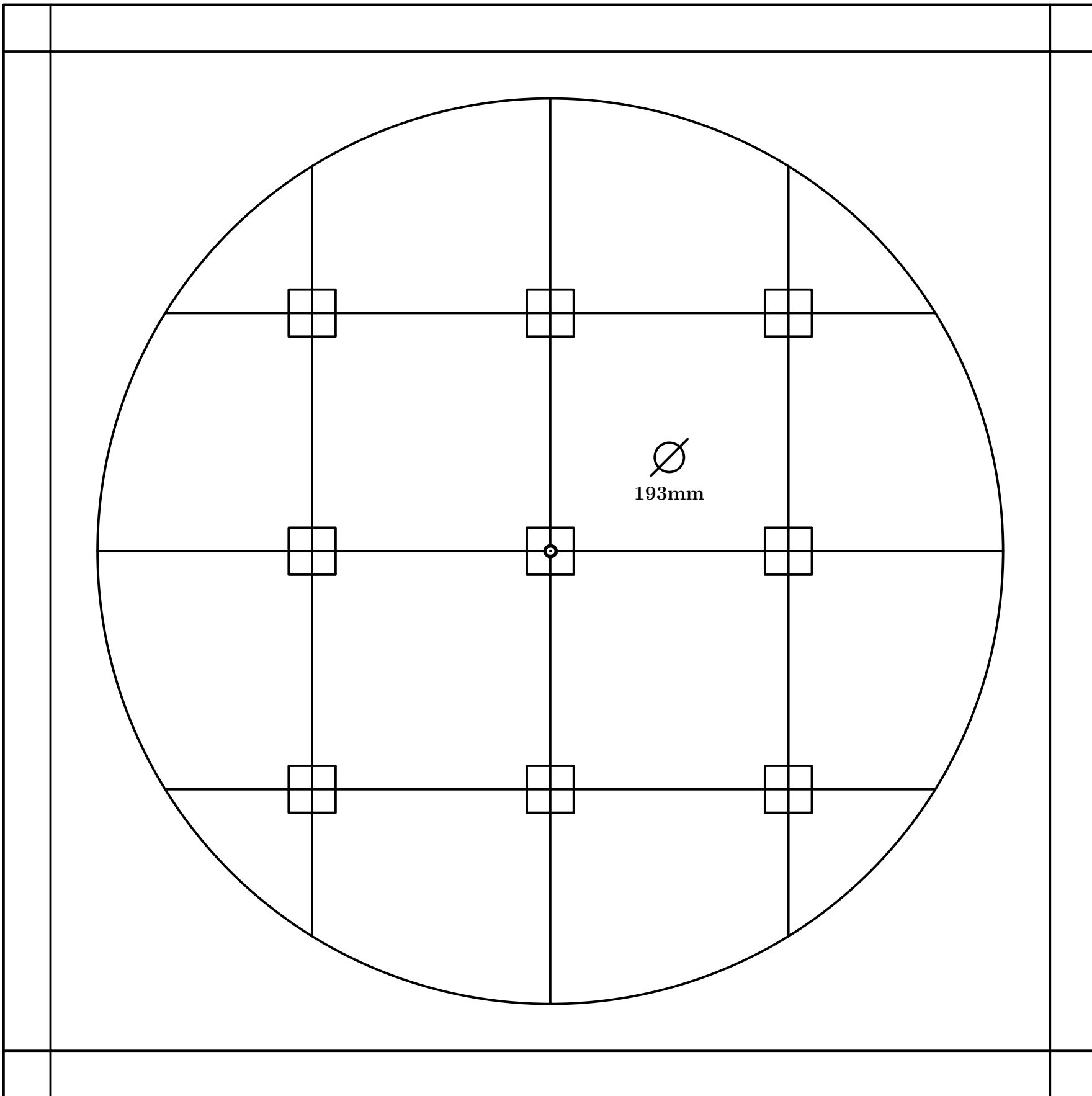

Fig. 373

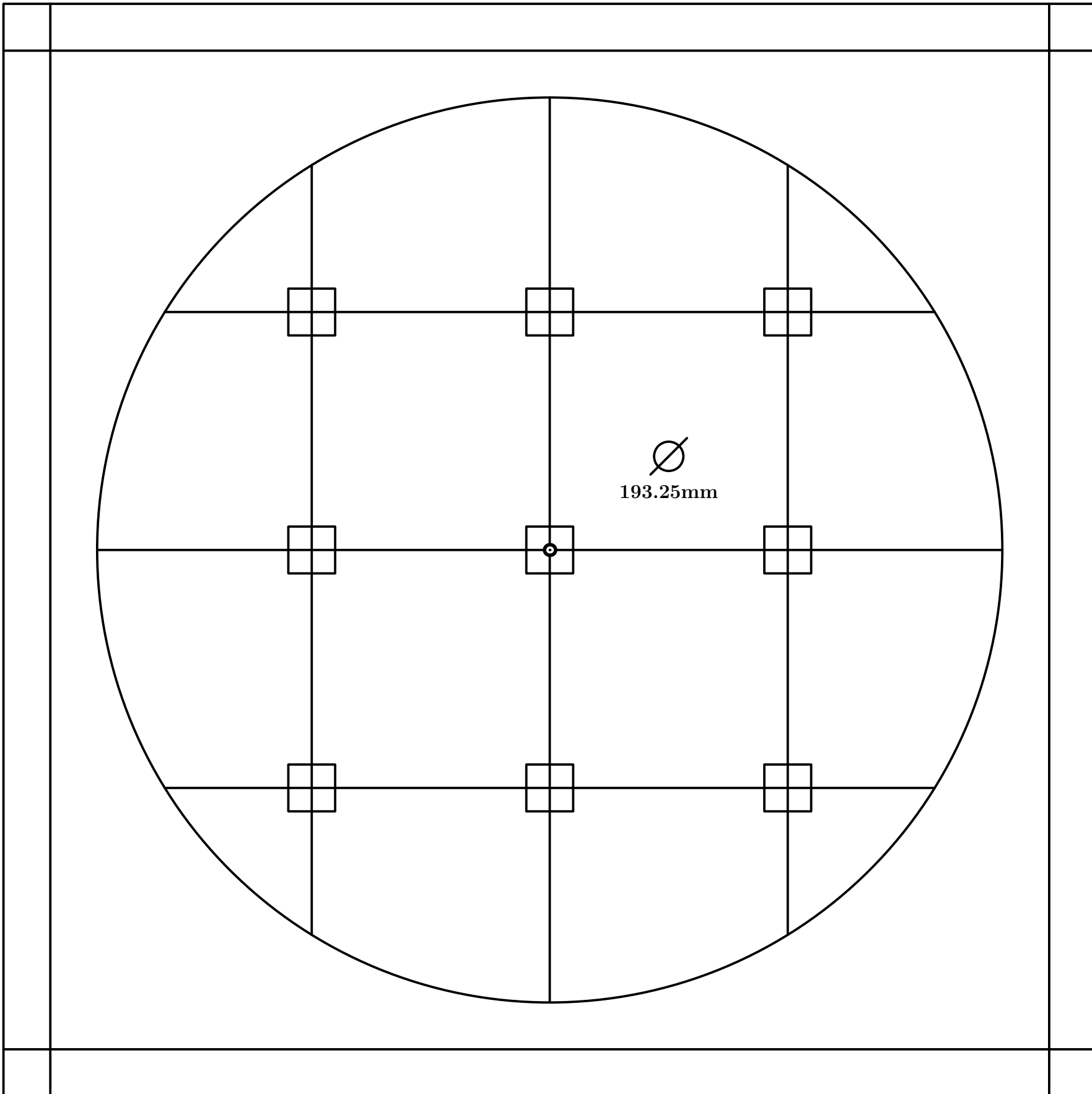

Fig. 374

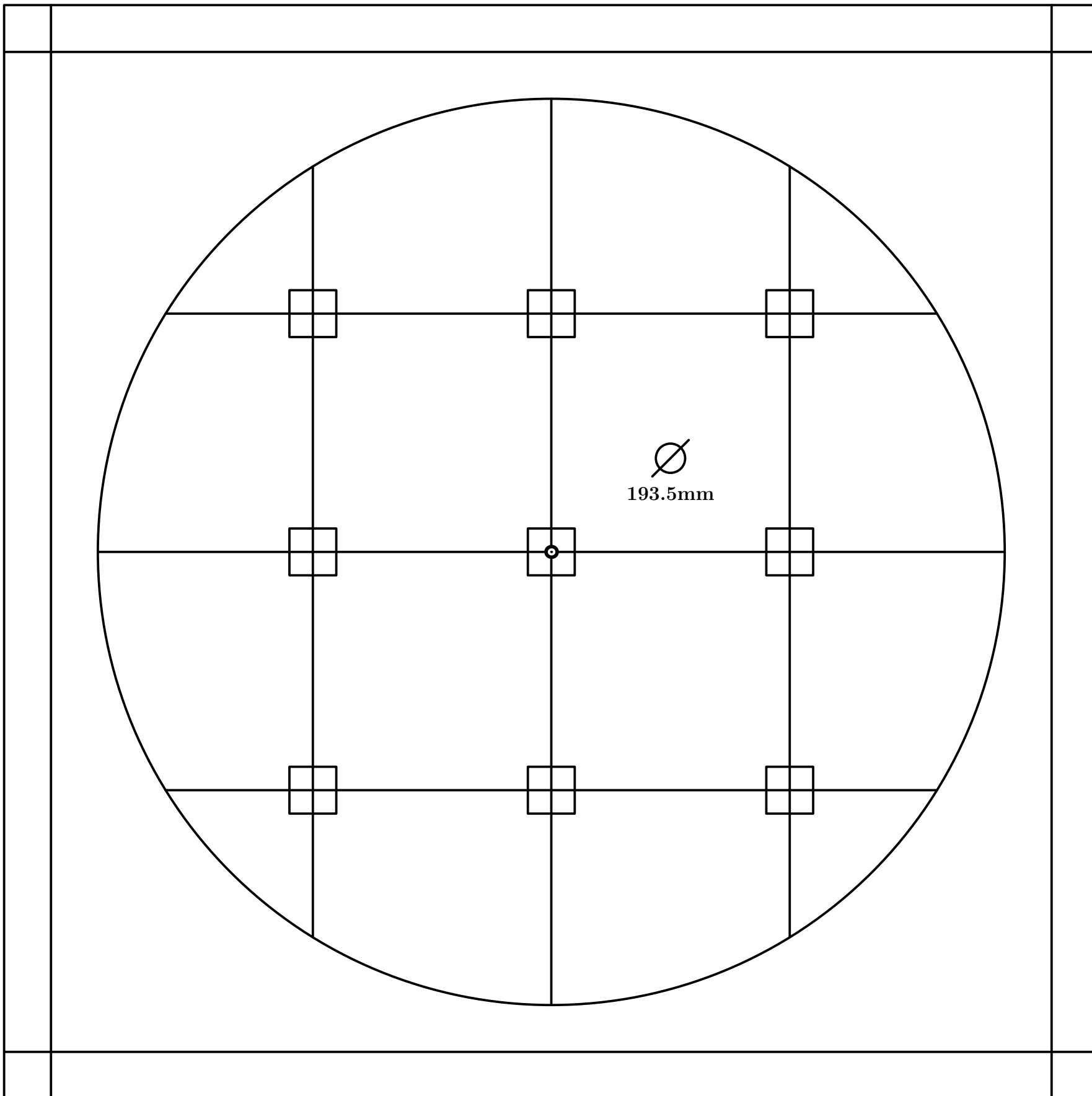

Fig. 375

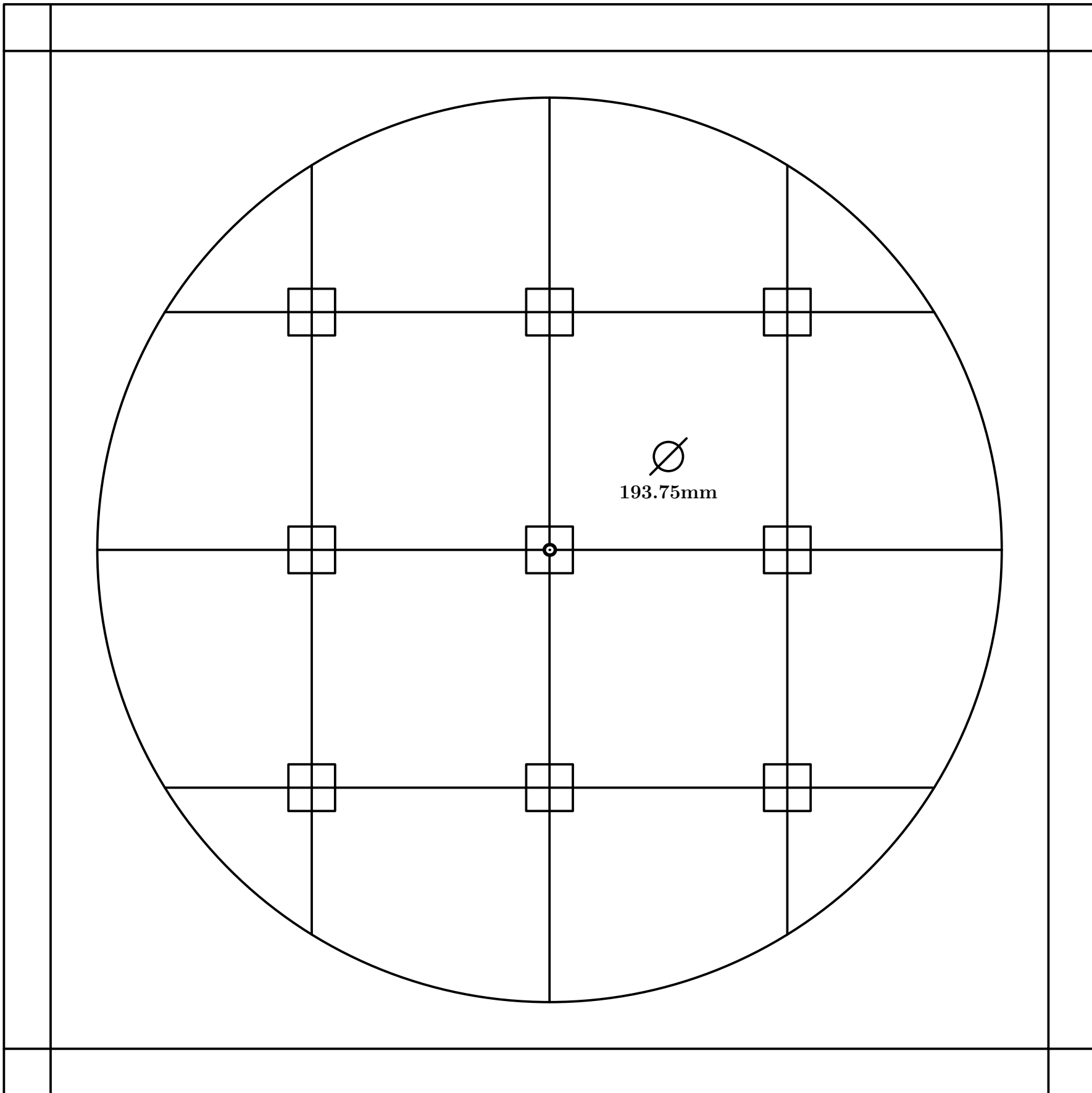

Fig. 376

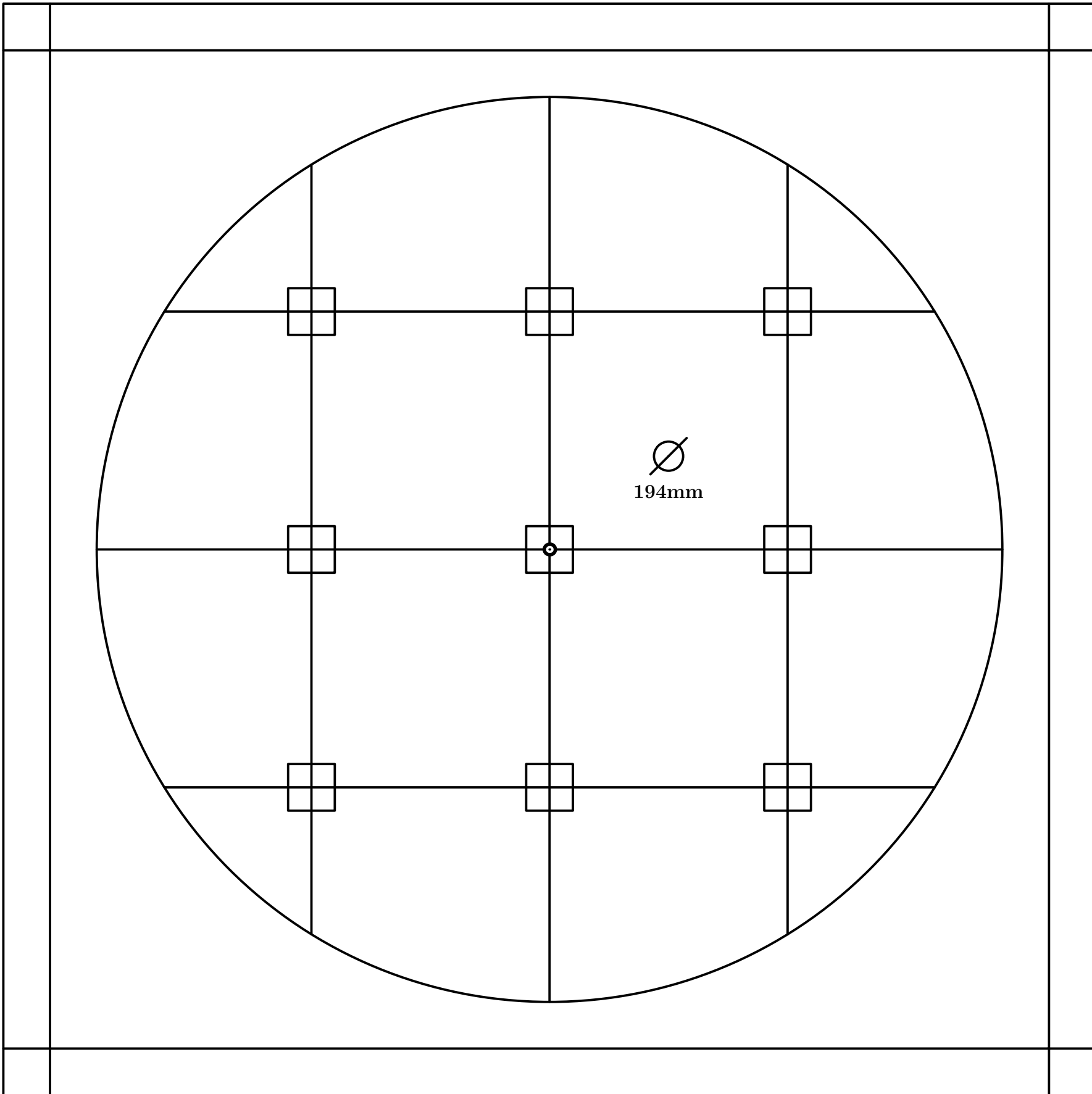

Fig. 377

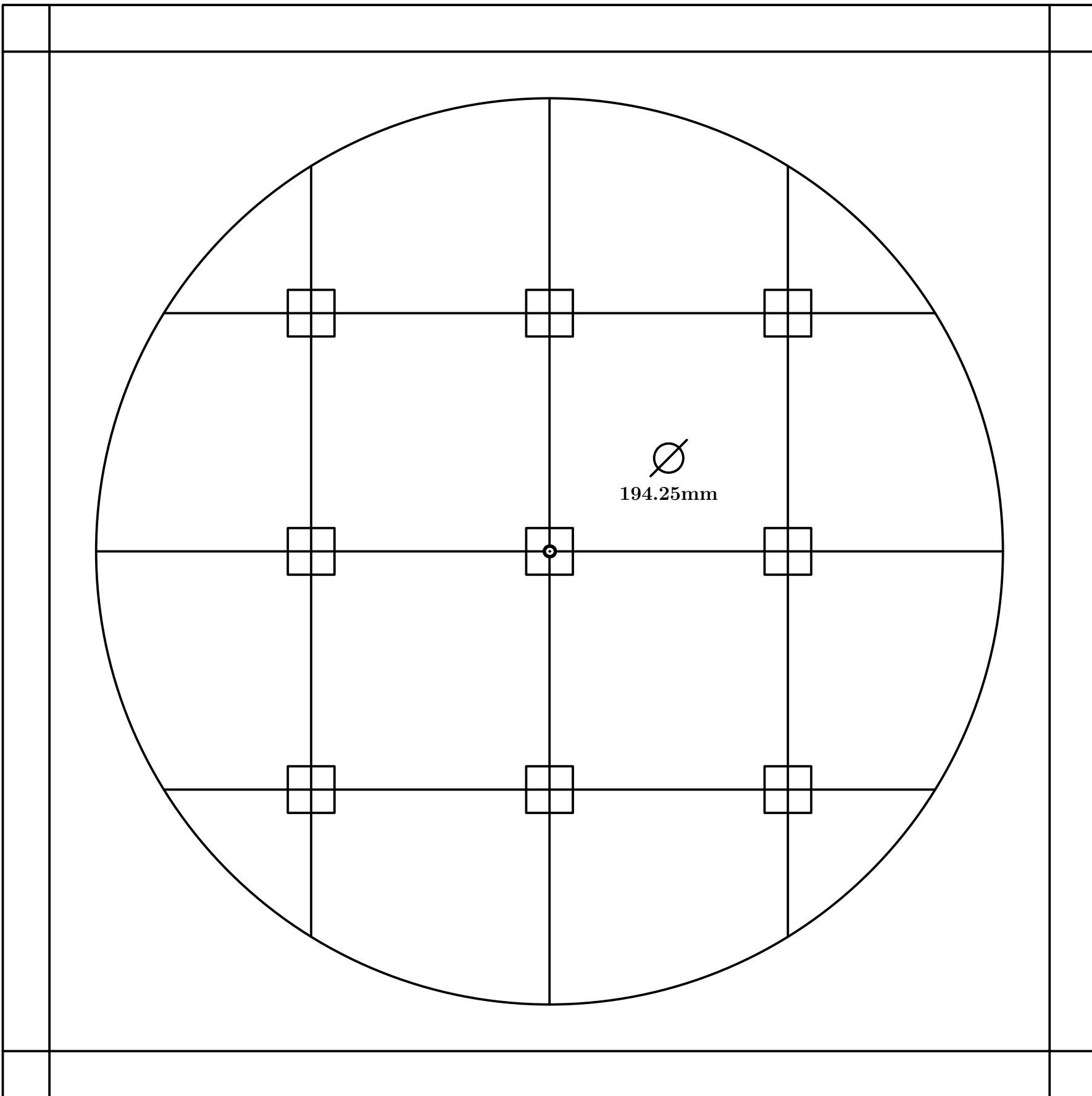

Fig. 378

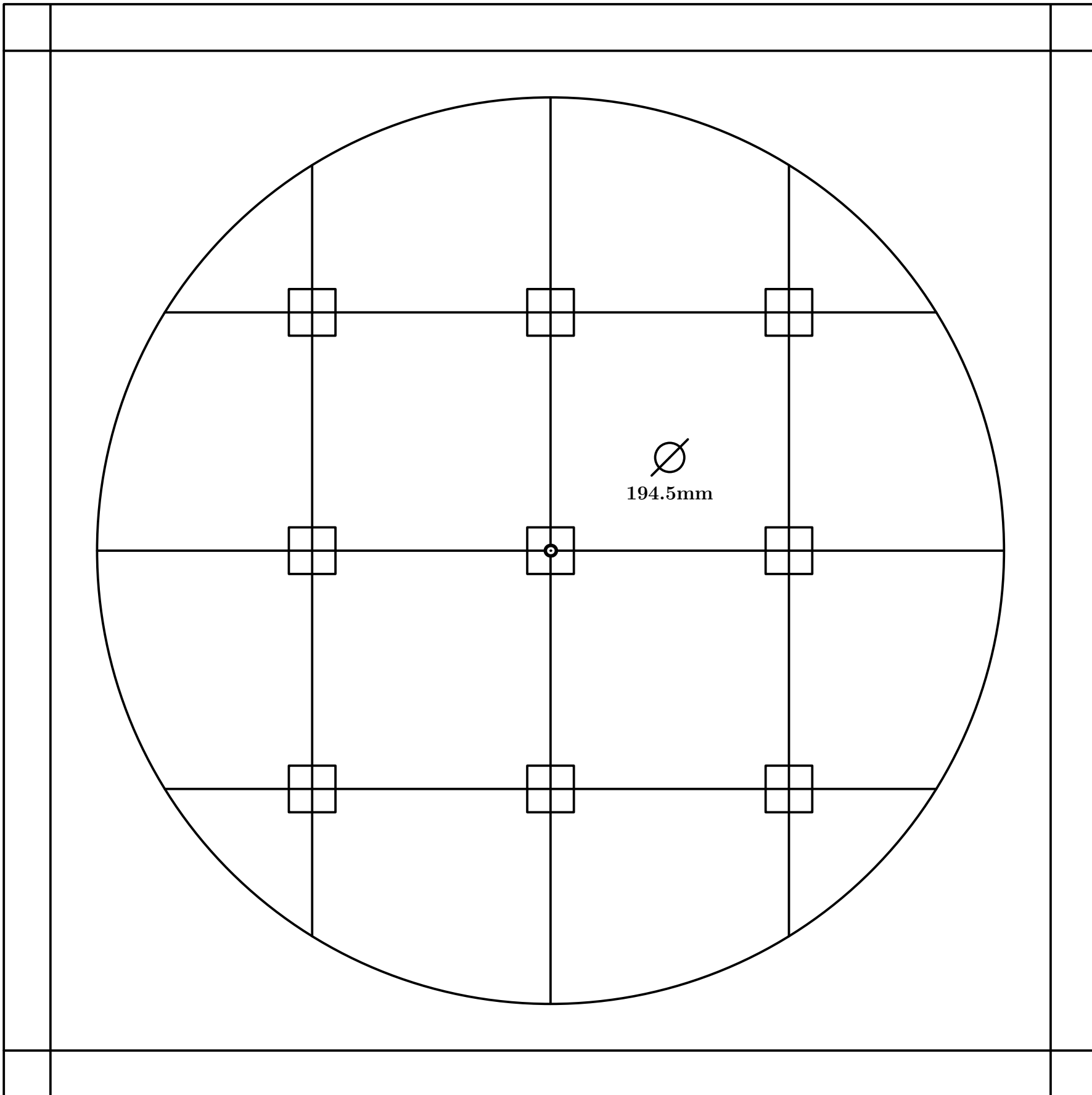

Fig. 379

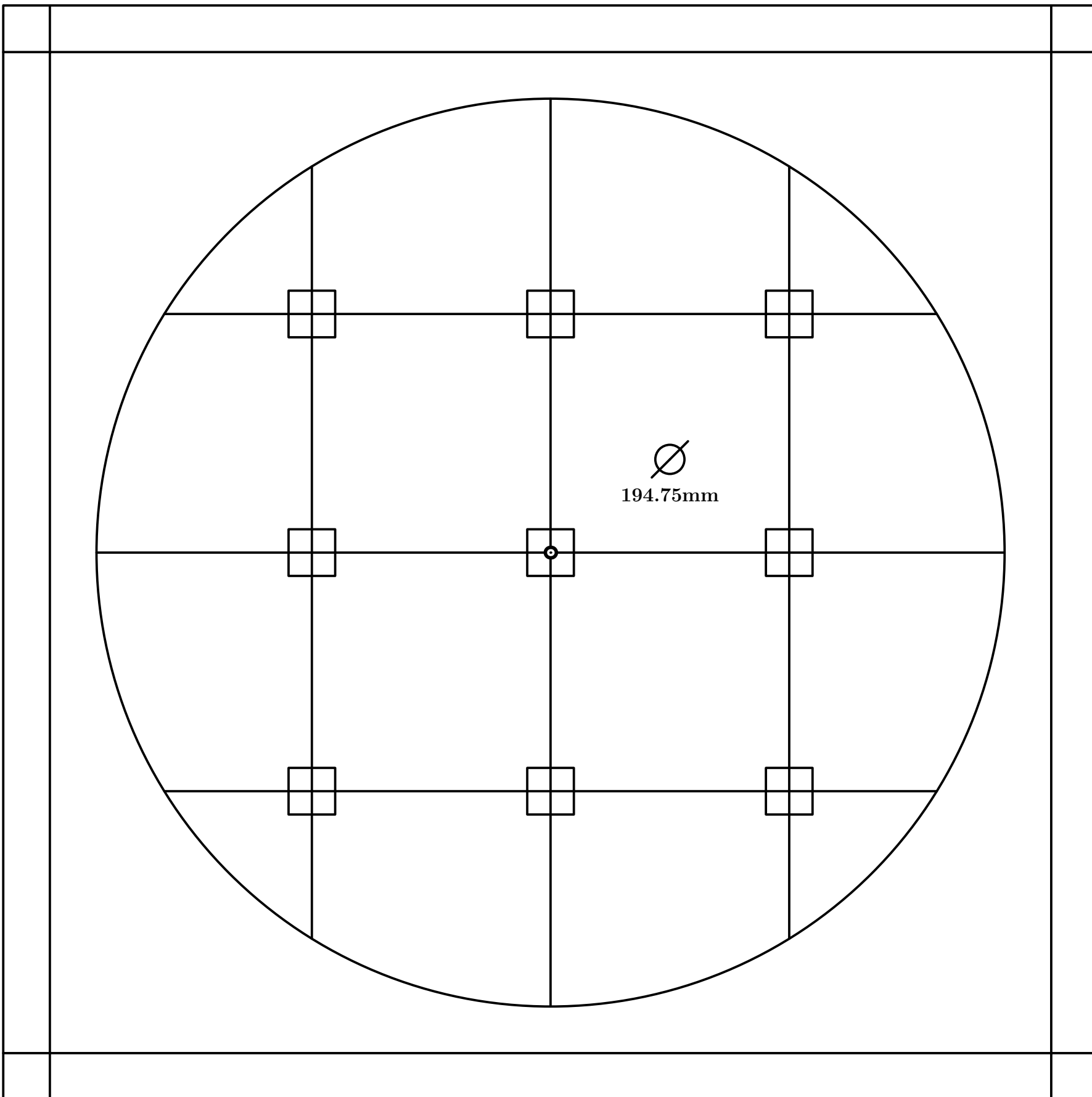

Fig. 380

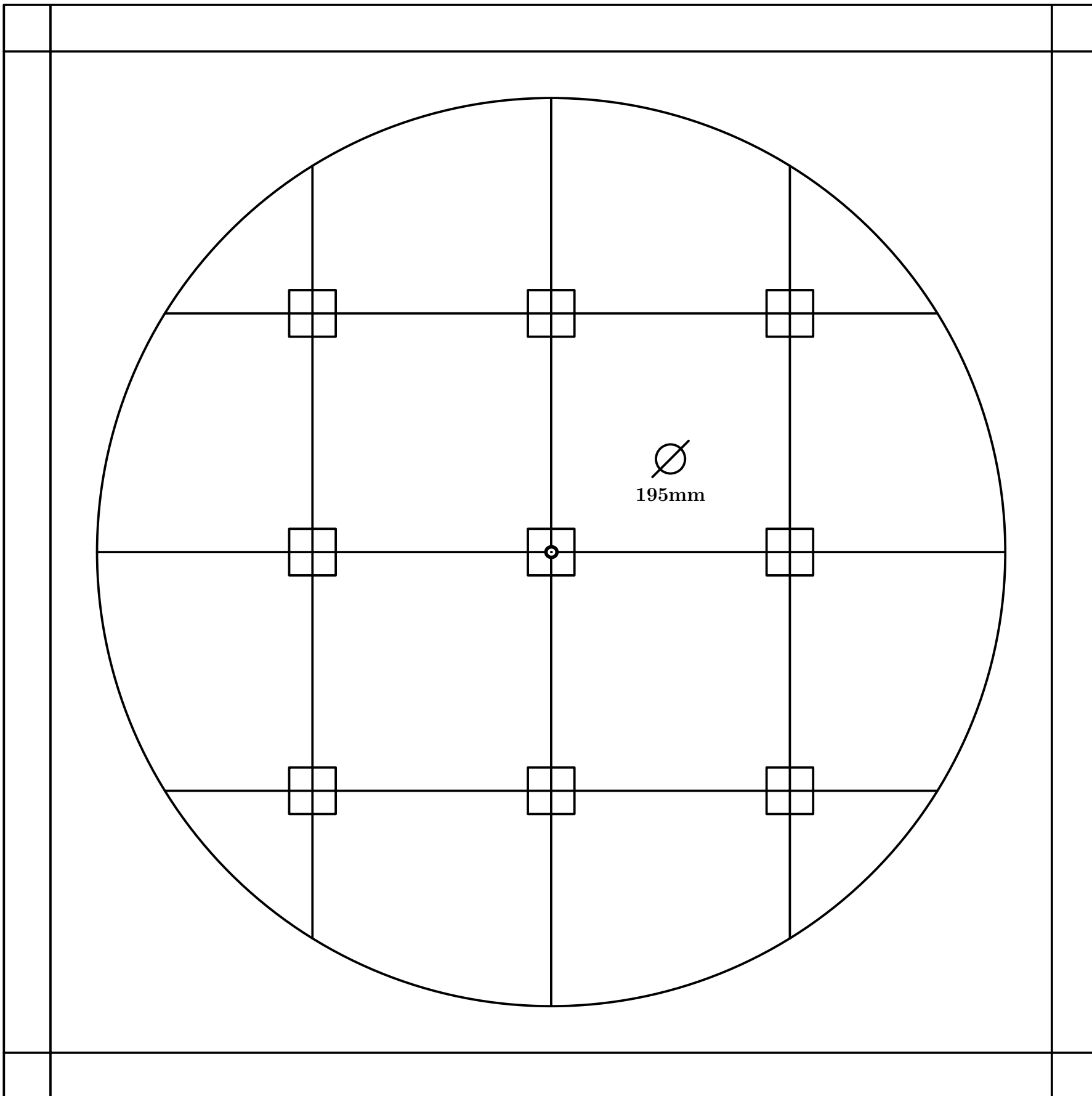

Fig. 381

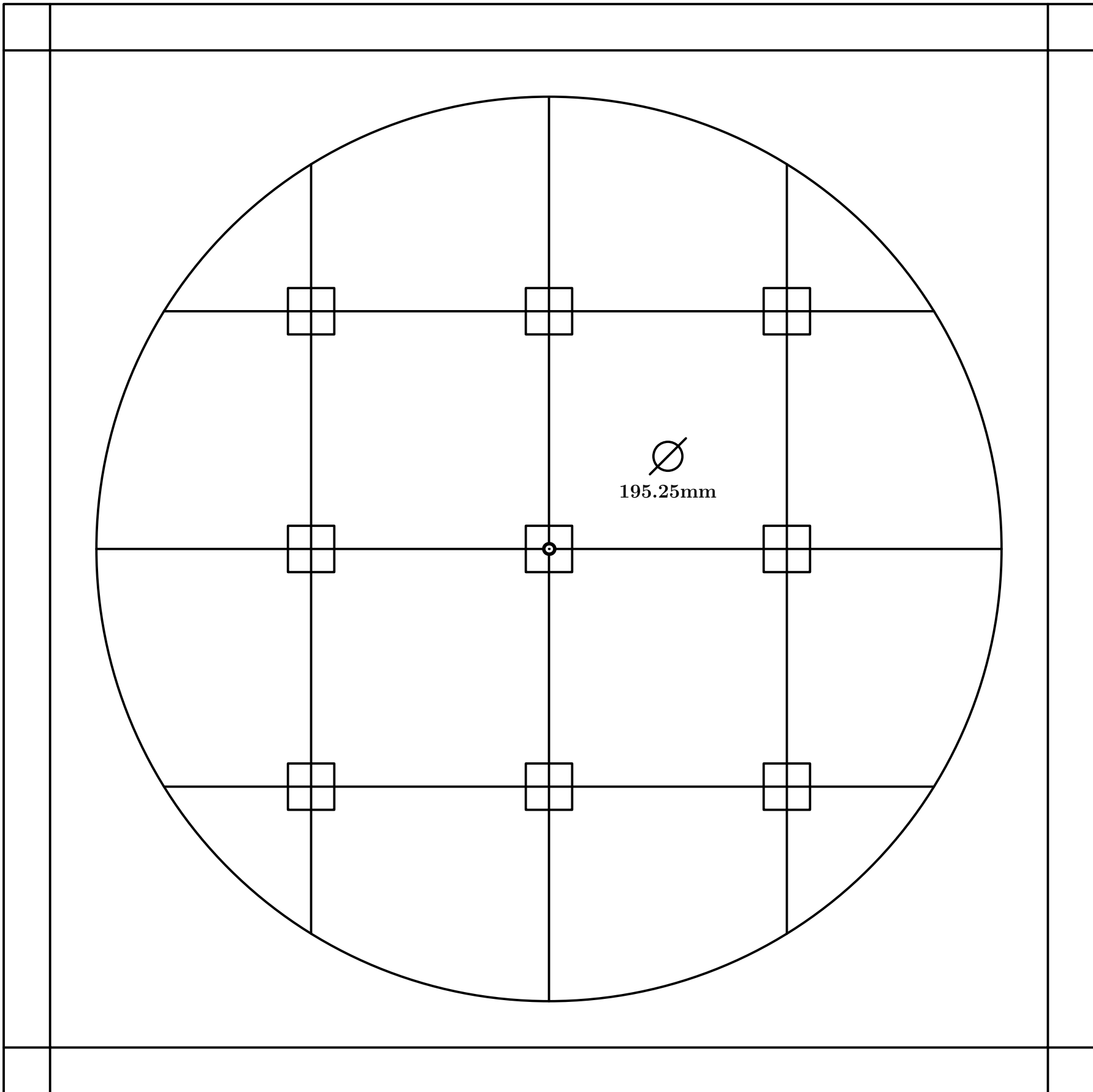

Fig. 382

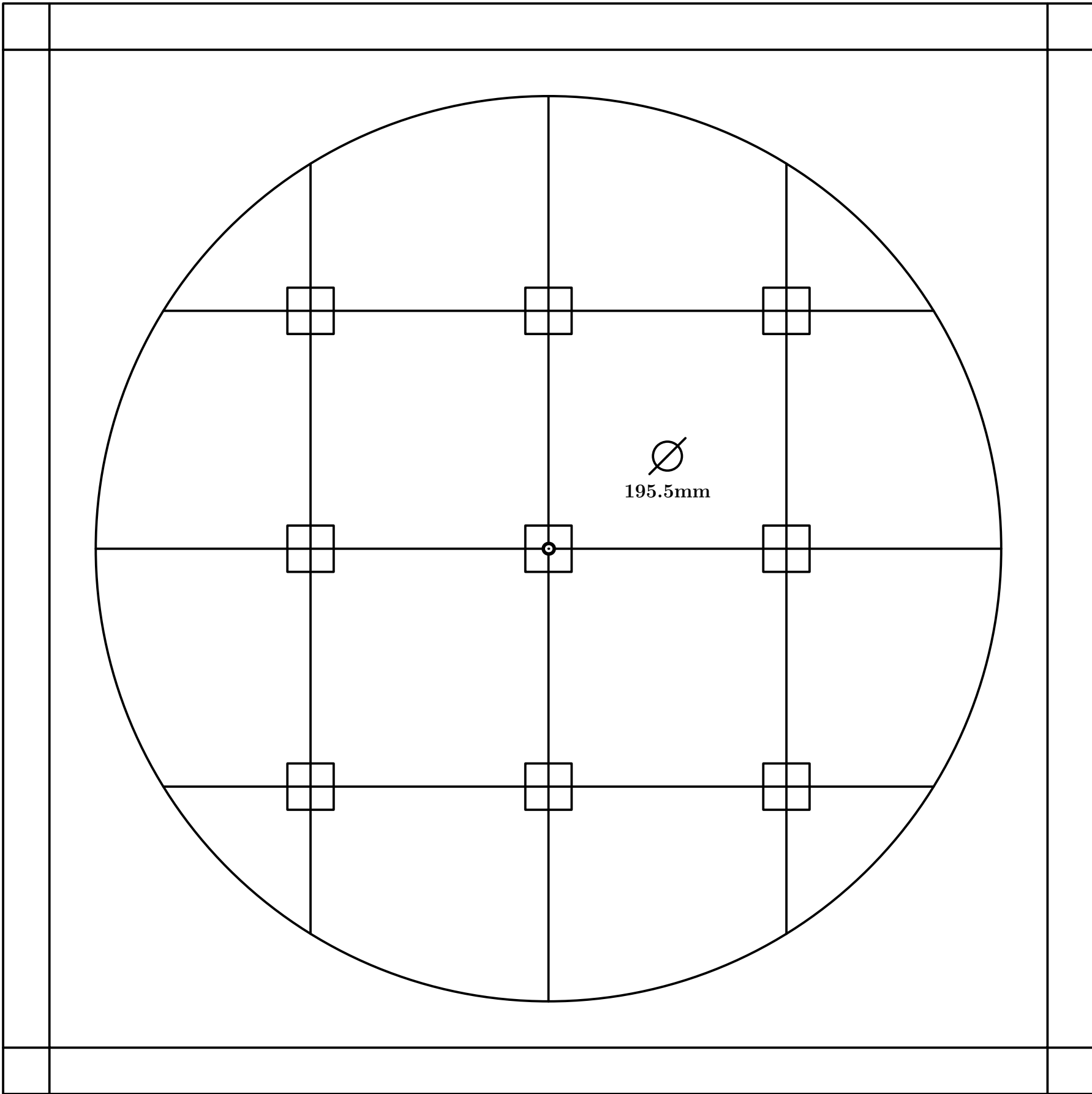

Fig. 383

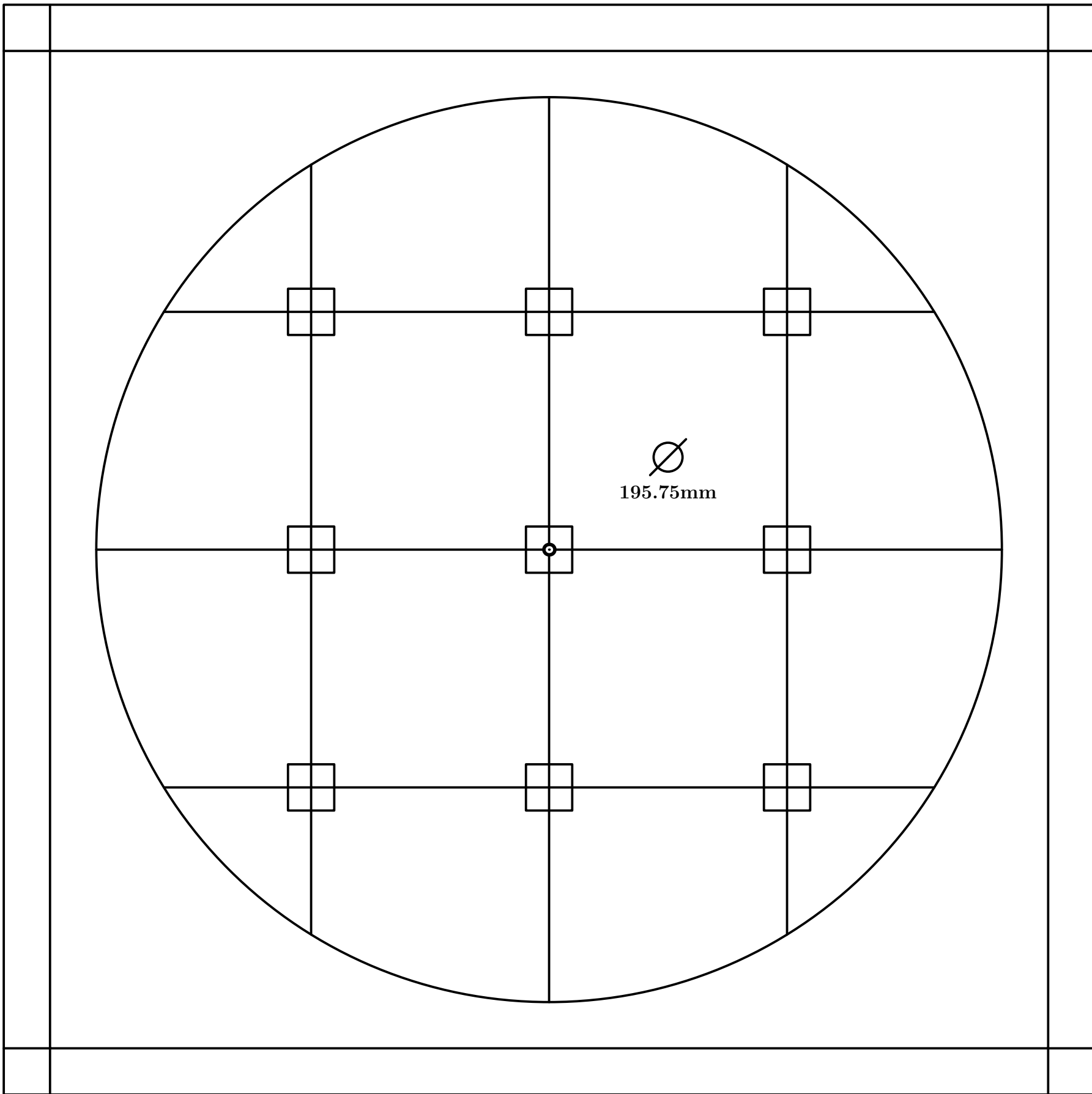

Fig. 384

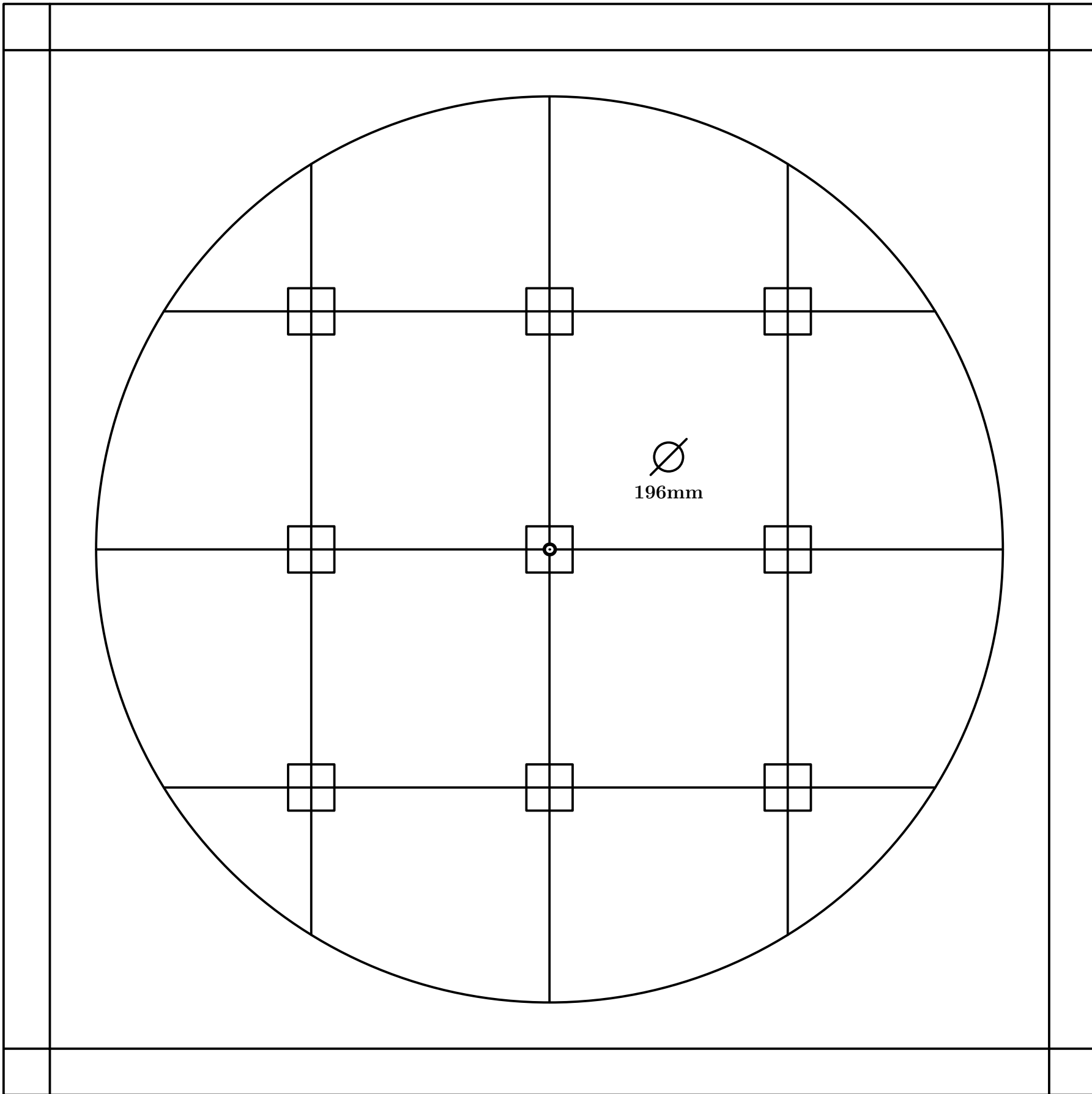

Fig. 385

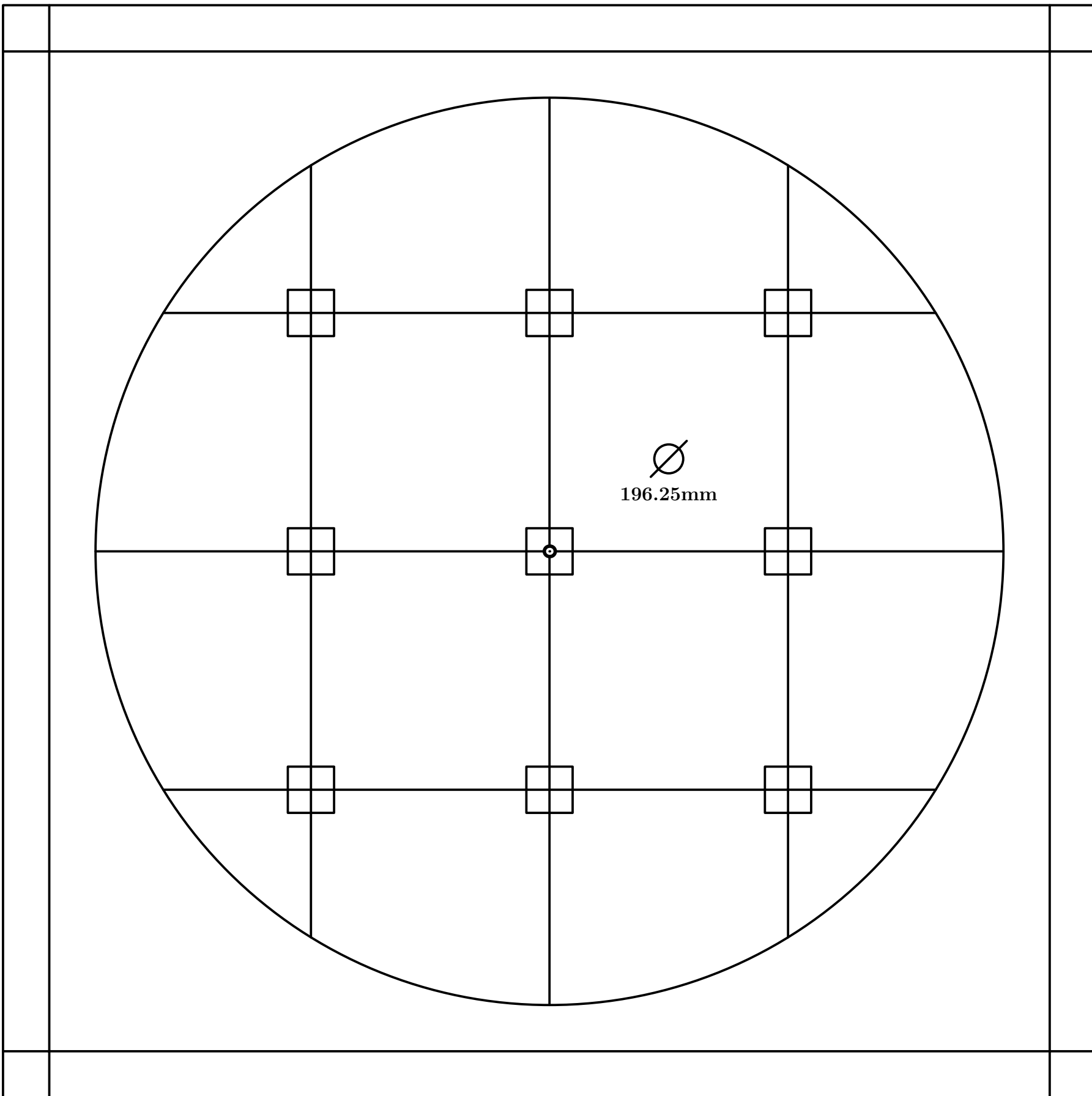

Fig. 386

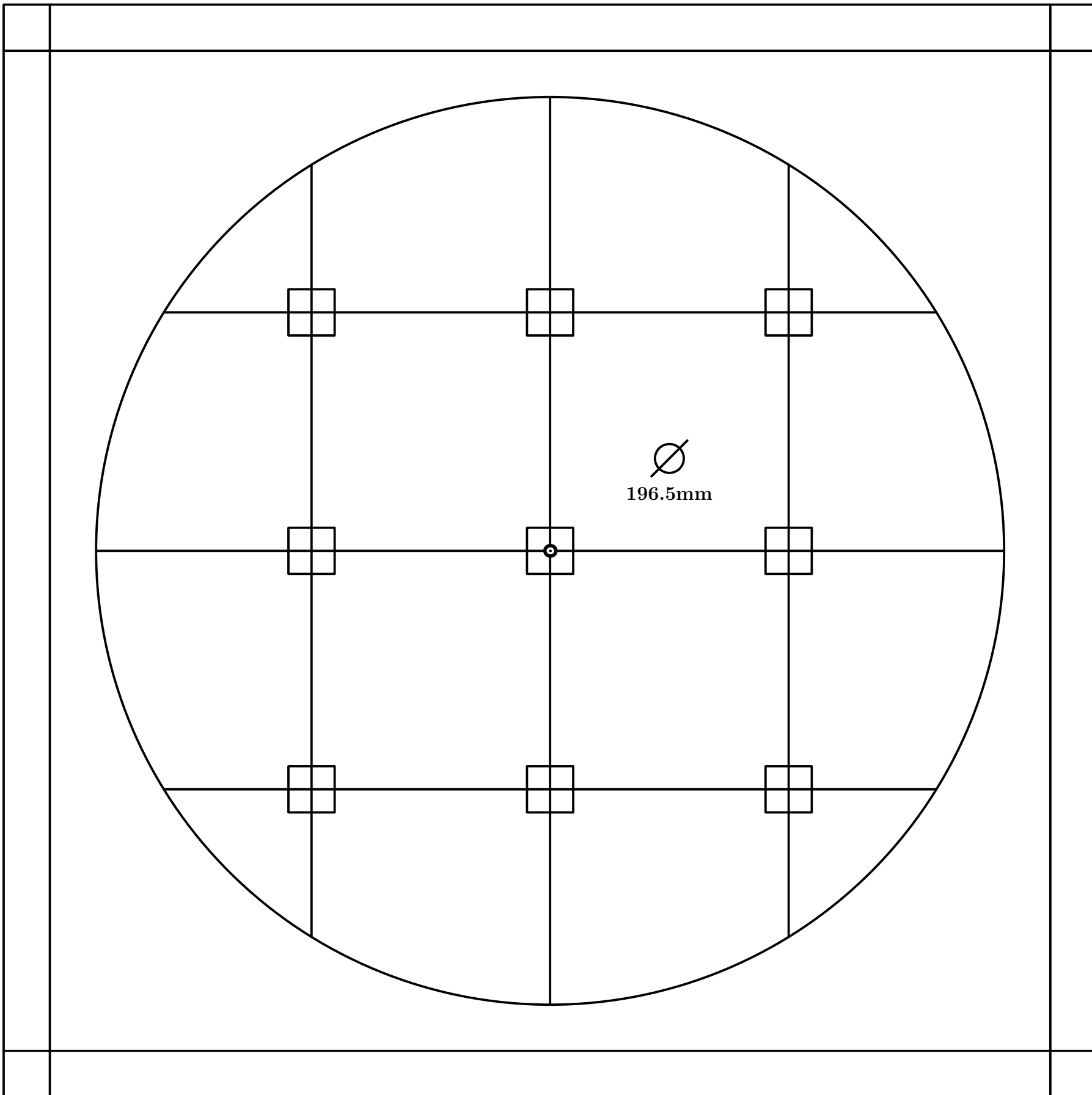

Fig. 387

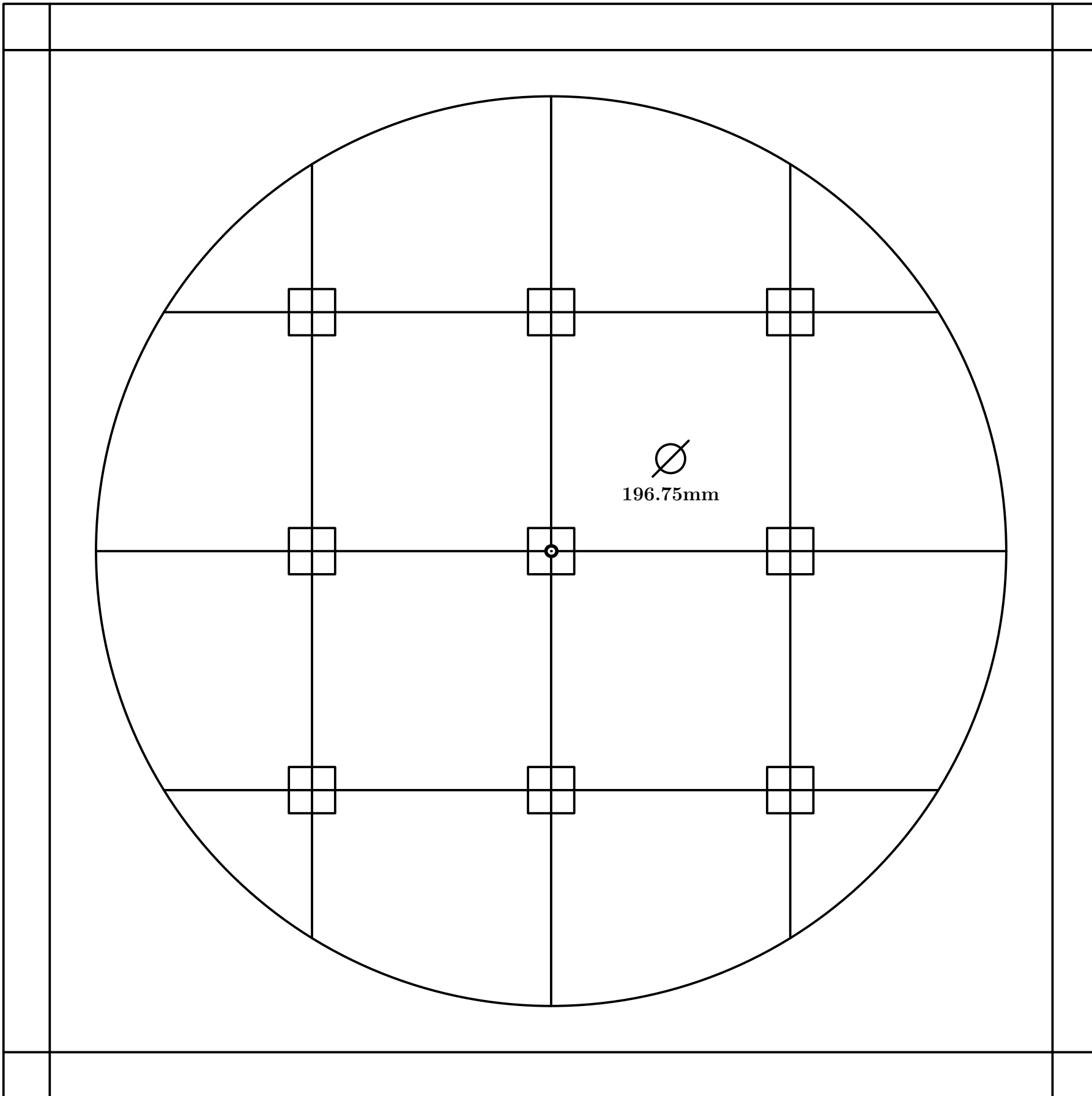

Fig. 388

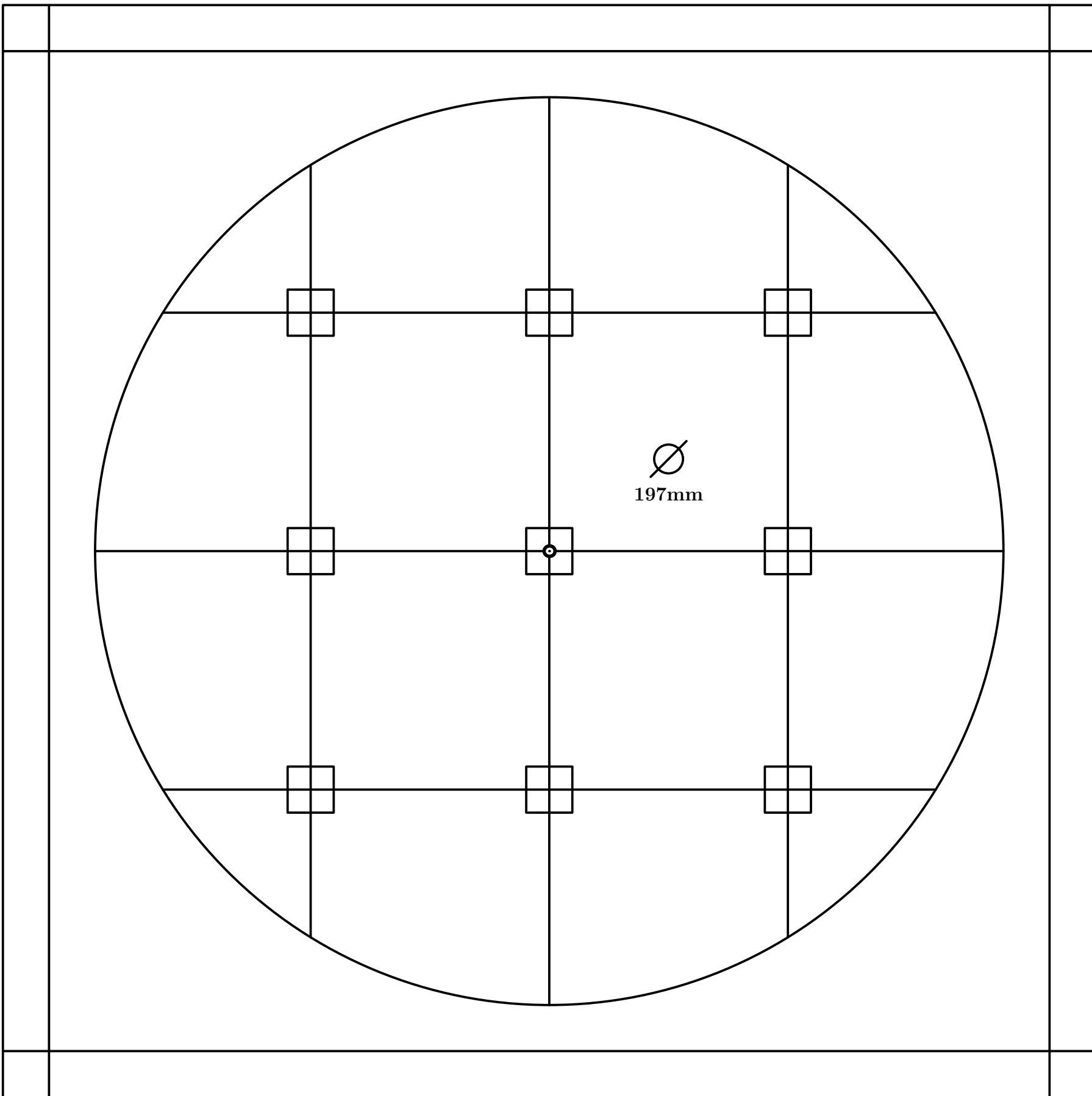

Fig. 389

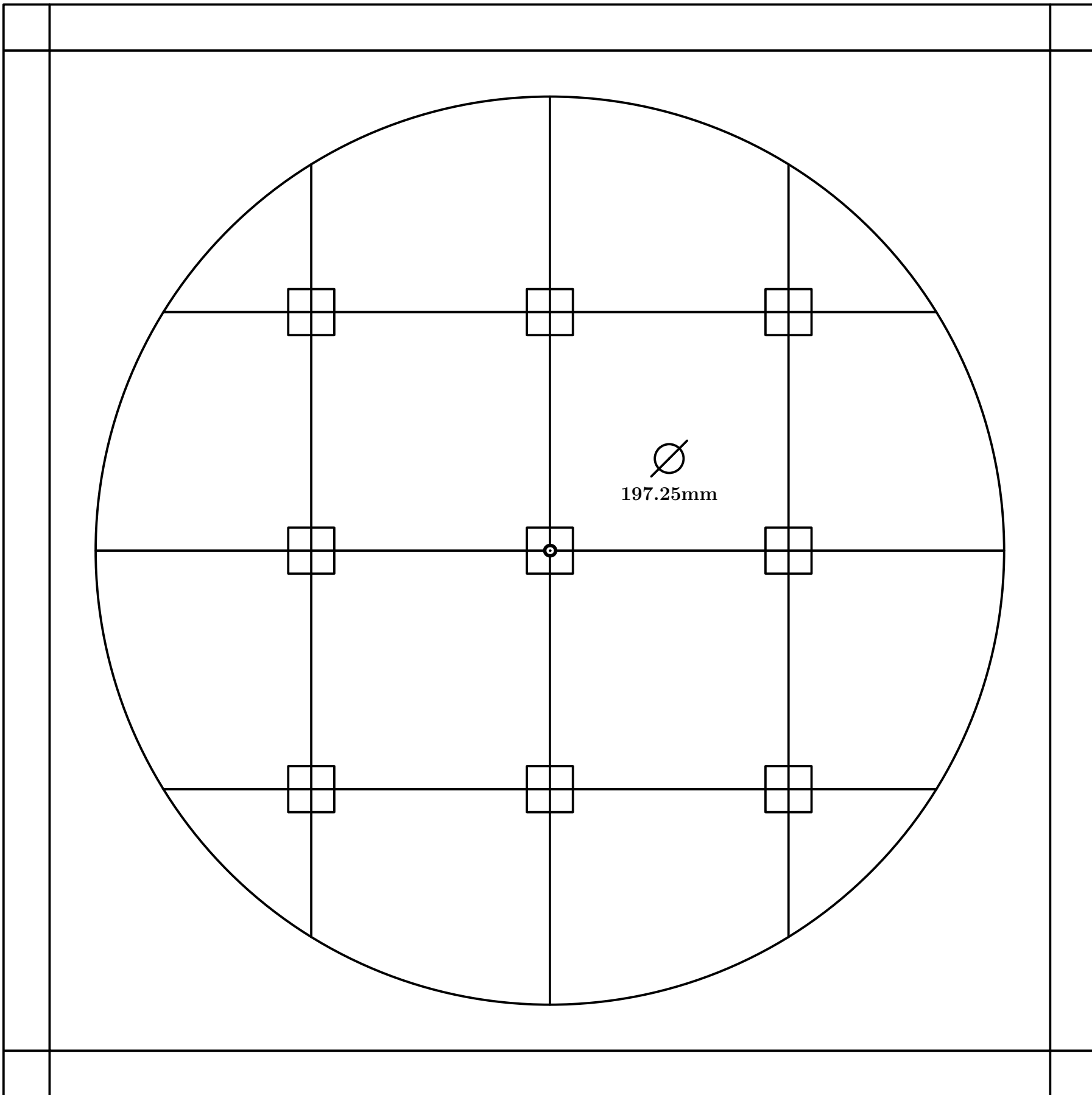

Fig. 390

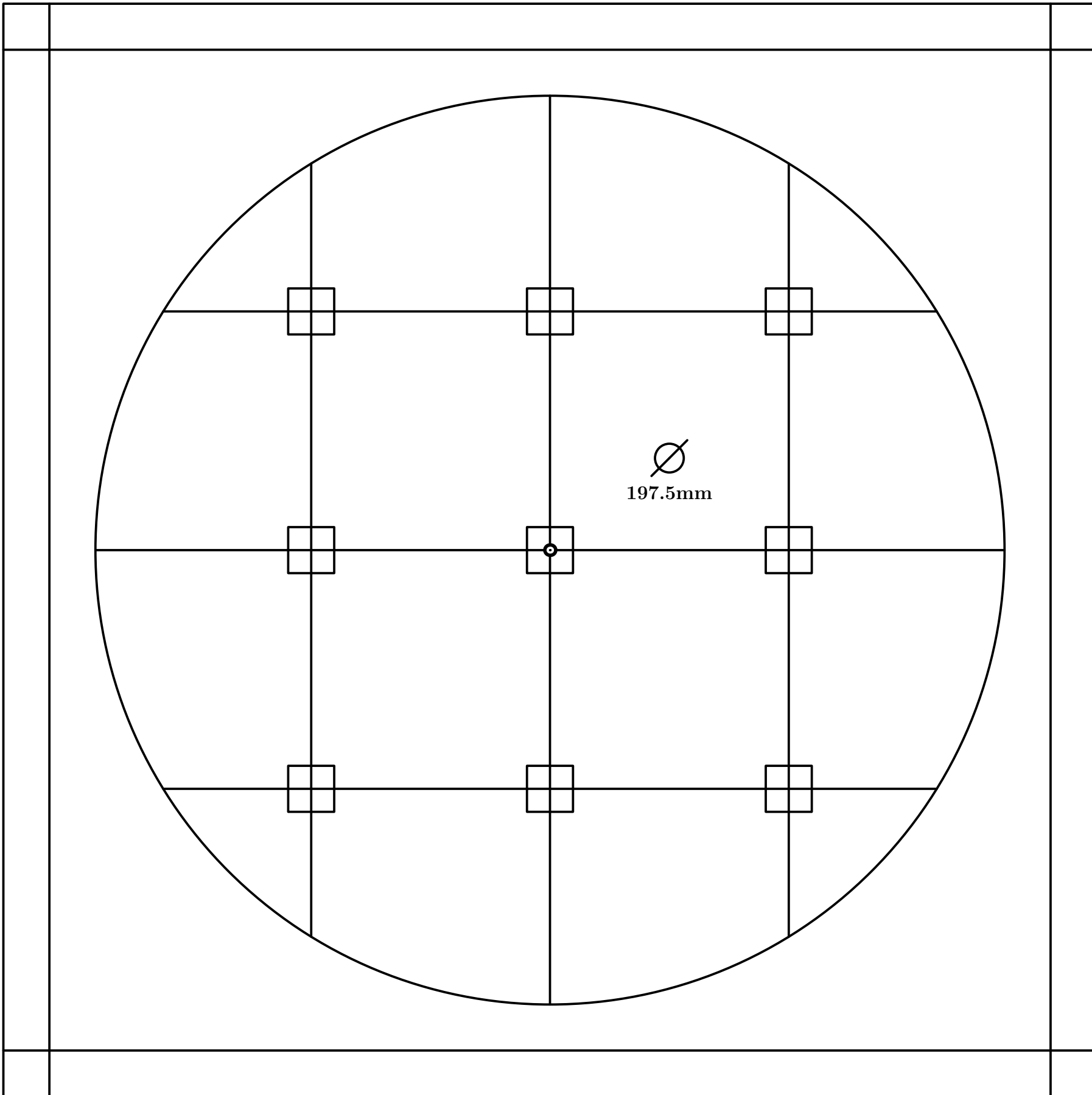

Fig. 391

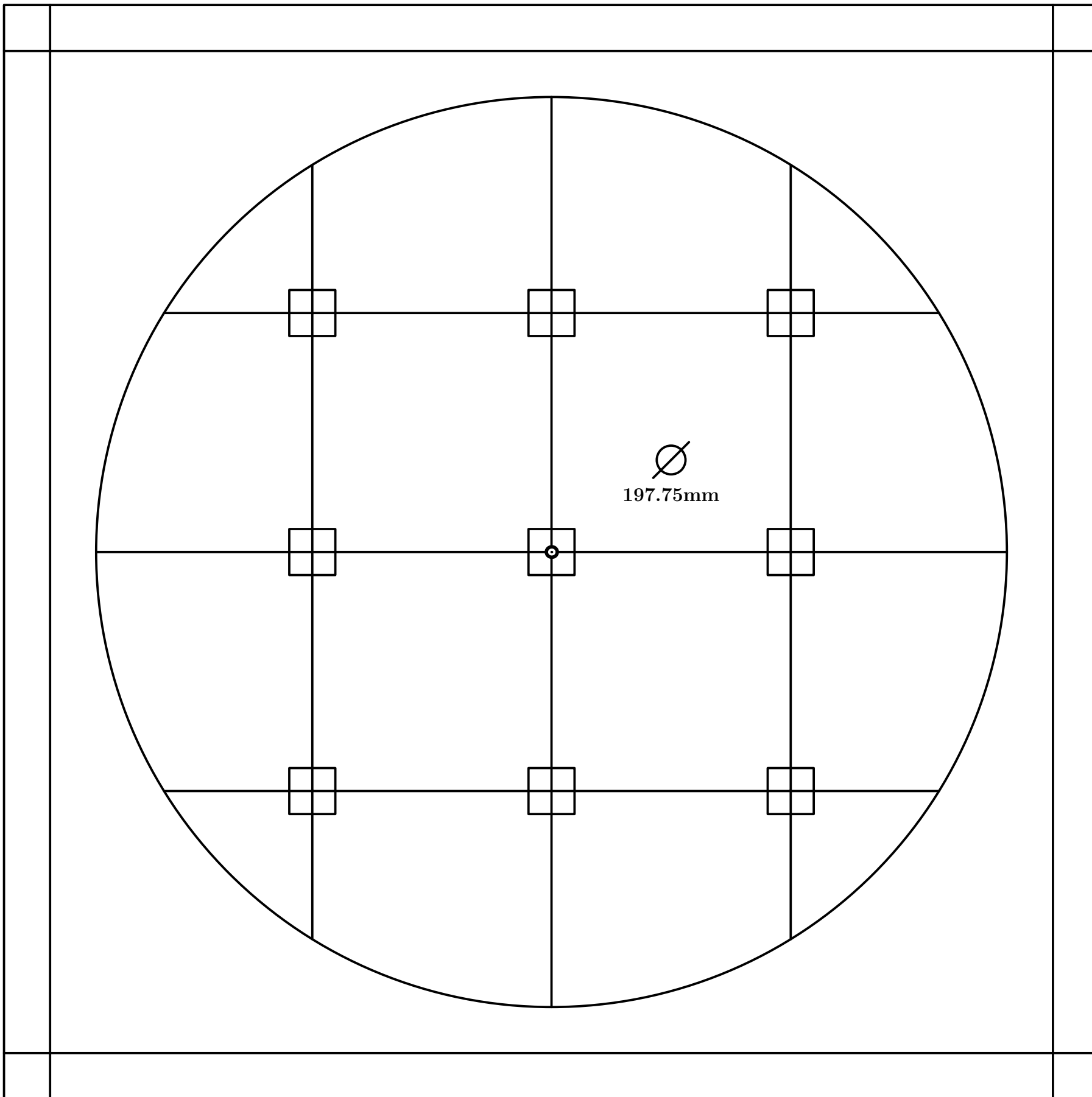

Fig. 392

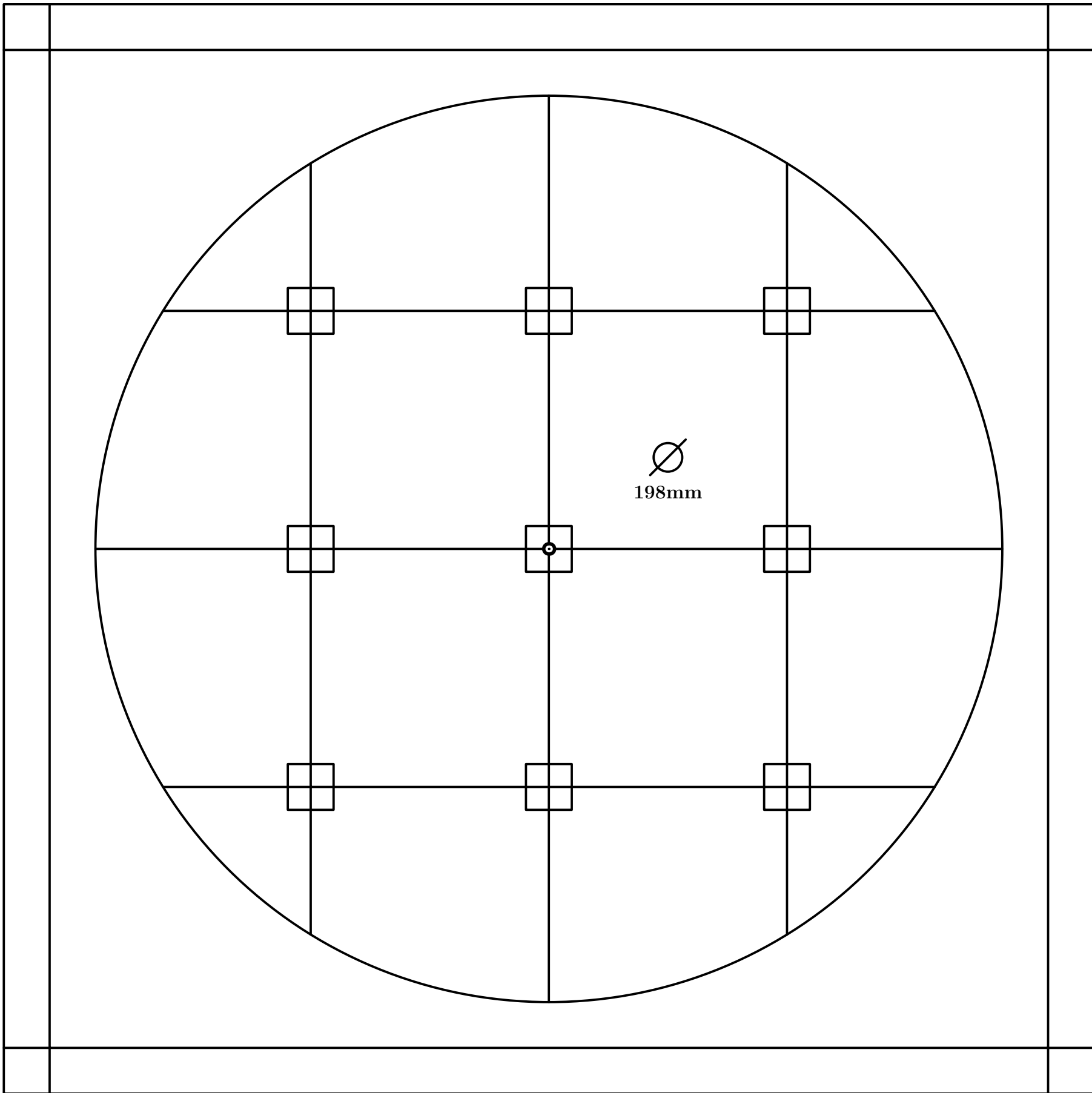

Fig. 393

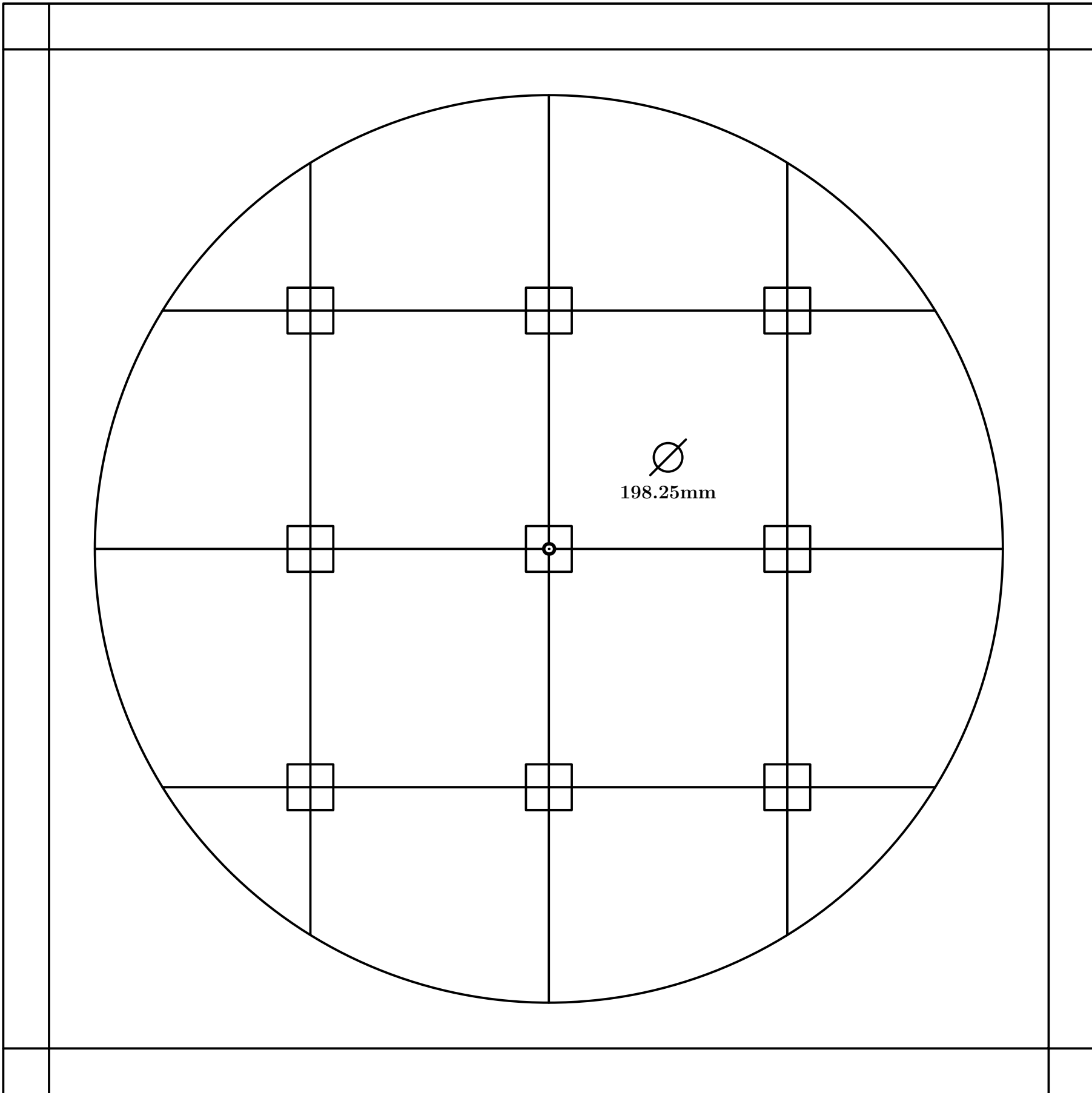

Fig. 394

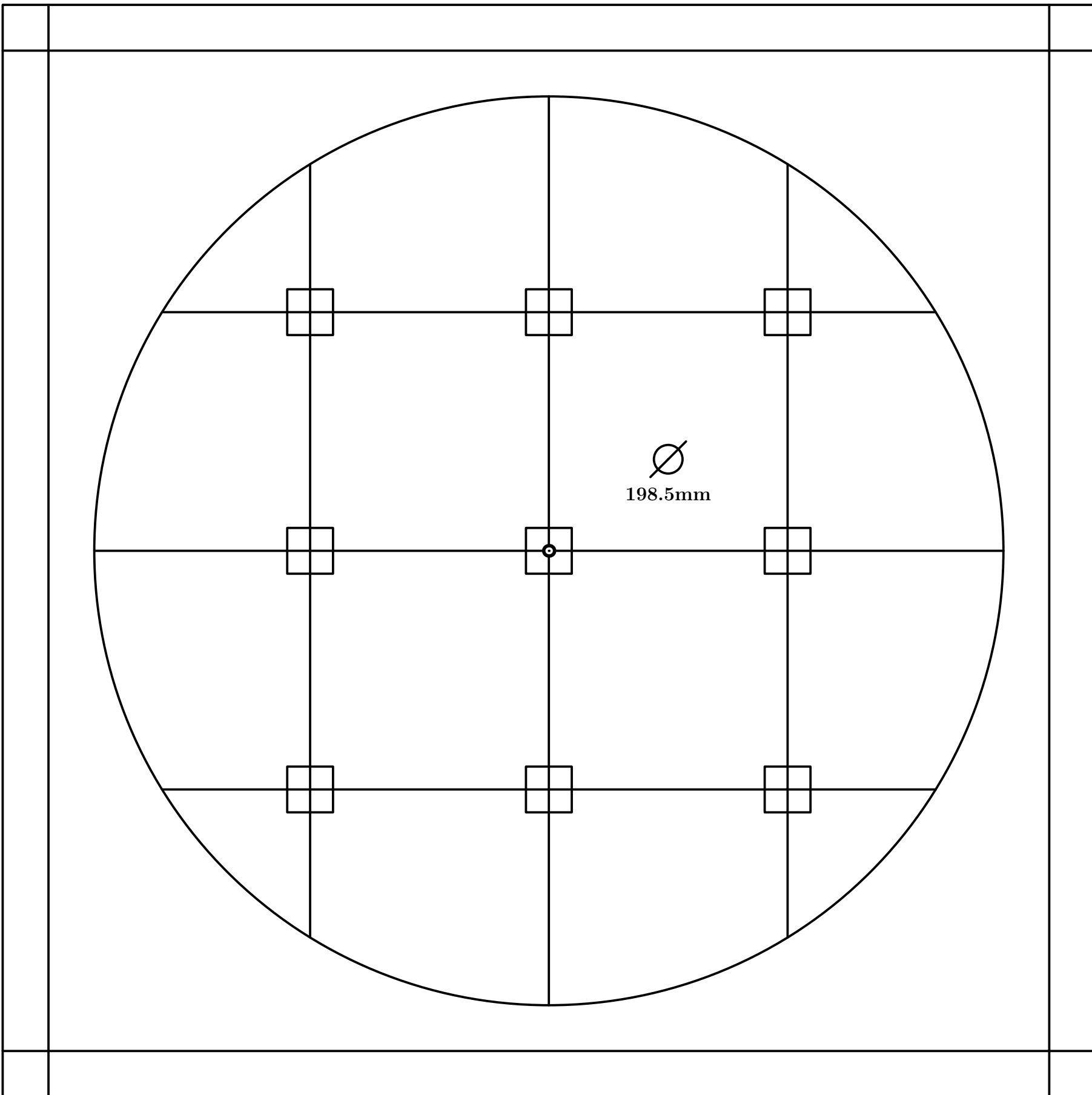

Fig. 395

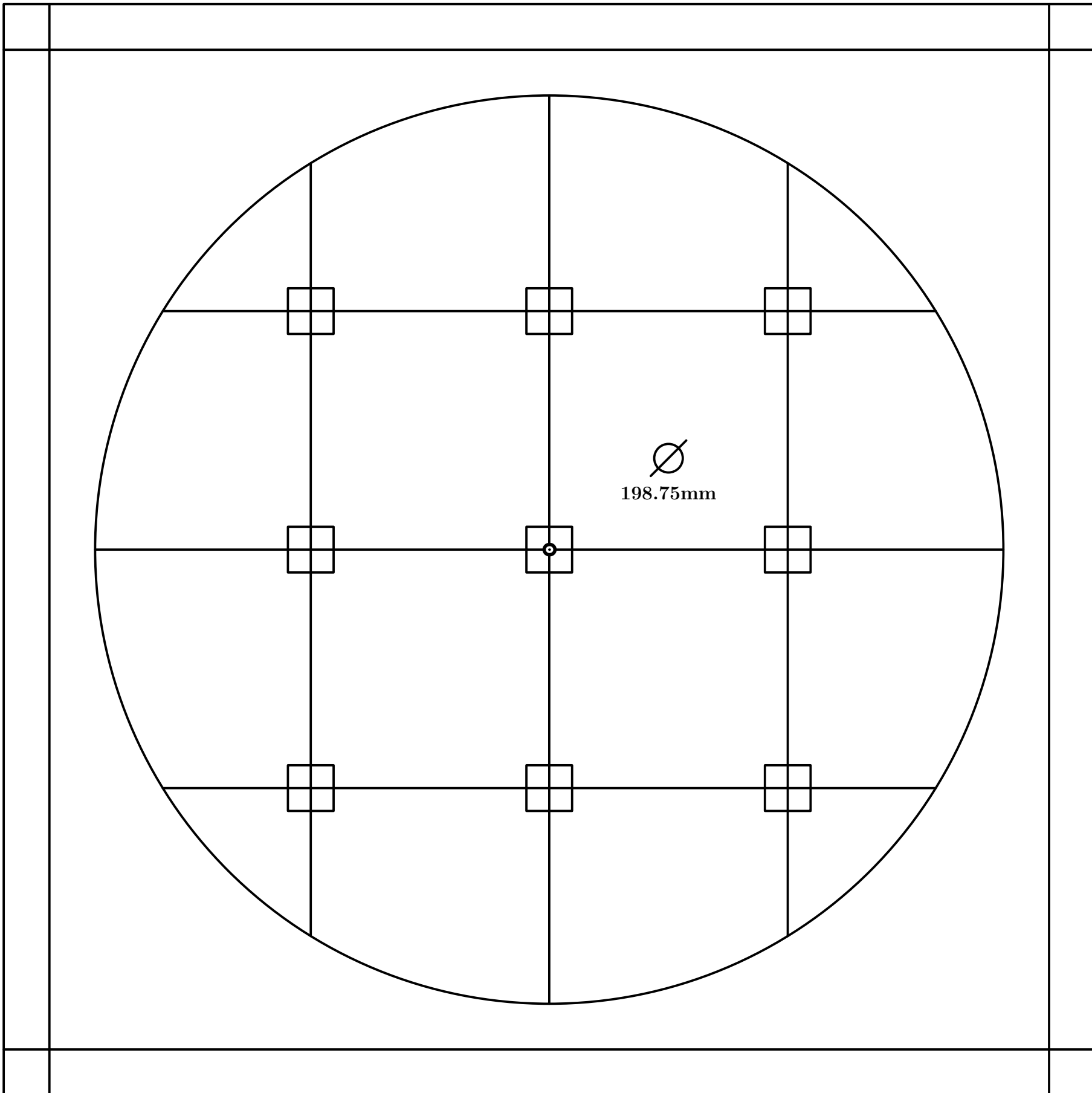

Fig. 396

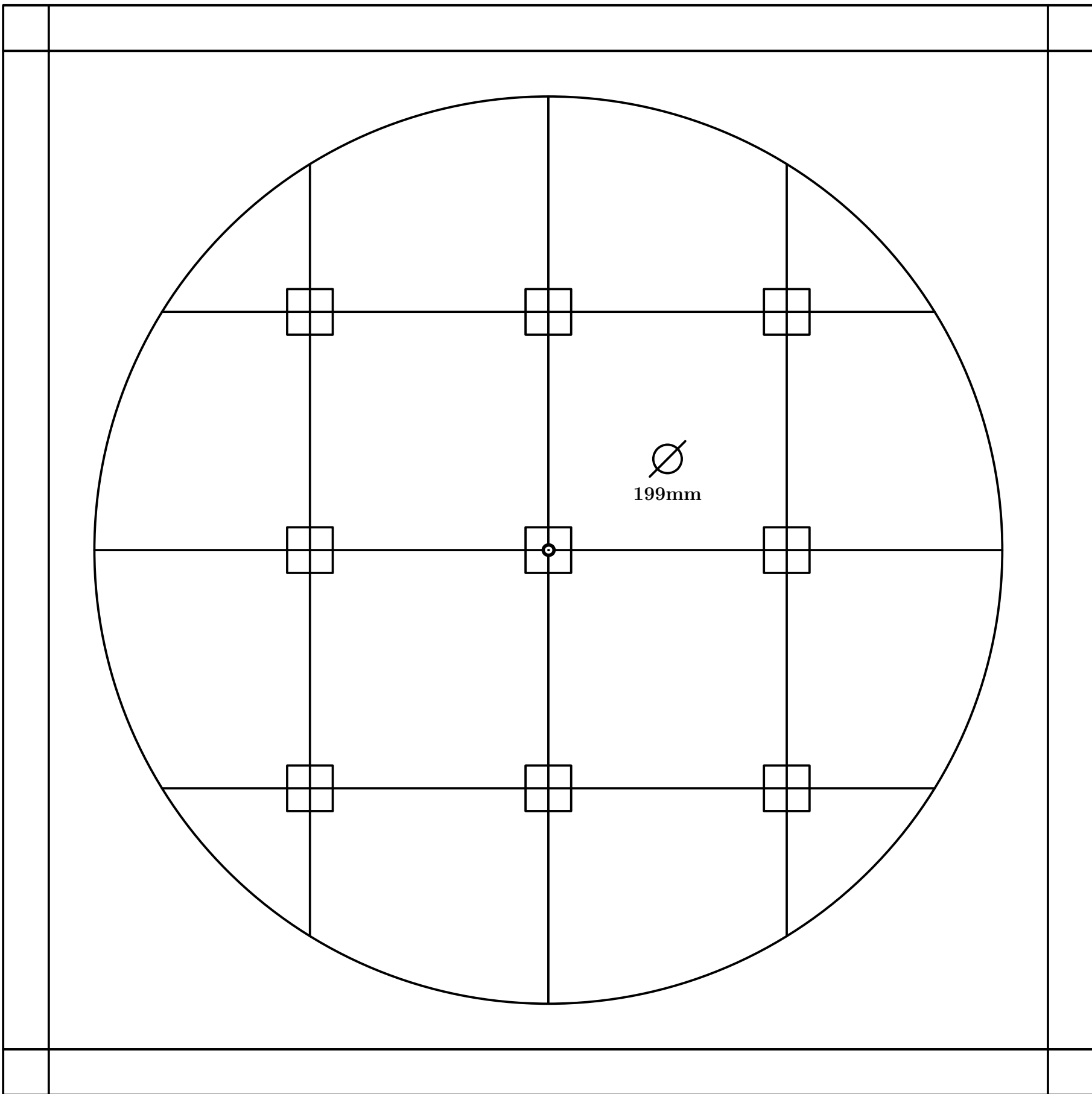

Fig. 397

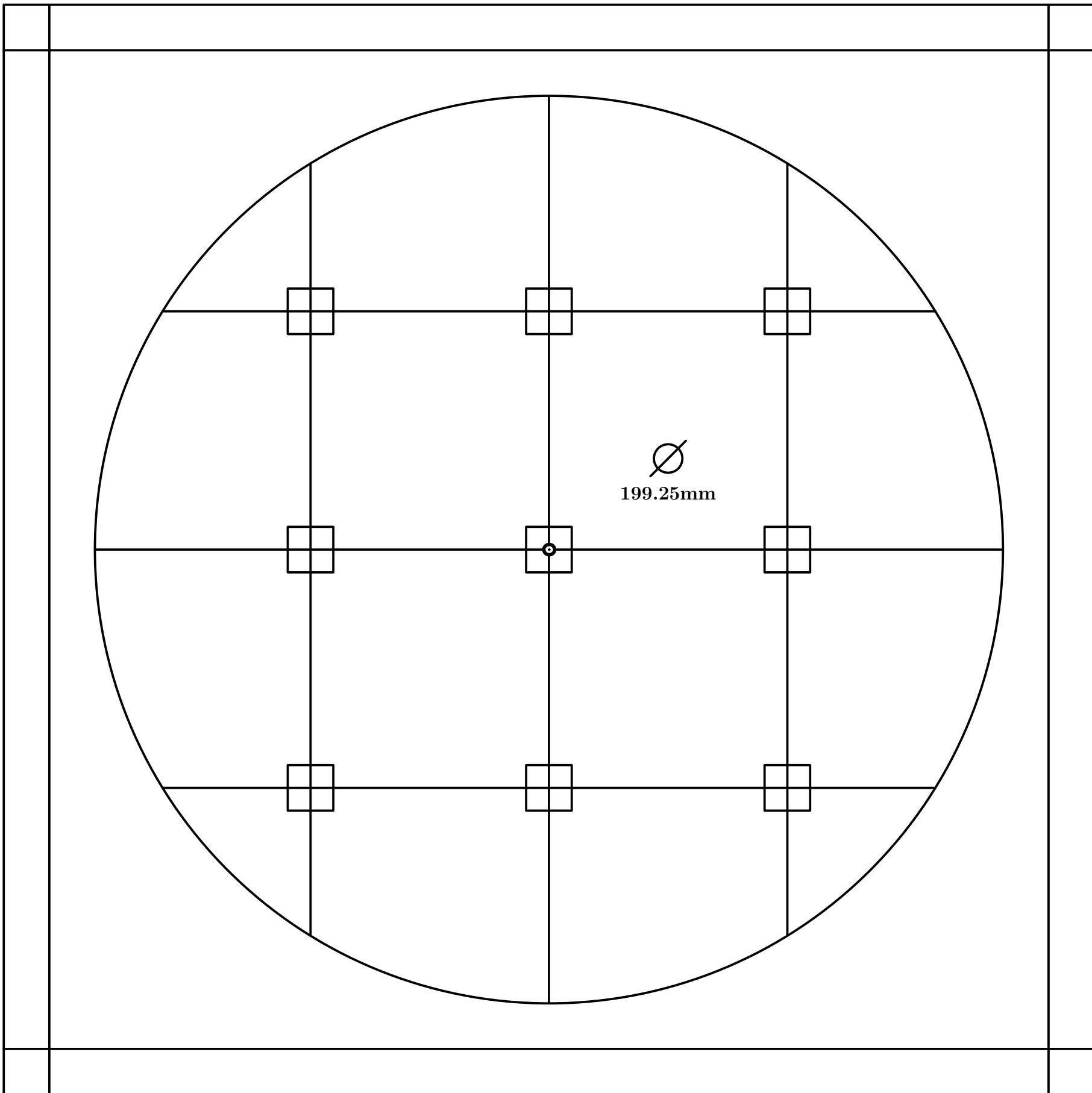

Fig. 398

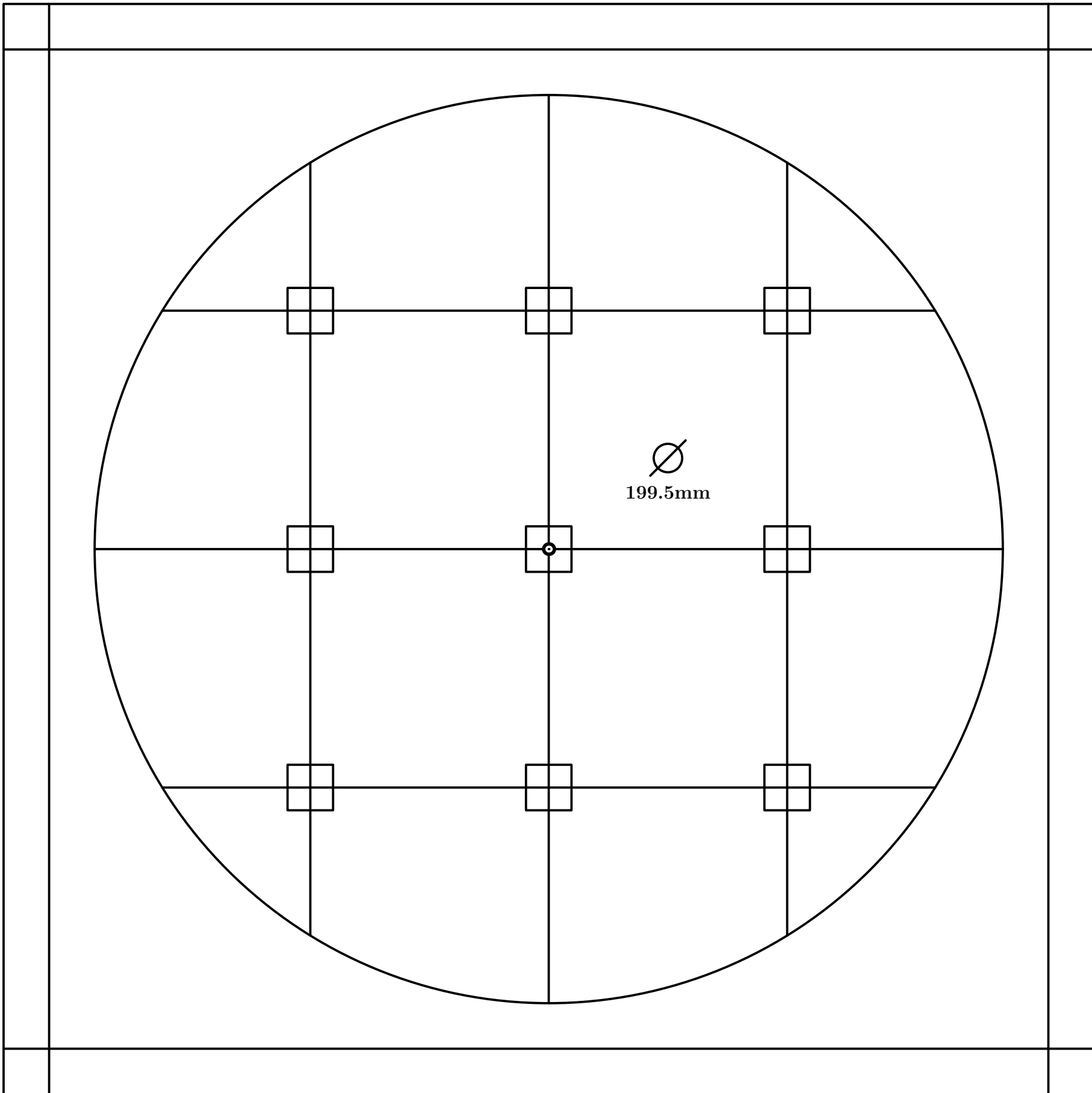

Fig. 399

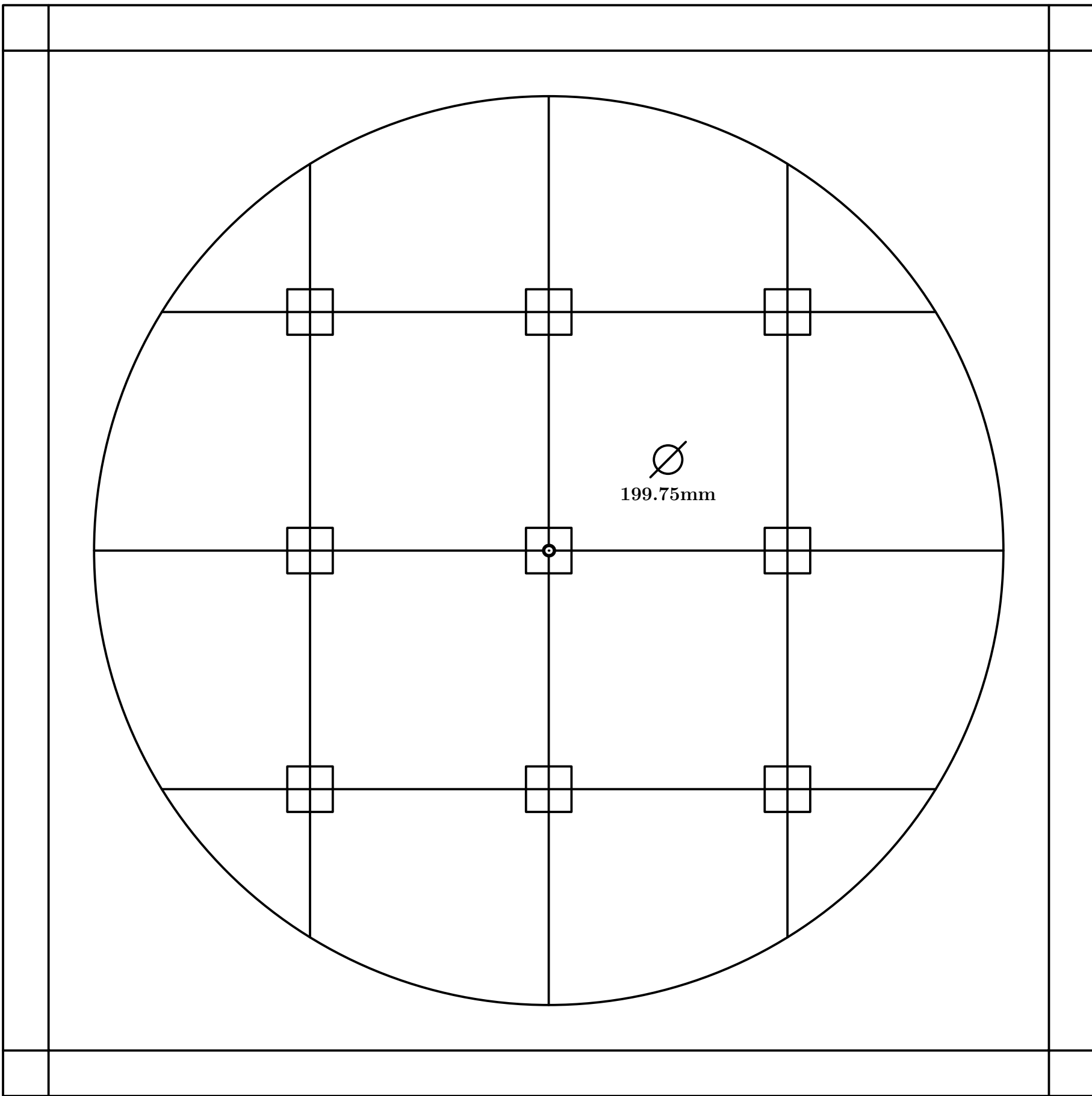

Fig. 400

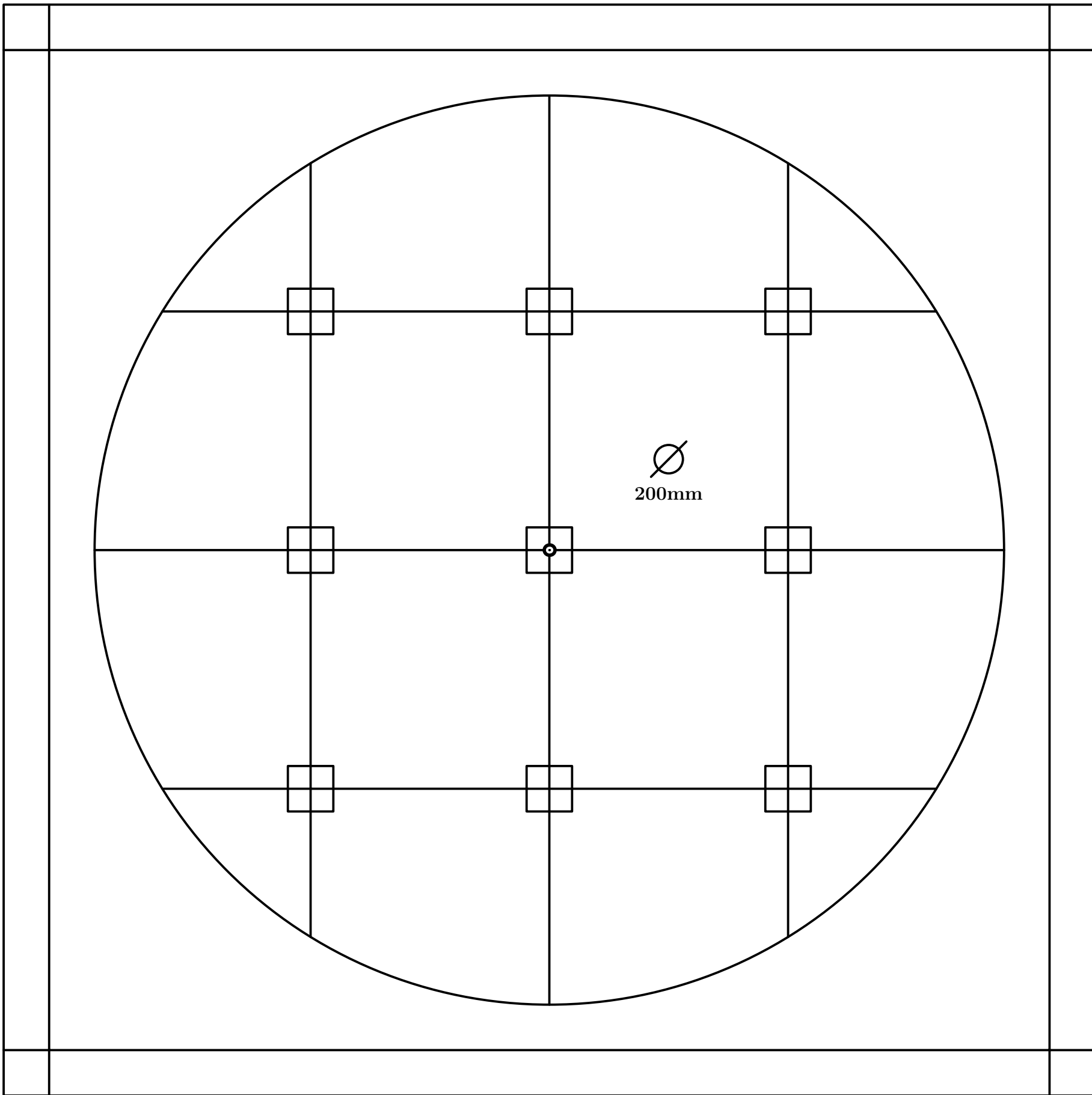

Fig. 401

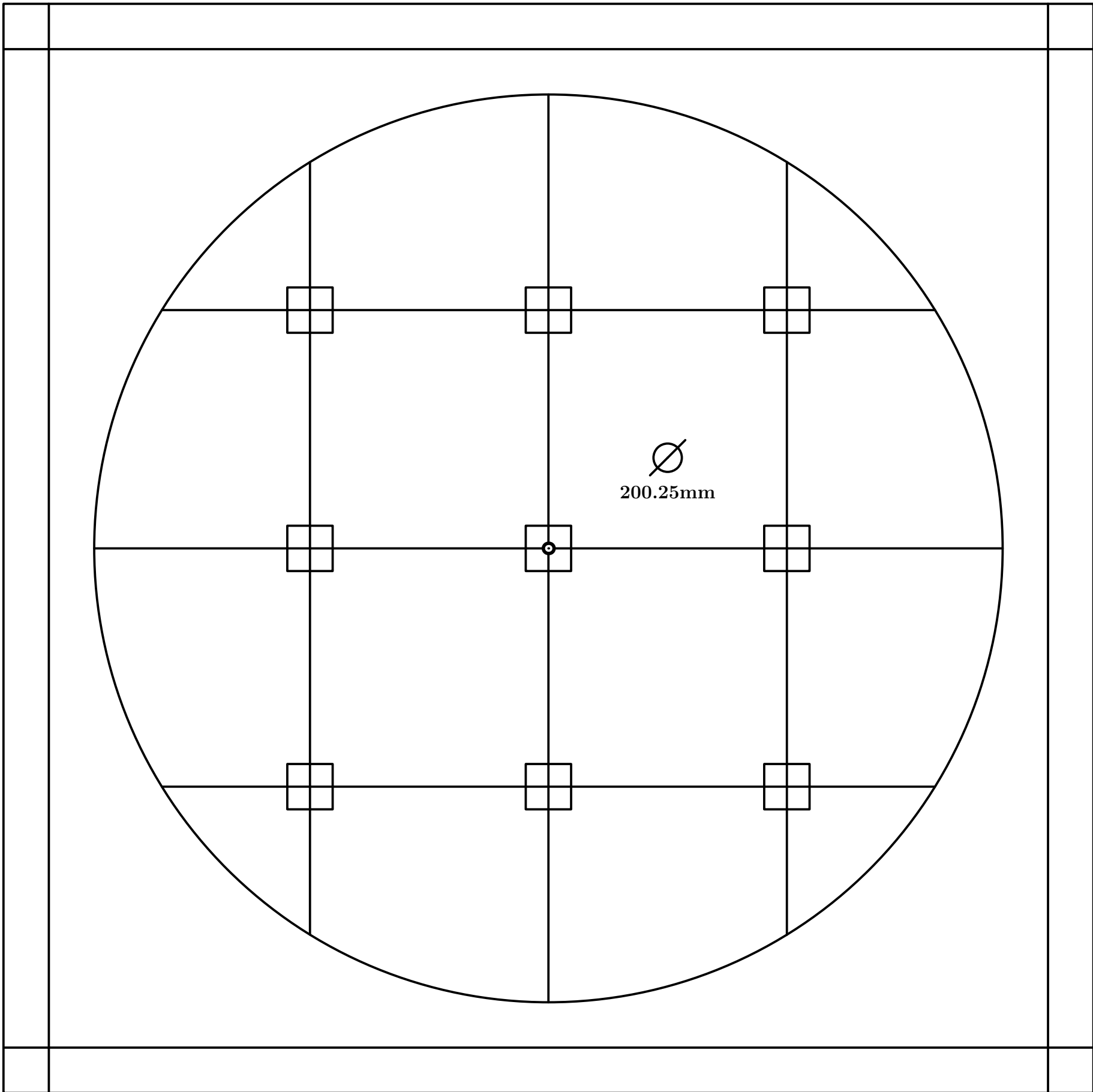

Fig. 402

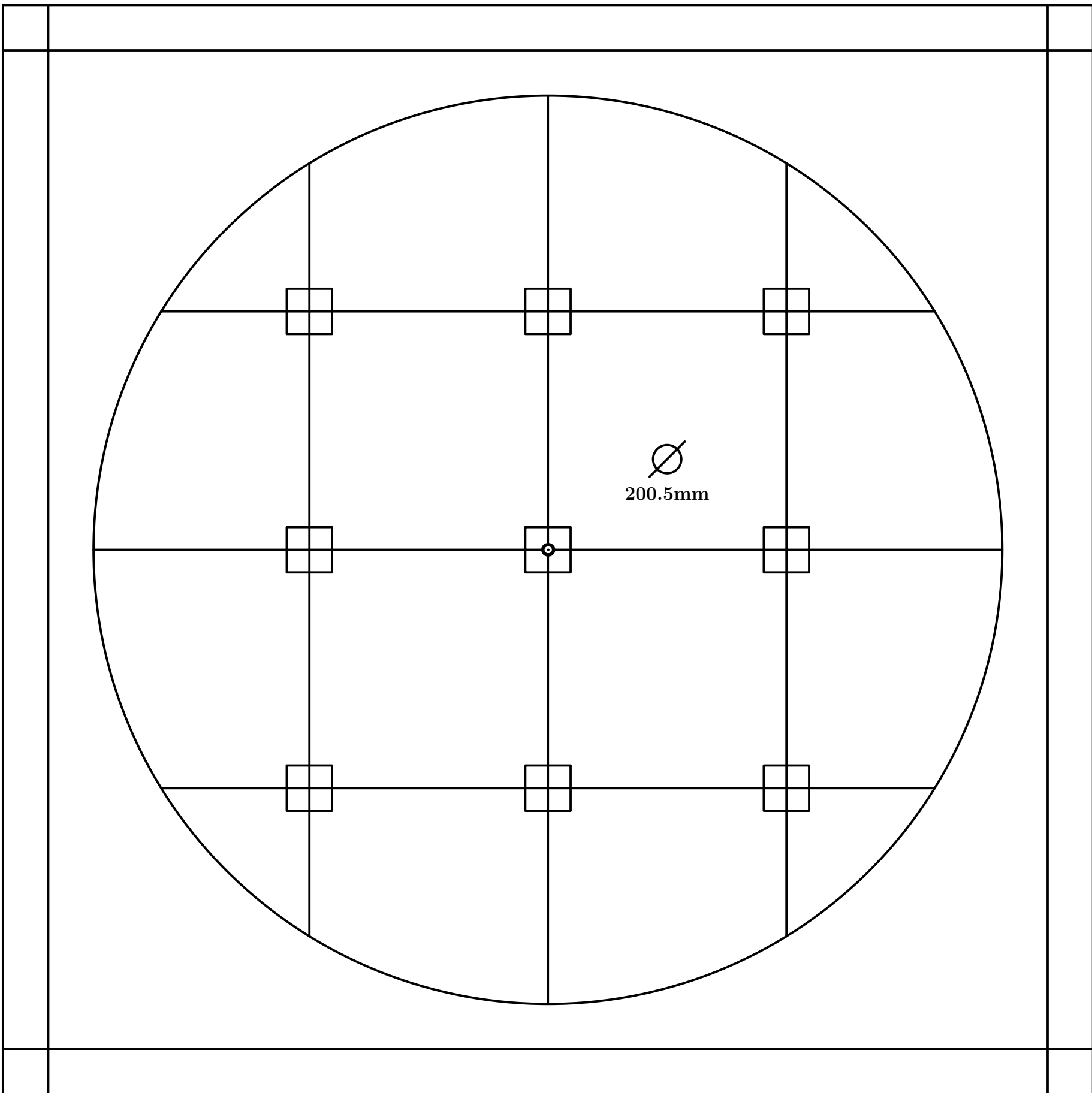

Fig. 403

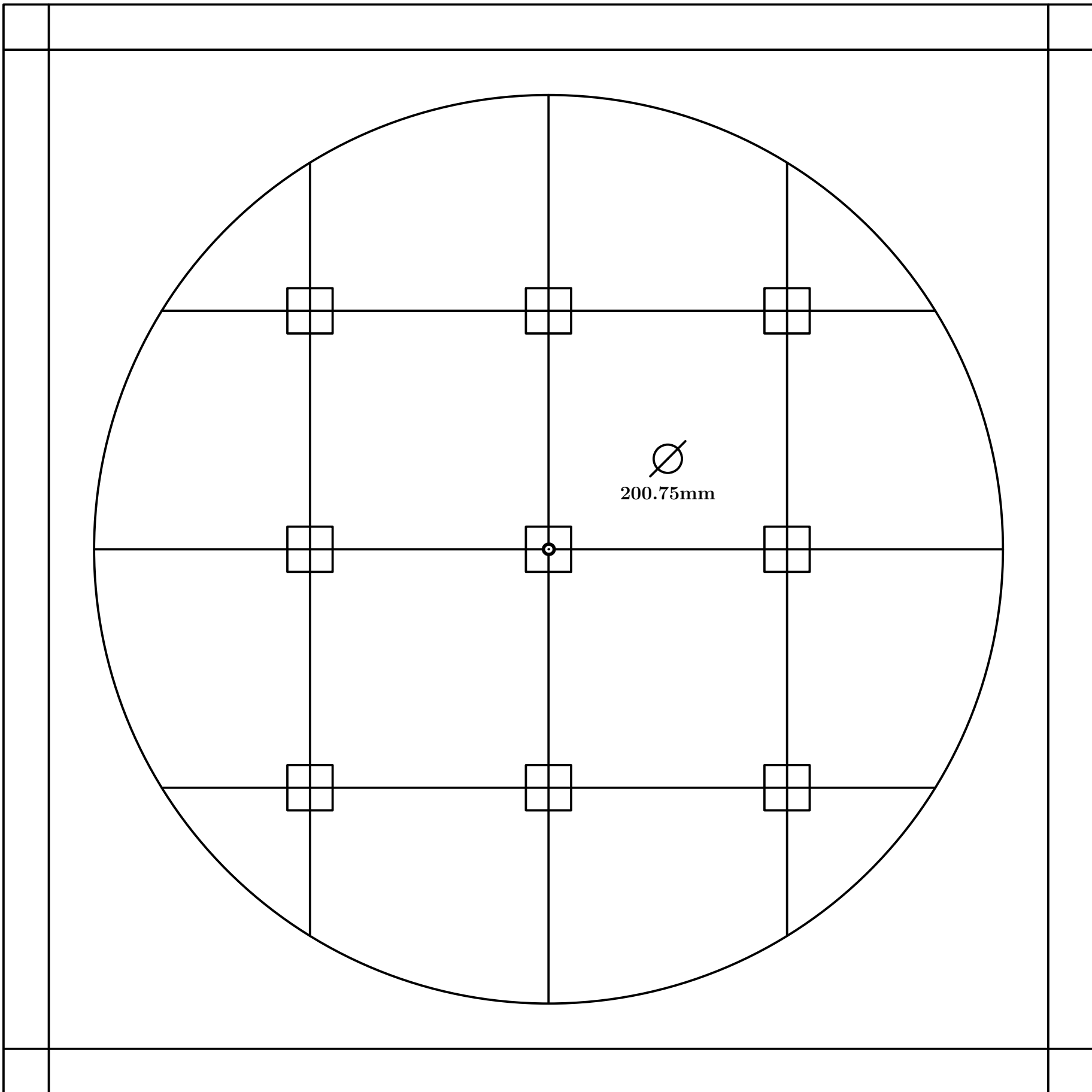

Fig. 404

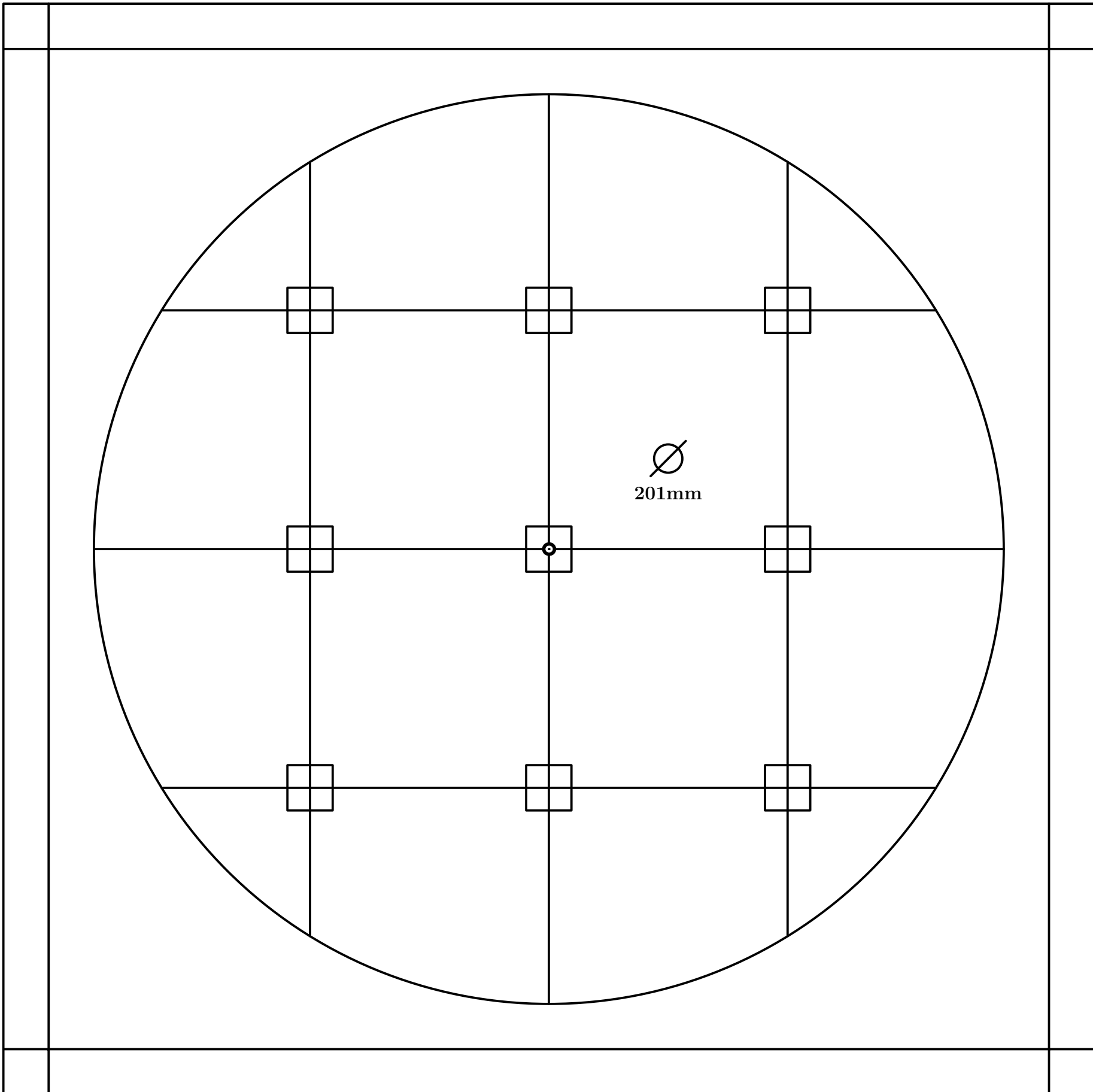

Fig. 405

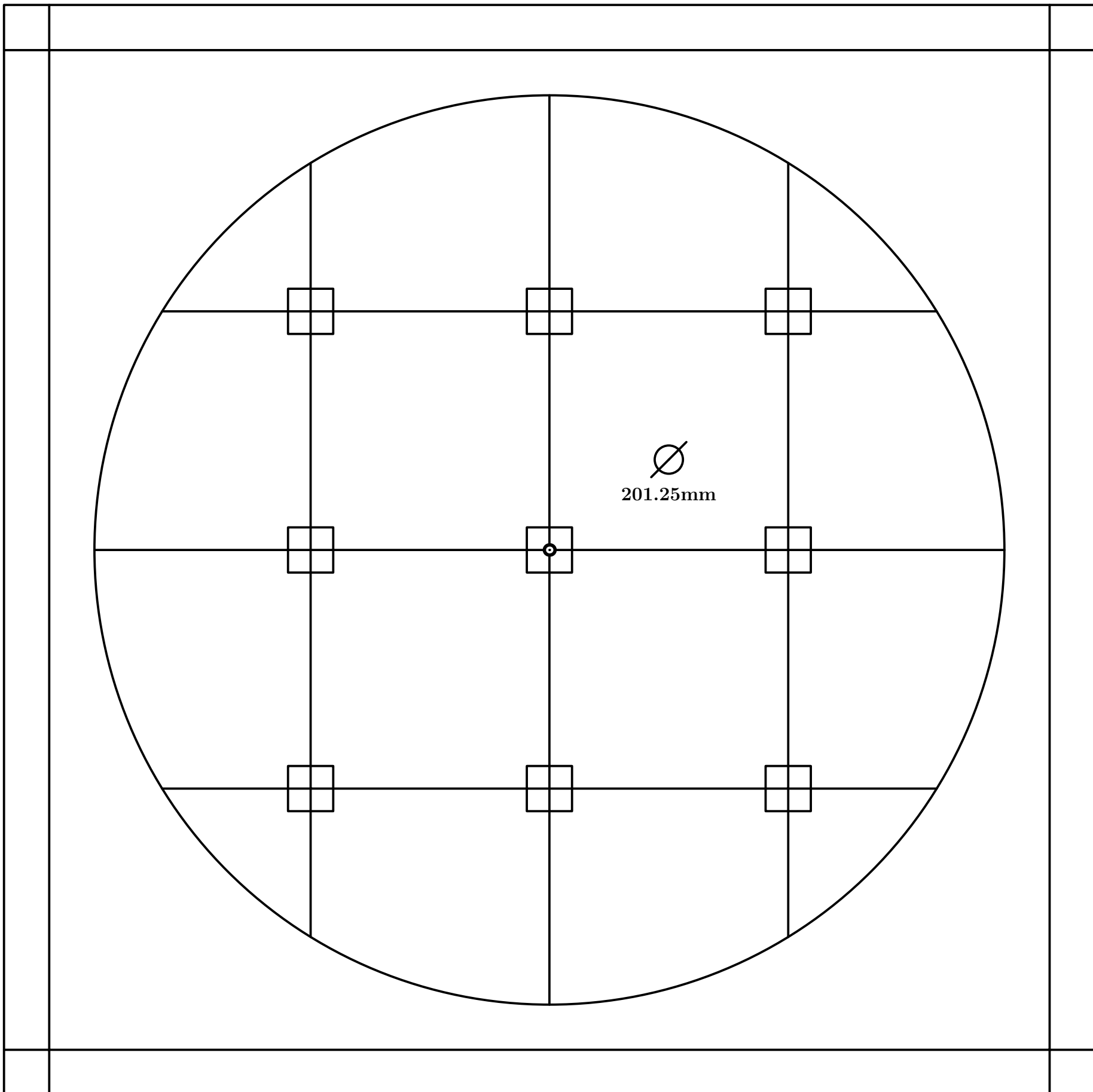

Fig. 406

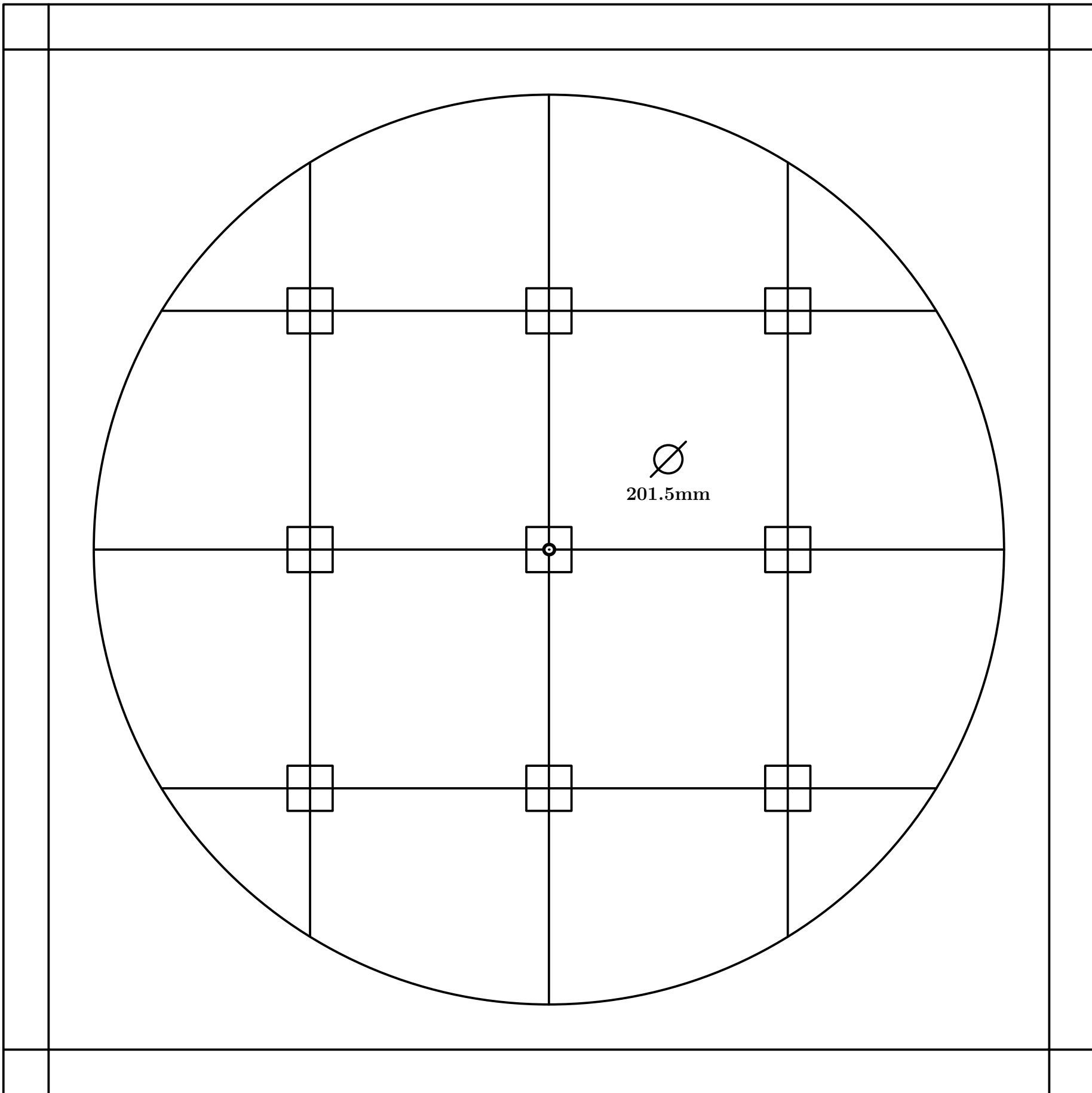

Fig. 407

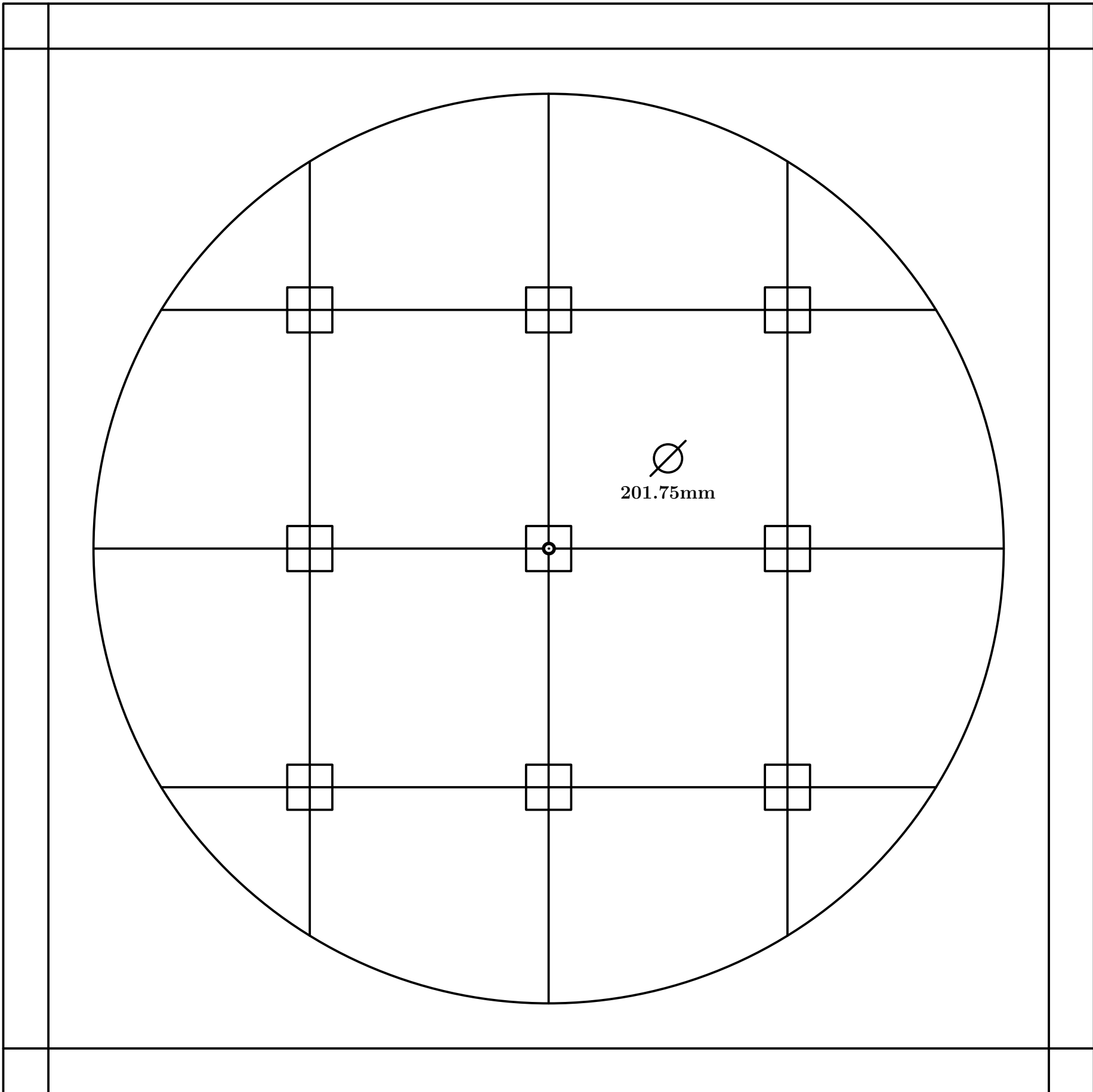

Fig. 408

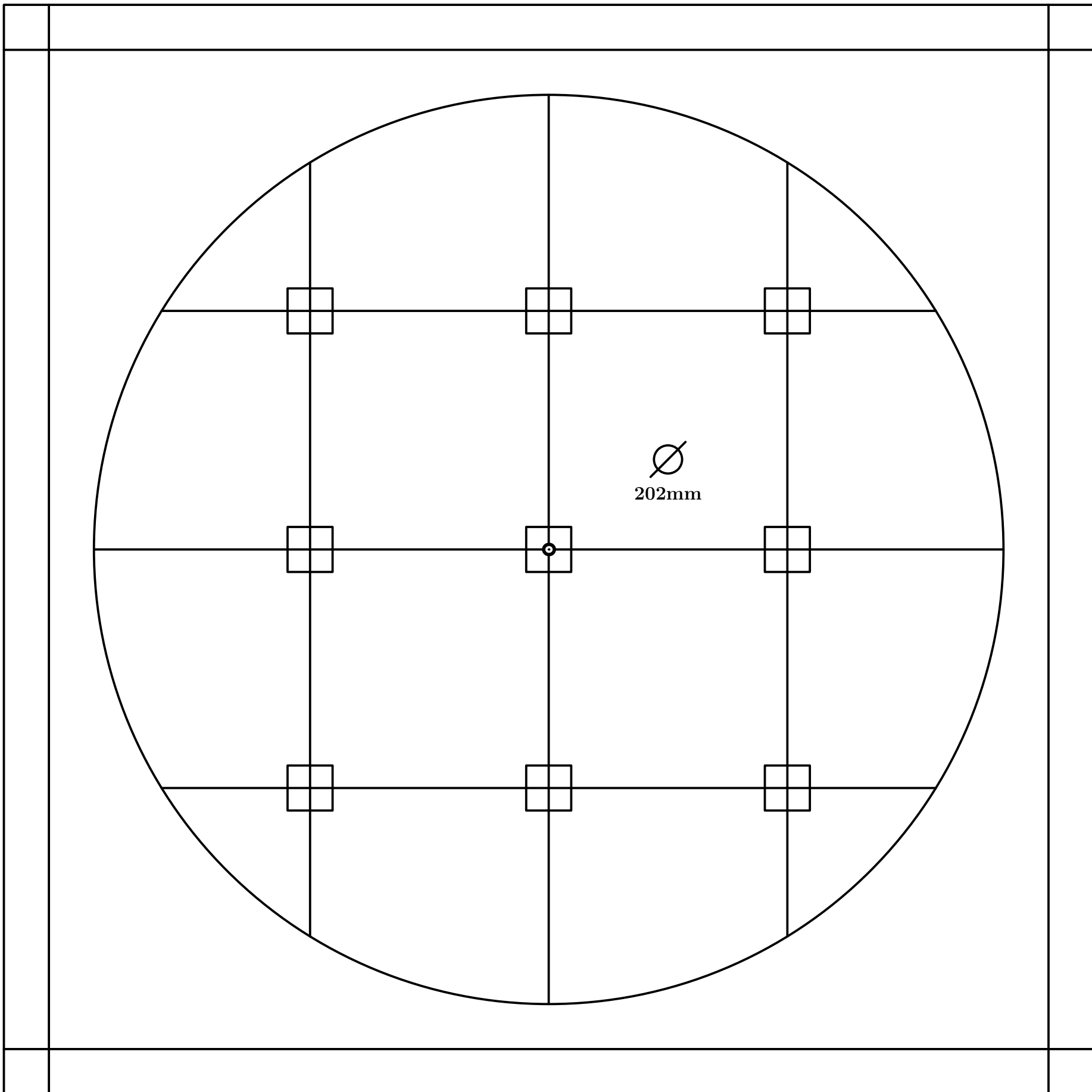

Fig. 409

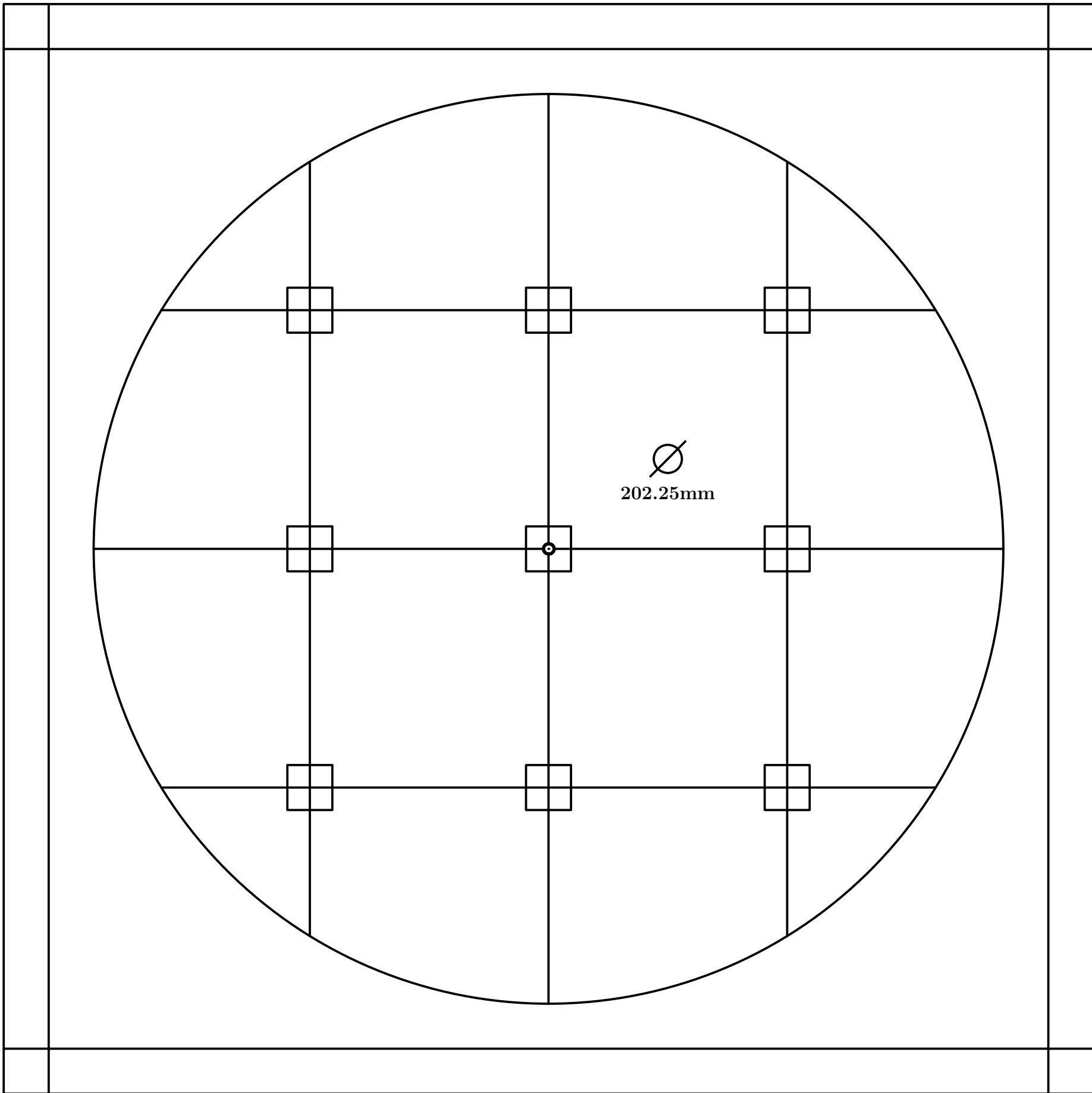

Fig. 410

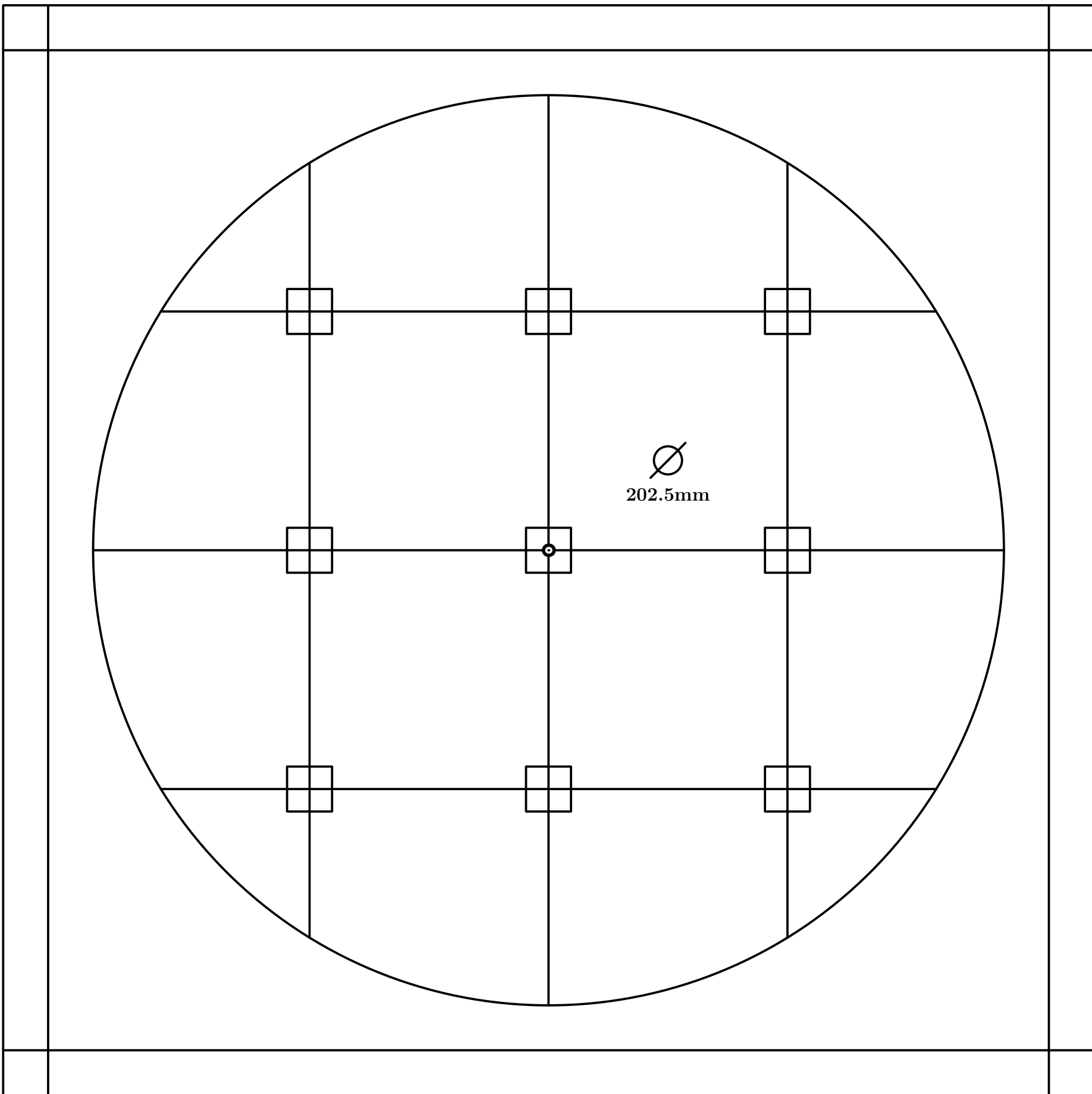

Fig. 411

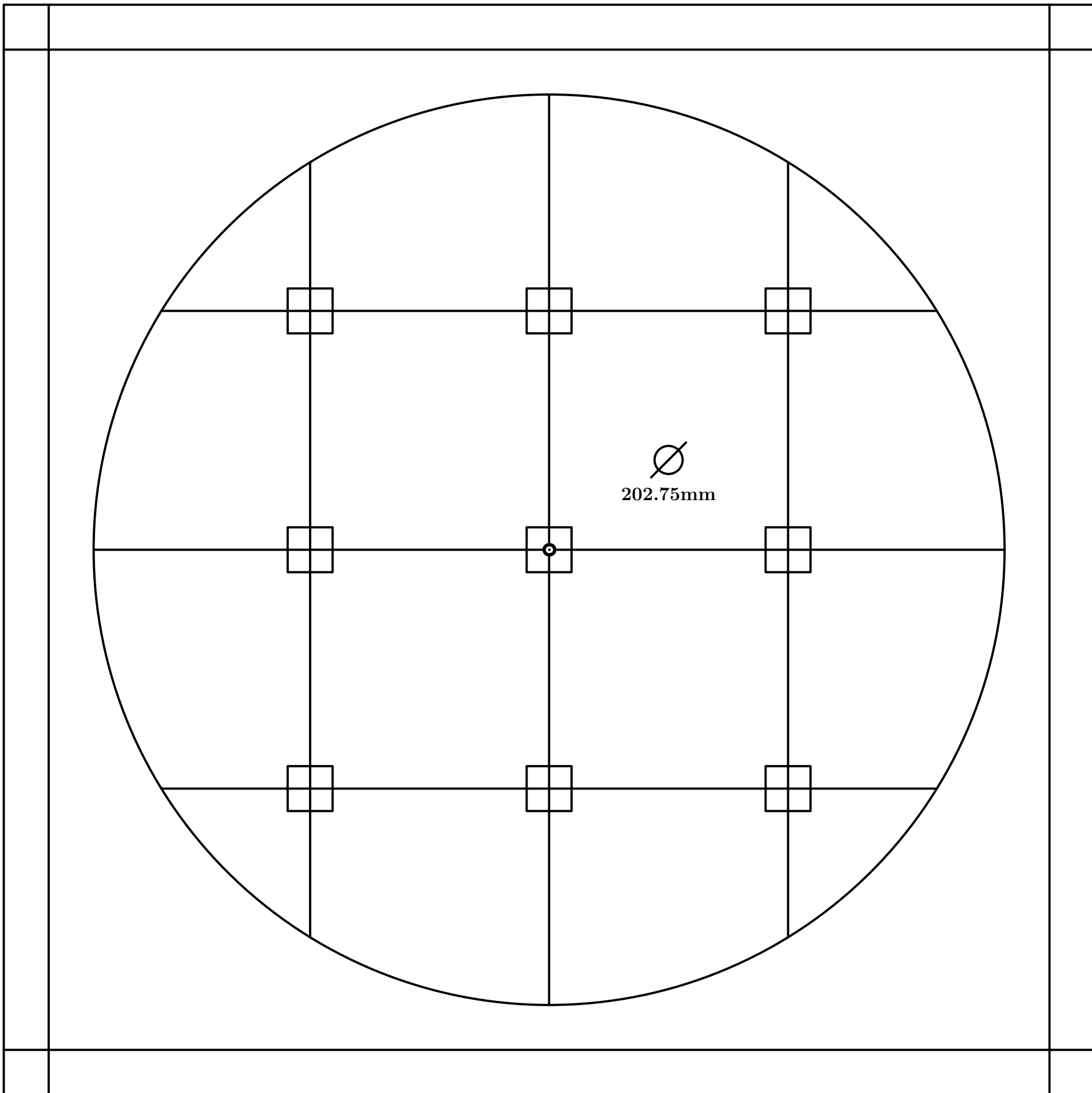

Fig. 412

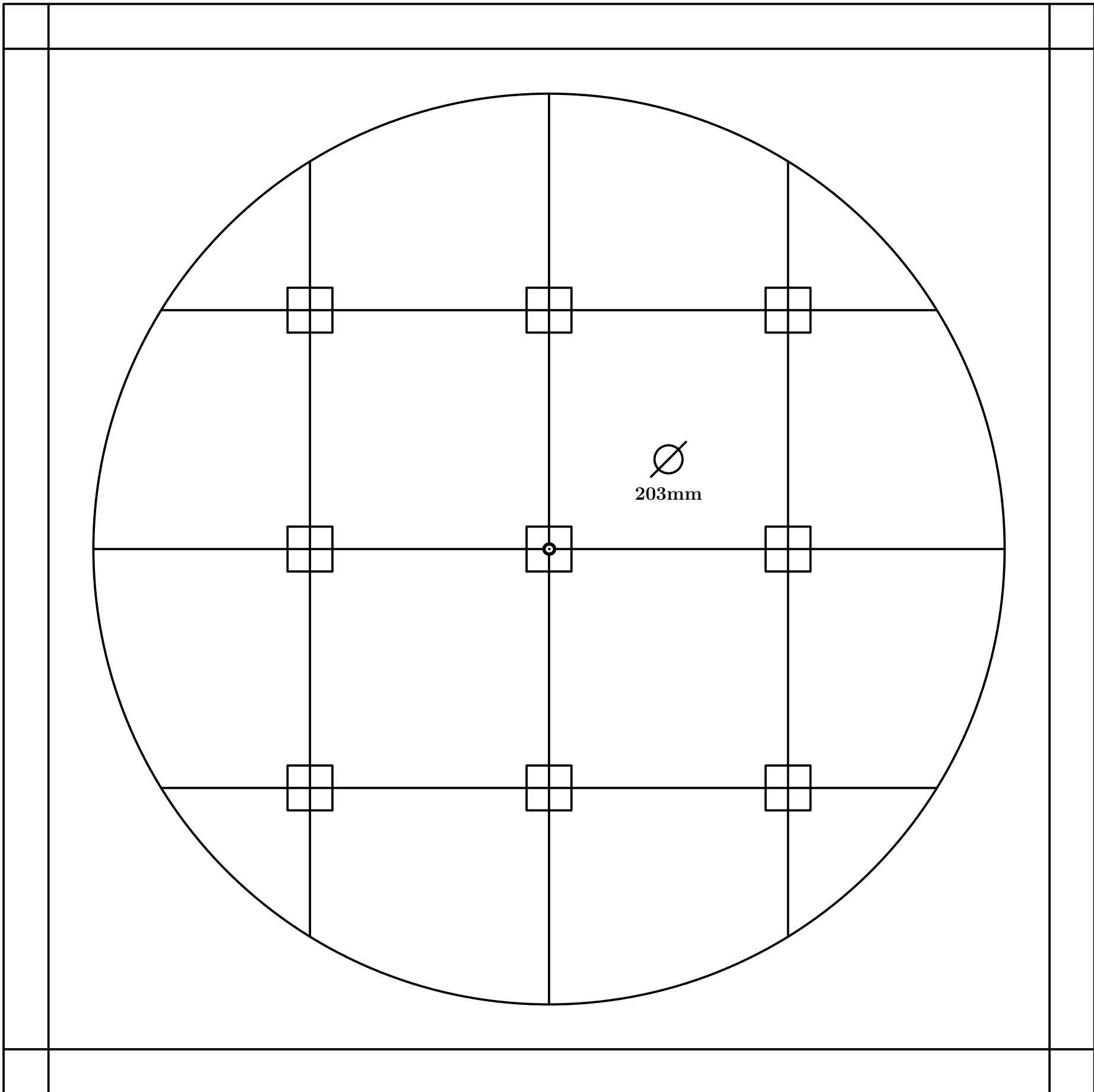

Fig. 413

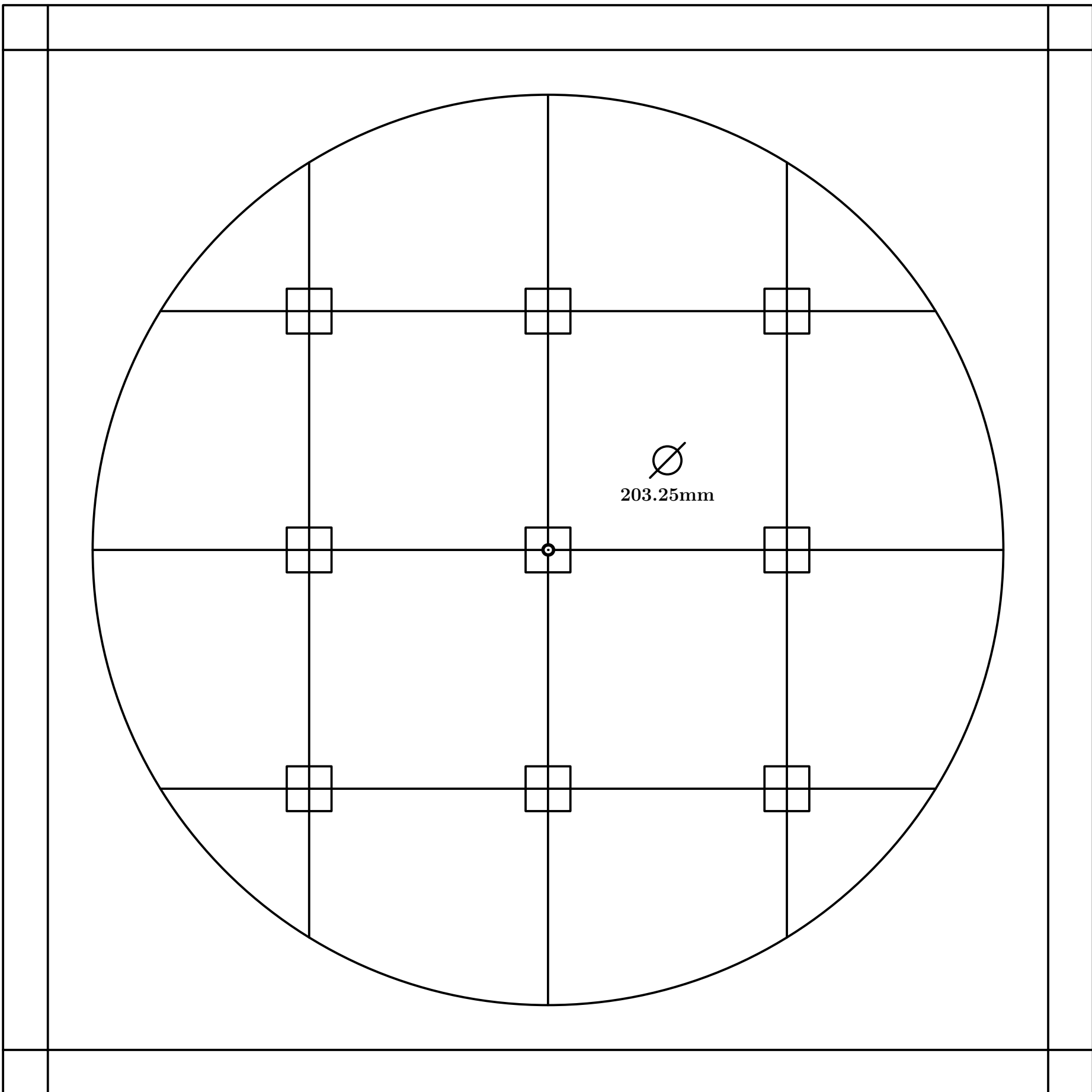

Fig. 414

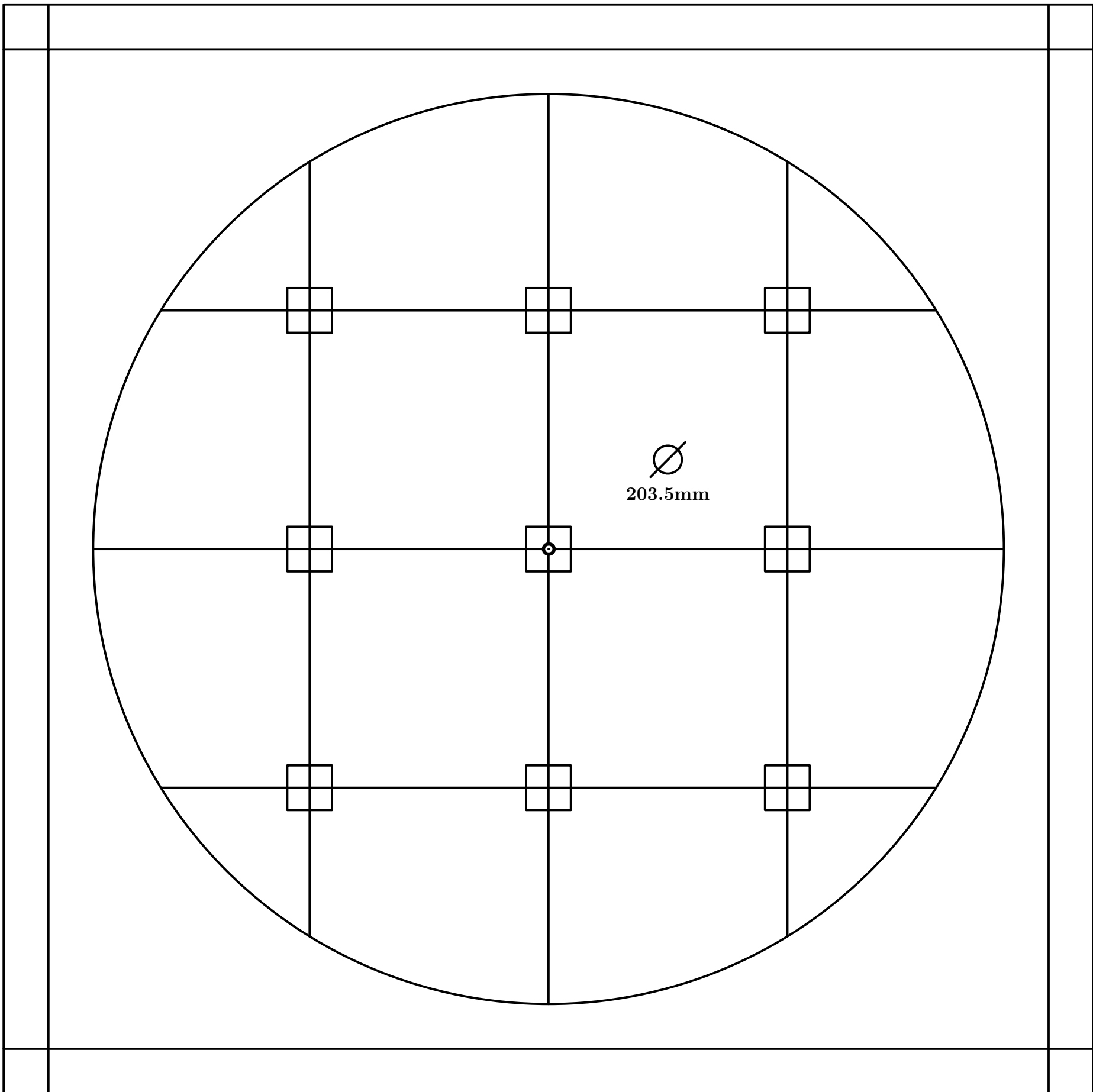

Fig. 415

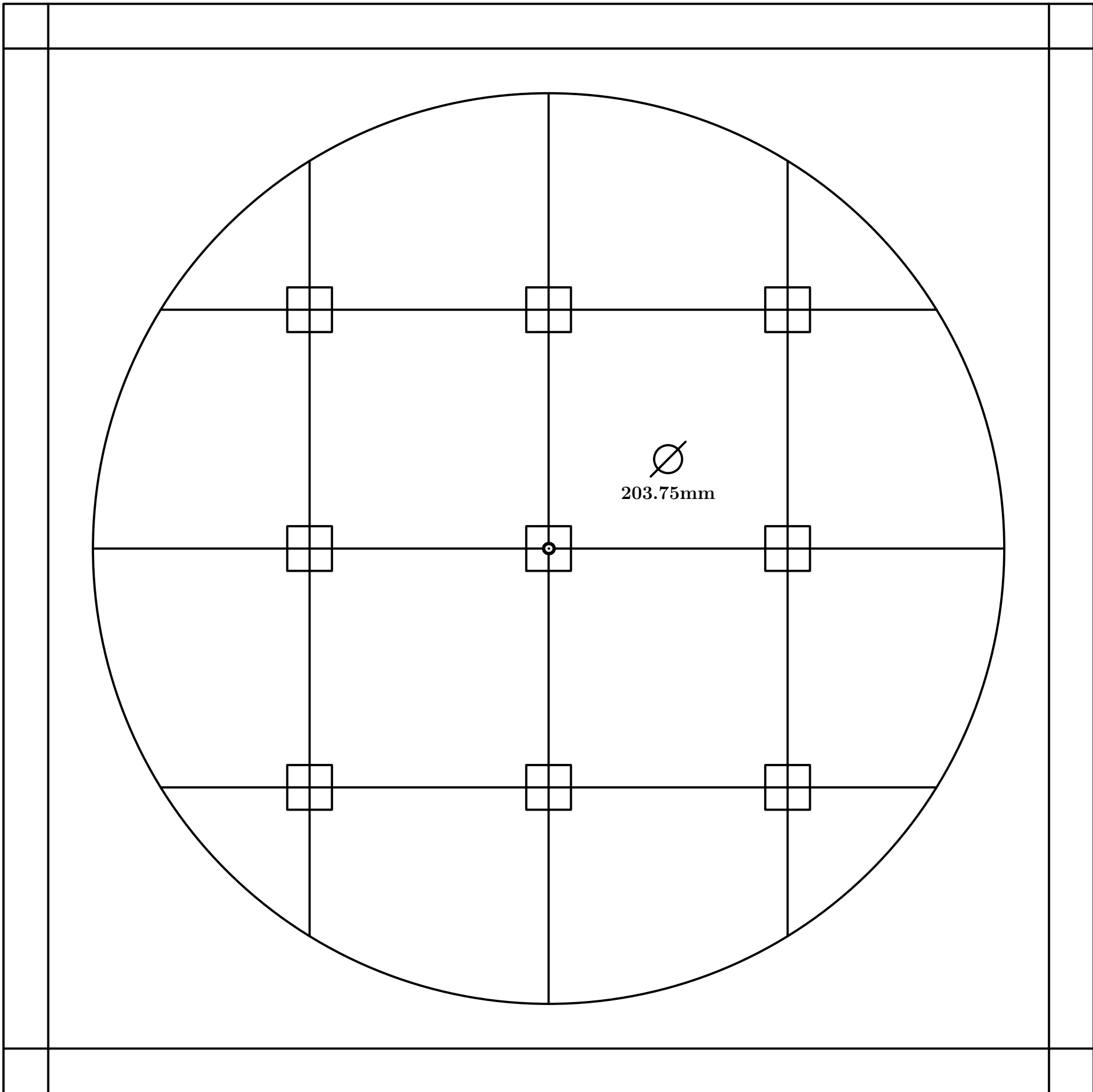

Fig. 416

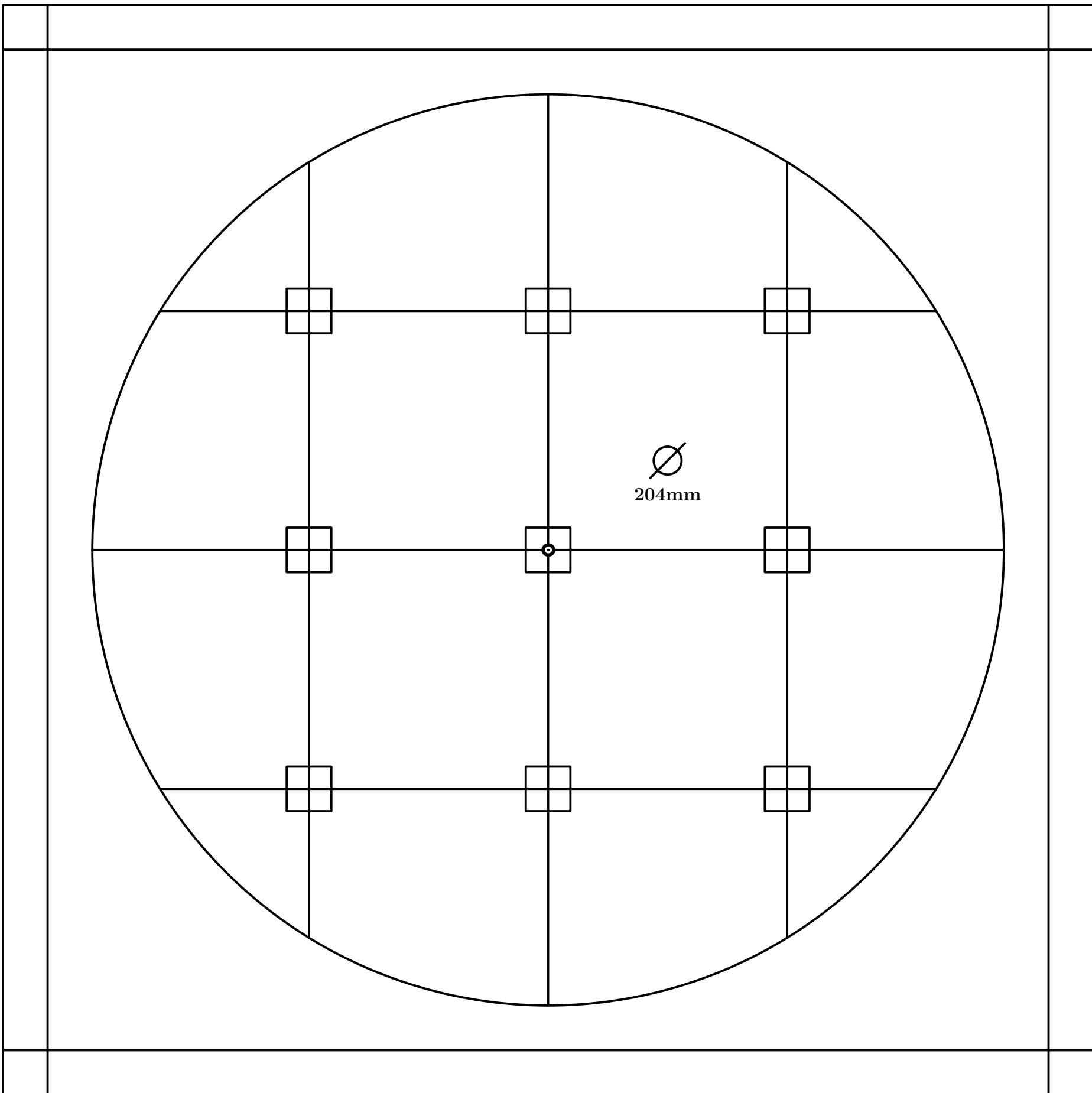

Fig. 417

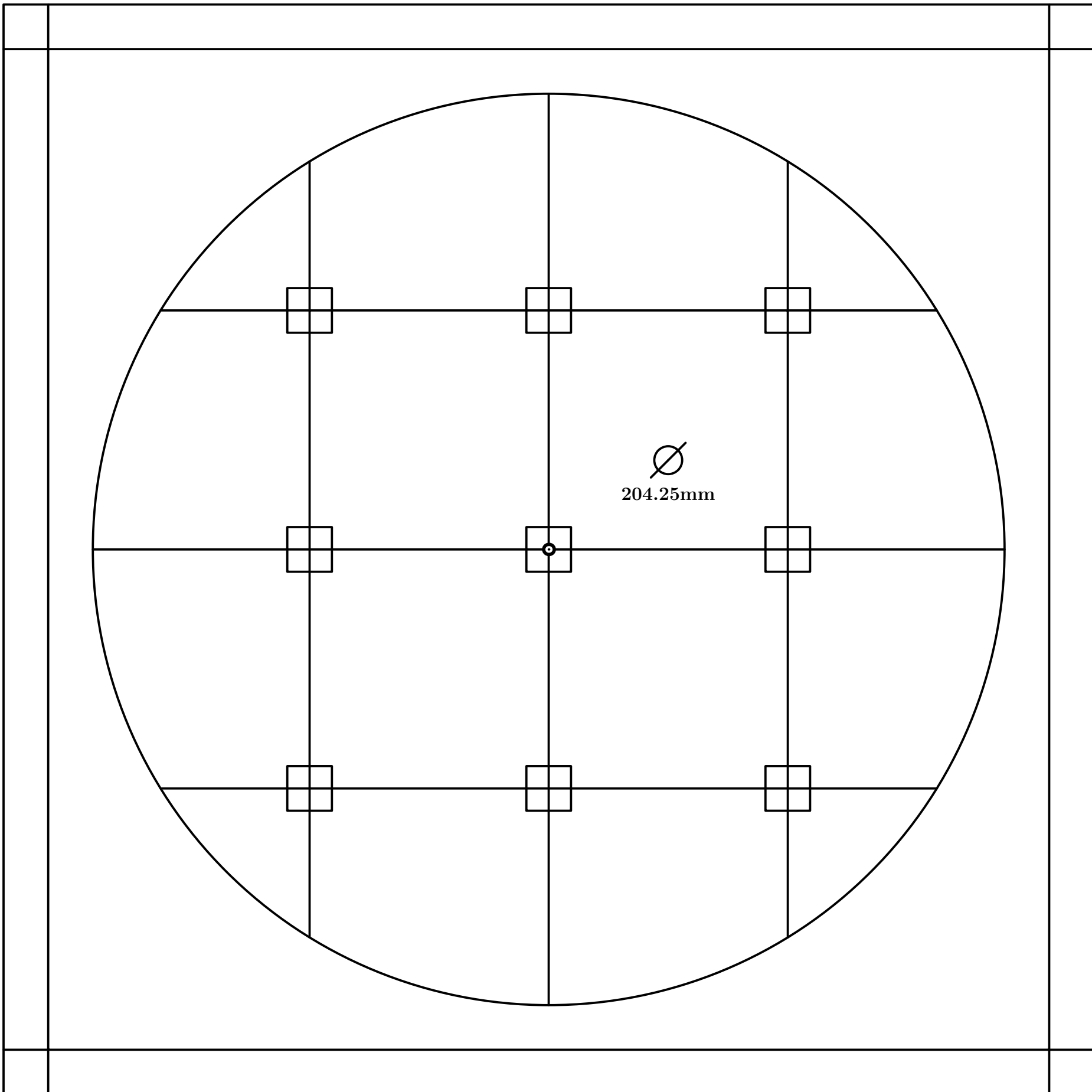

Fig. 418

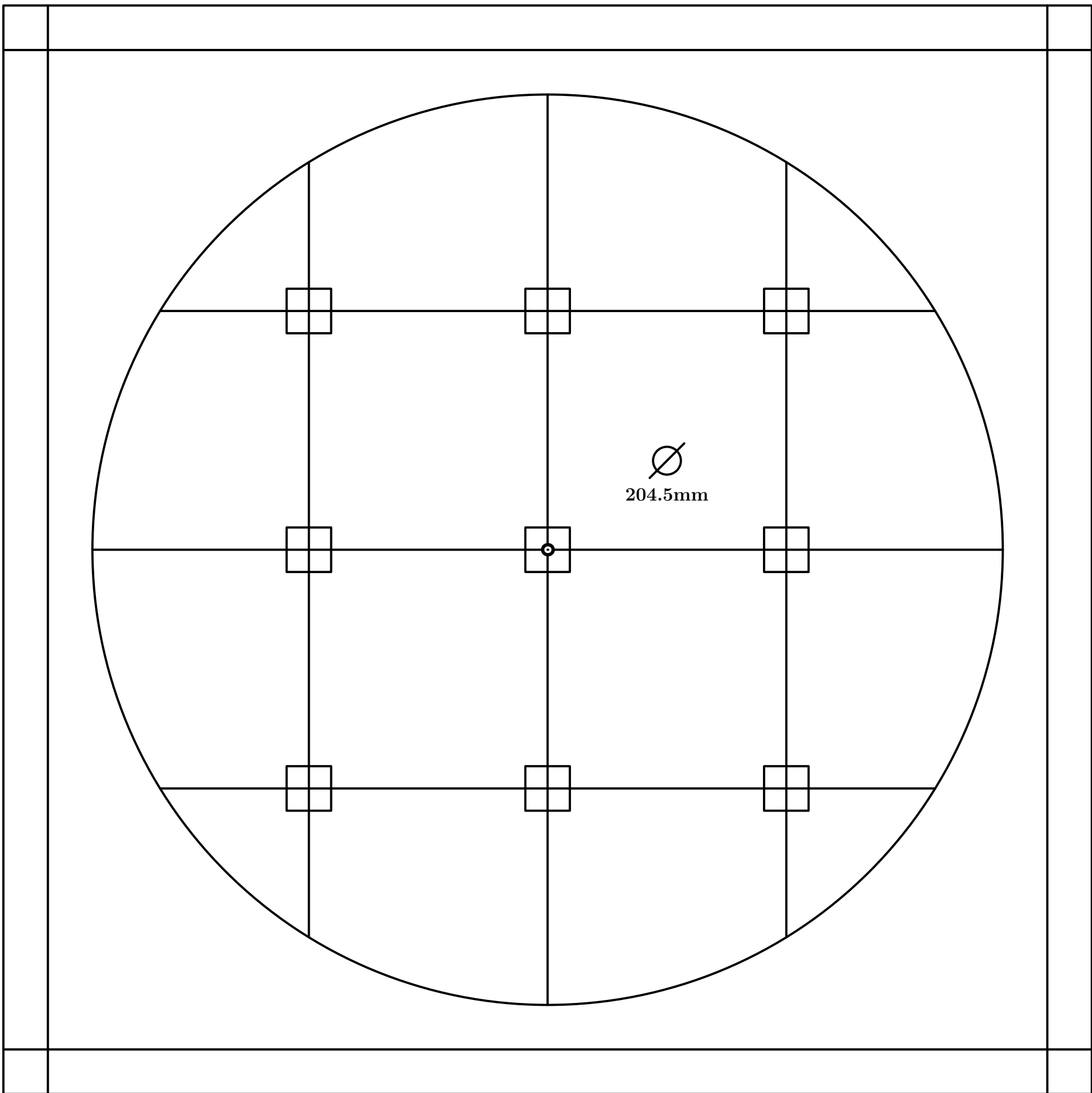

Fig. 419

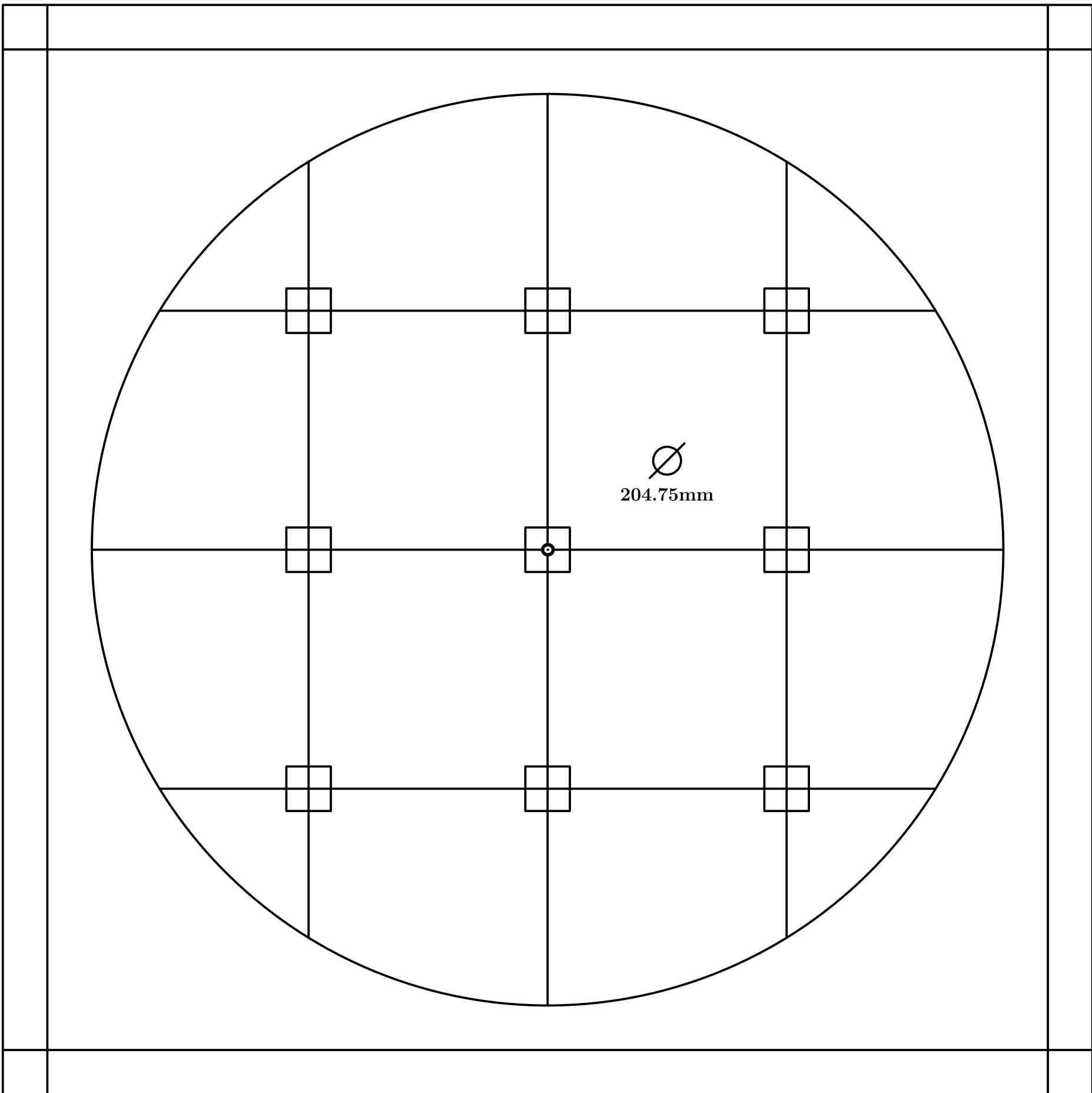

Fig. 420

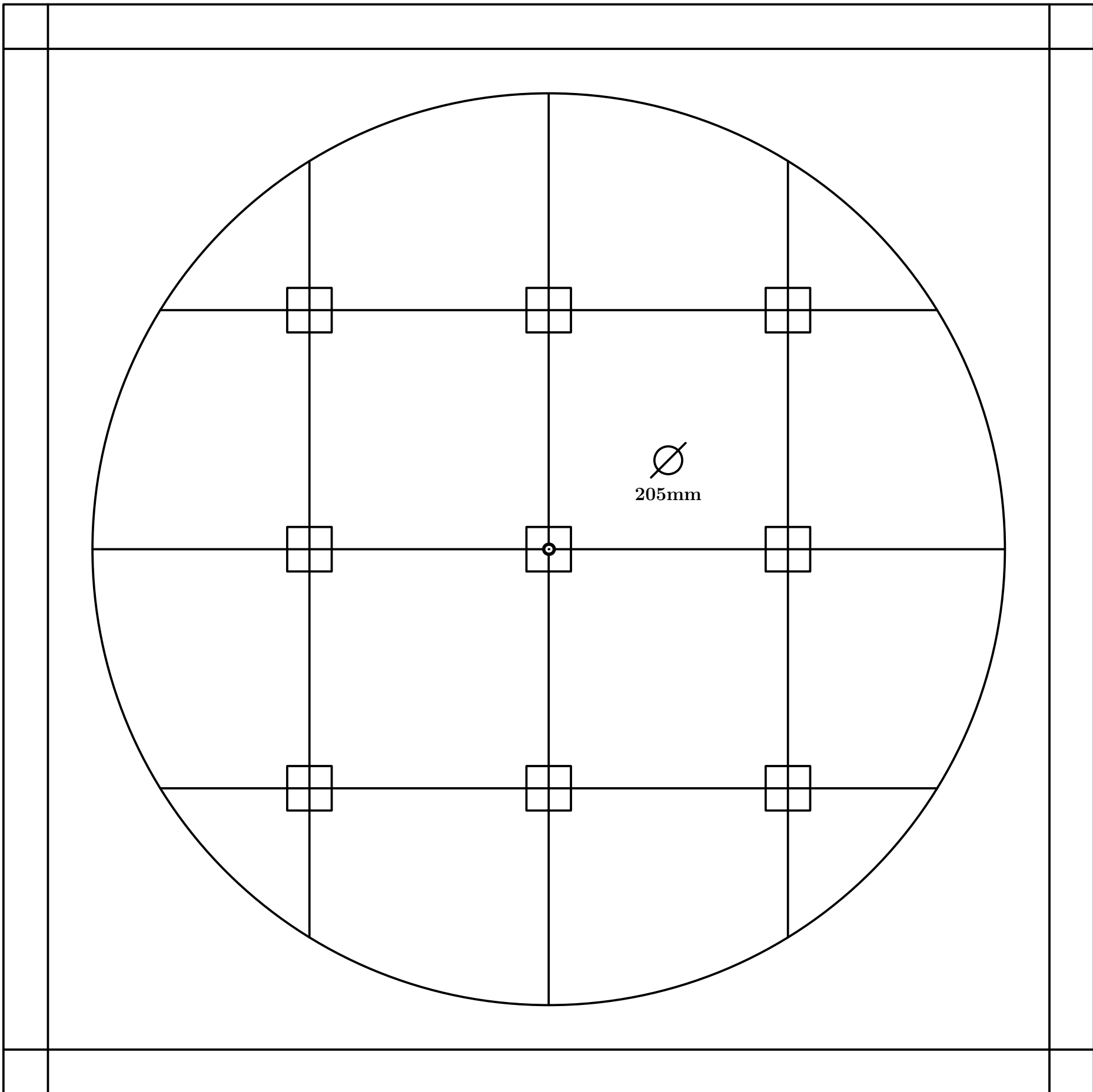

Fig. 421

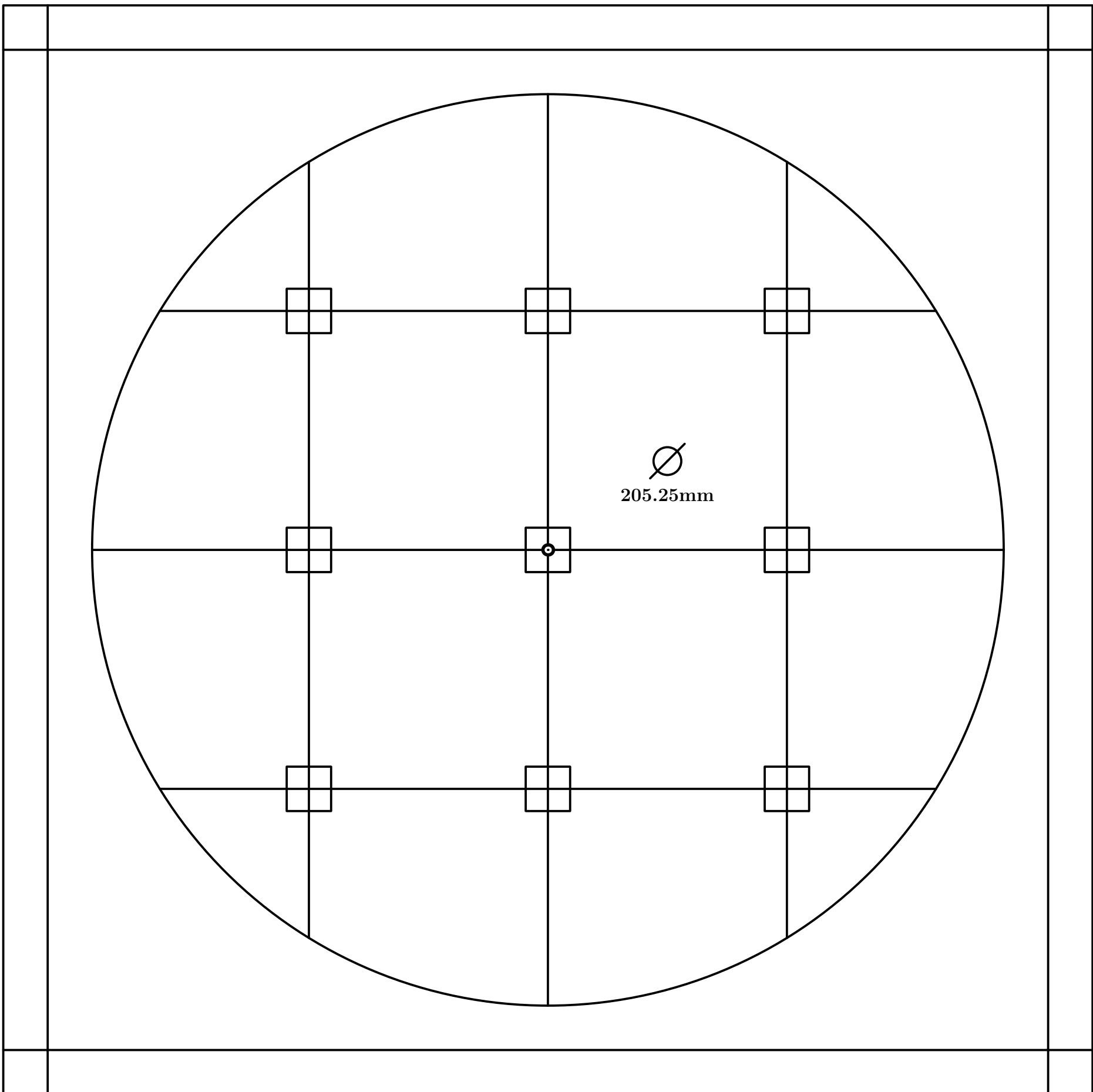

Fig. 422

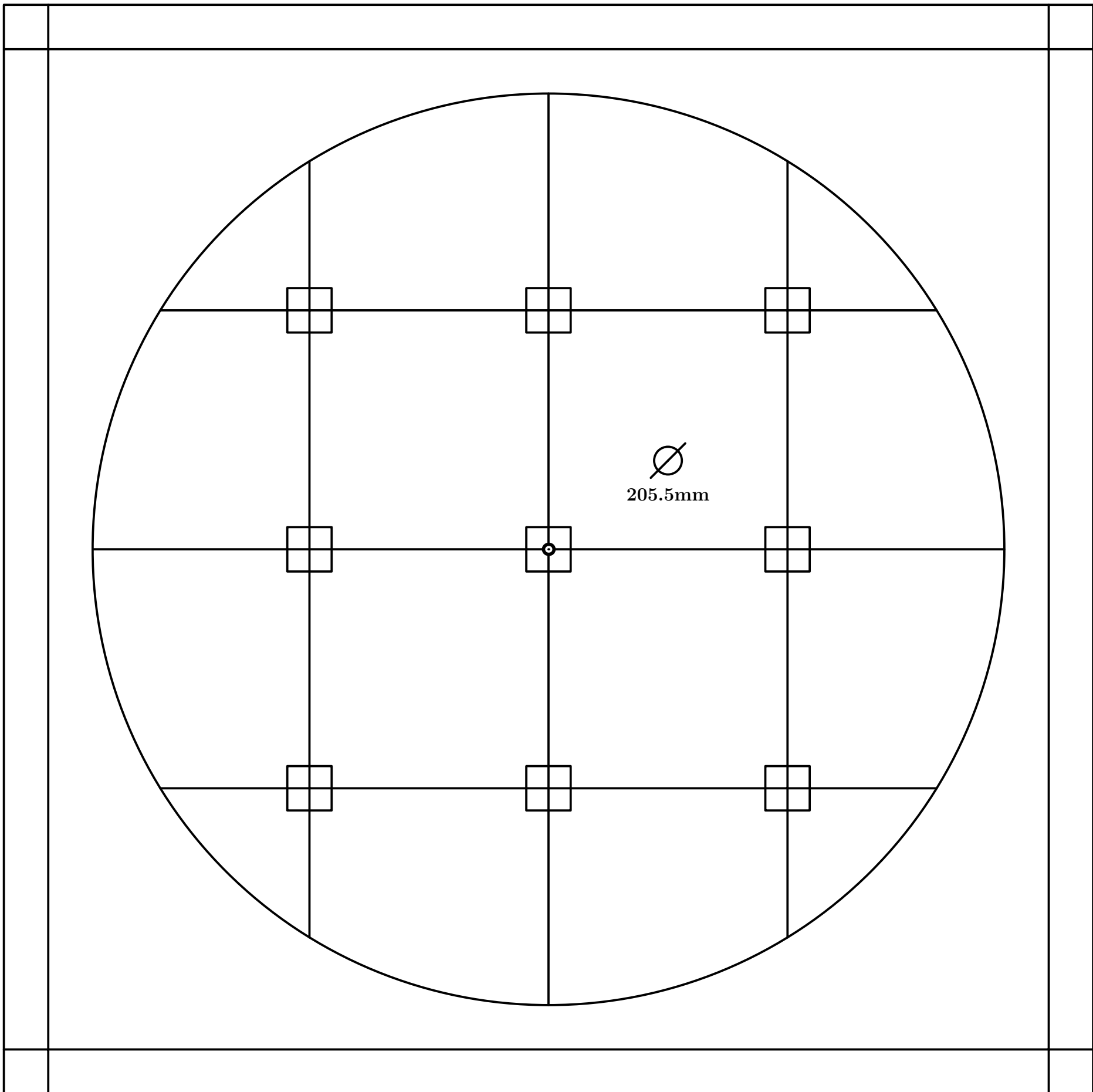

Fig. 423

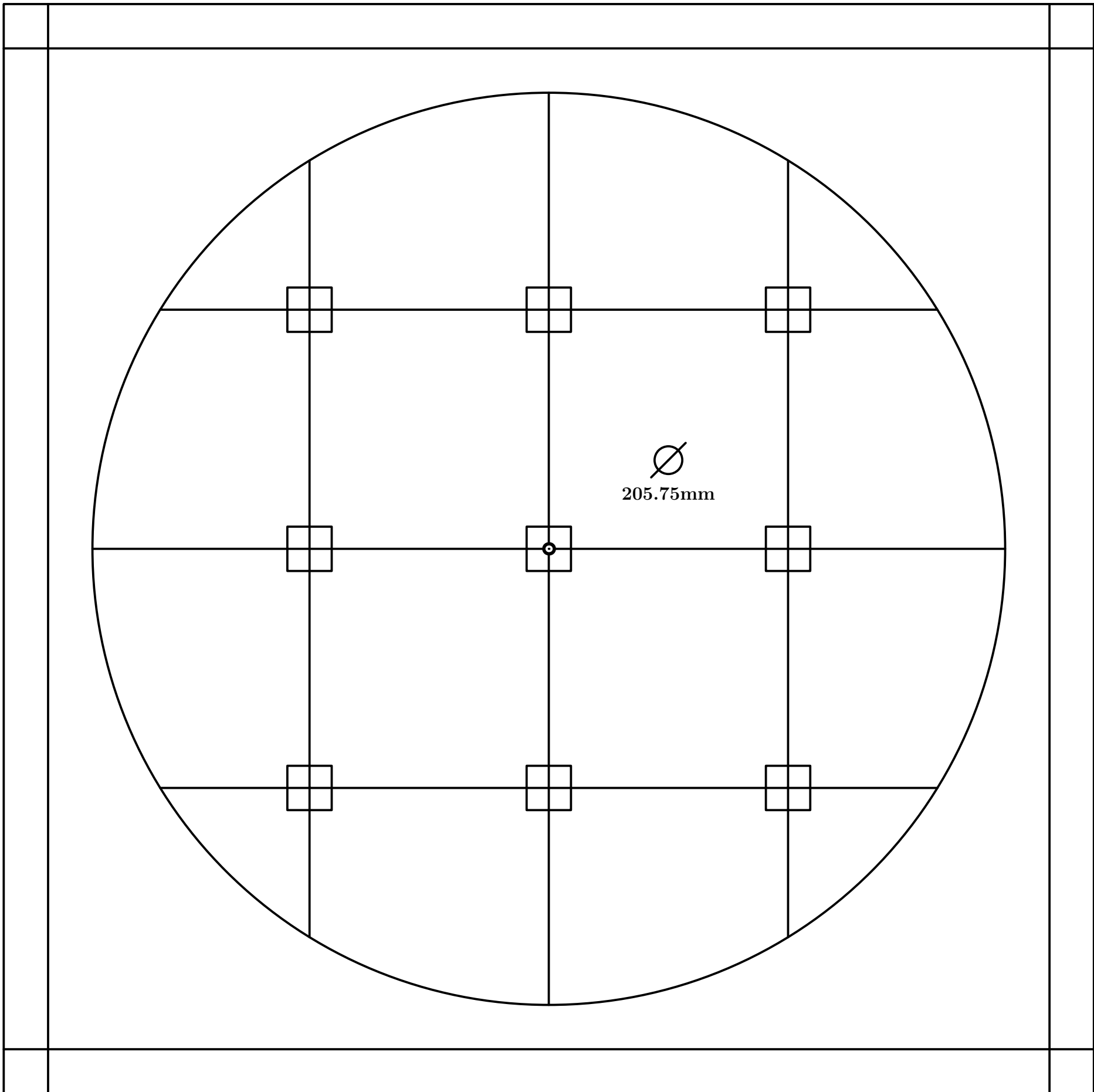

Fig. 424

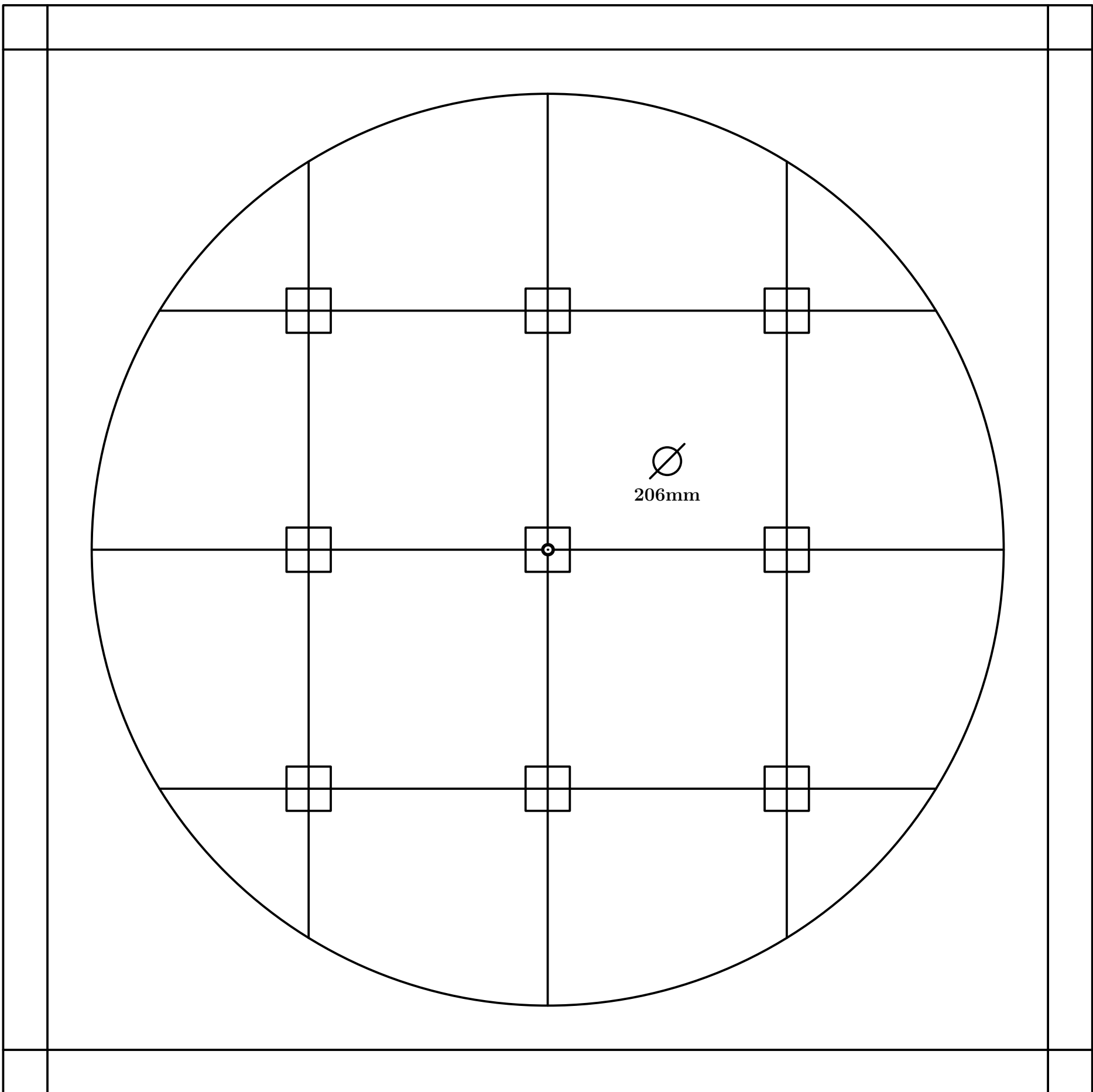

Fig. 425

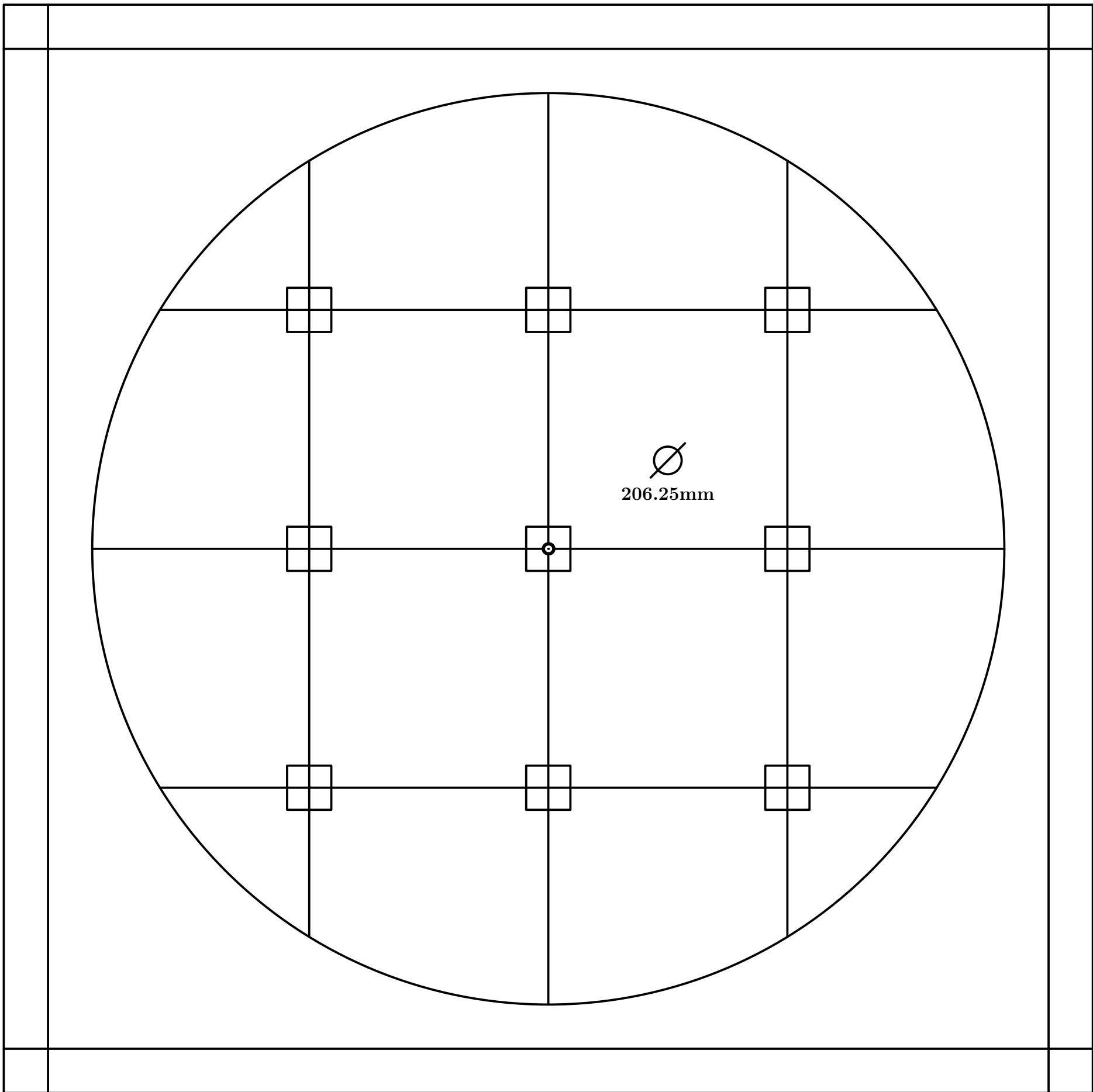

Fig. 426

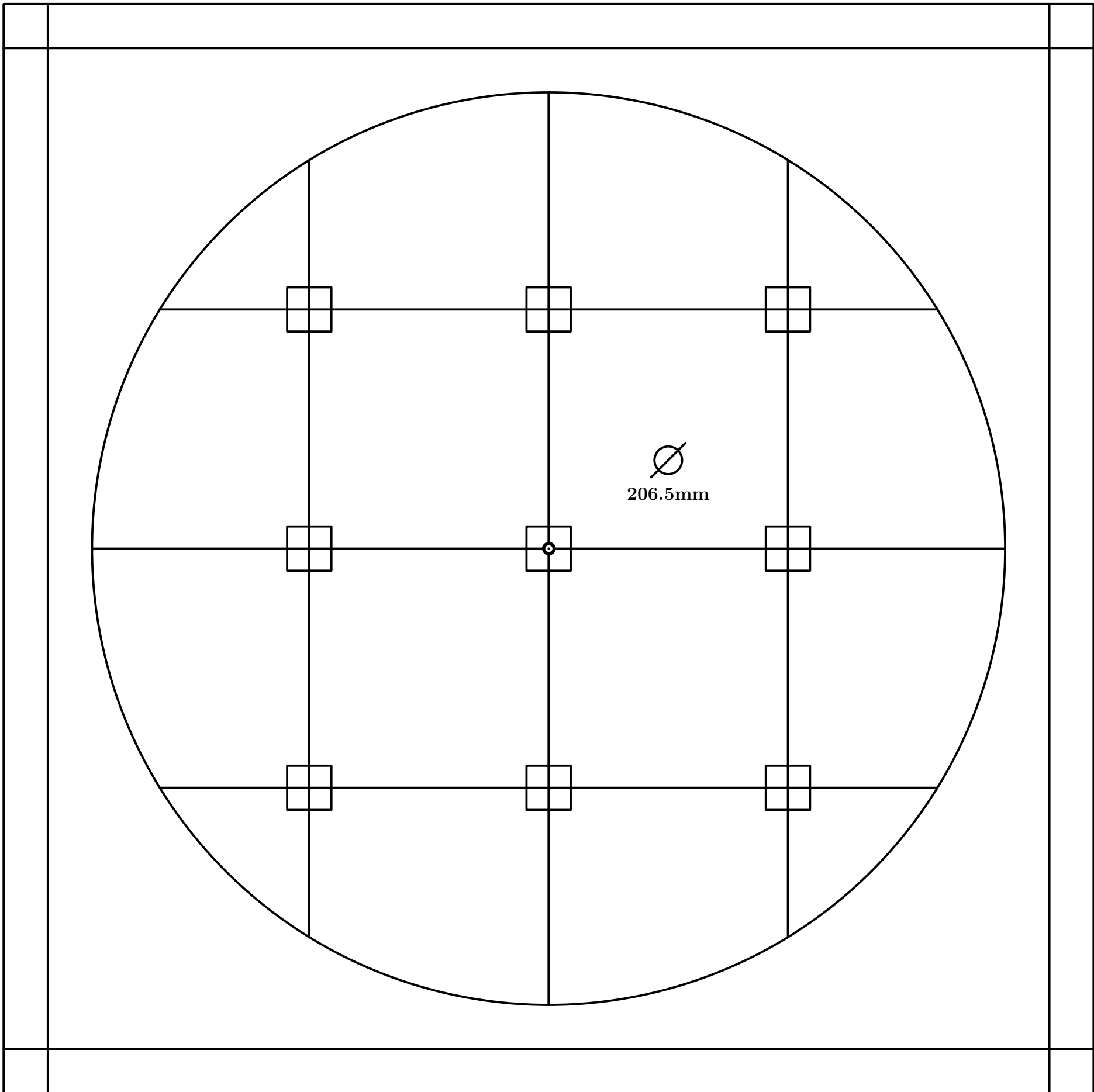

Fig. 427

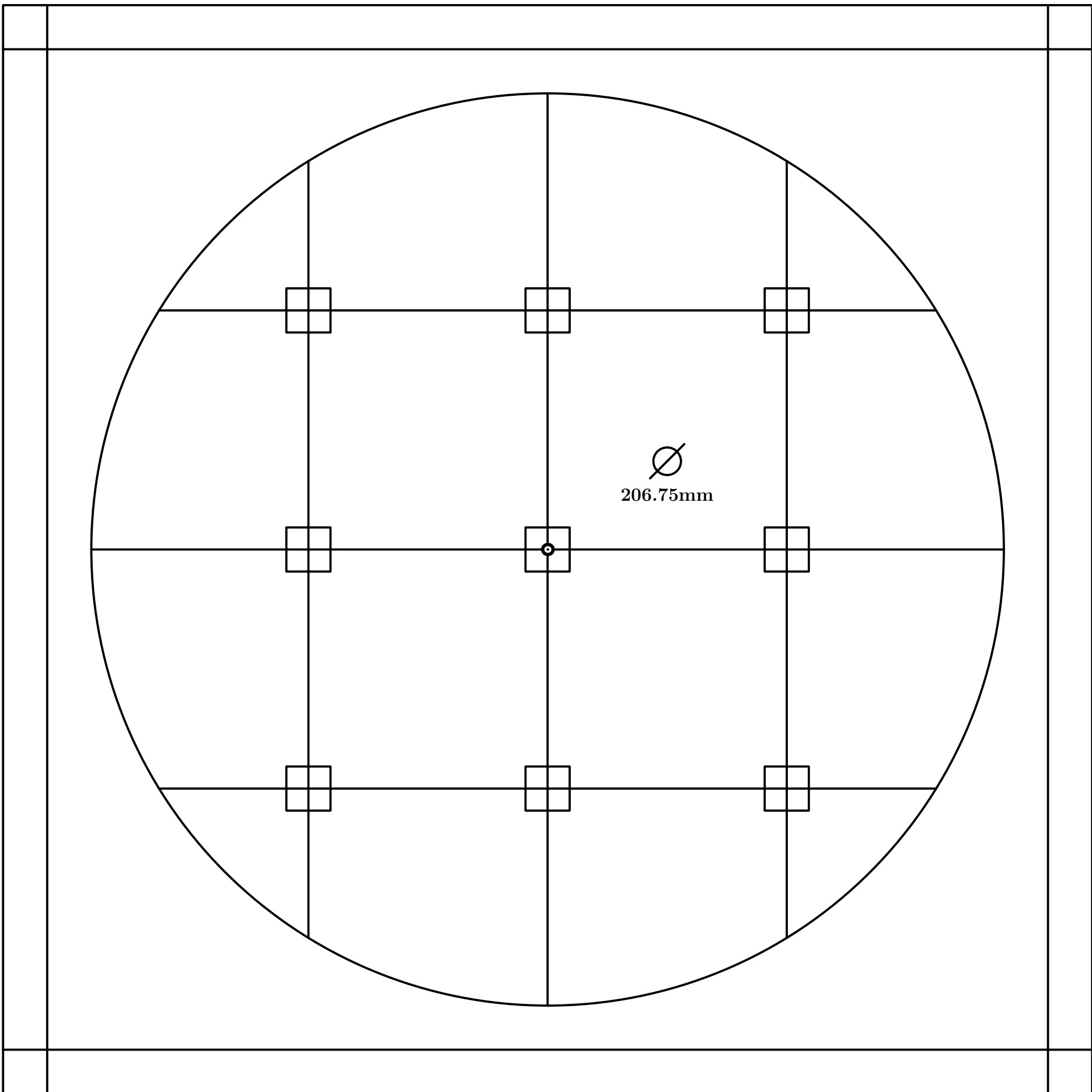

Fig. 428

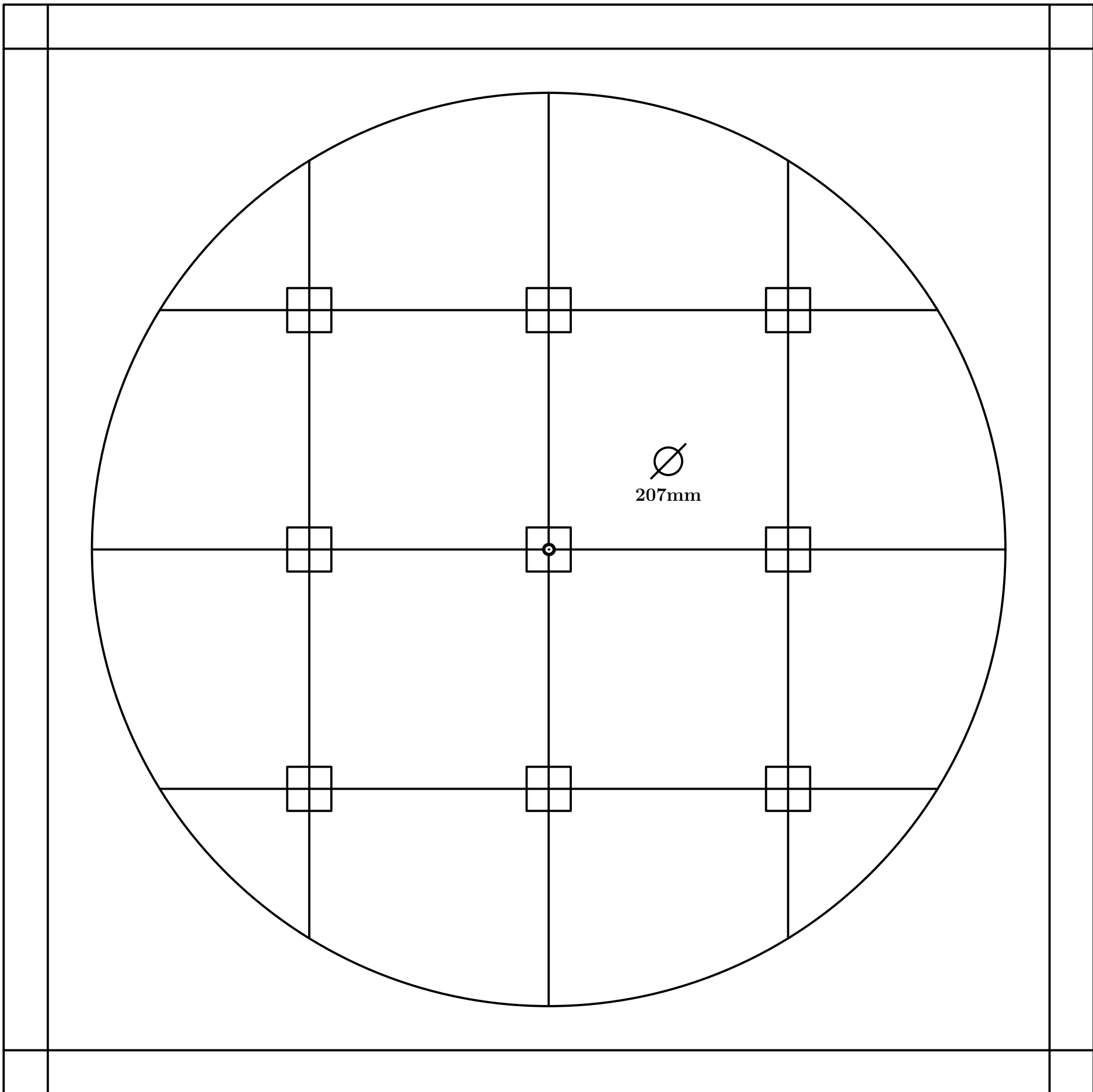

Fig. 429

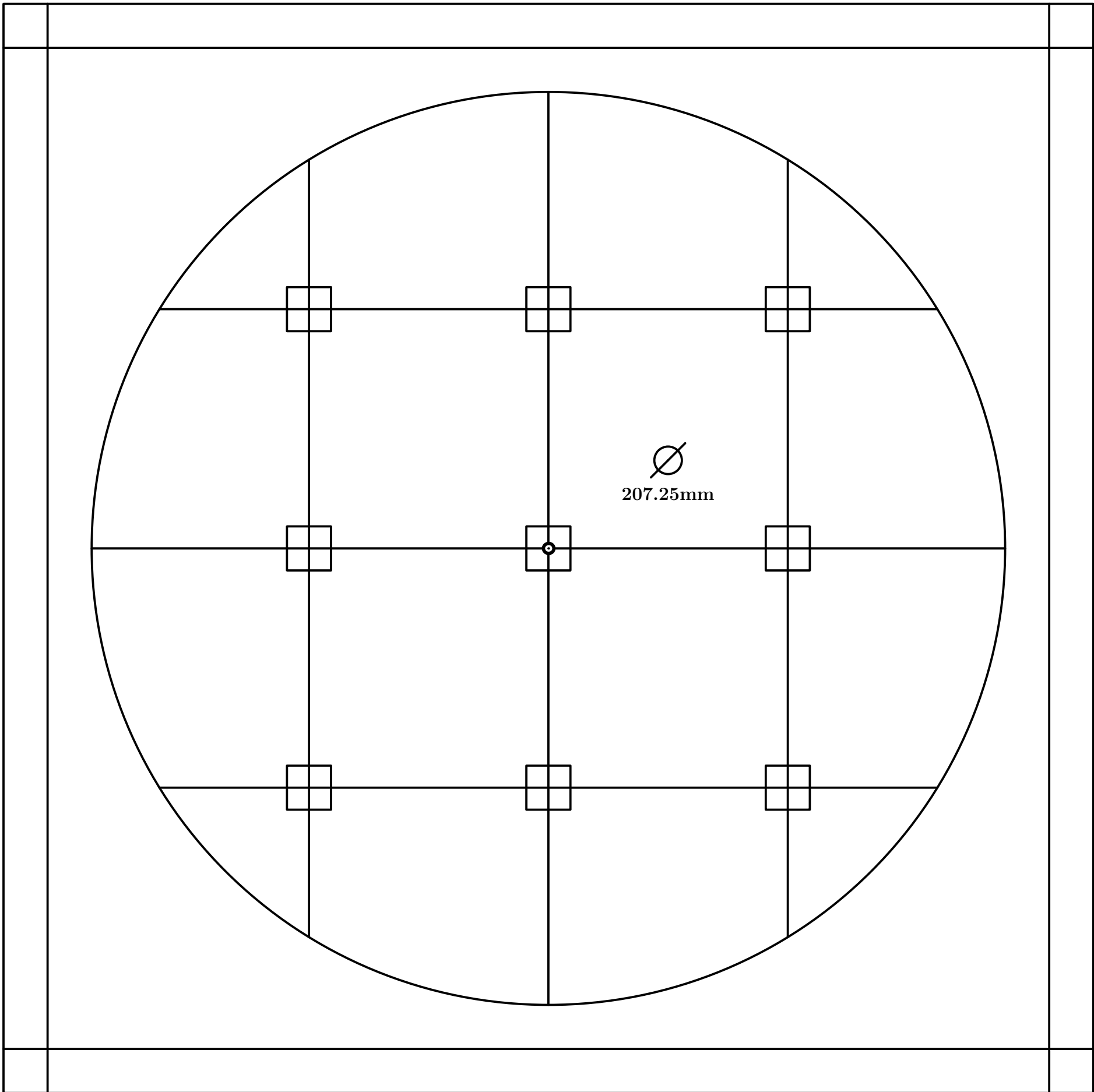

Fig. 430

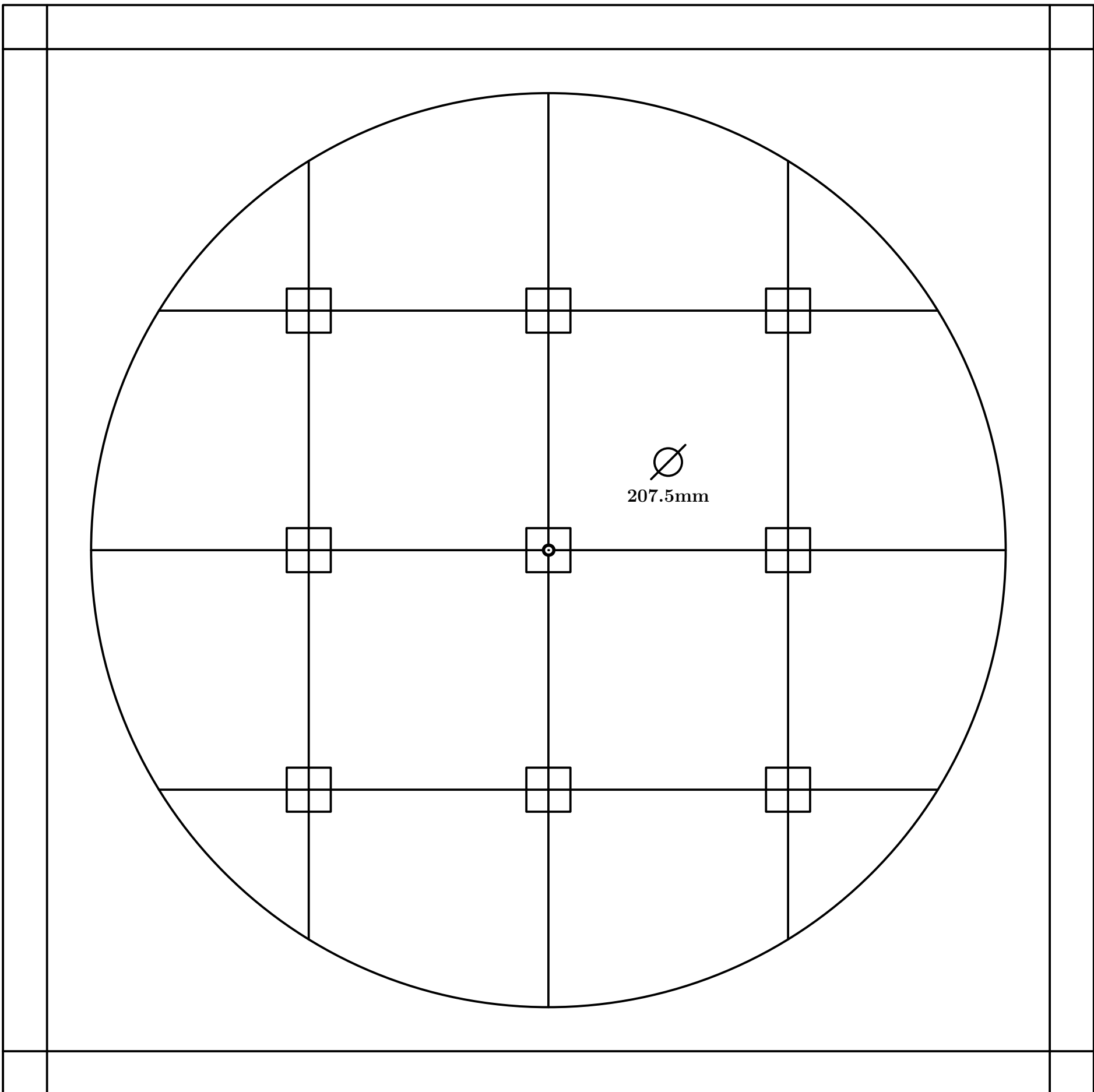

Fig. 431

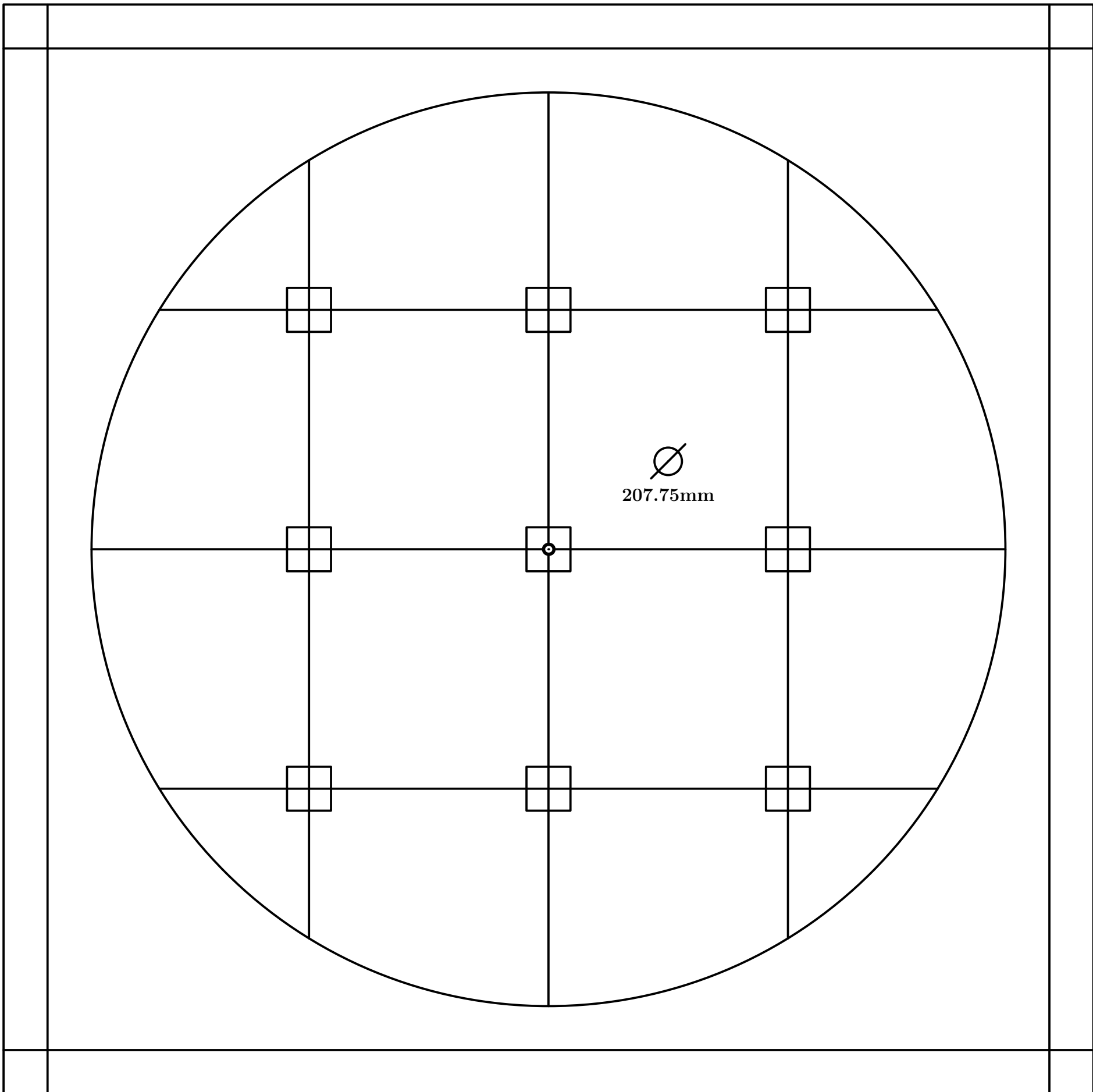

Fig. 432

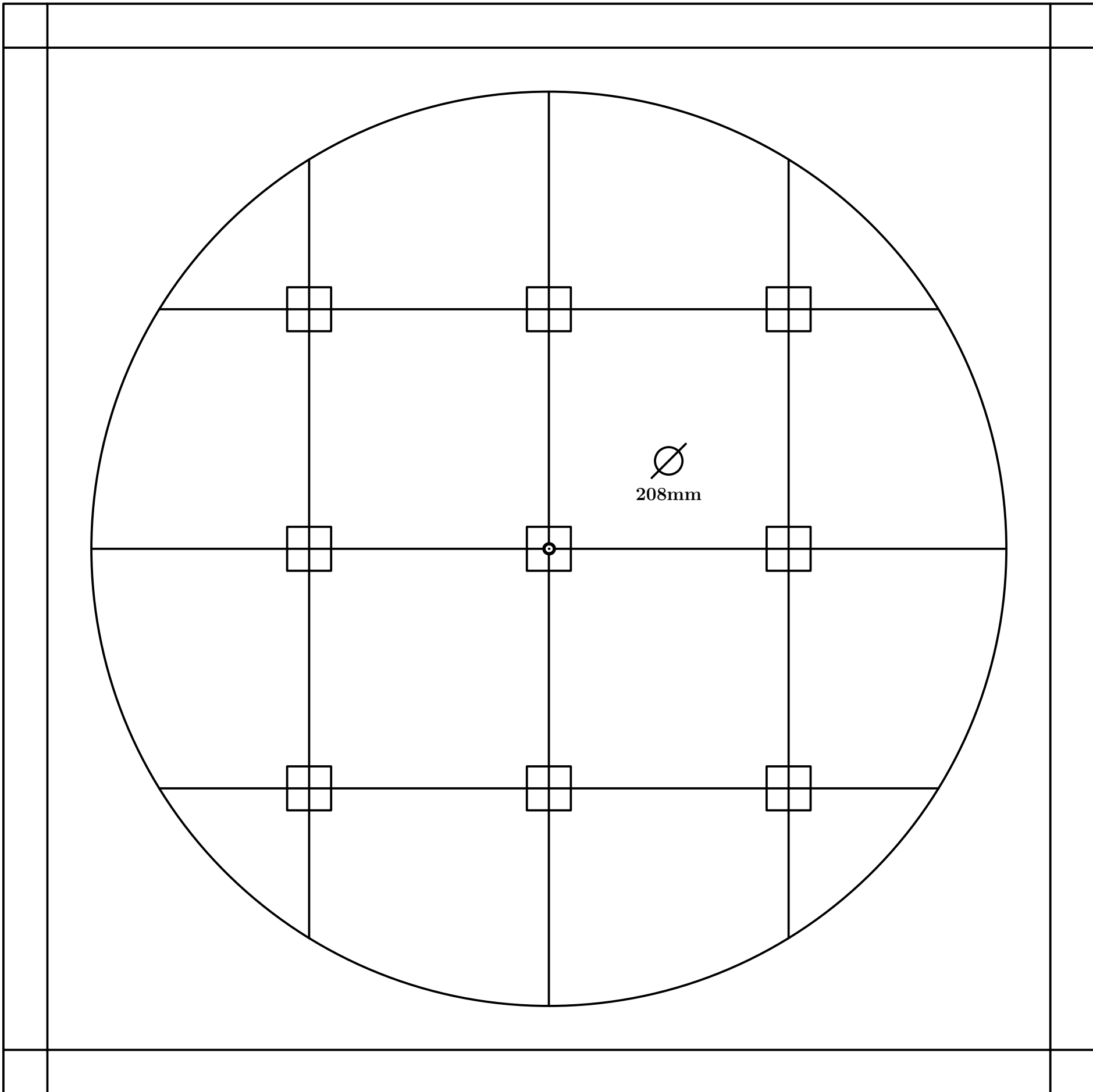

Fig. 433

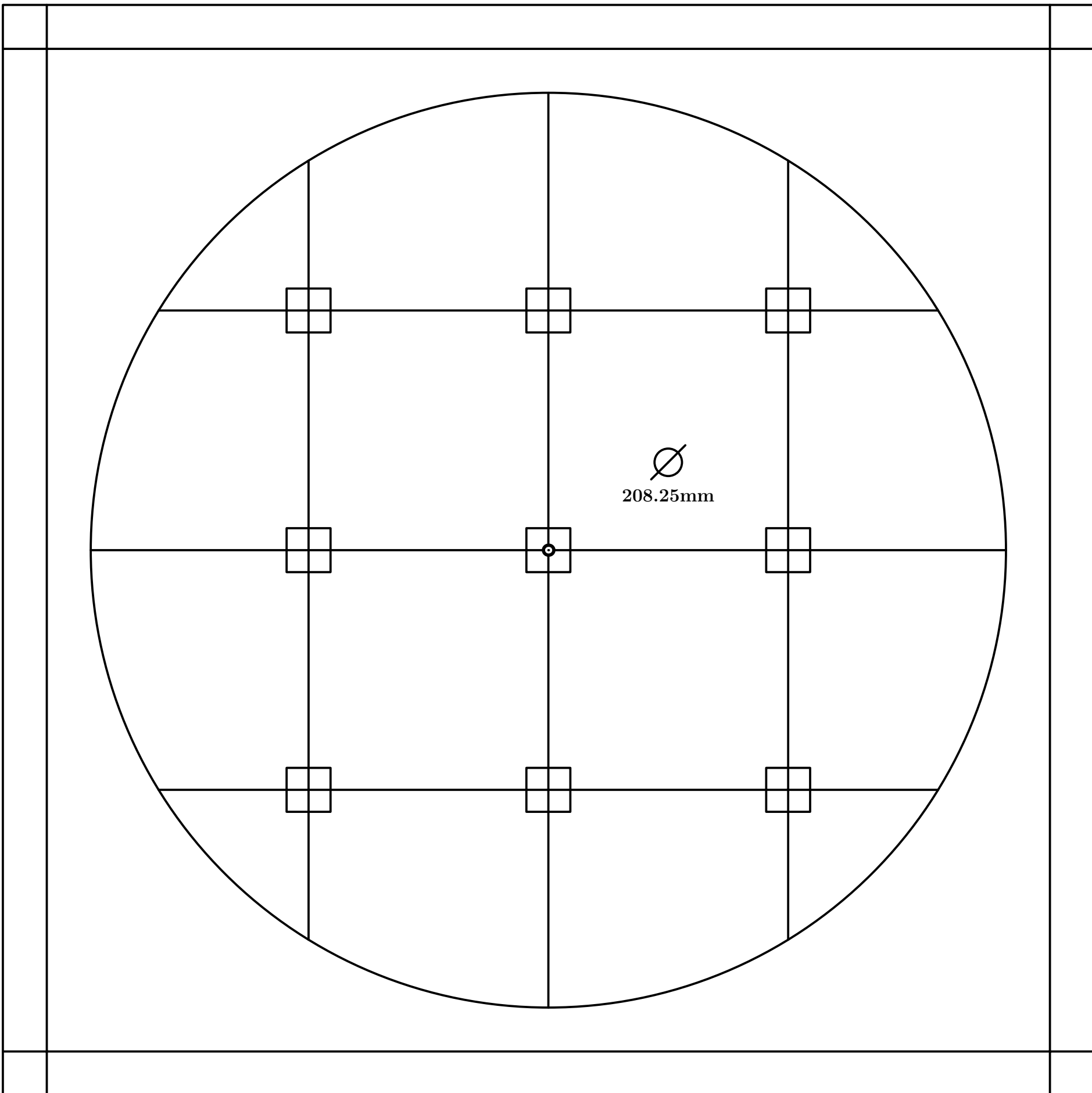

Fig. 434

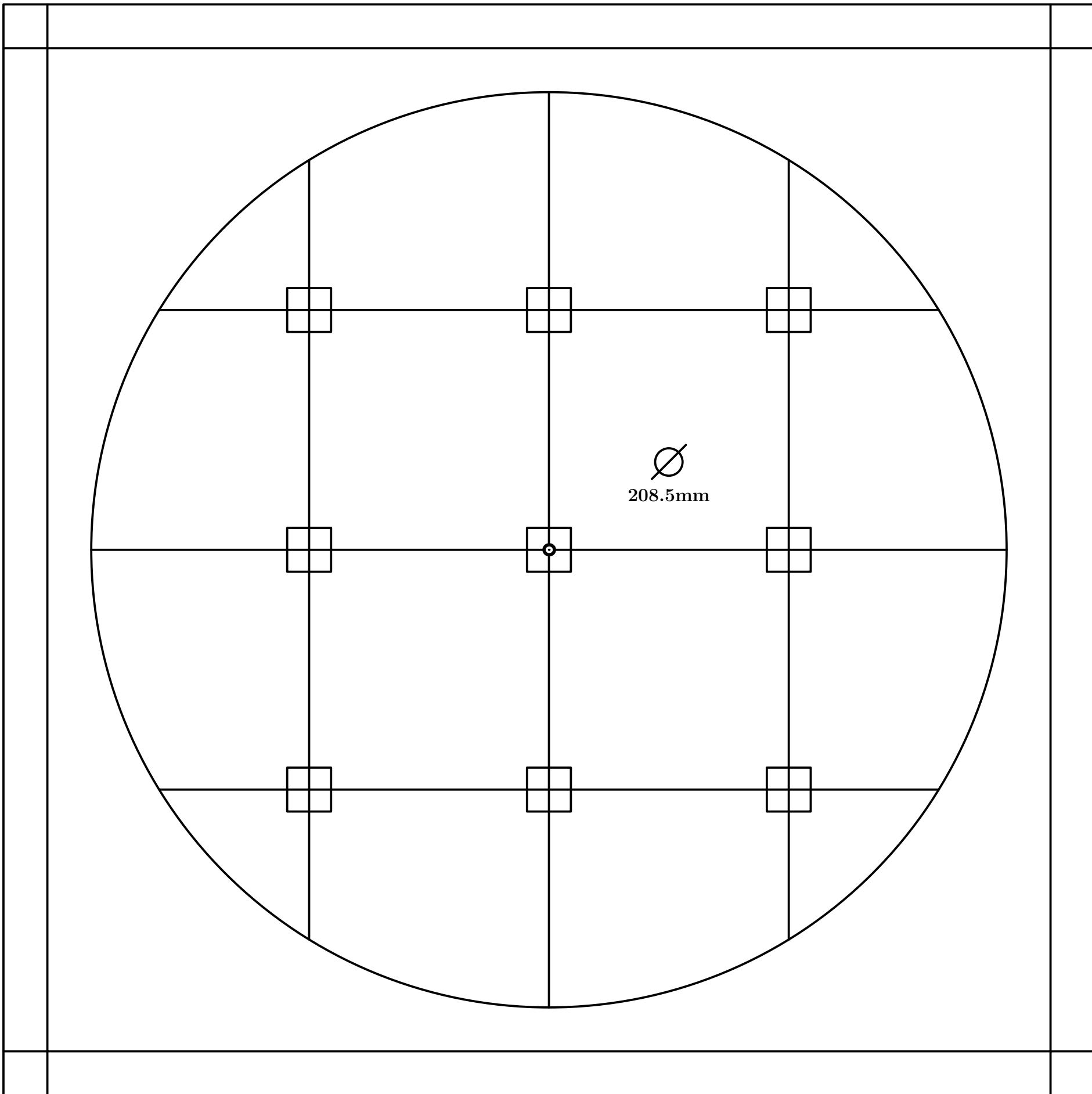

Fig. 435

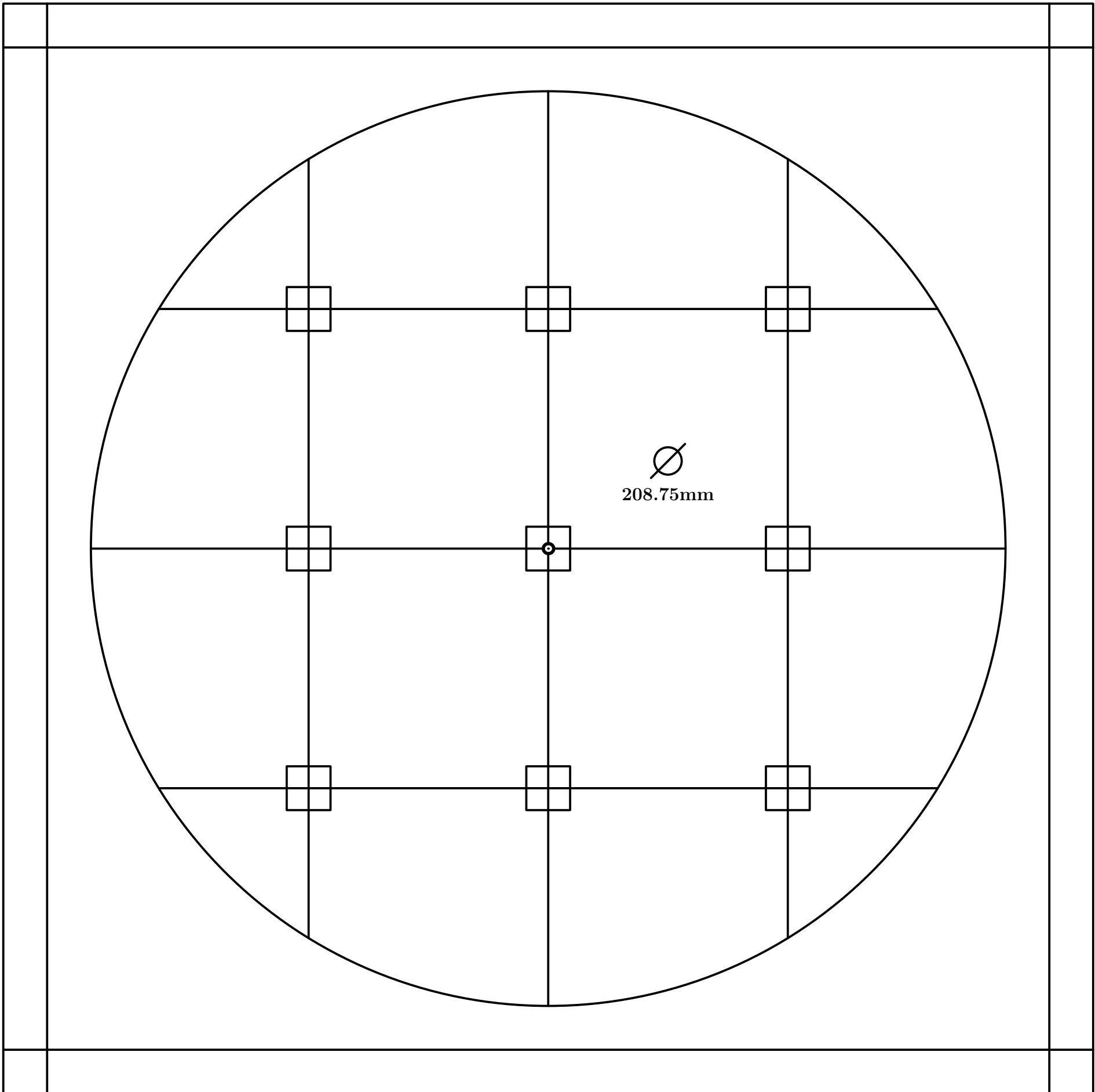

Fig. 436

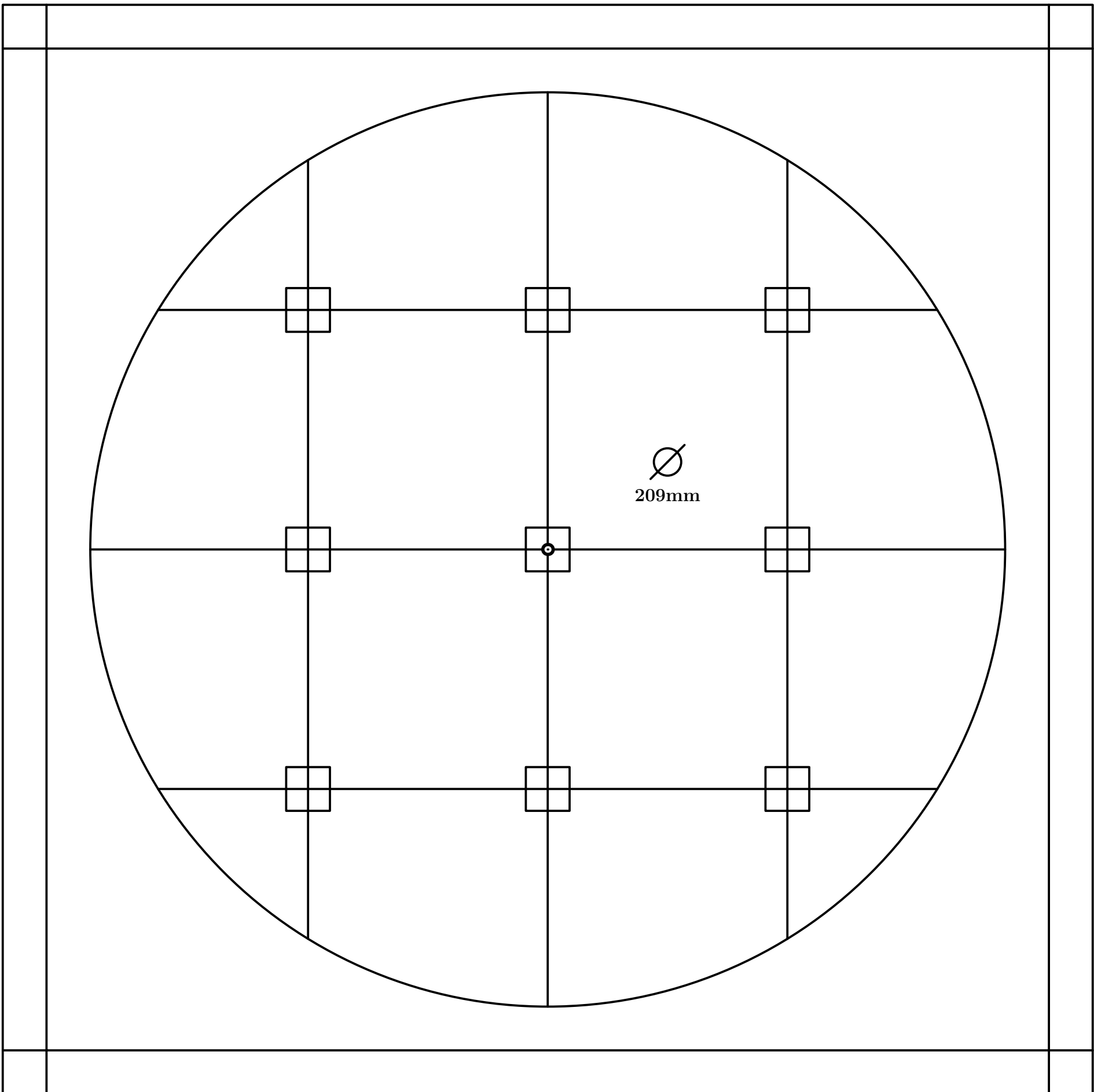

Fig. 437

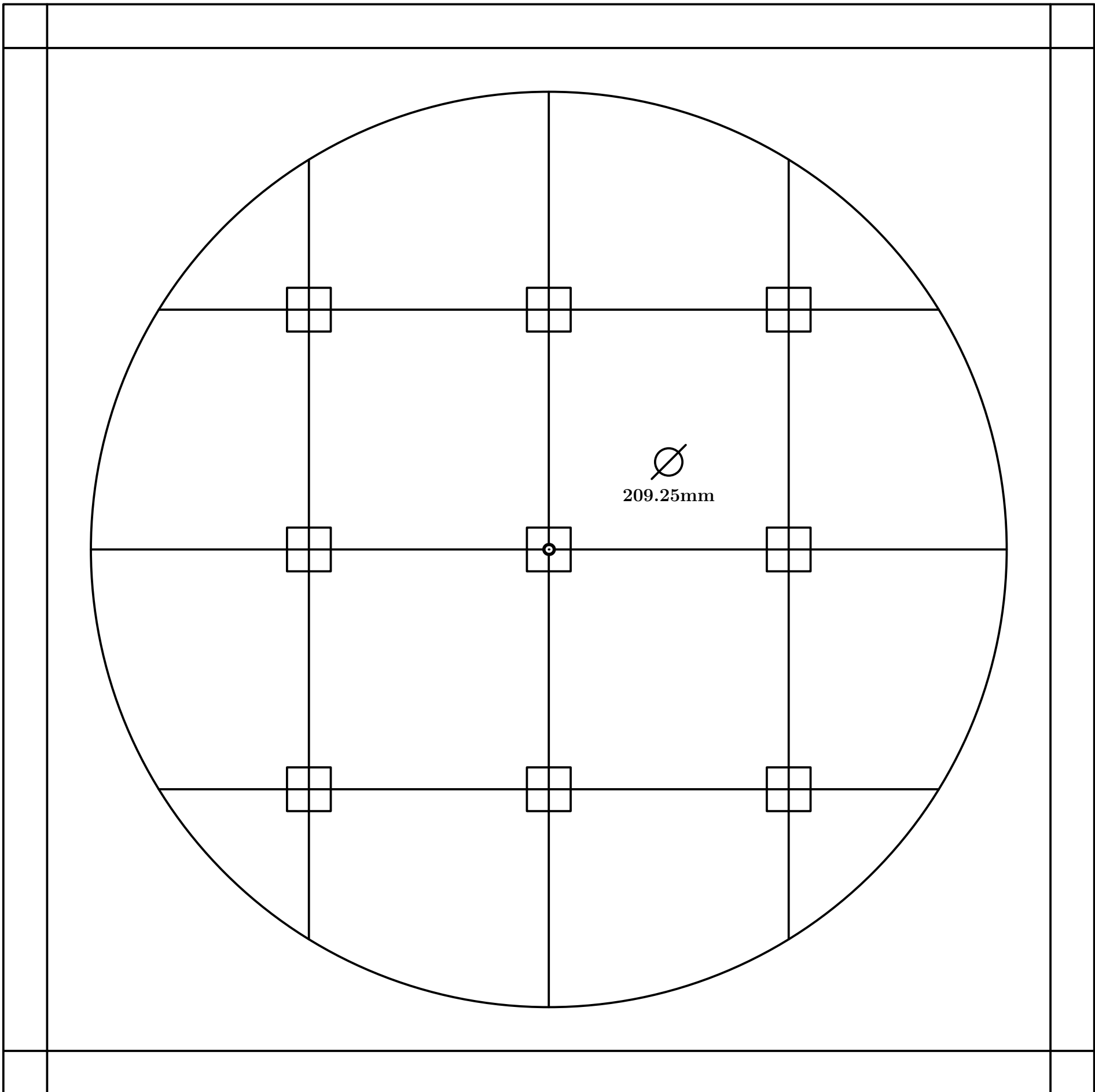

Fig. 438

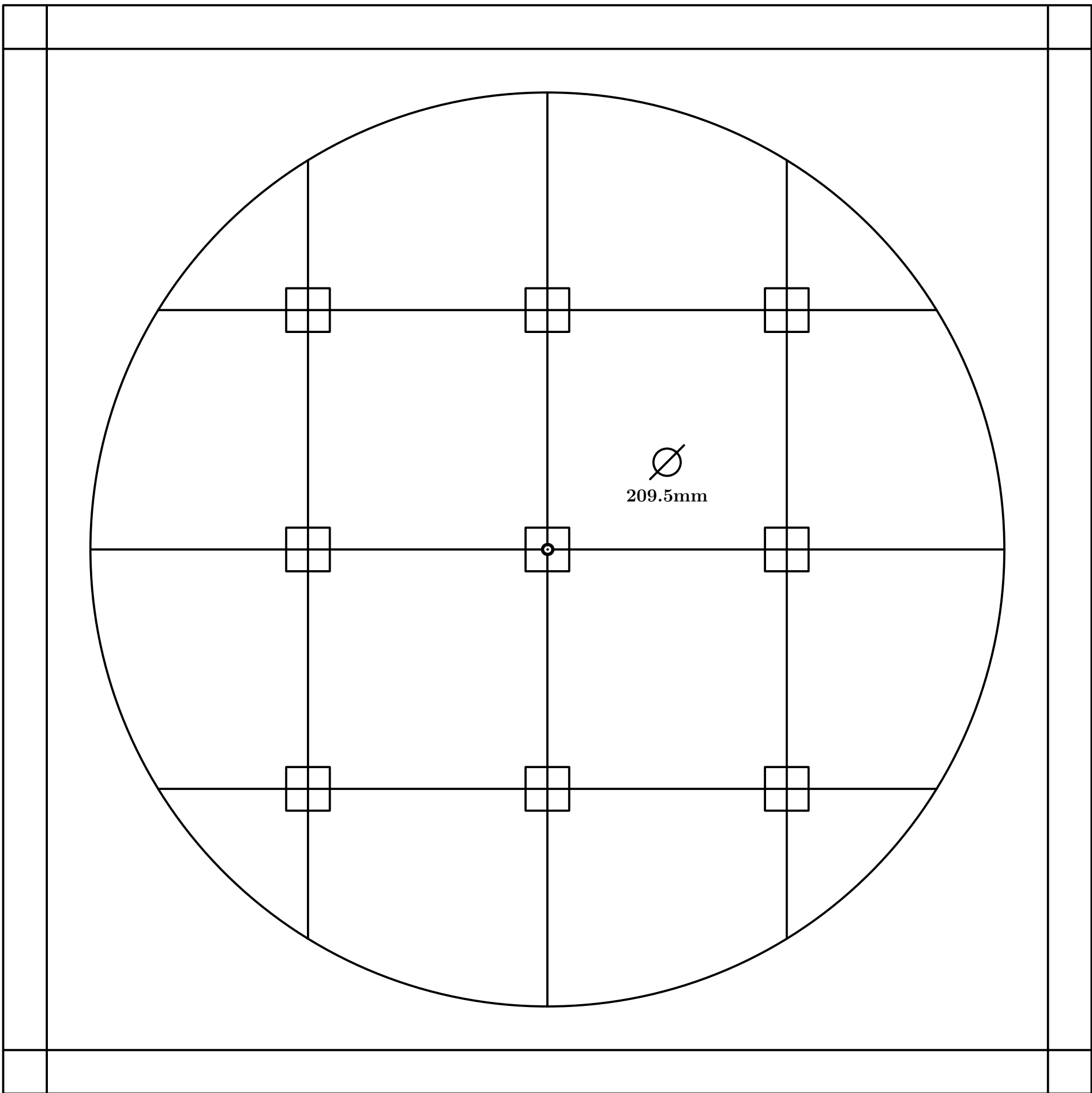

Fig. 439

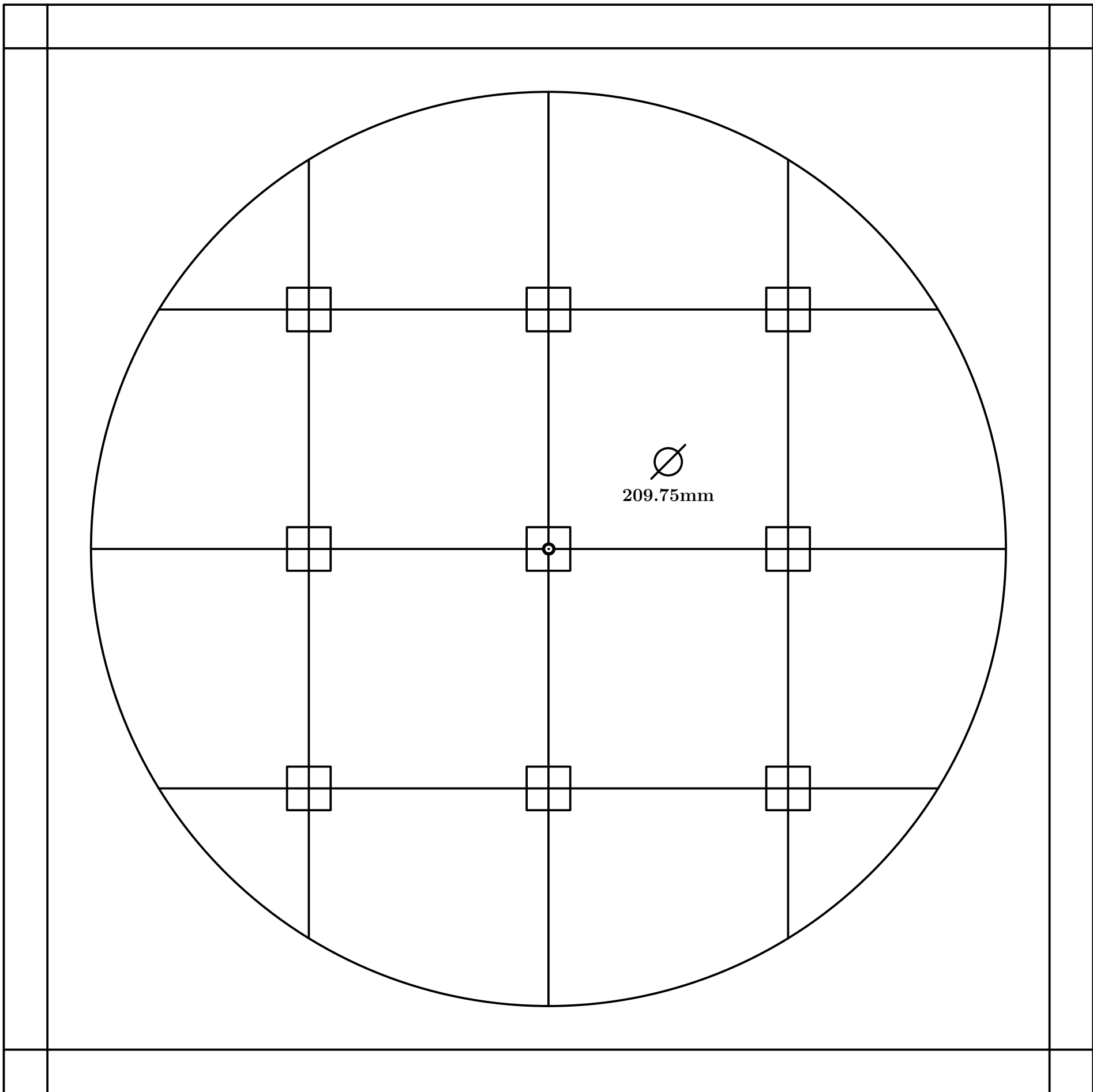

Fig. 440

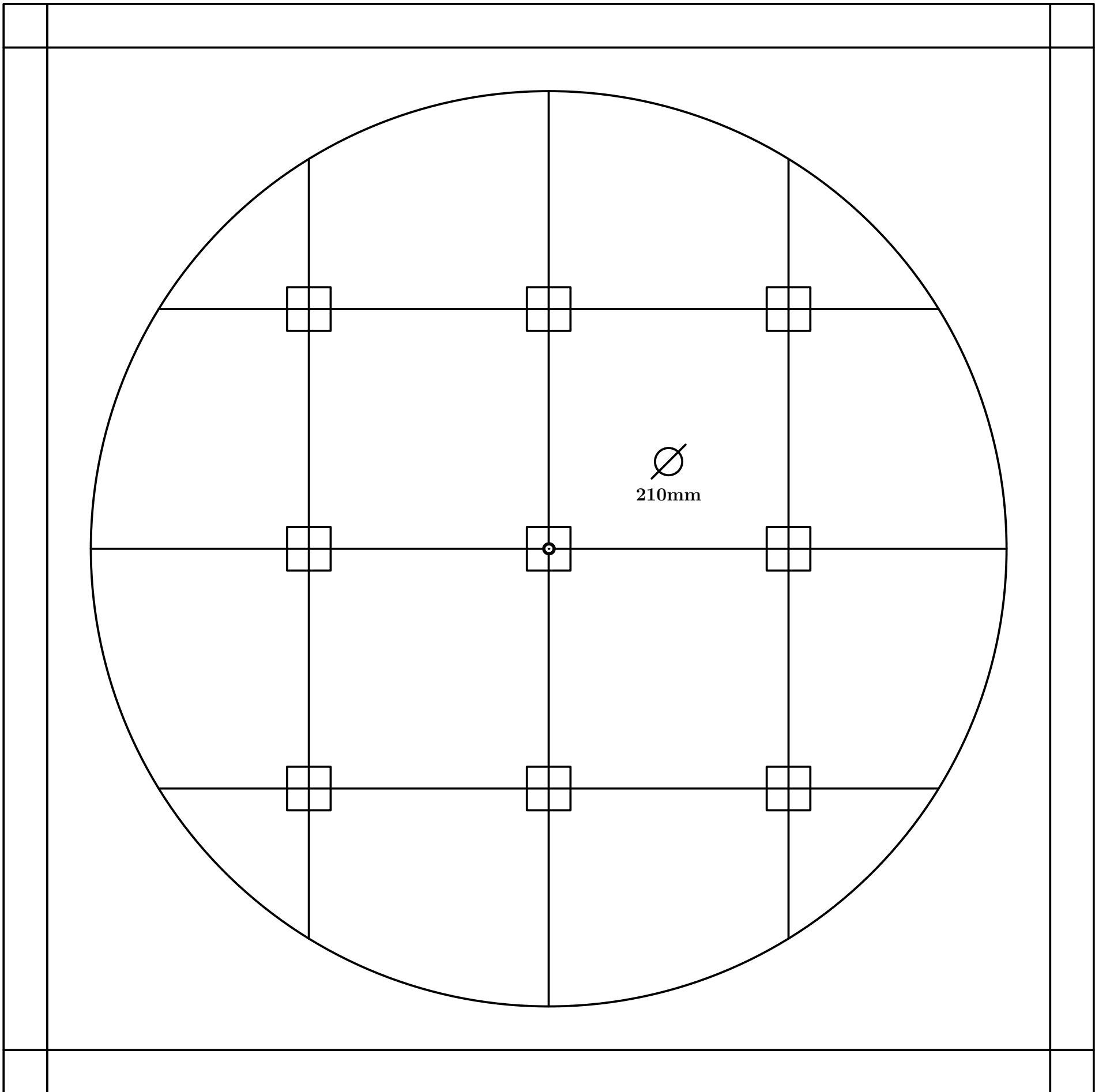

Fig. 441

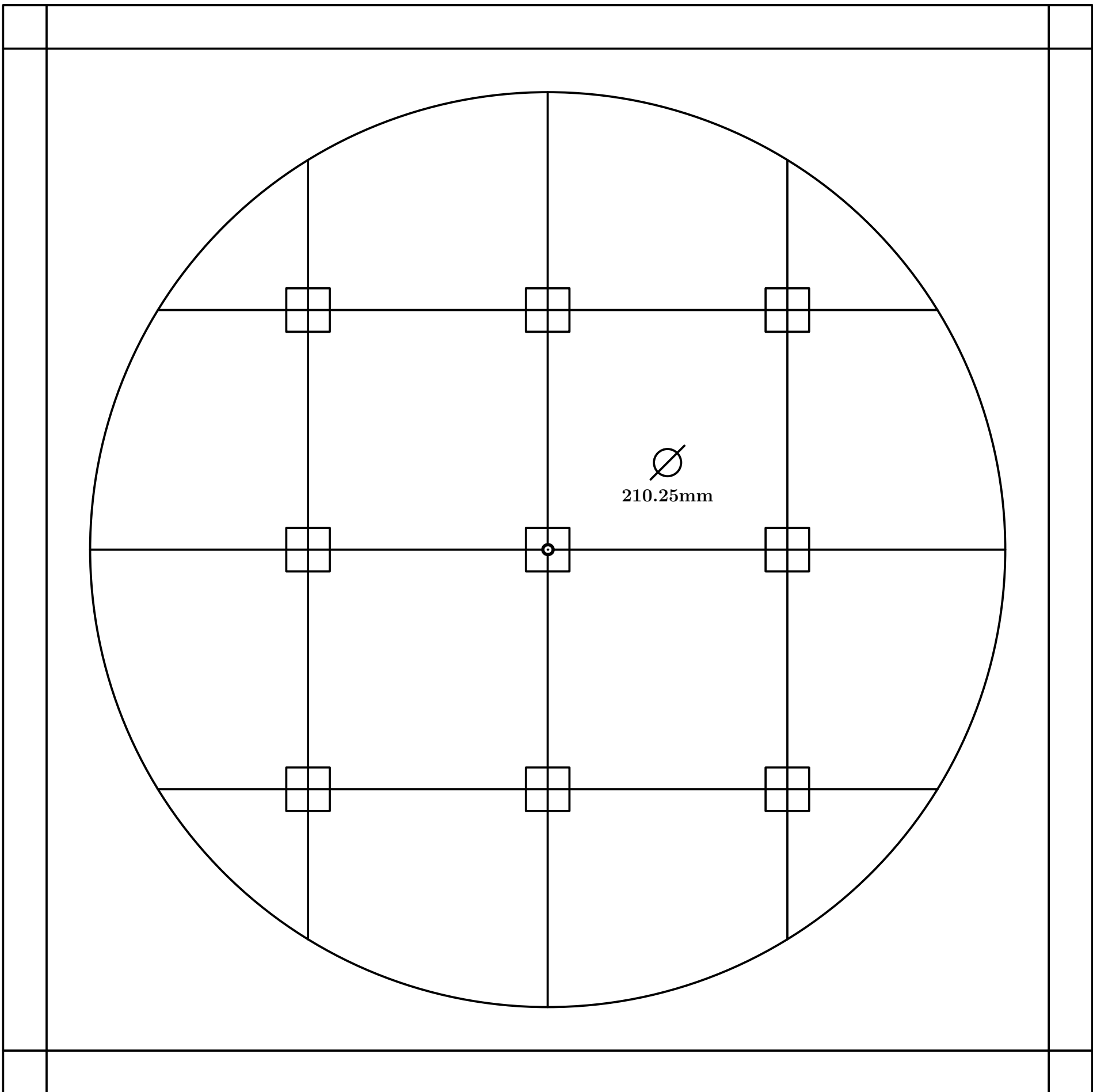

Fig. 442

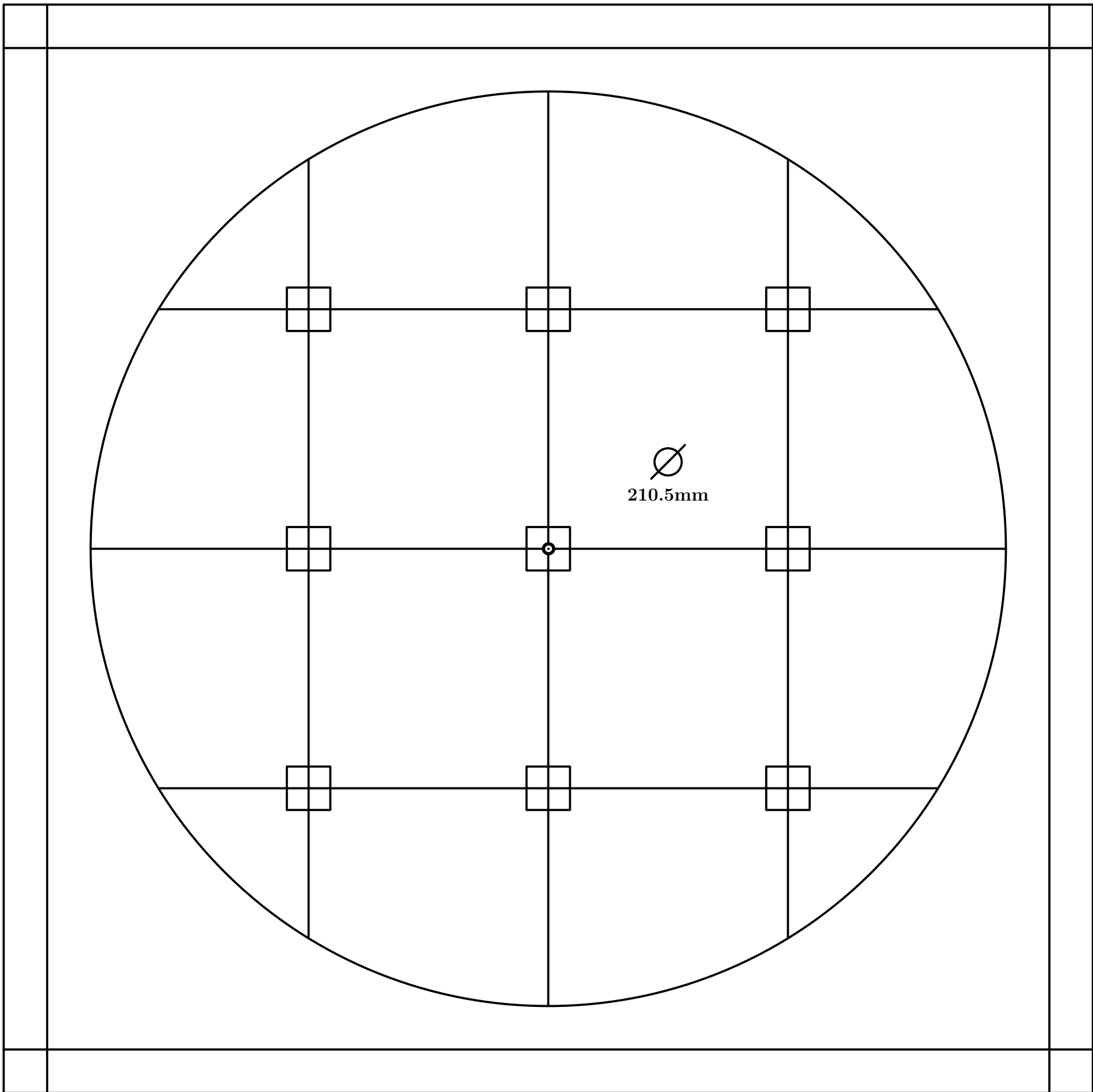

Fig. 443

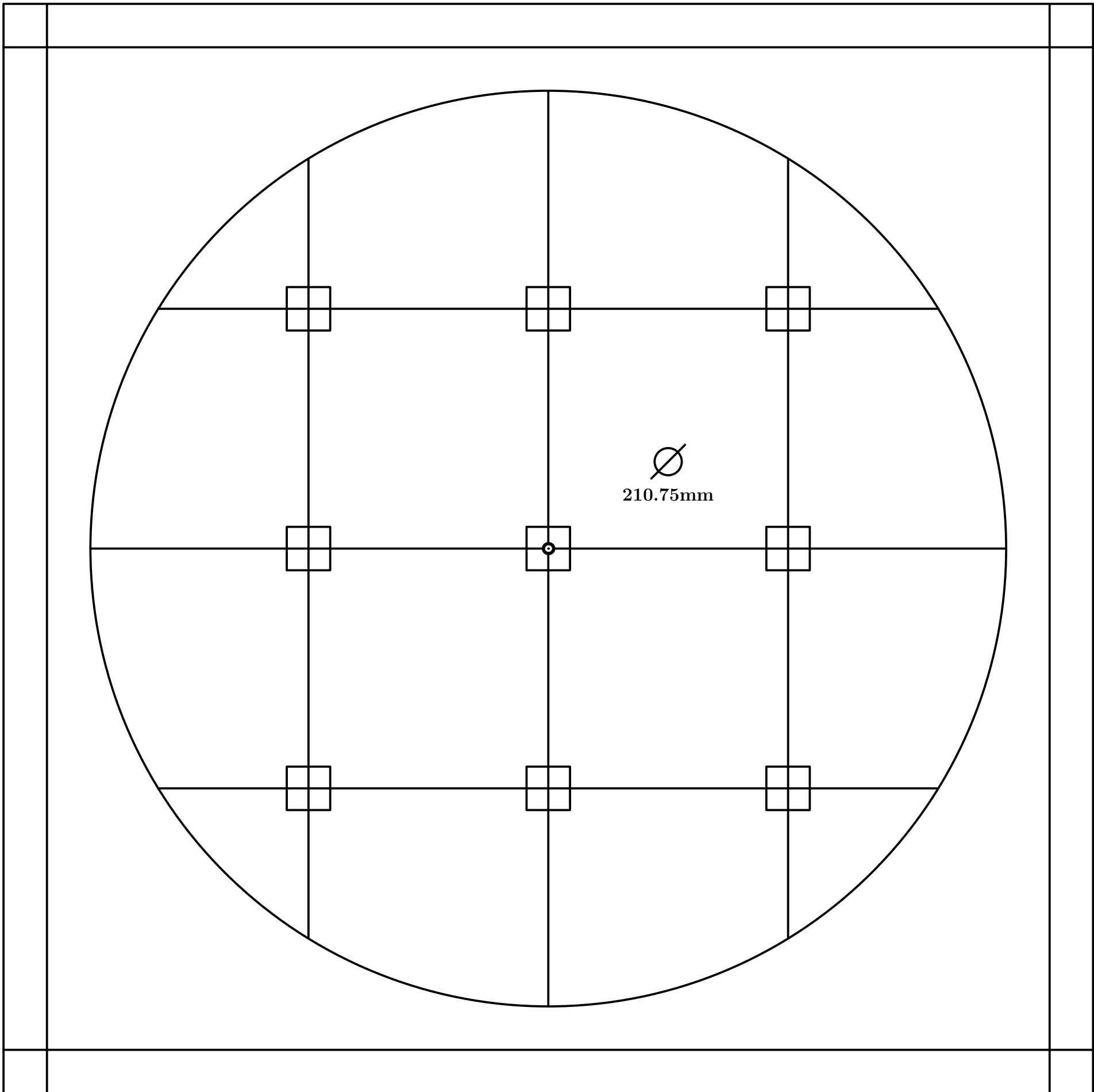

Fig. 444

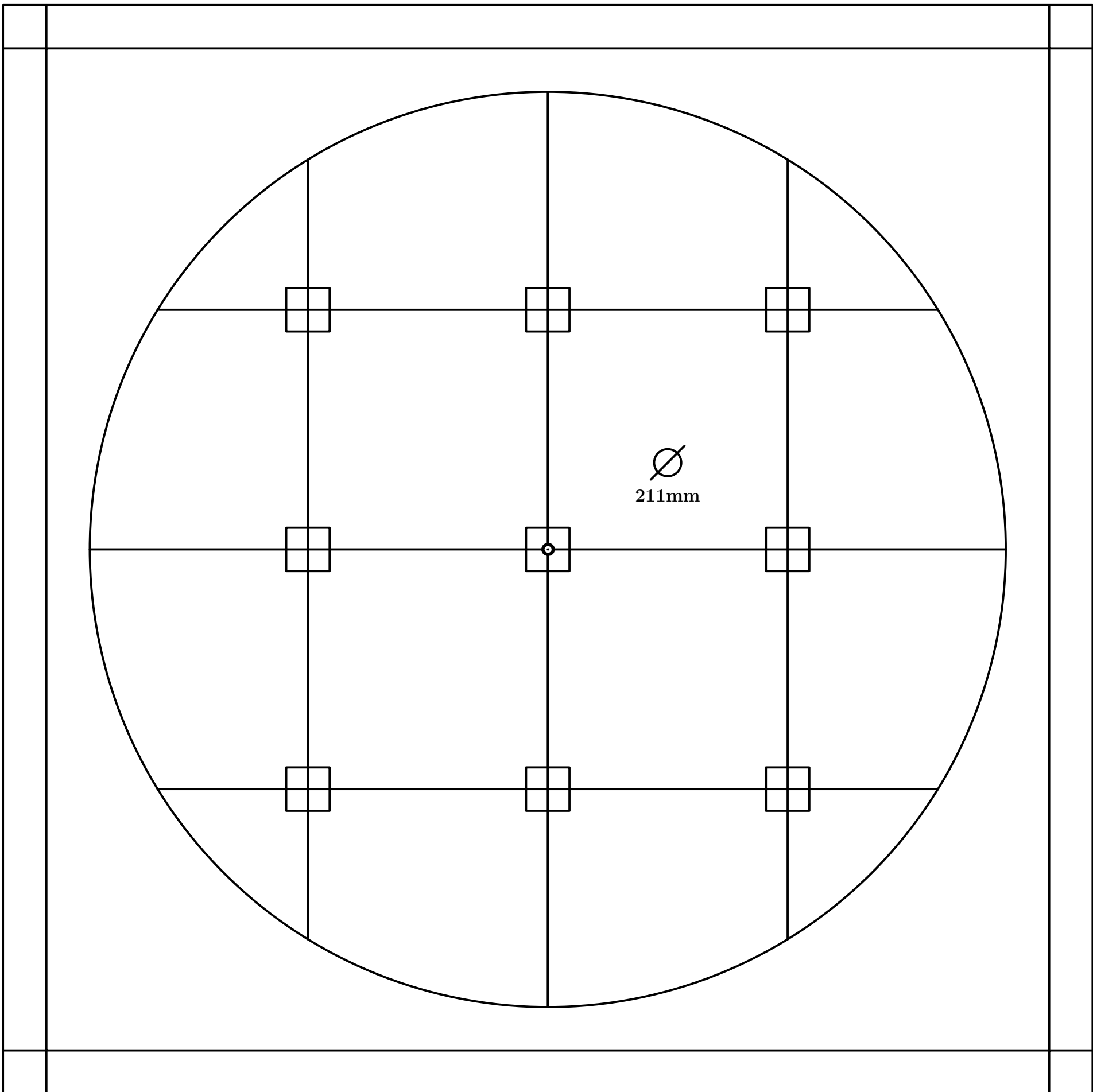

Fig. 445

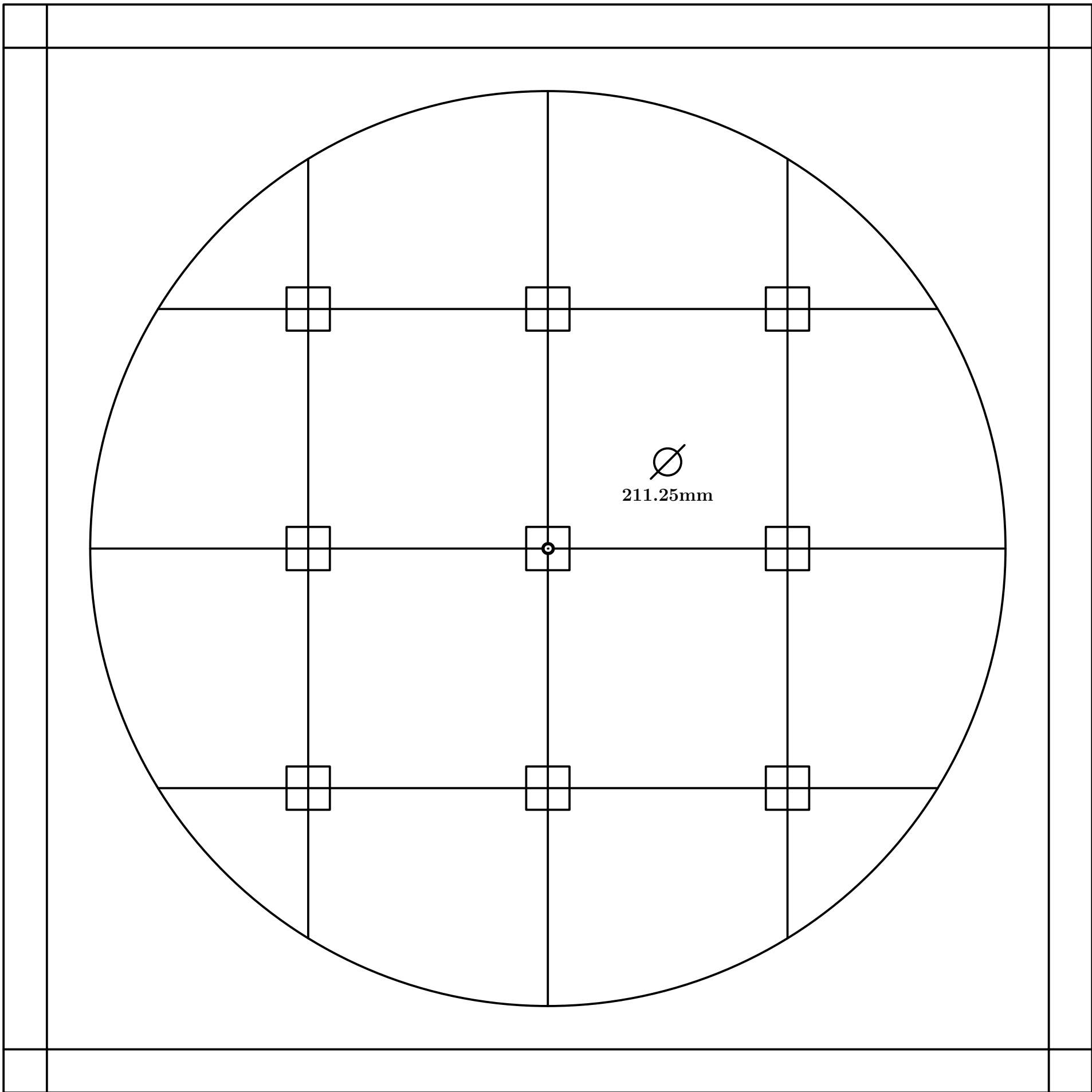

Fig. 446

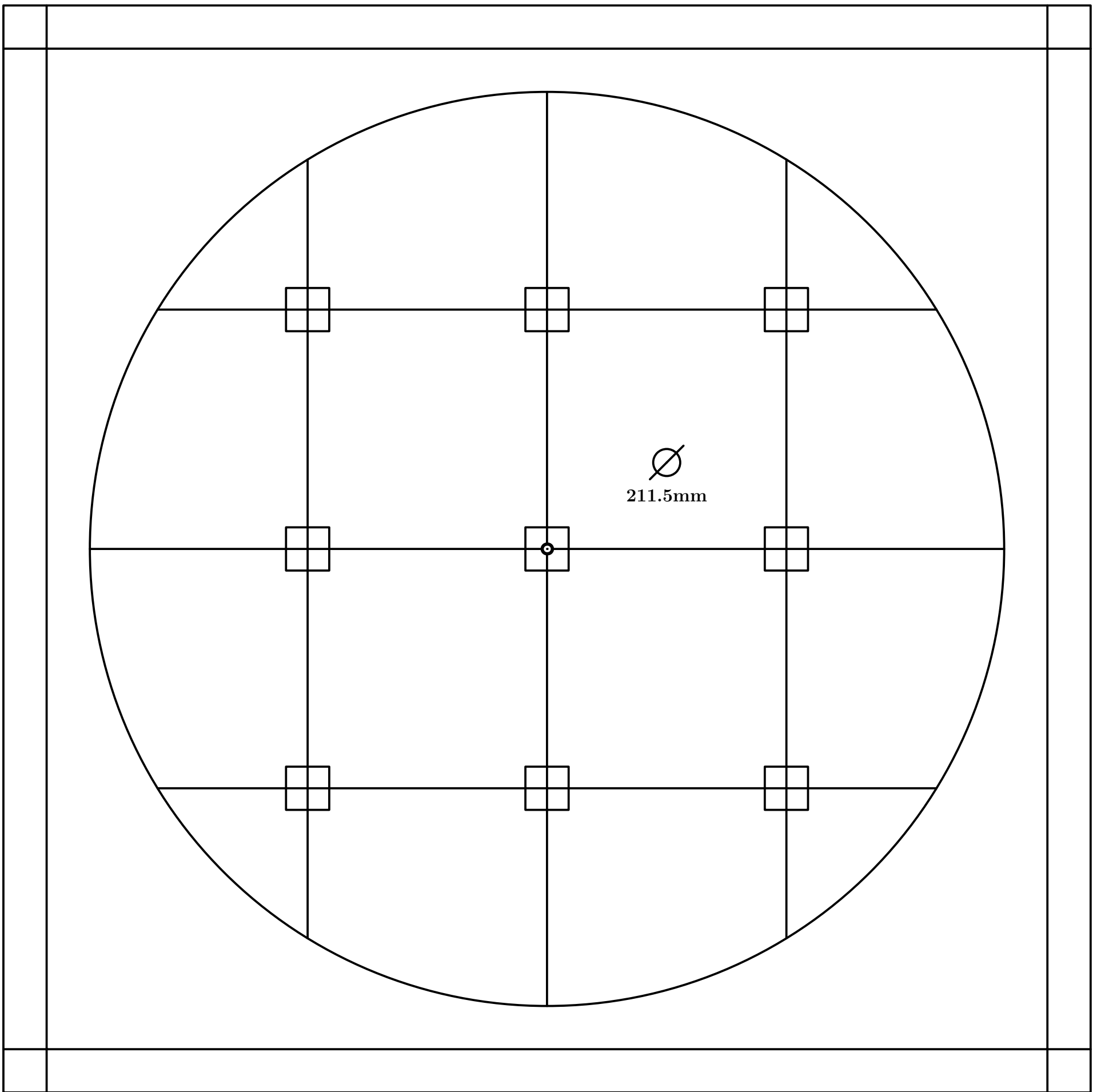

Fig. 447

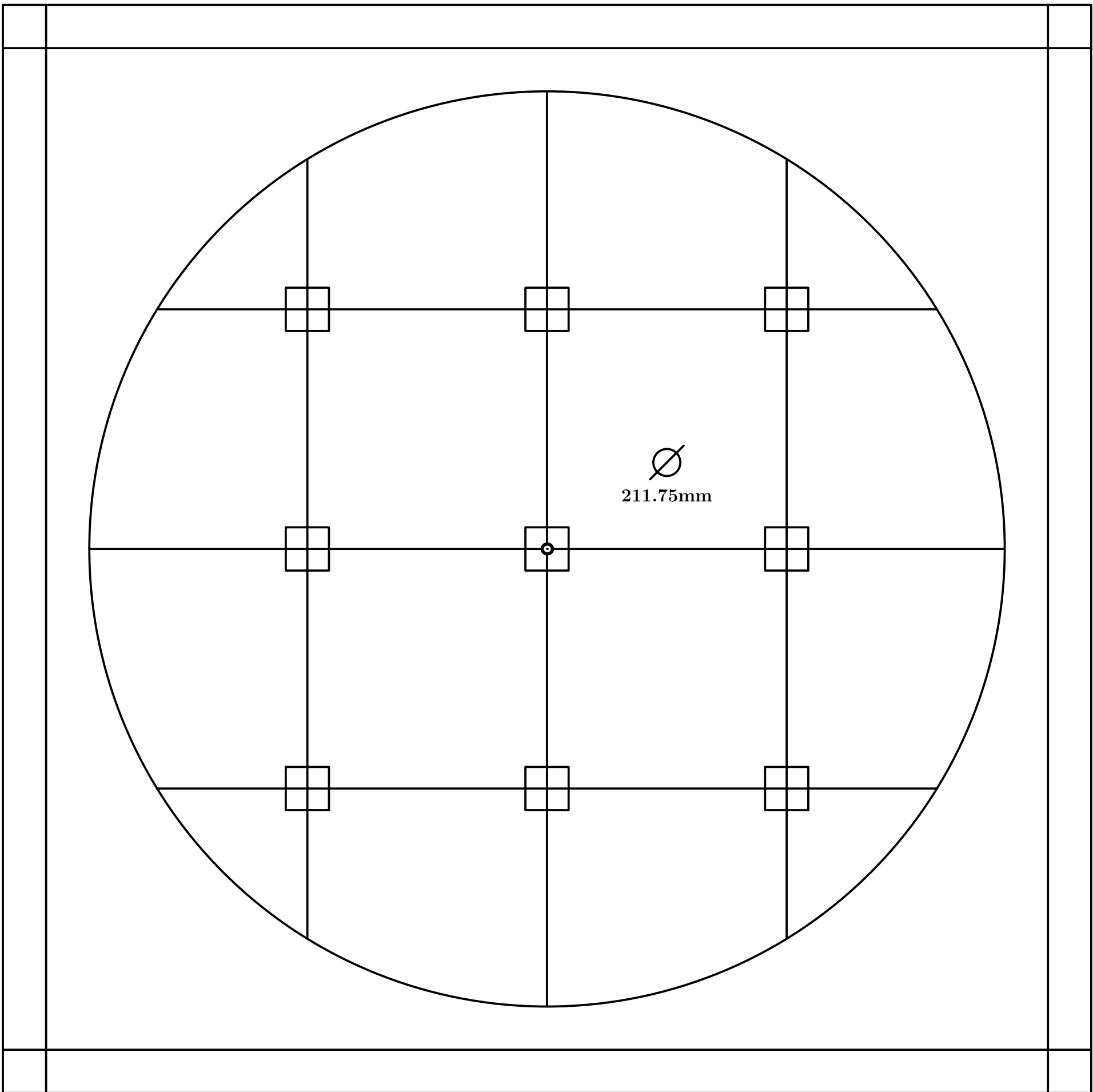

Fig. 448

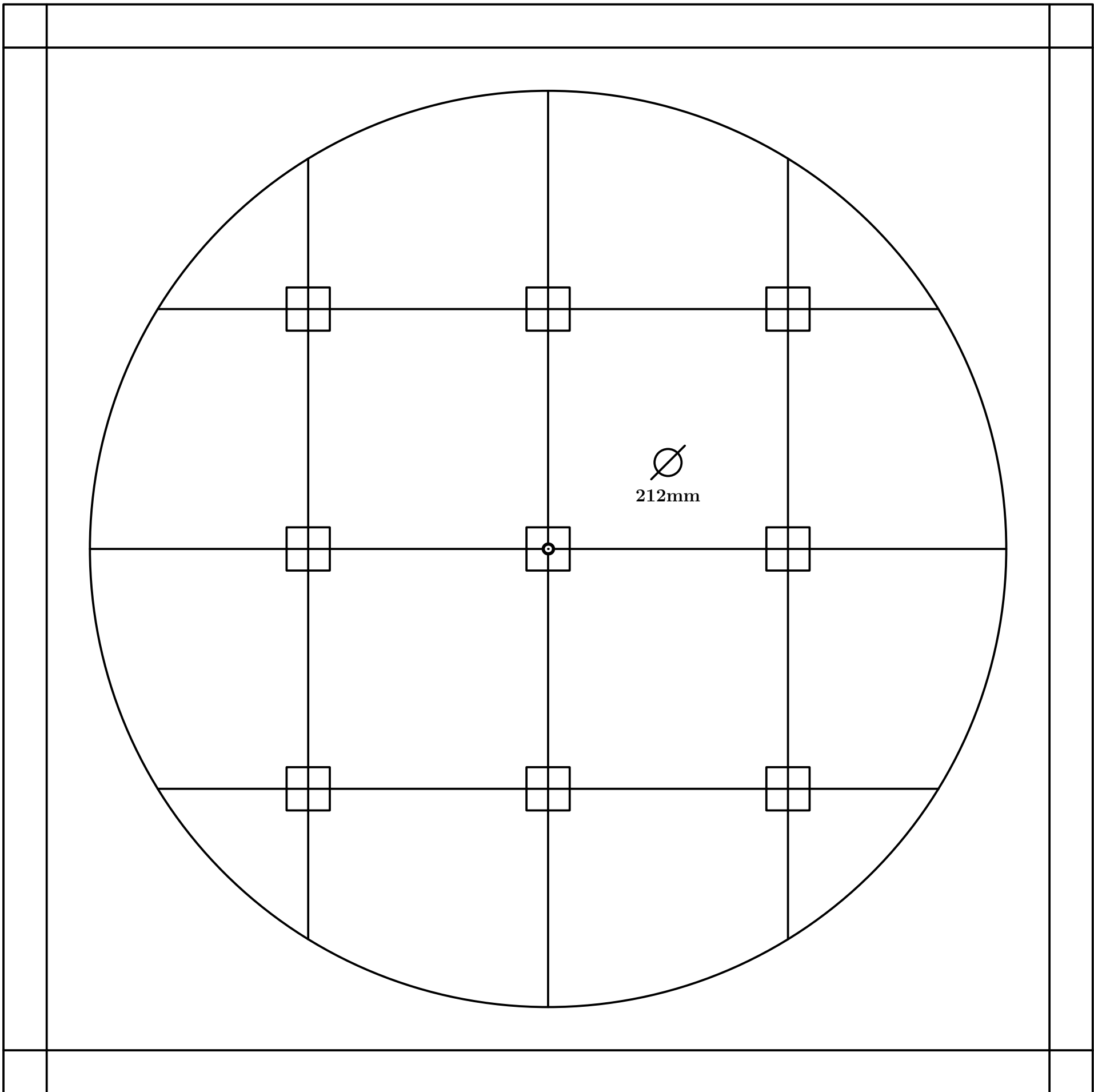

Fig. 449

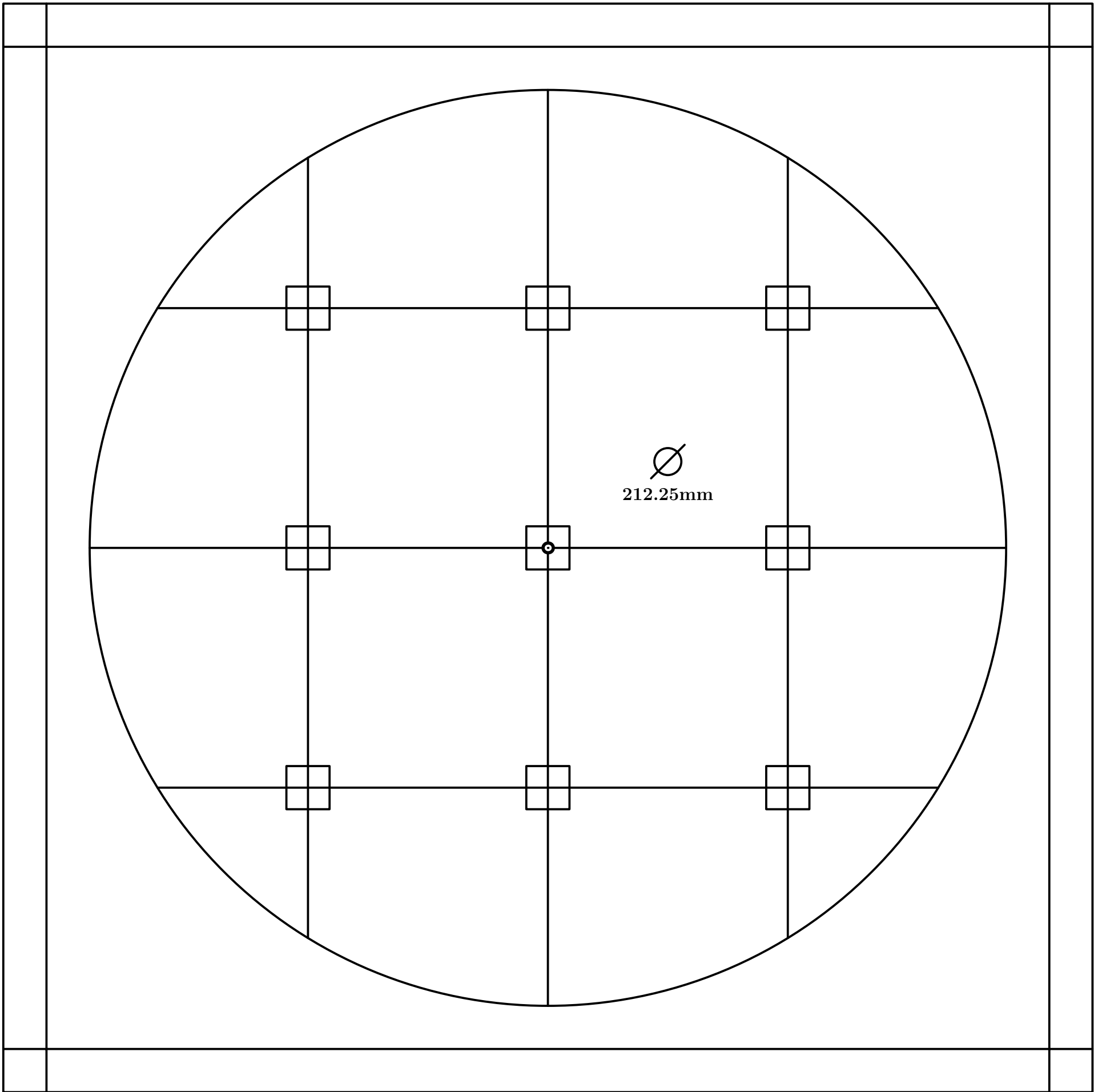

Fig. 450

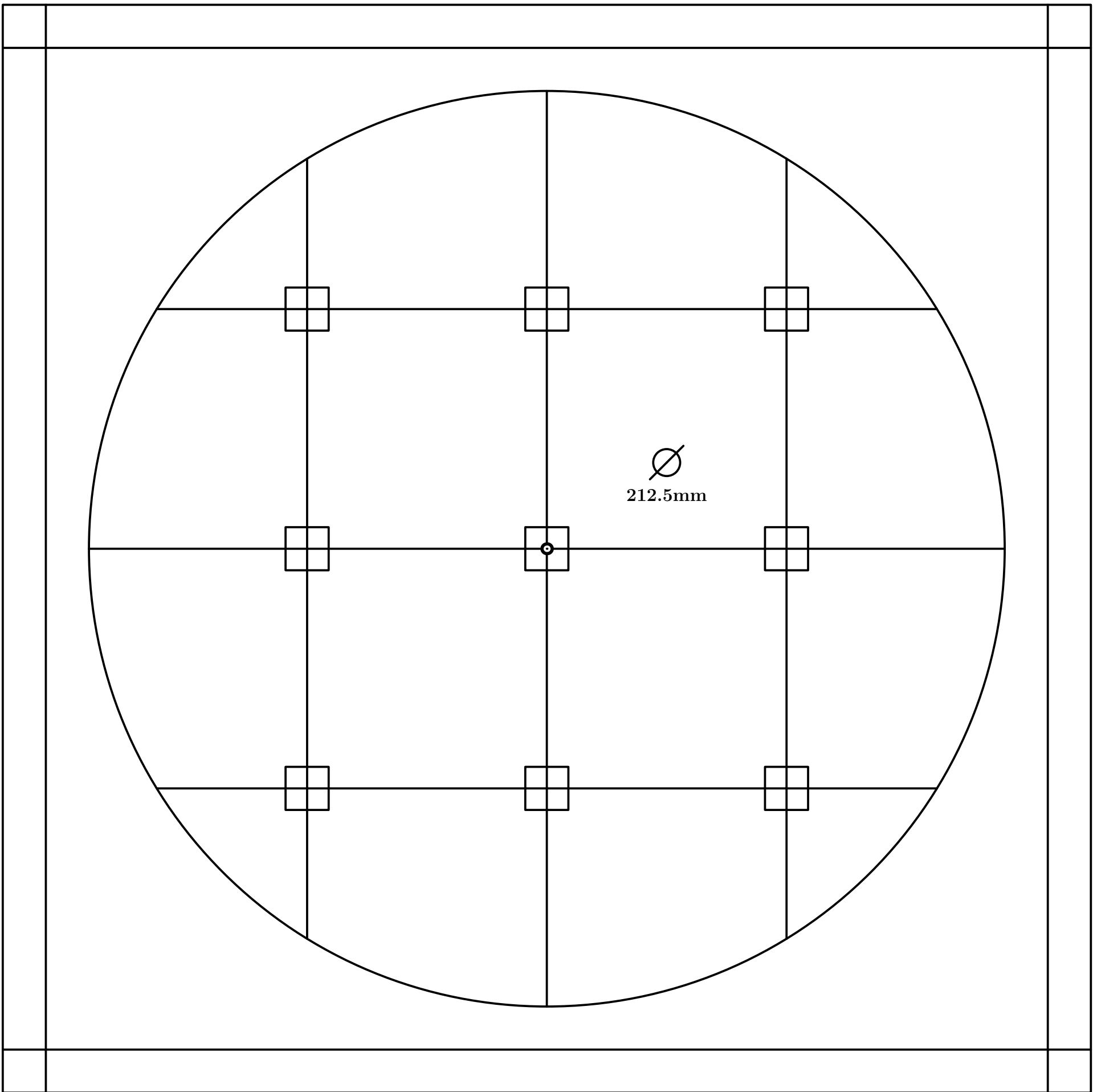

Fig. 451

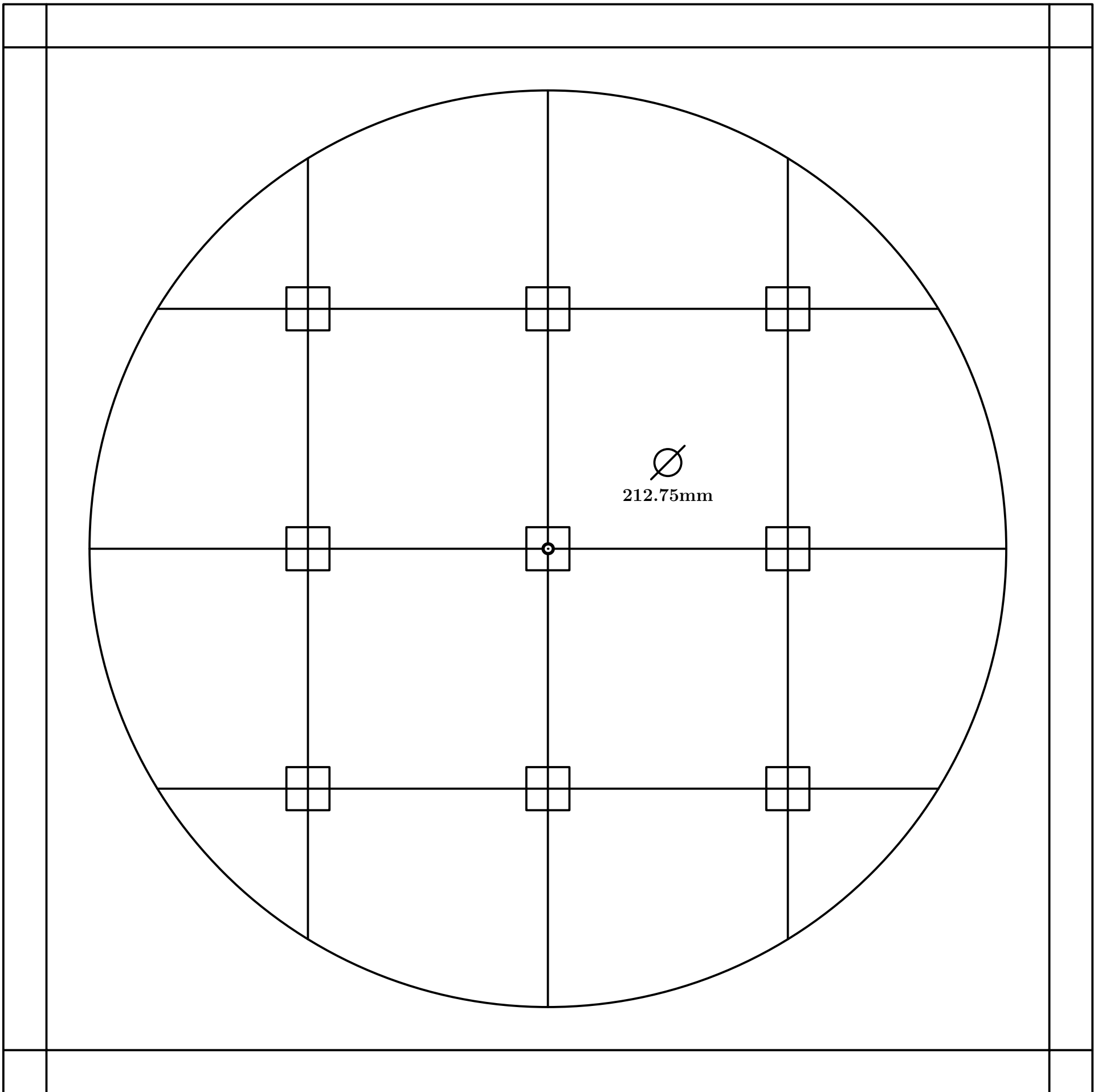

Fig. 452

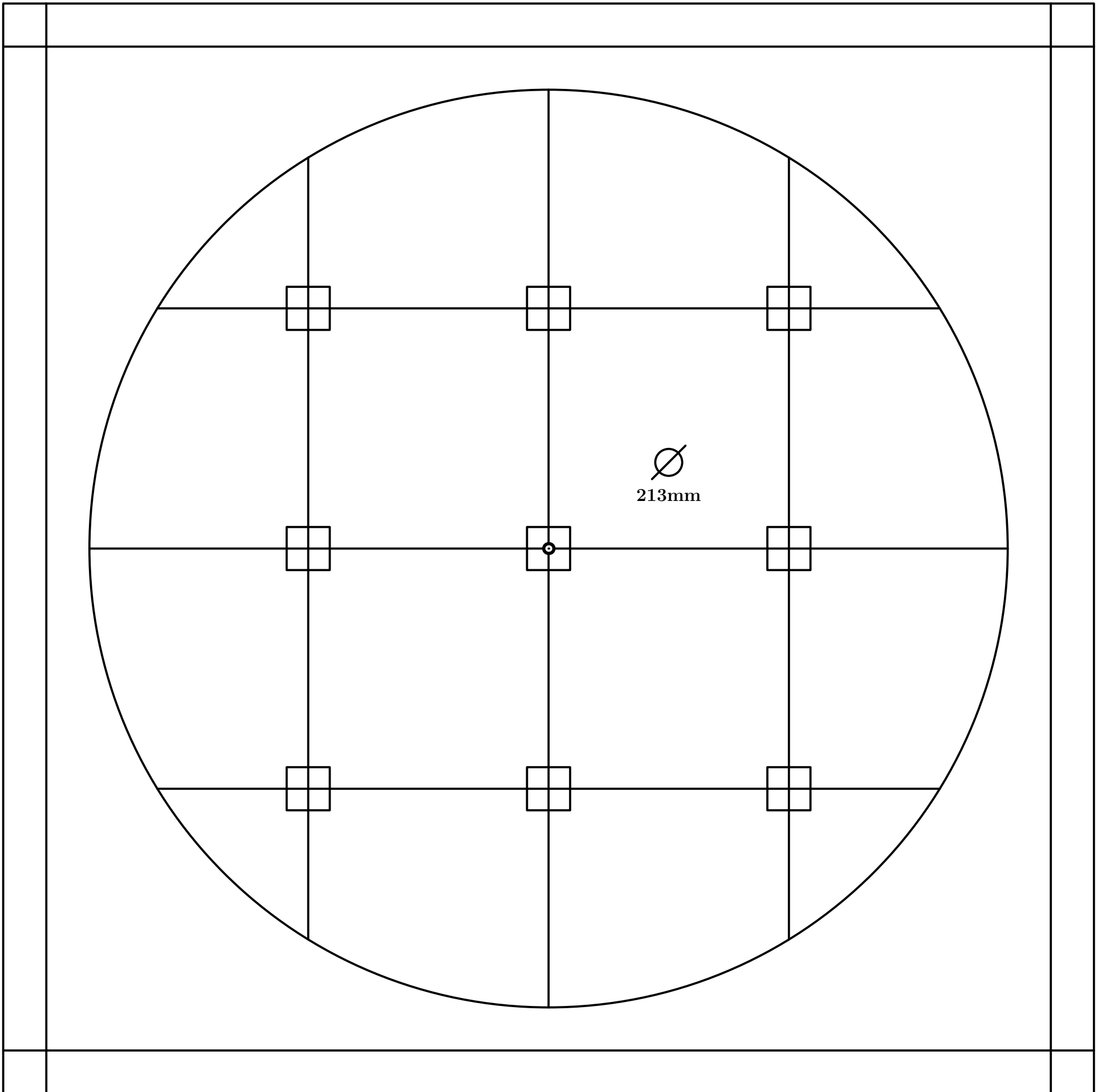

Fig. 453

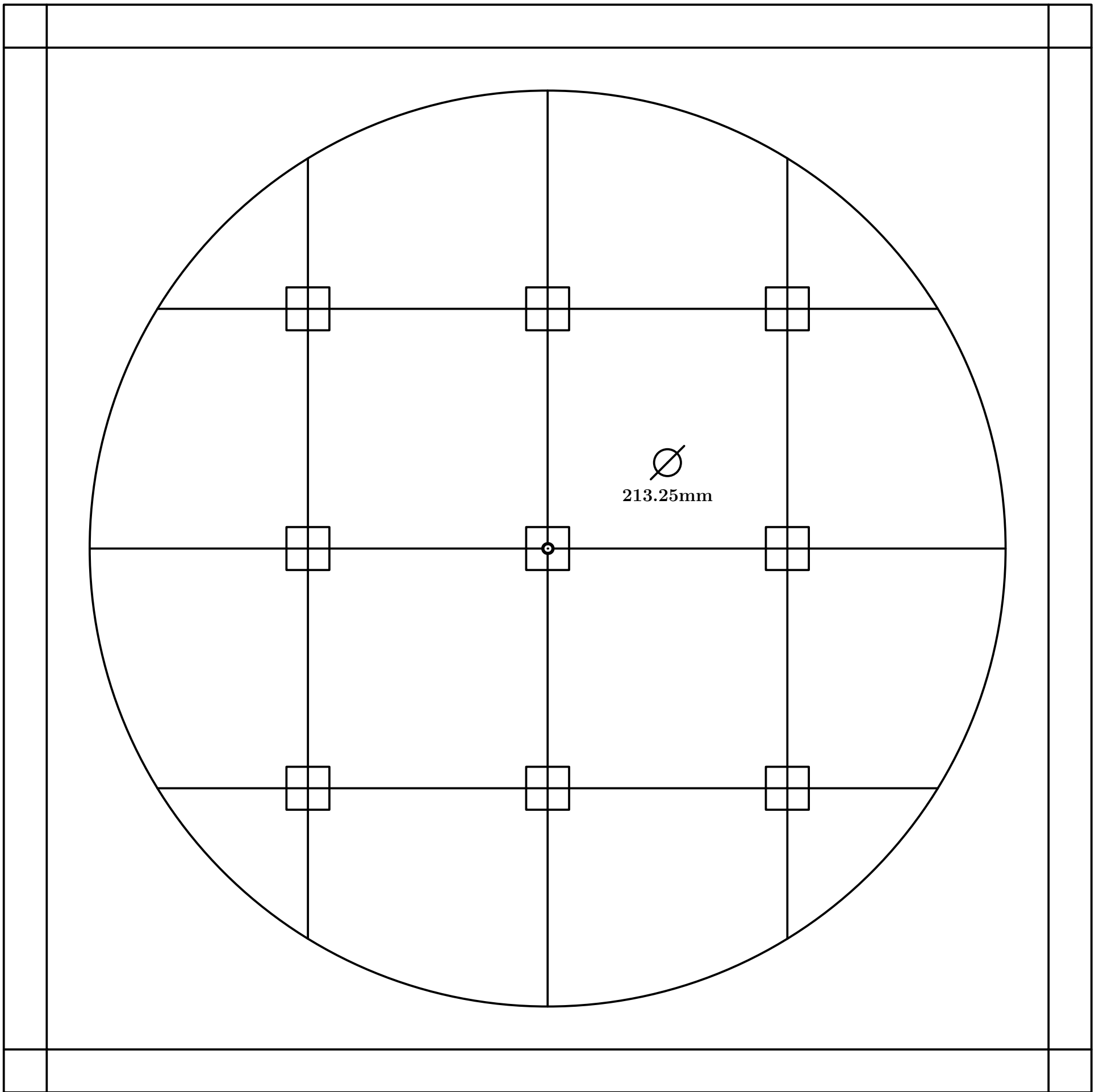

Fig. 454

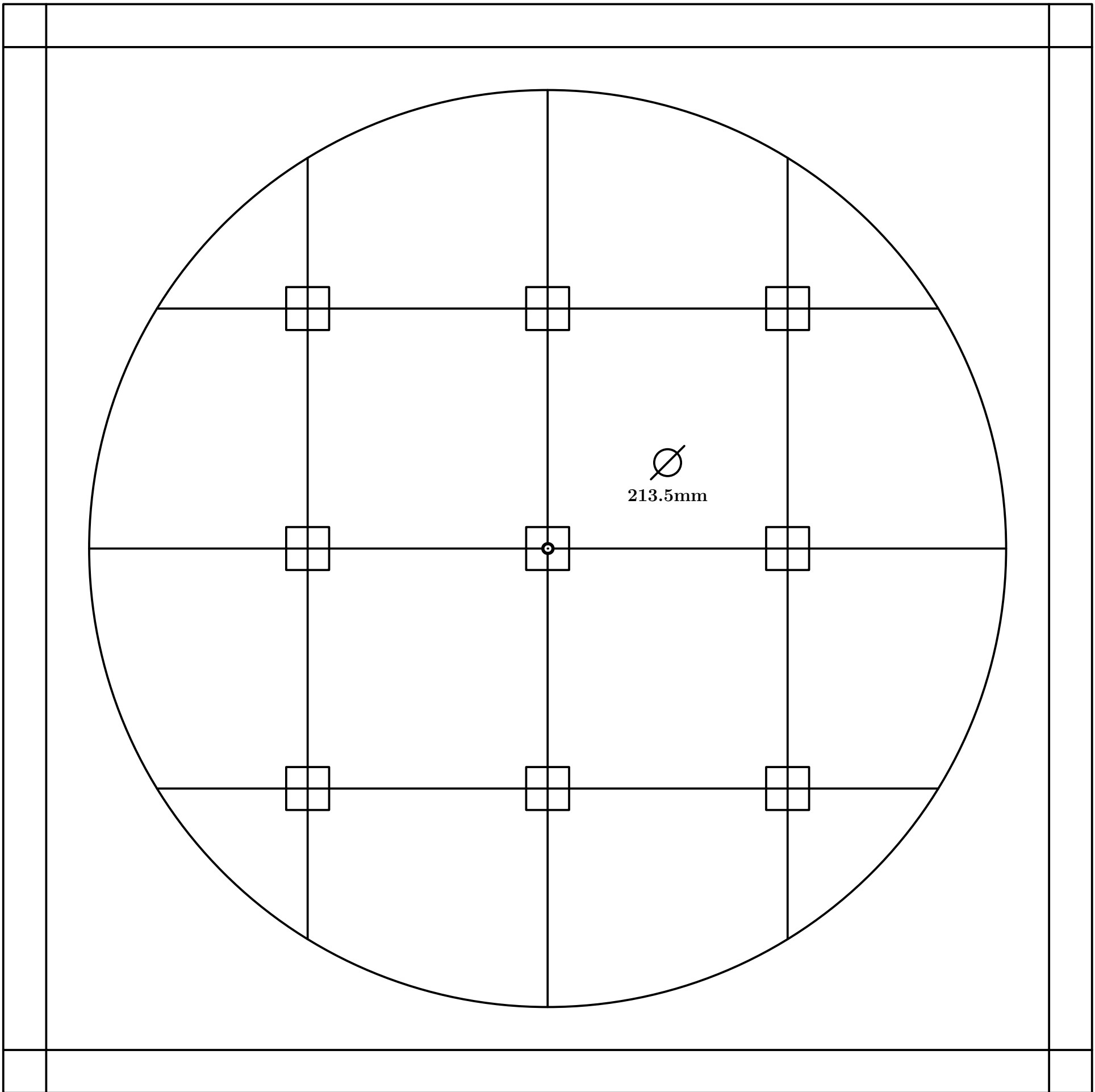

Fig. 455

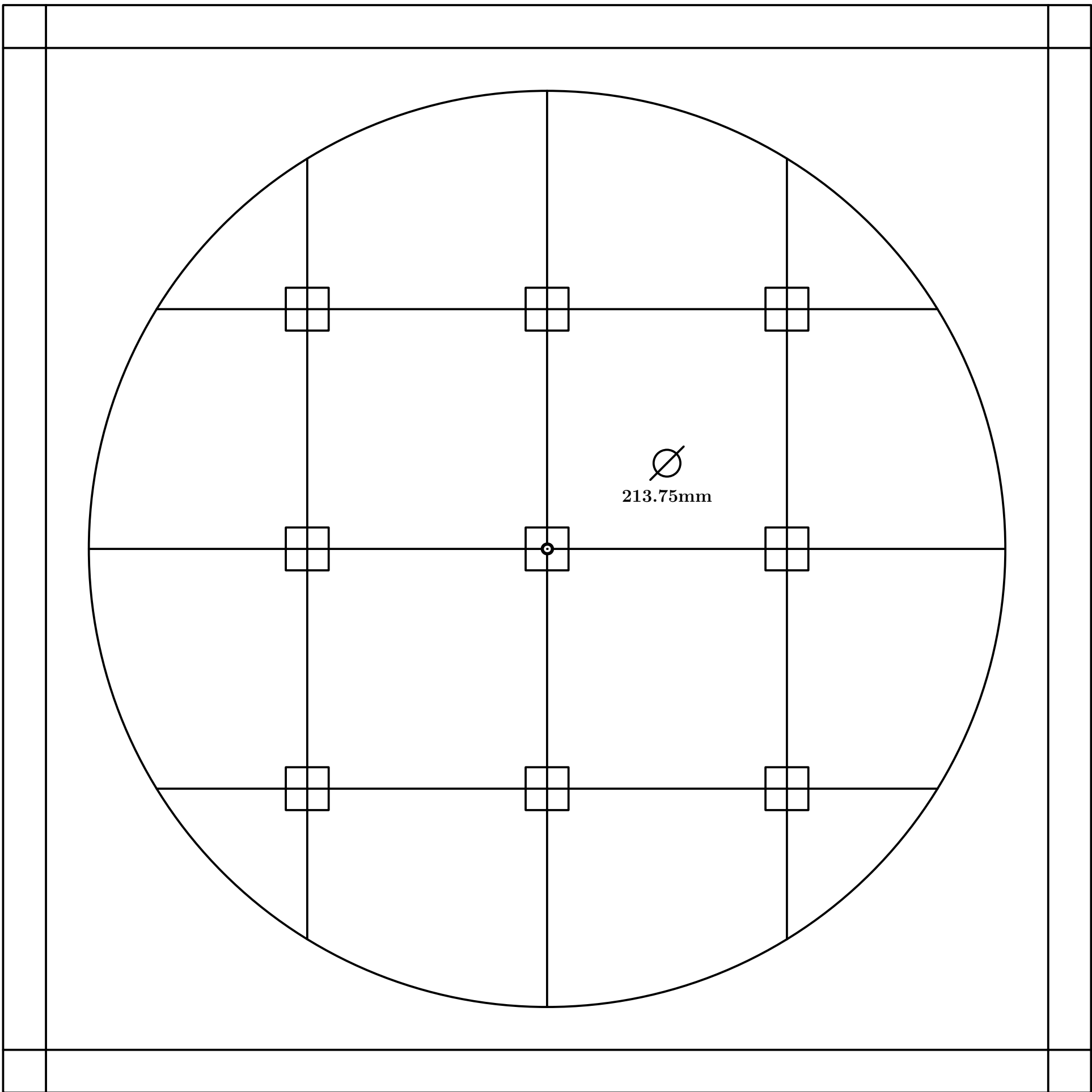

Fig. 456

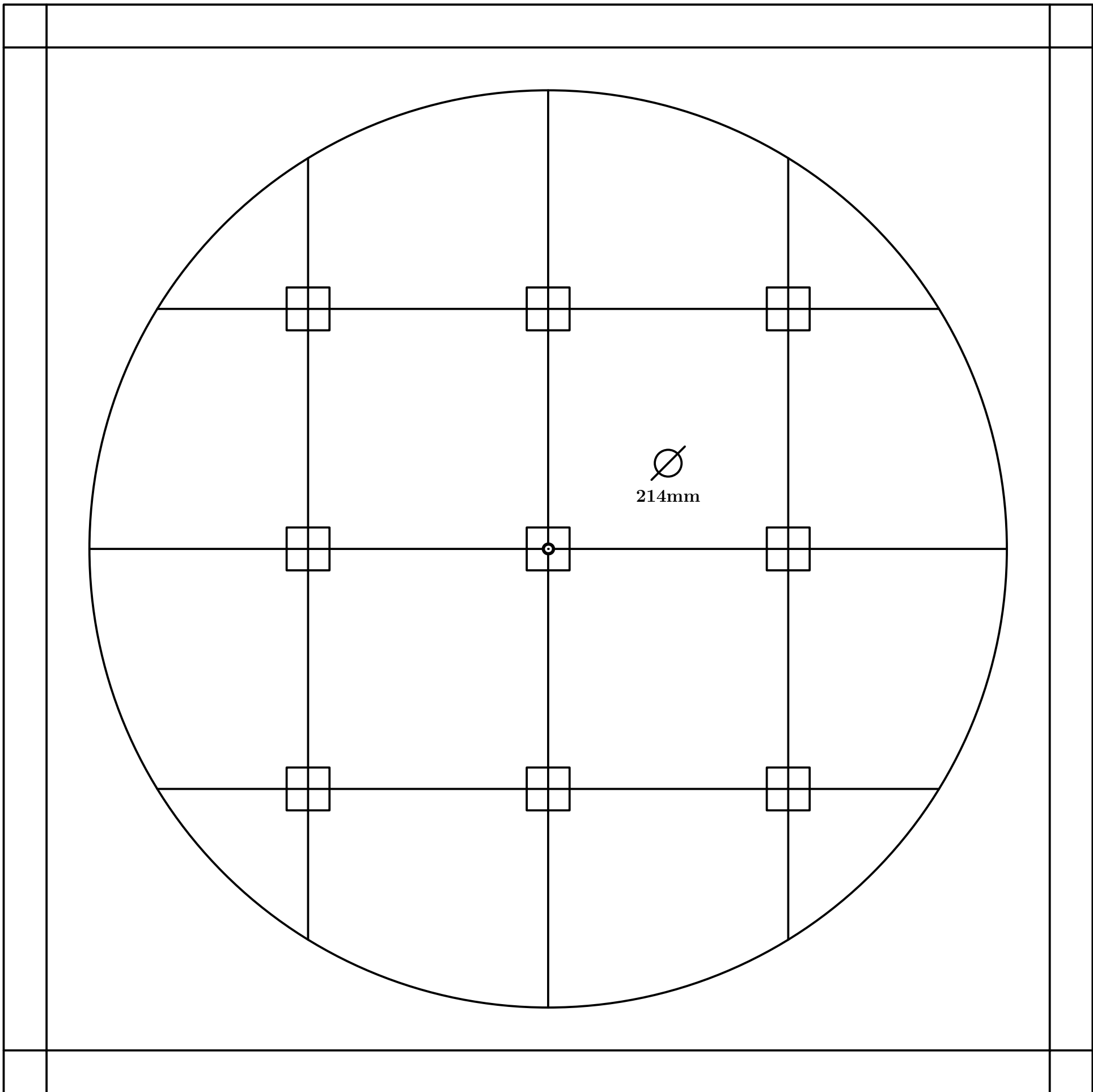

Fig. 457

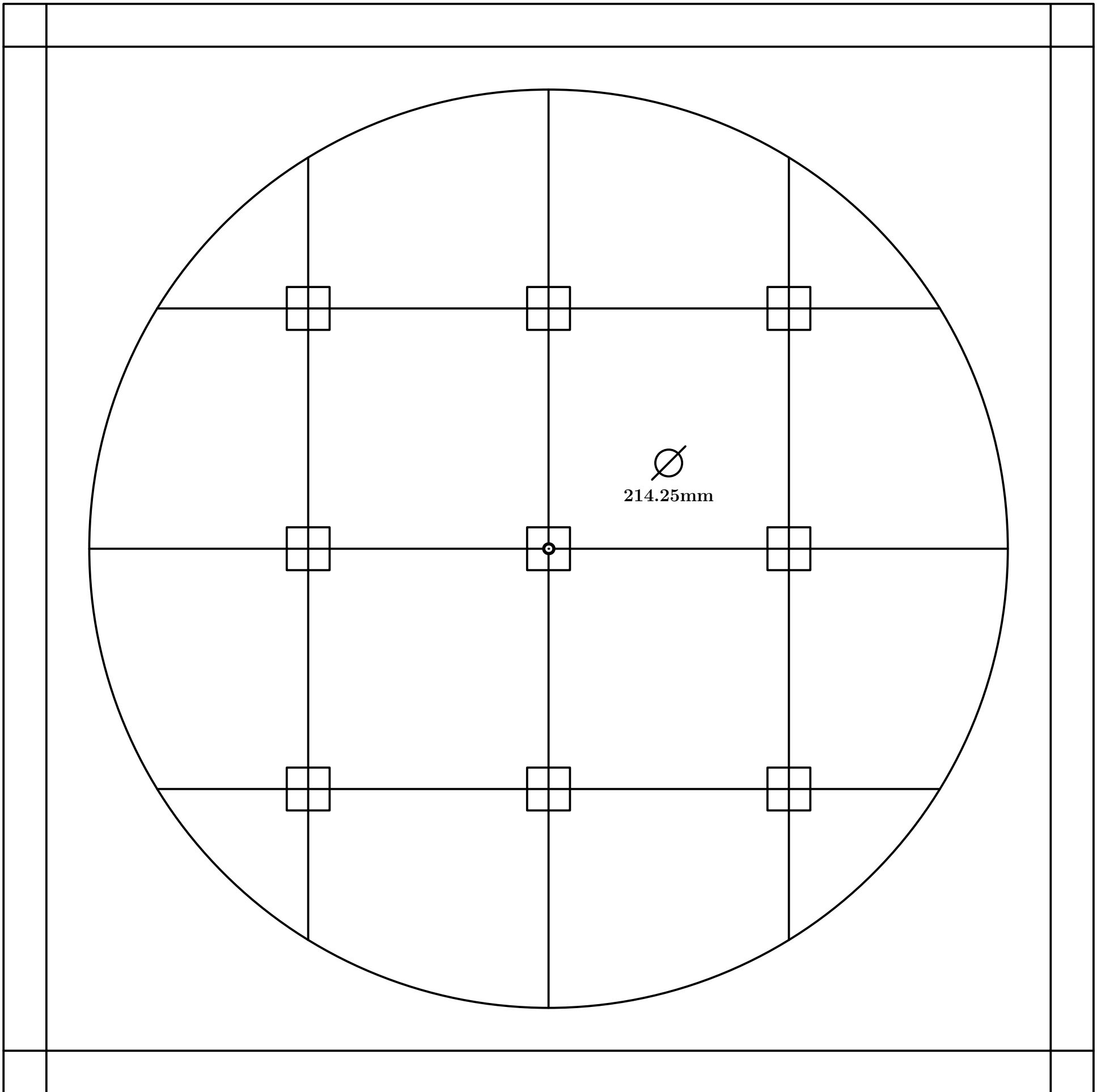

Fig. 458

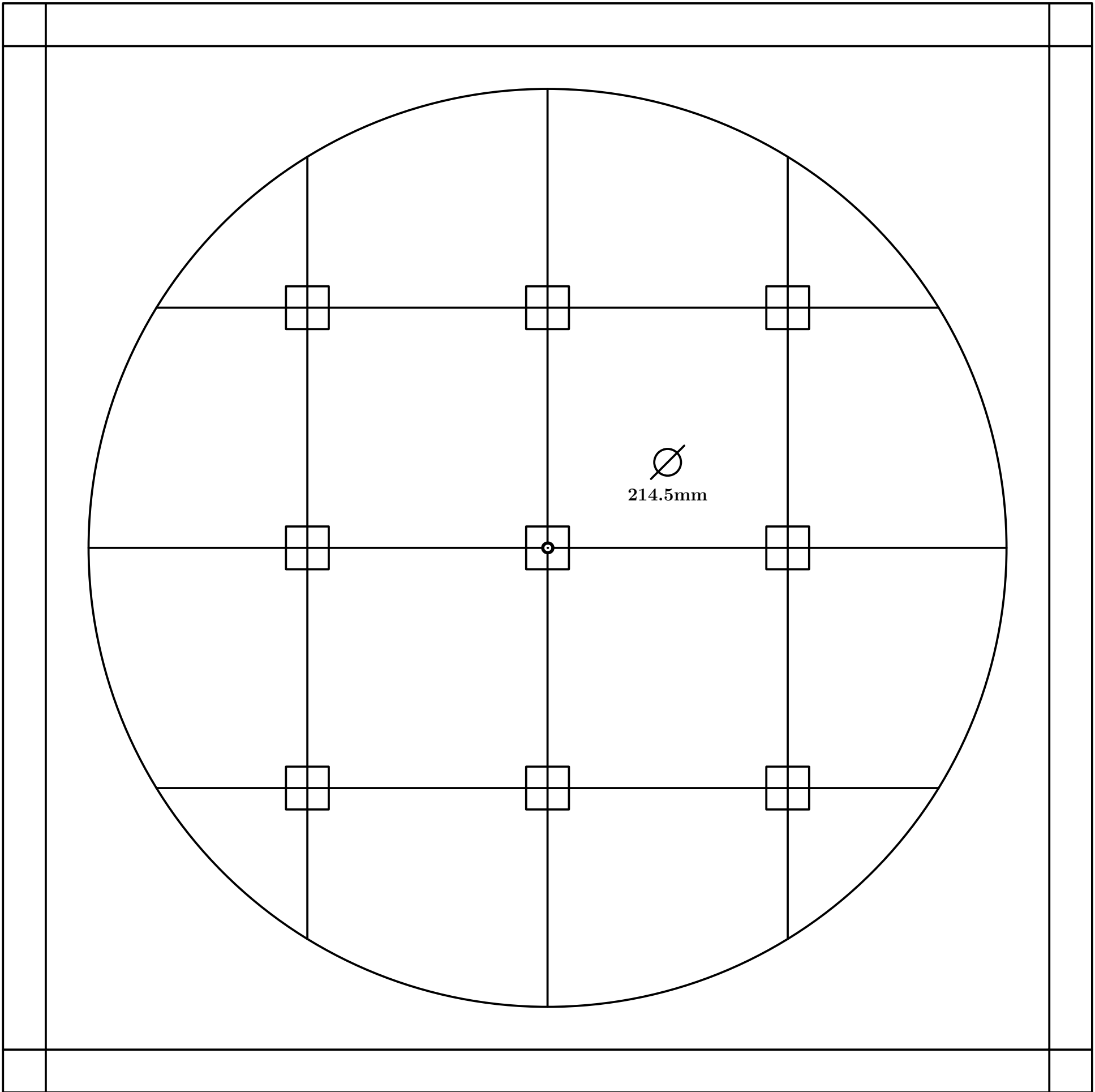

Fig. 459

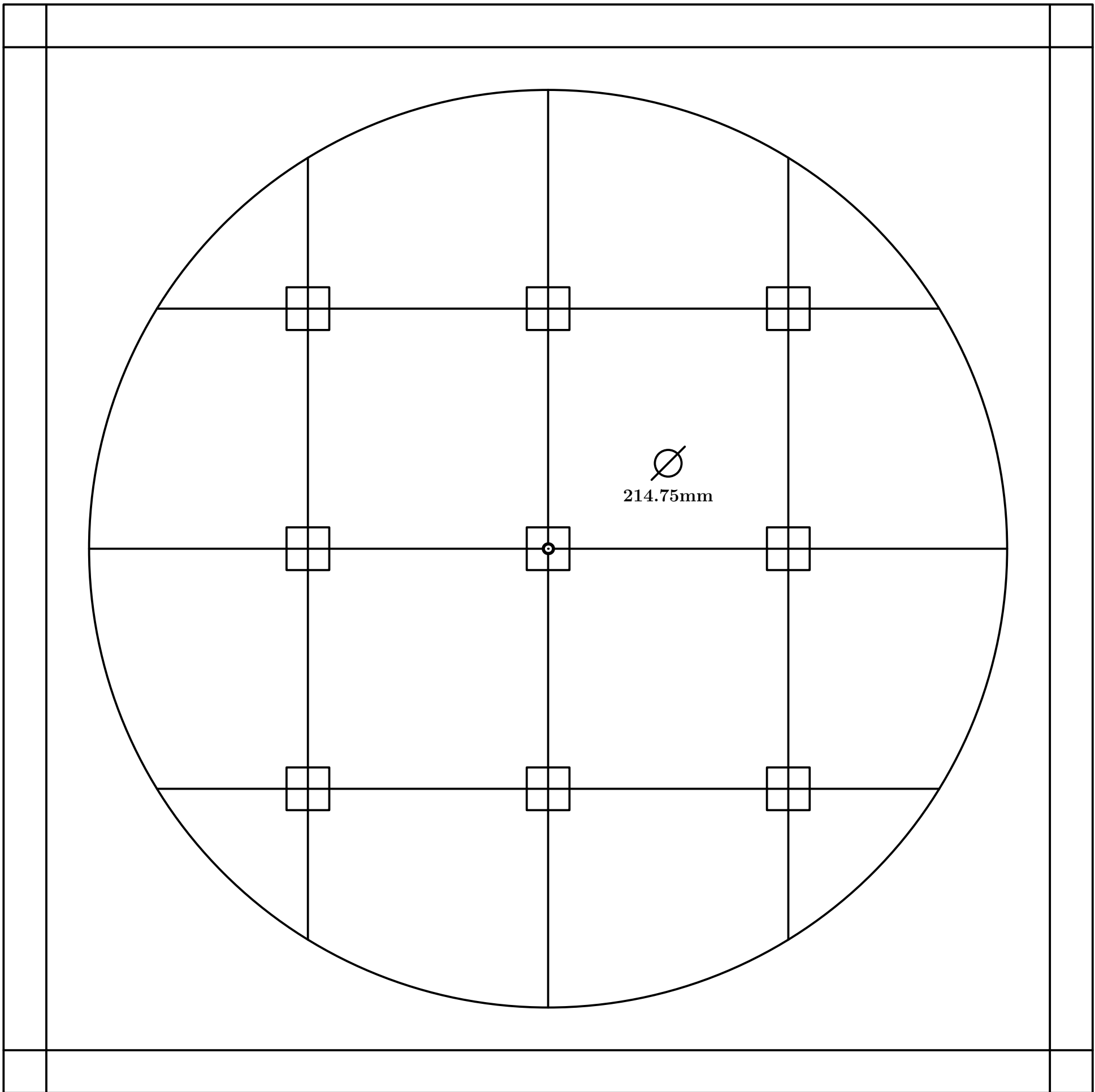

Fig. 460

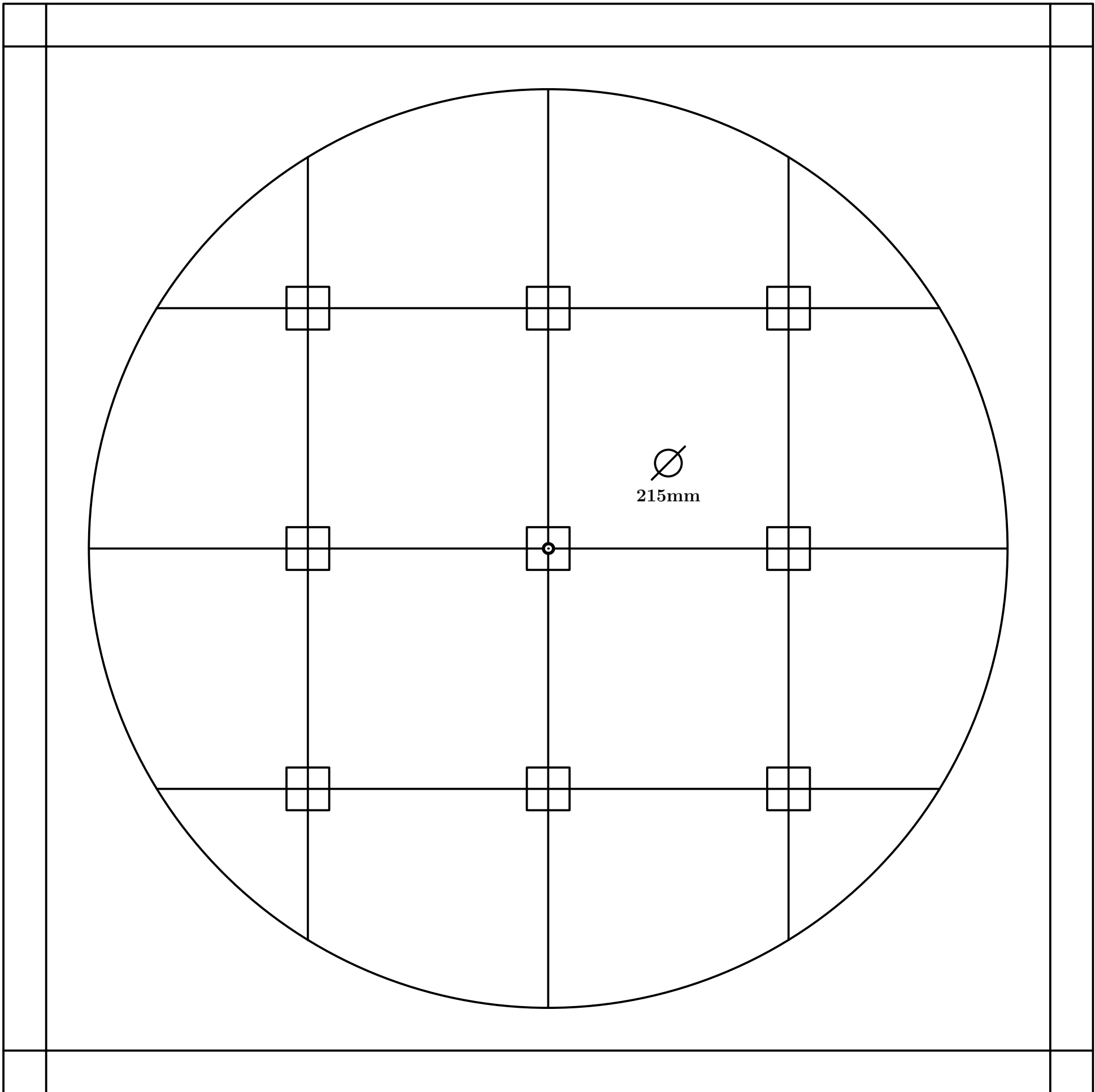

Fig. 461

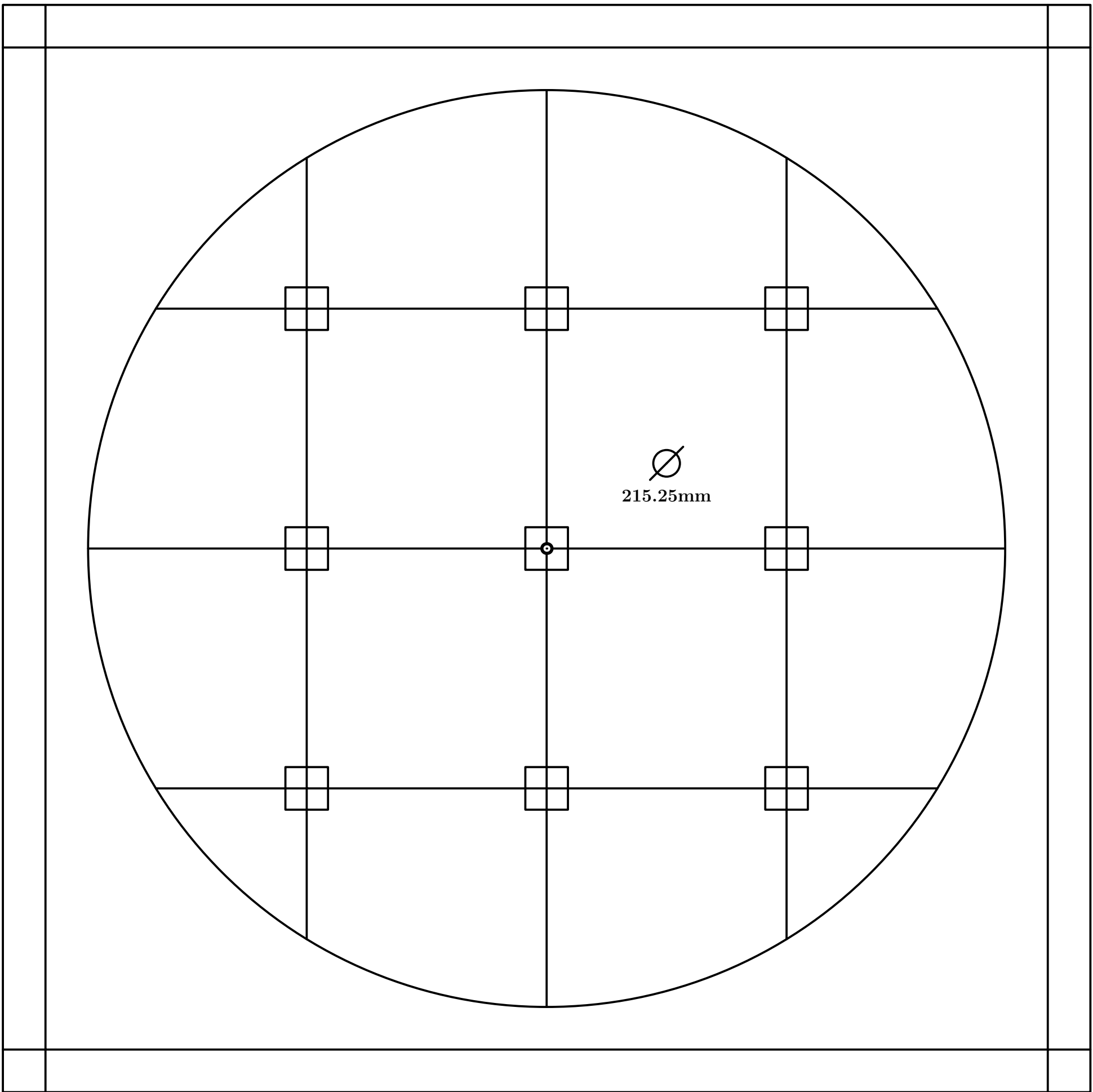

Fig. 462

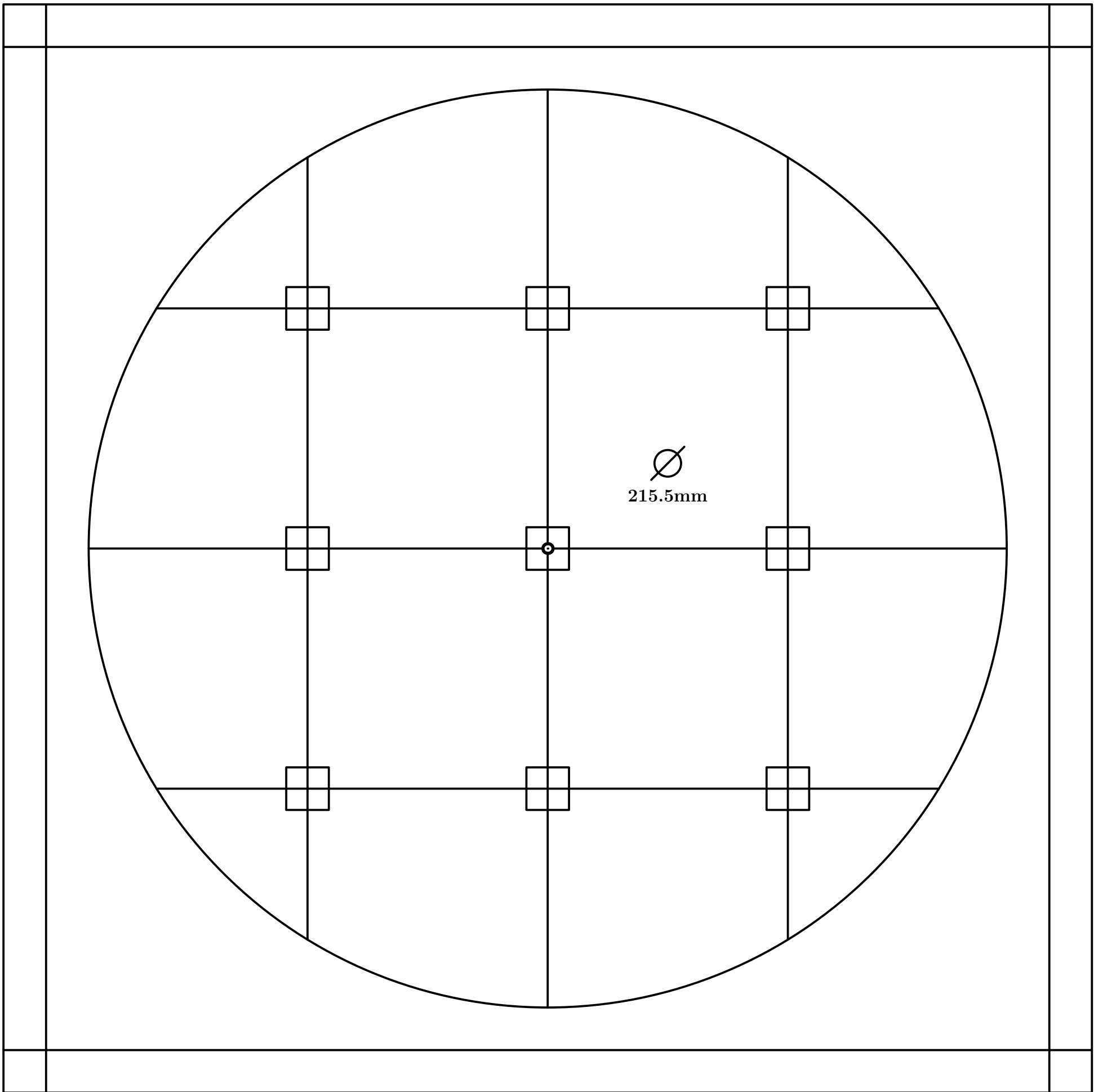

Fig. 463

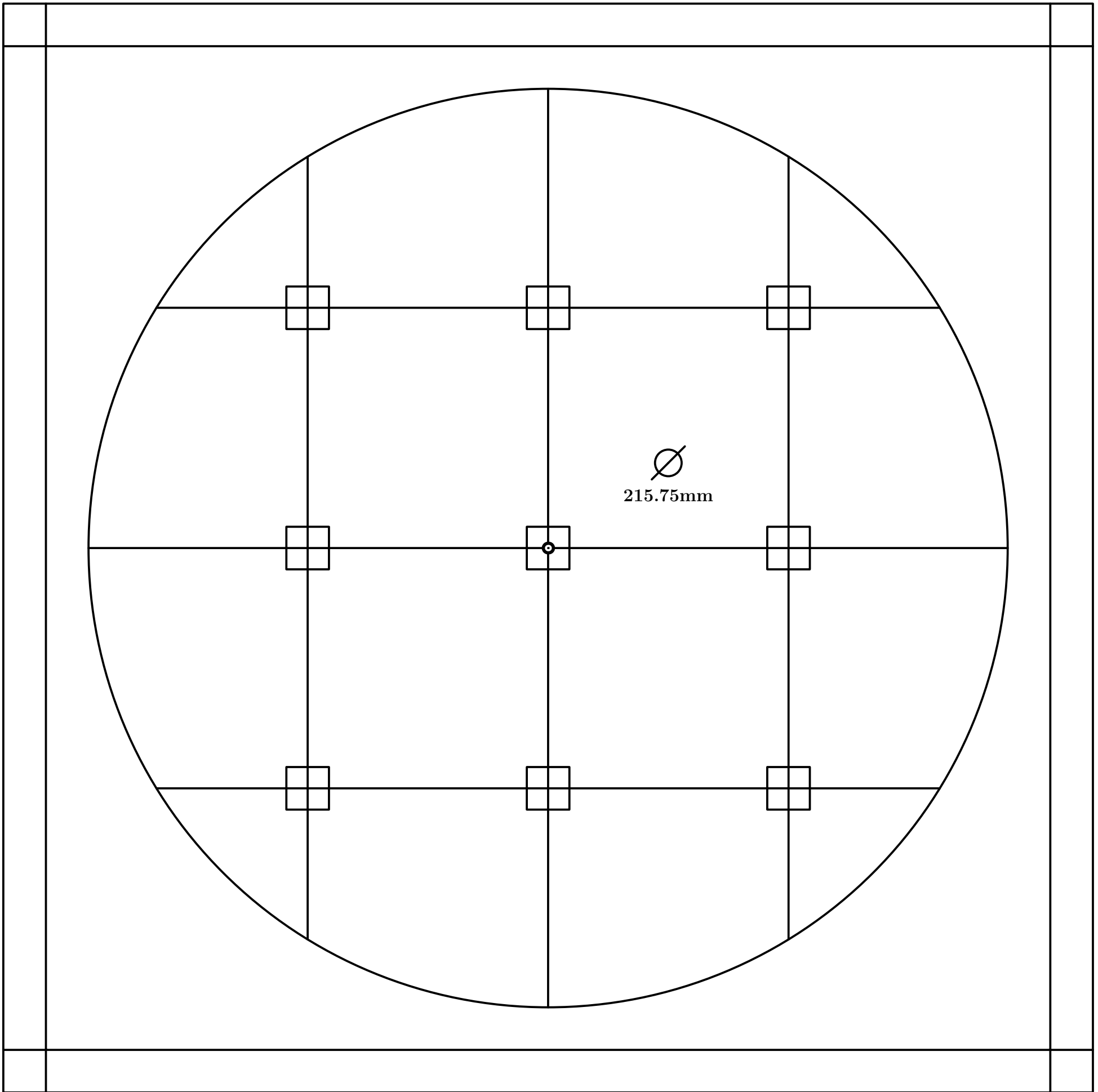

Fig. 464

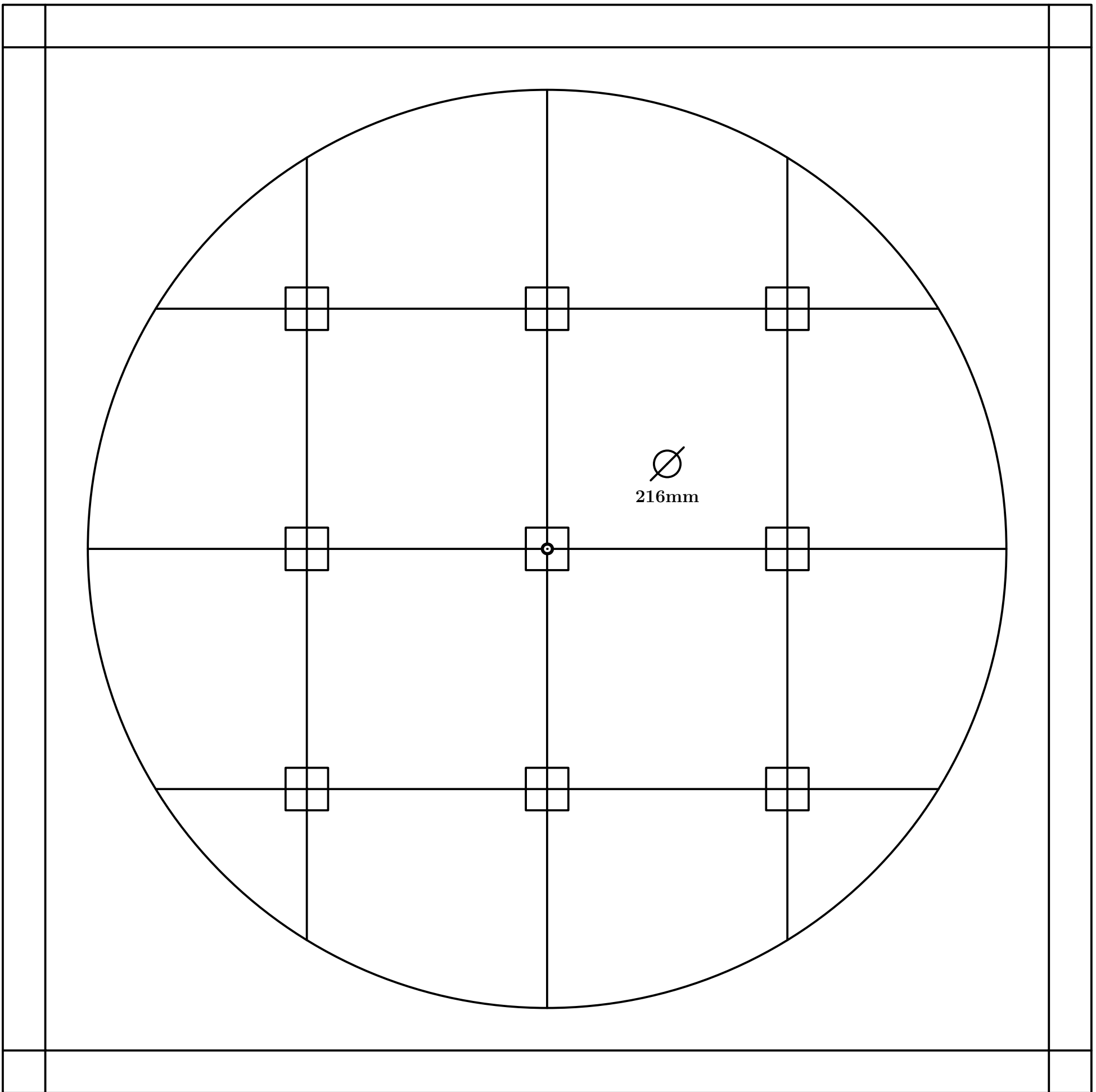

Fig. 465

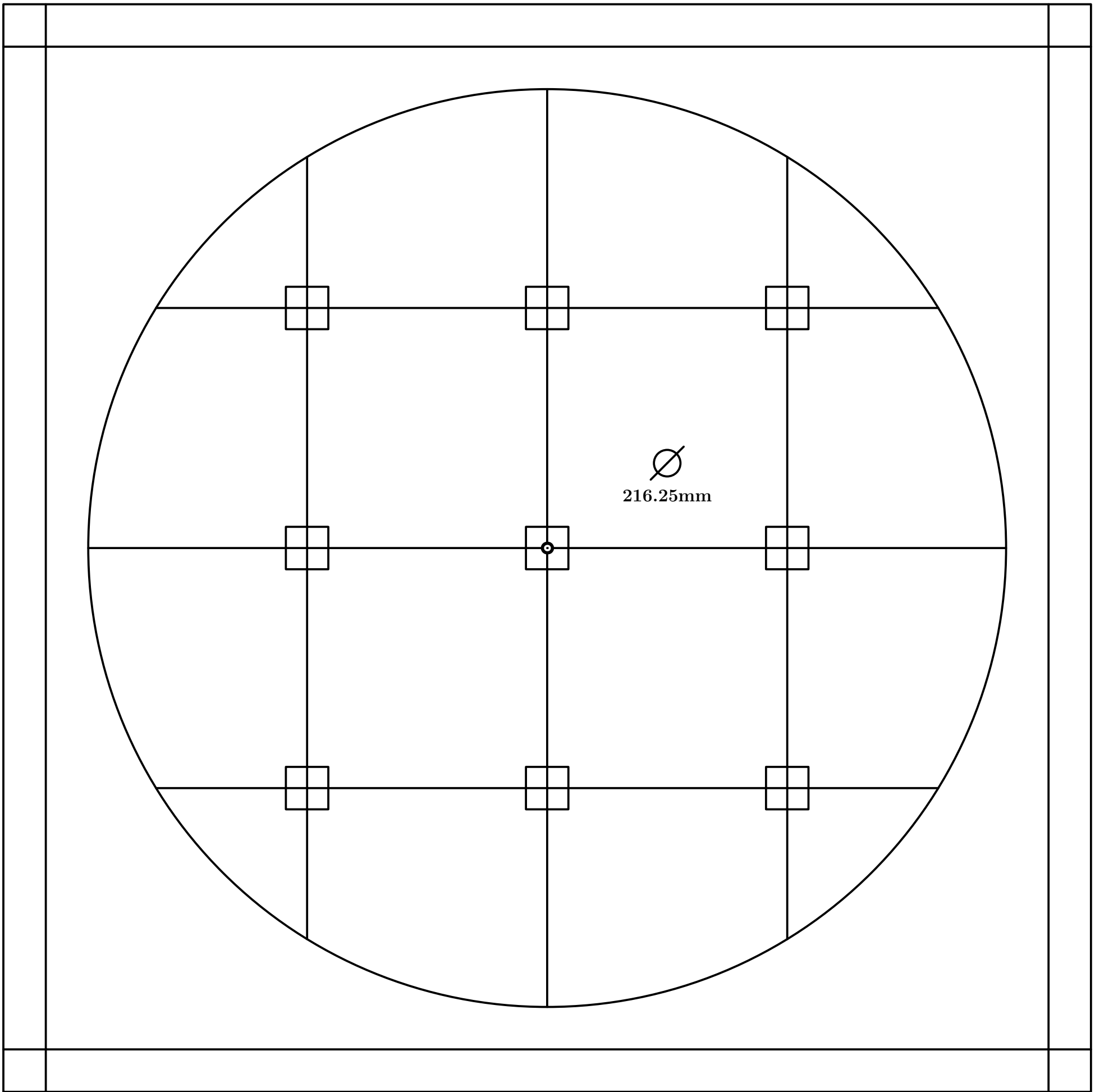

Fig. 466

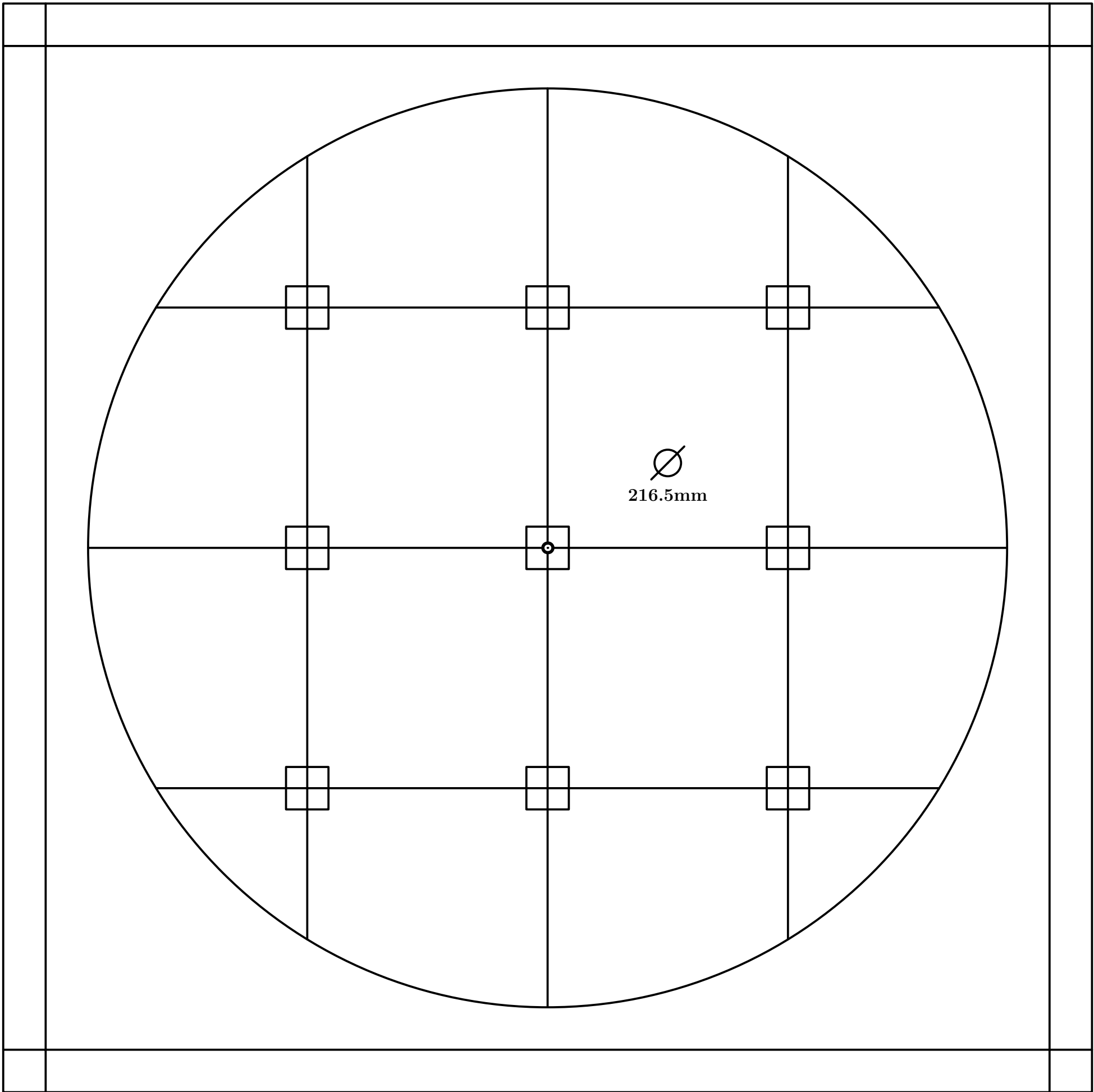

Fig. 467

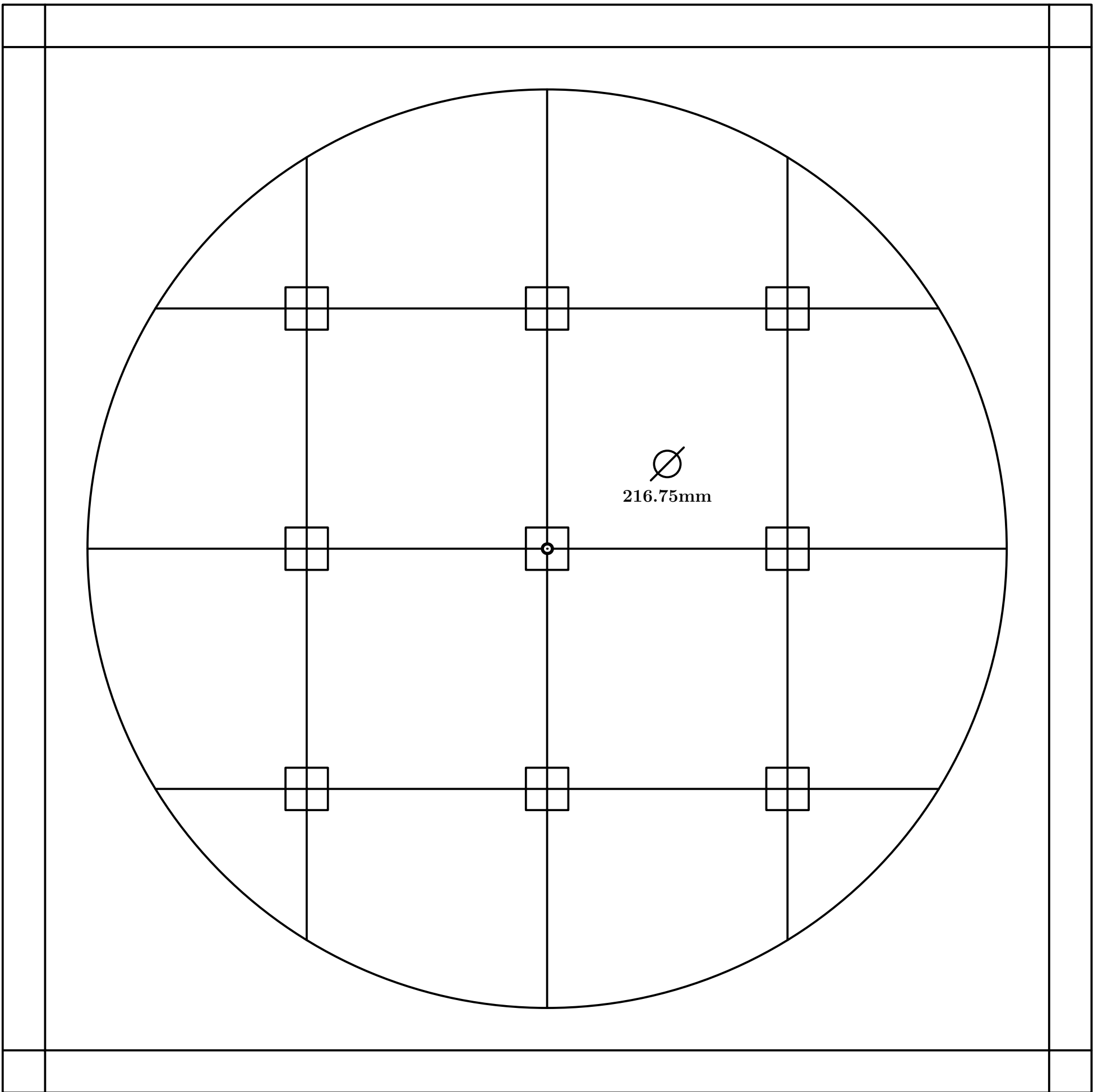

Fig. 468

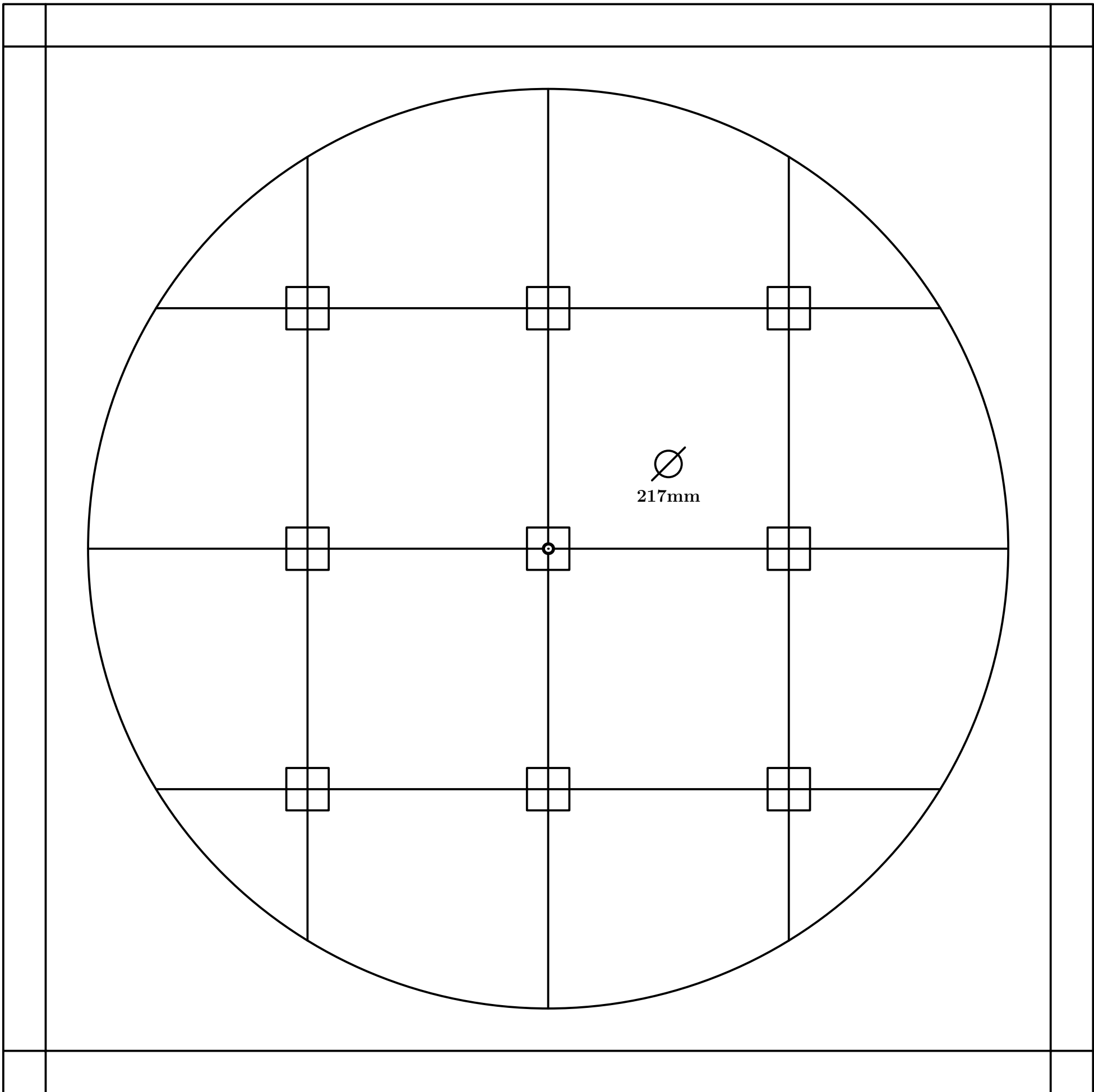

Fig. 469

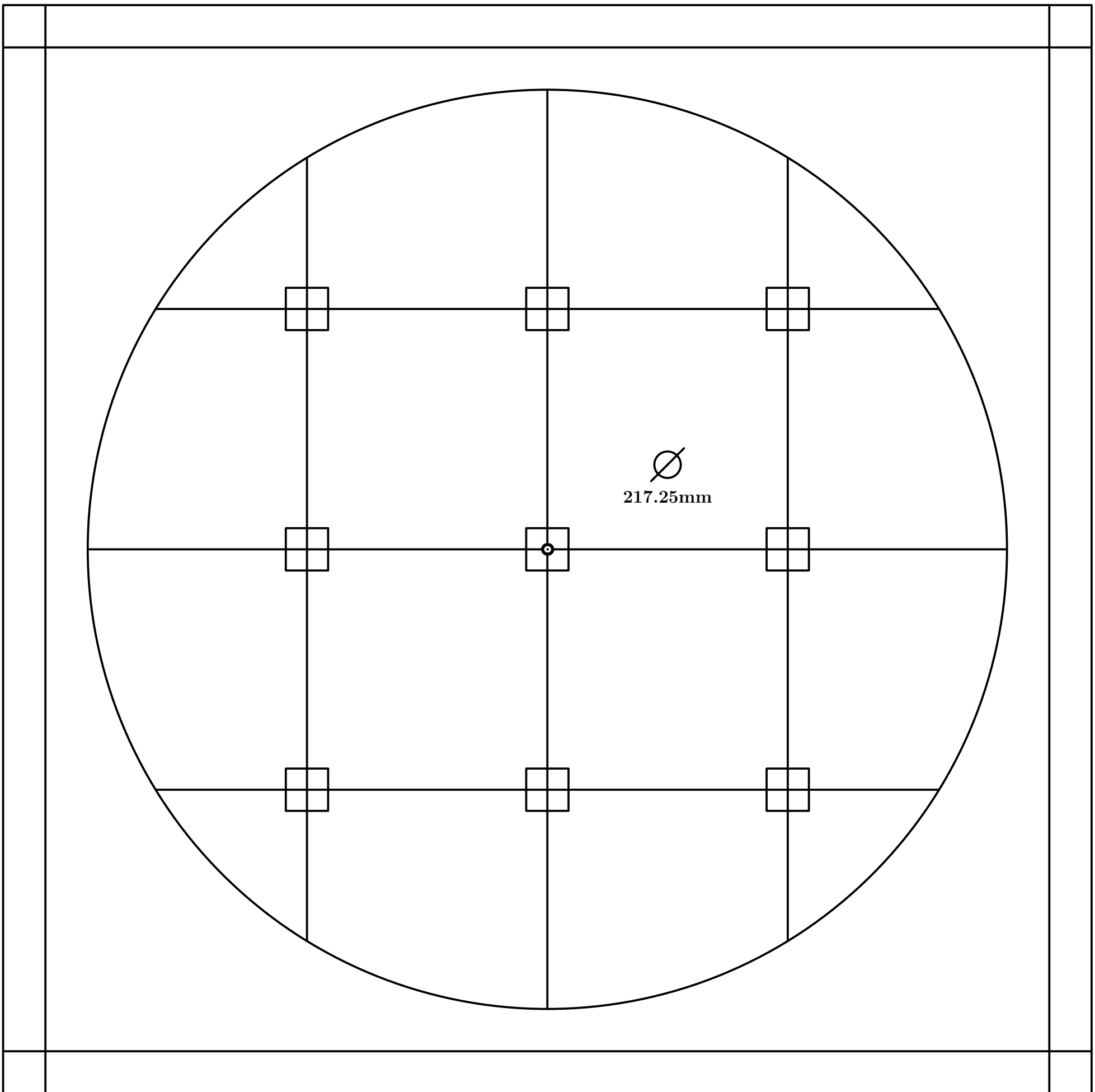

Fig. 470

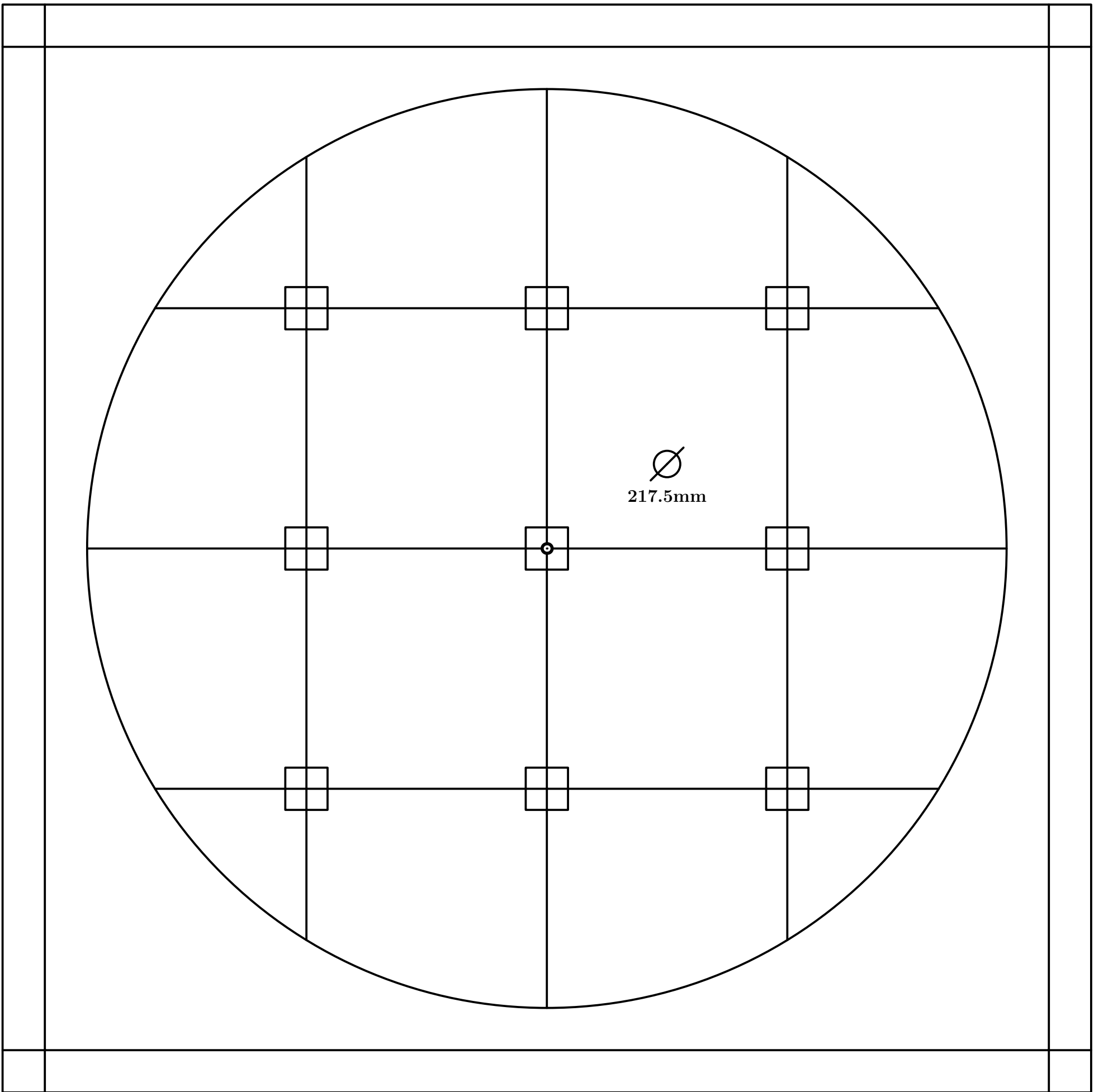

Fig. 471

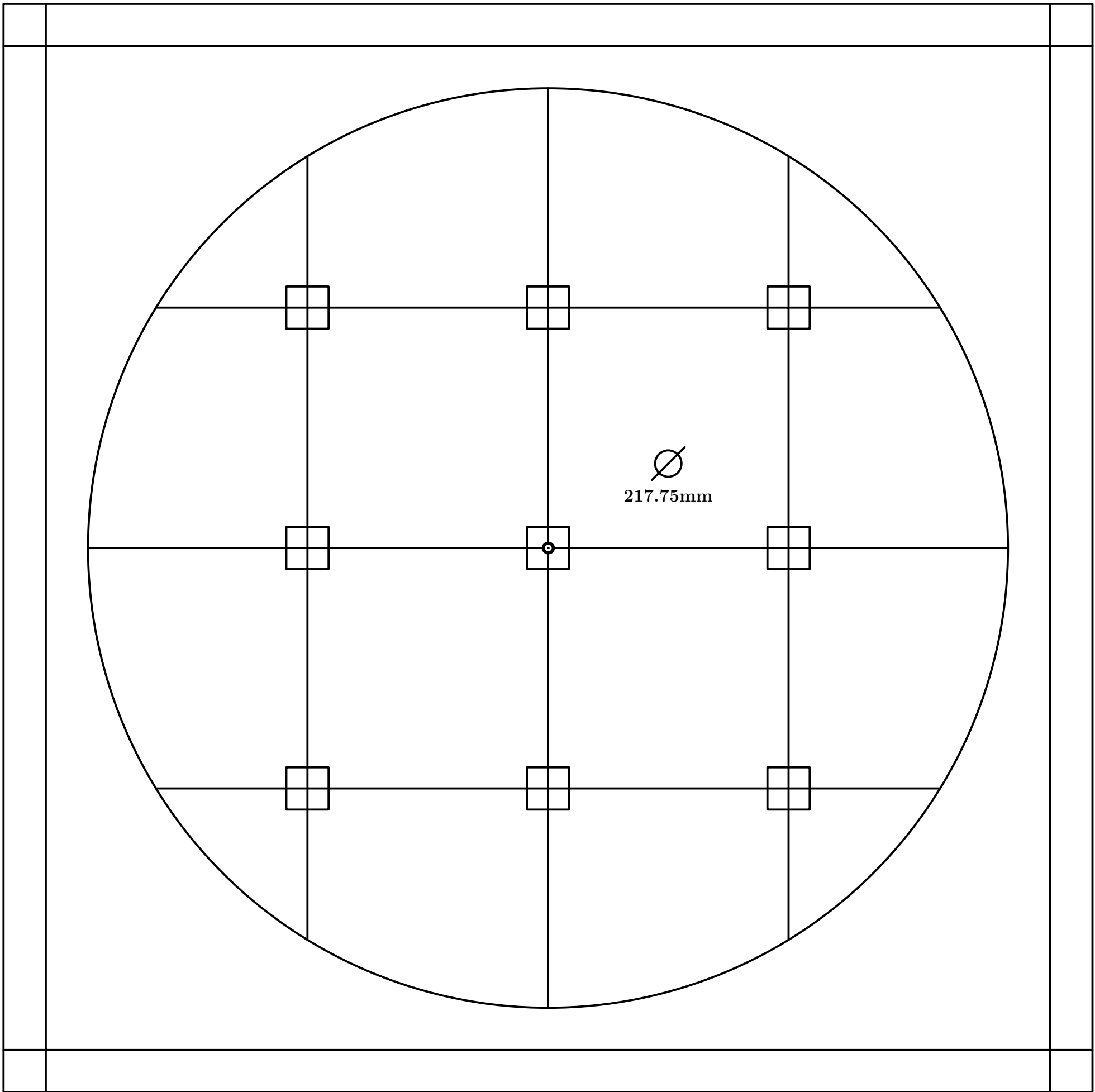

Fig. 472

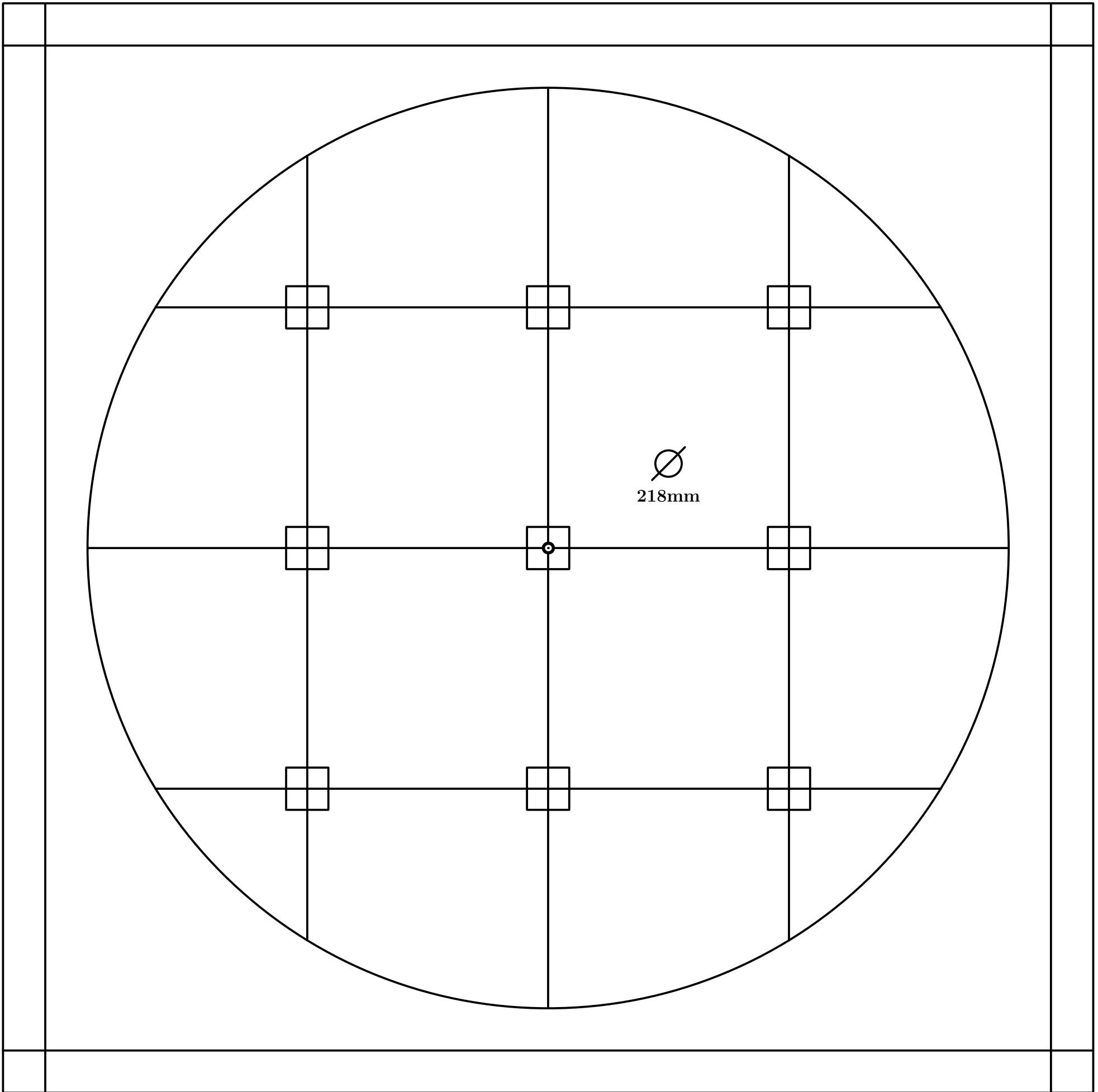

Fig. 473

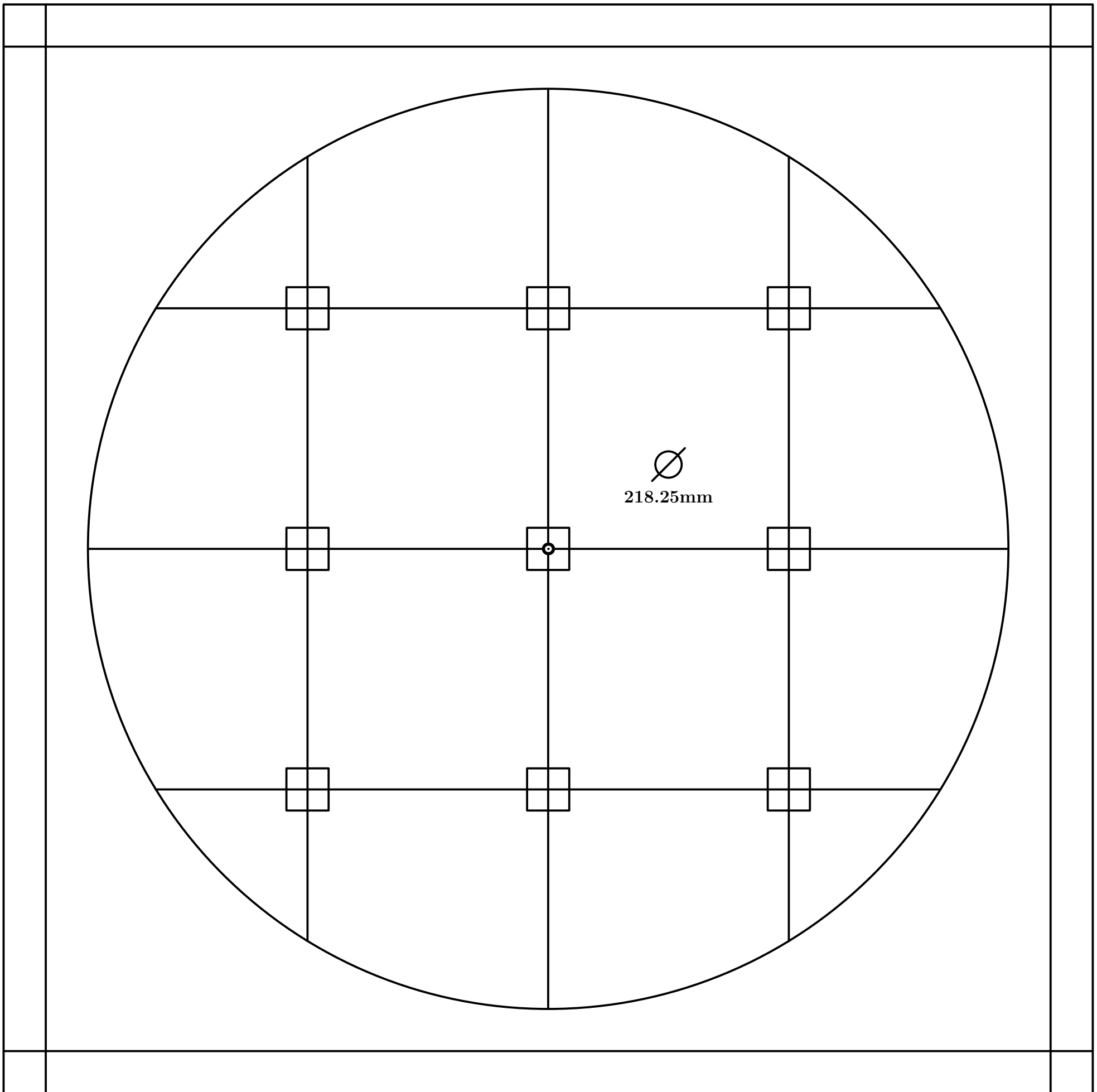

Fig. 474

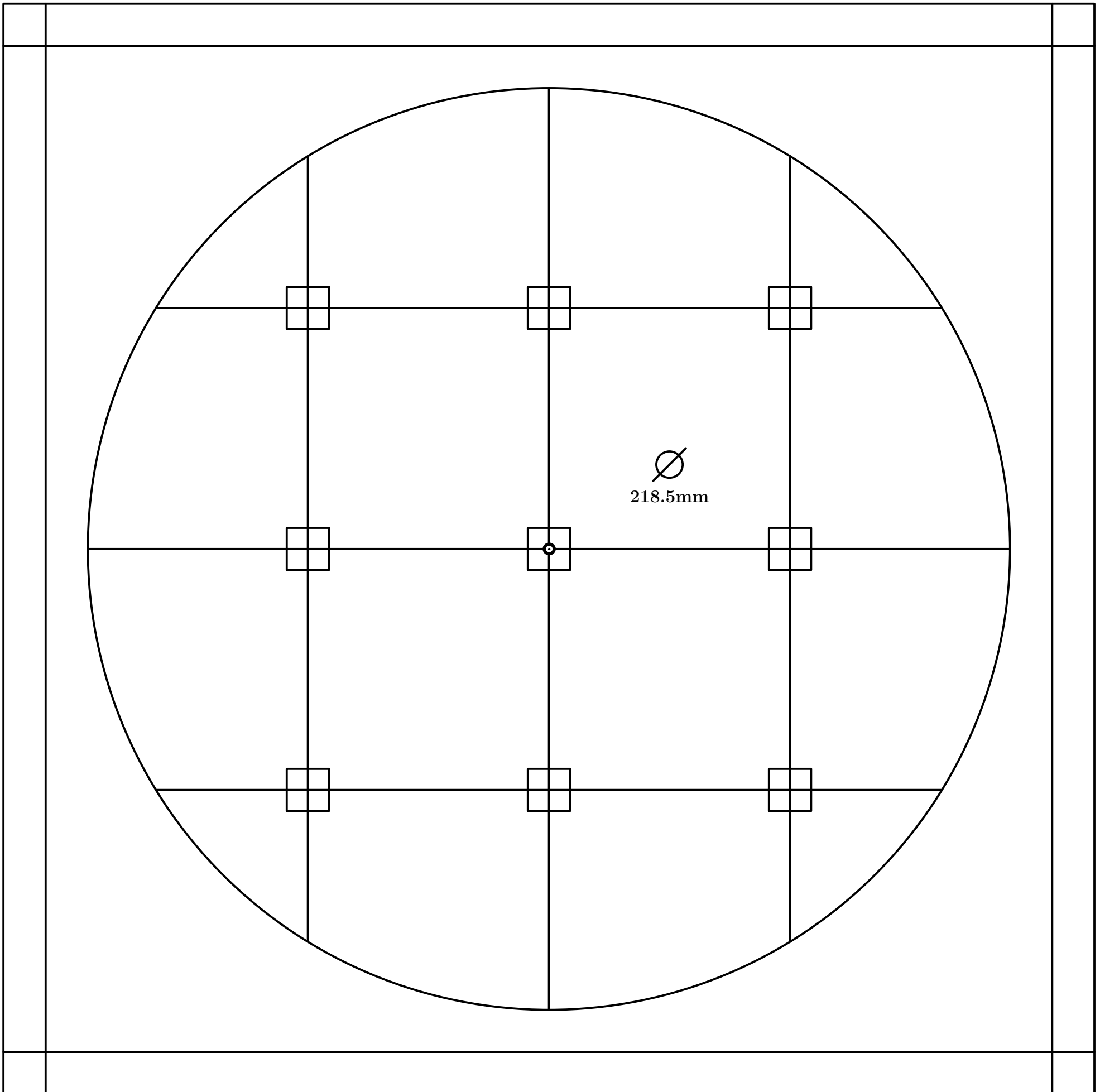

Fig. 475

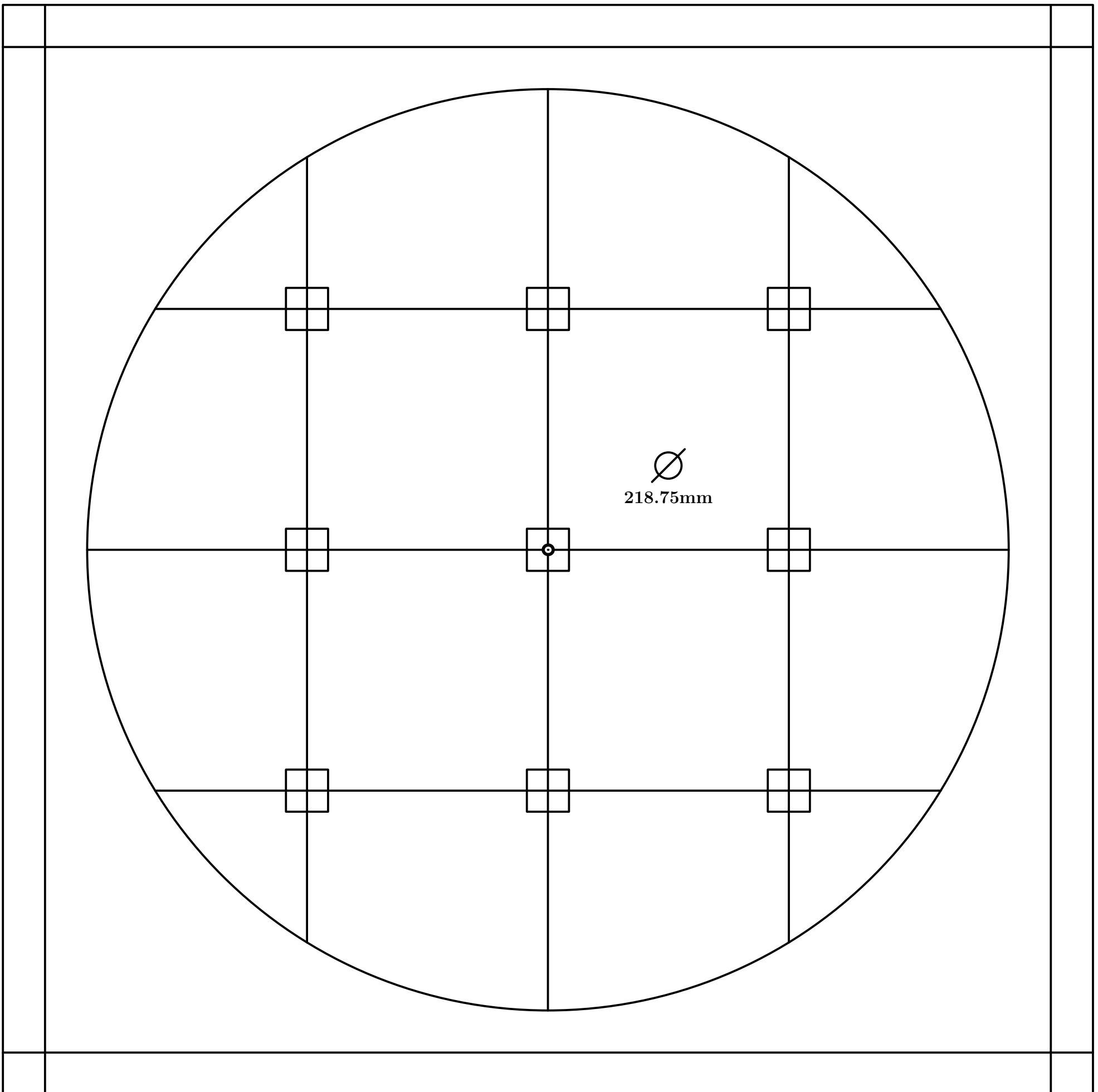

Fig. 476

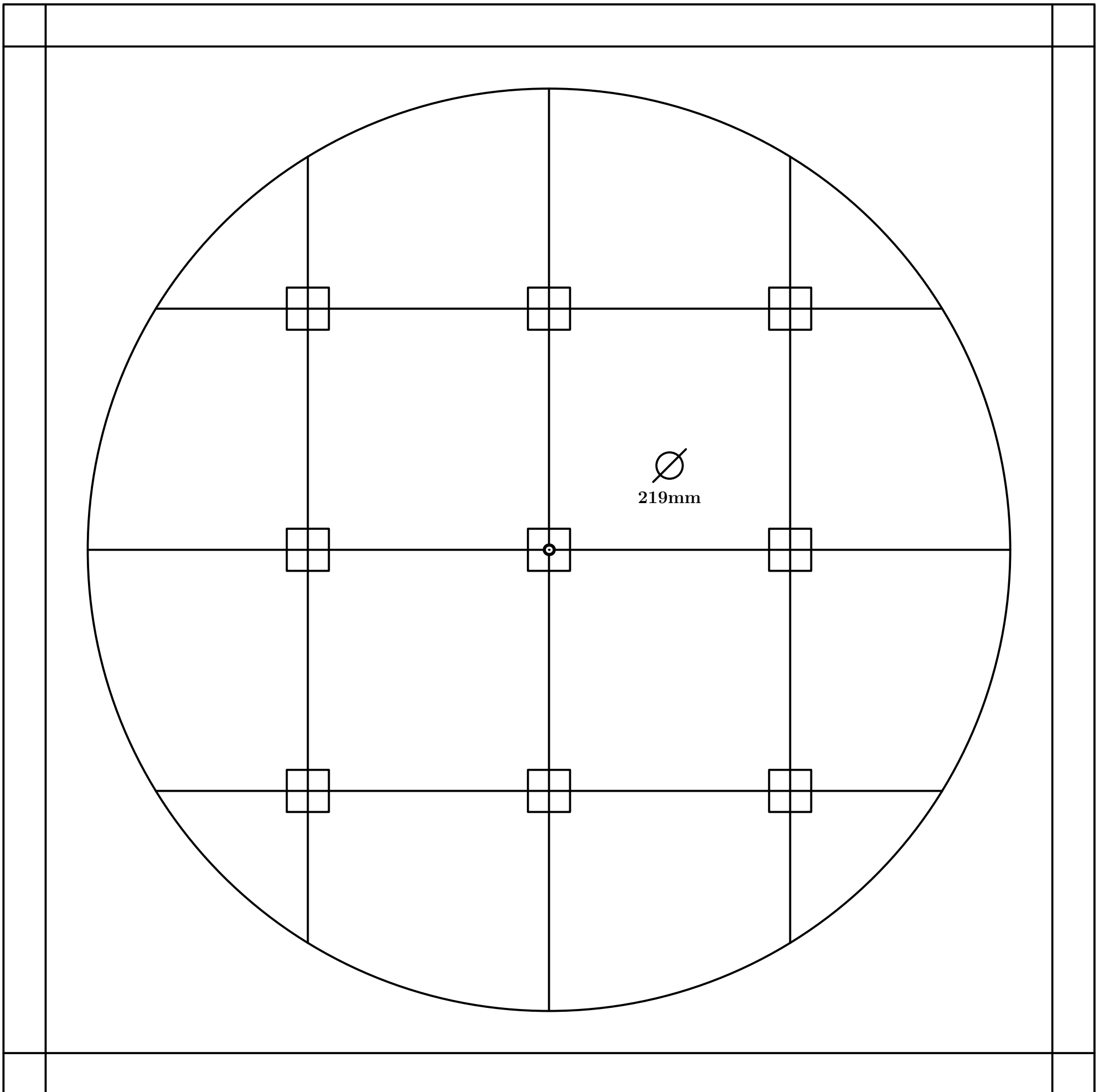

Fig. 477

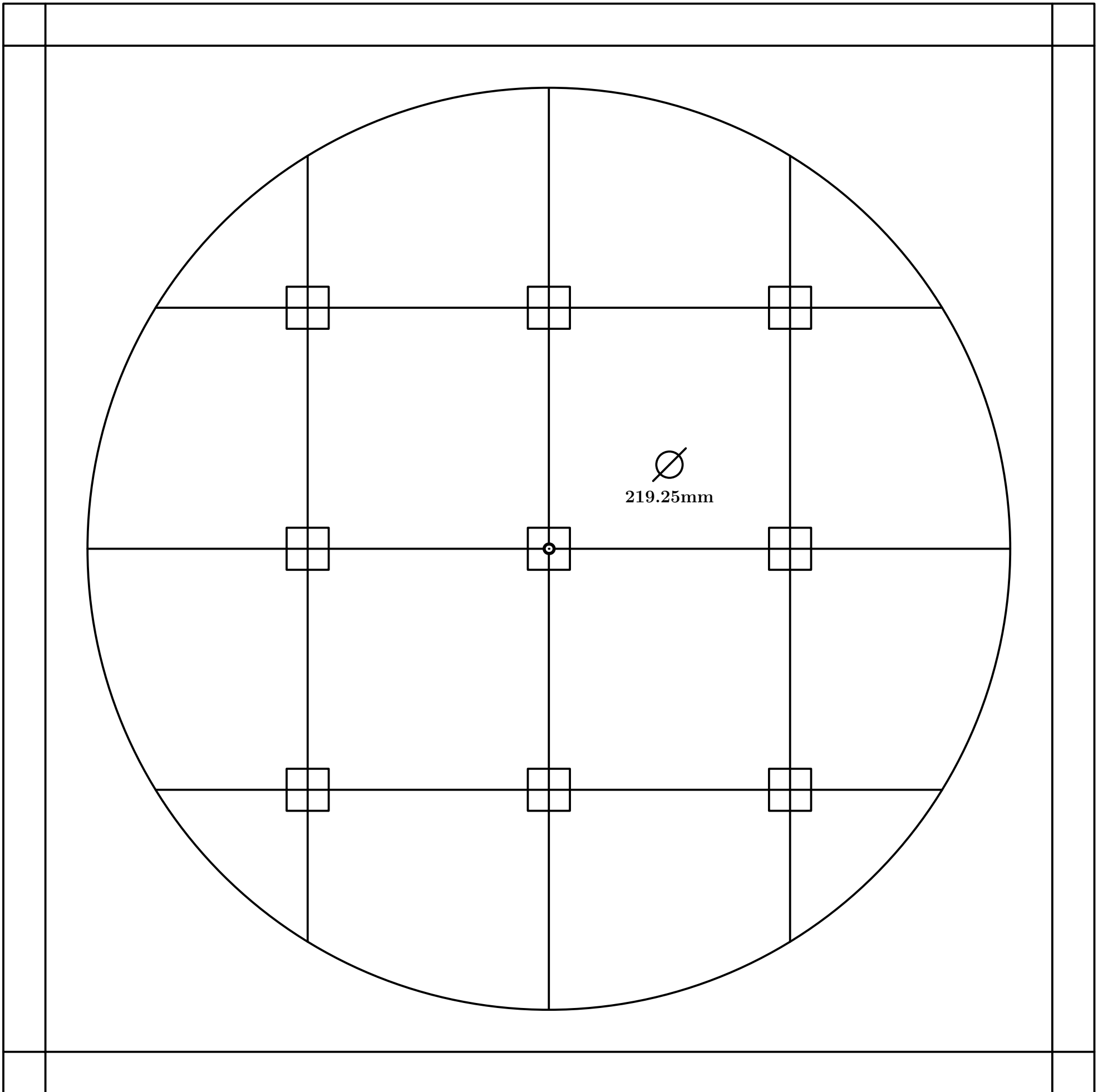

Fig. 478

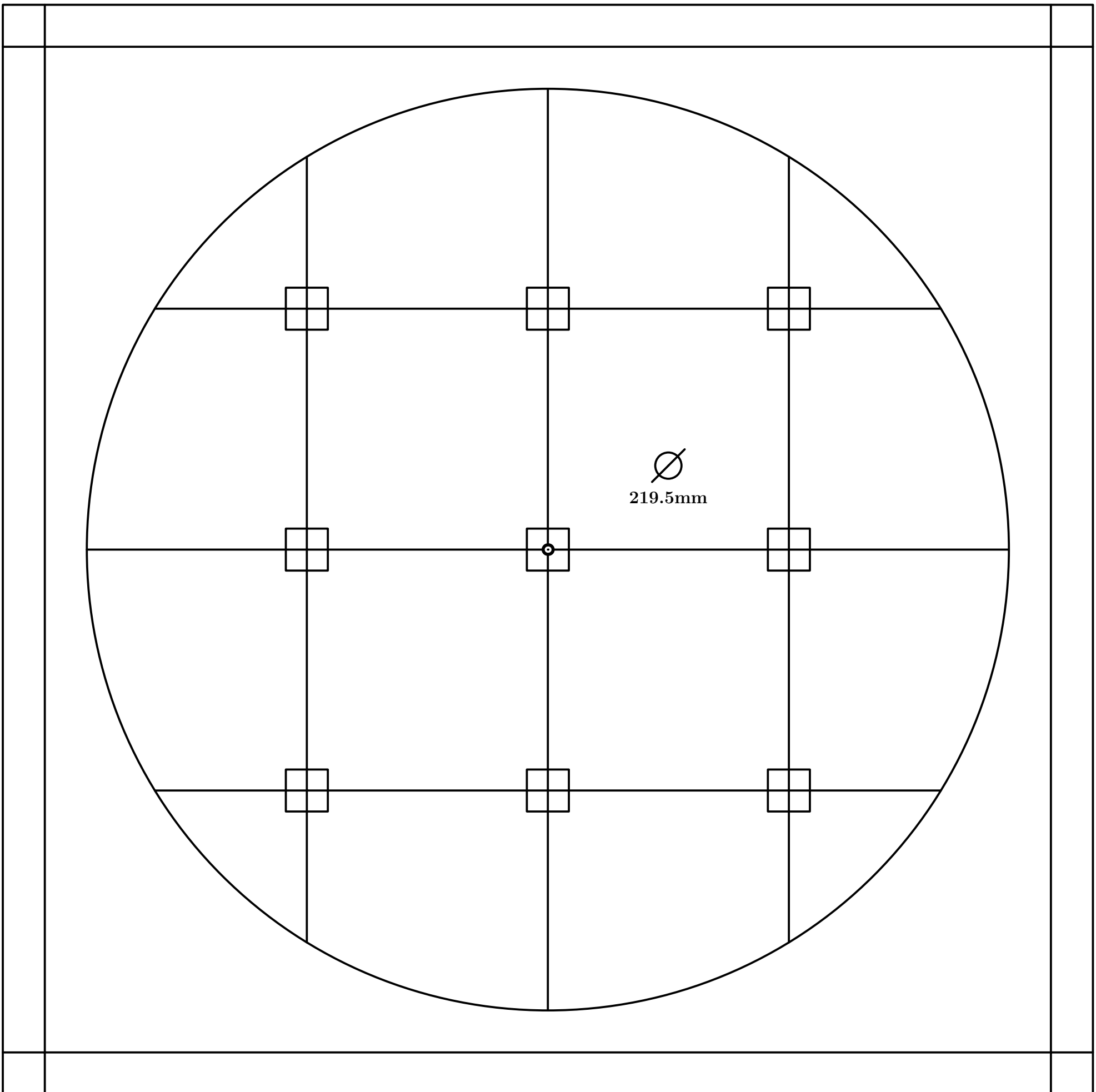

Fig. 479

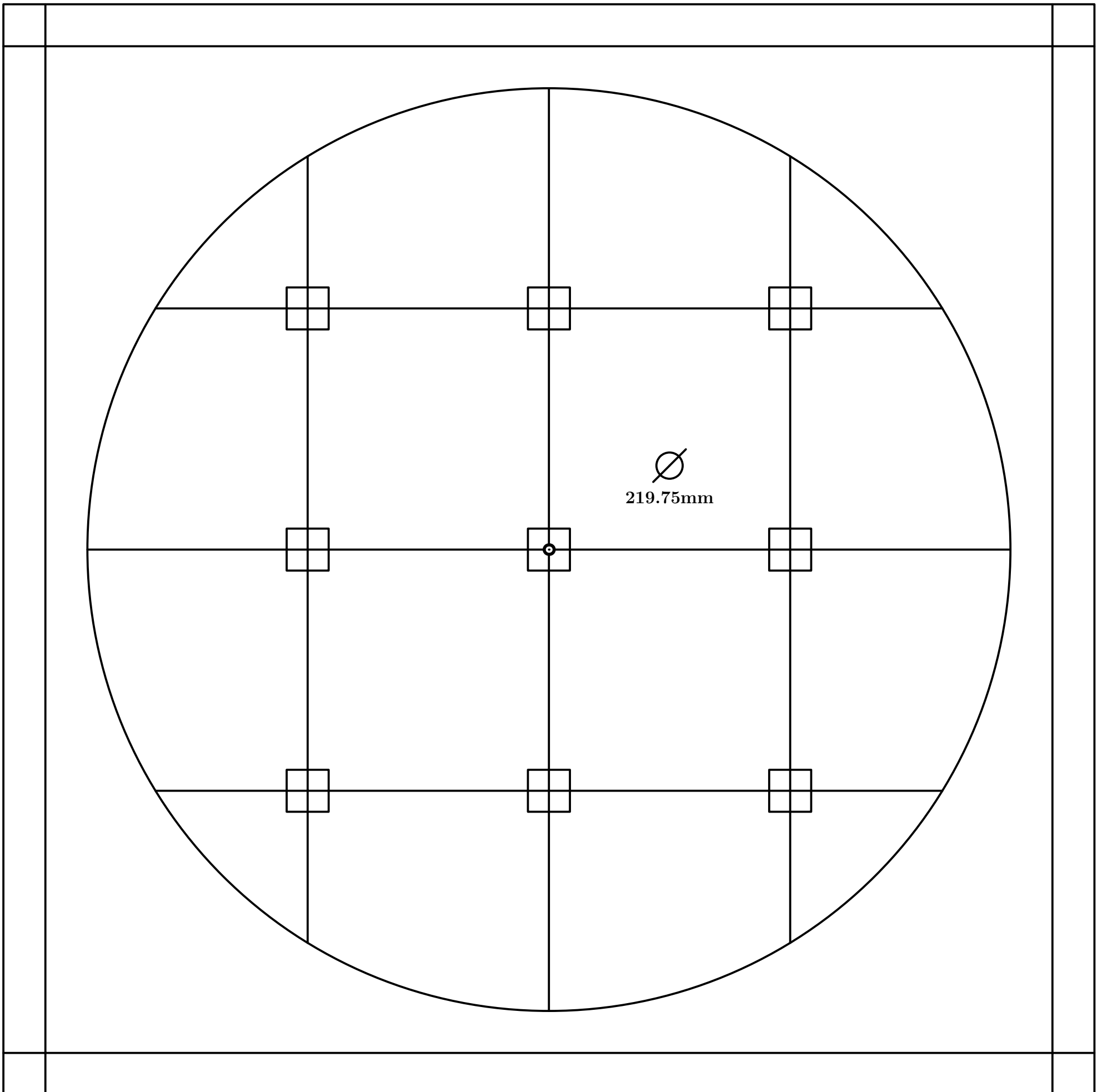

Fig. 480

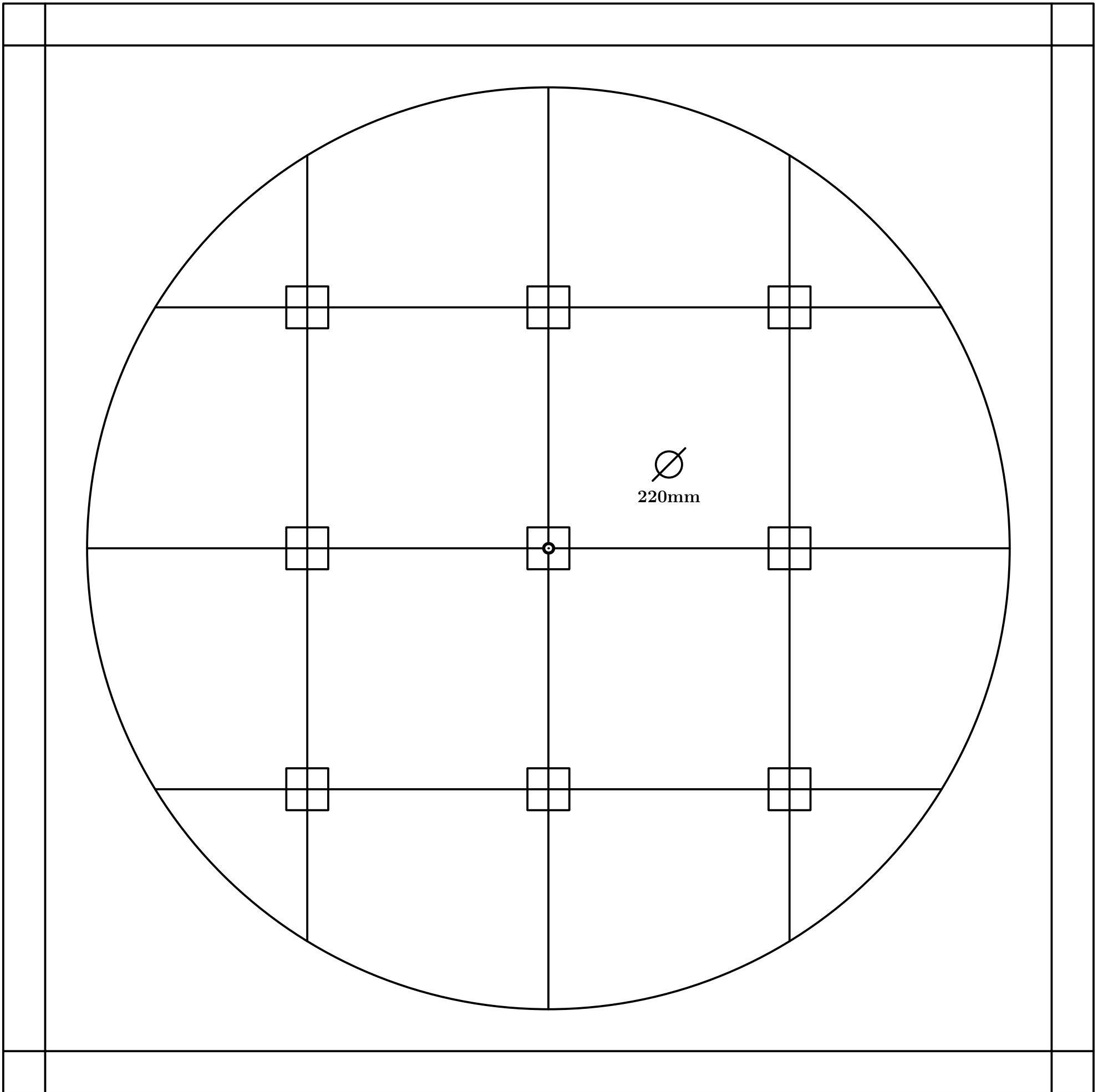

Fig. 481

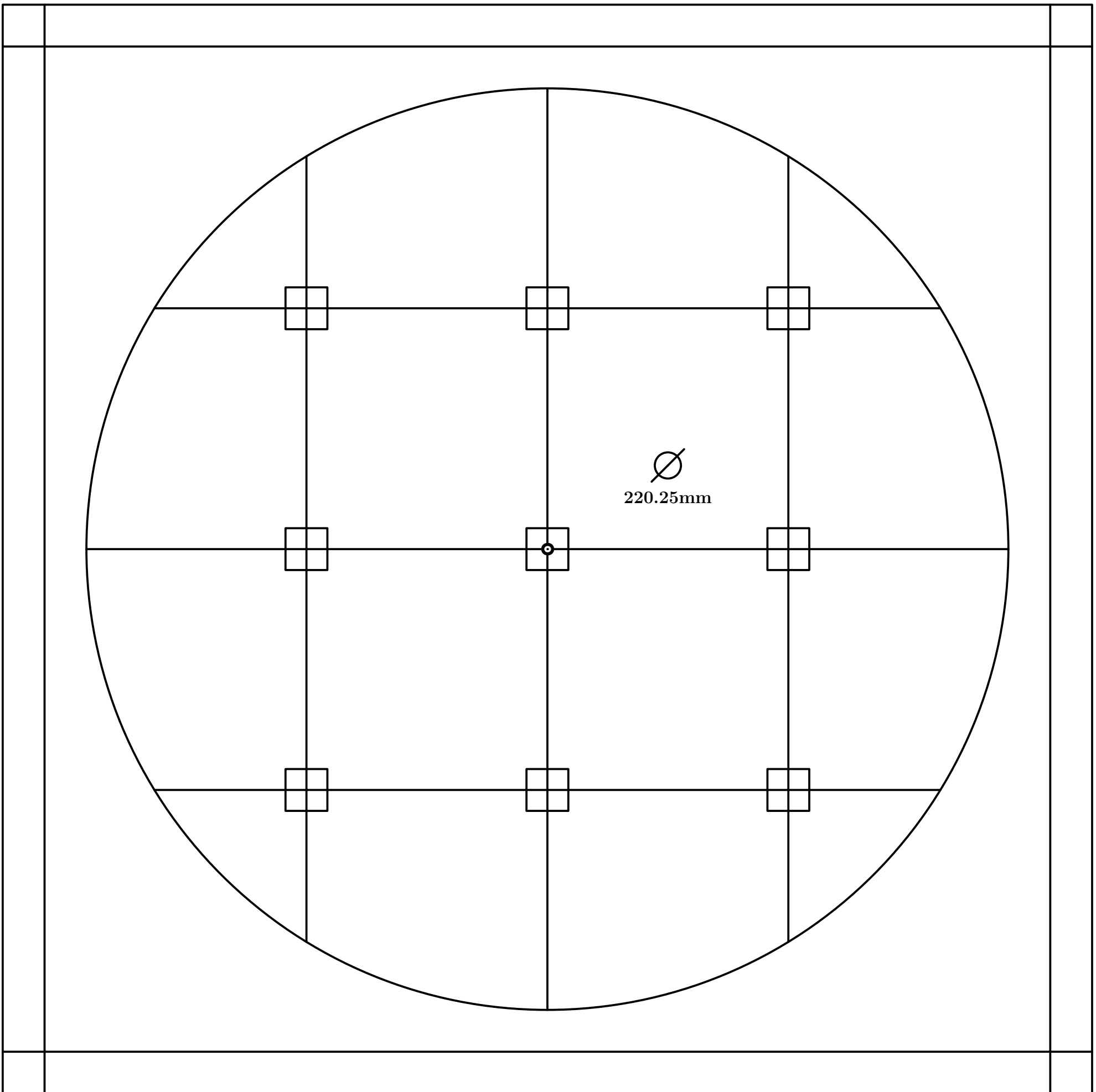

Fig. 482

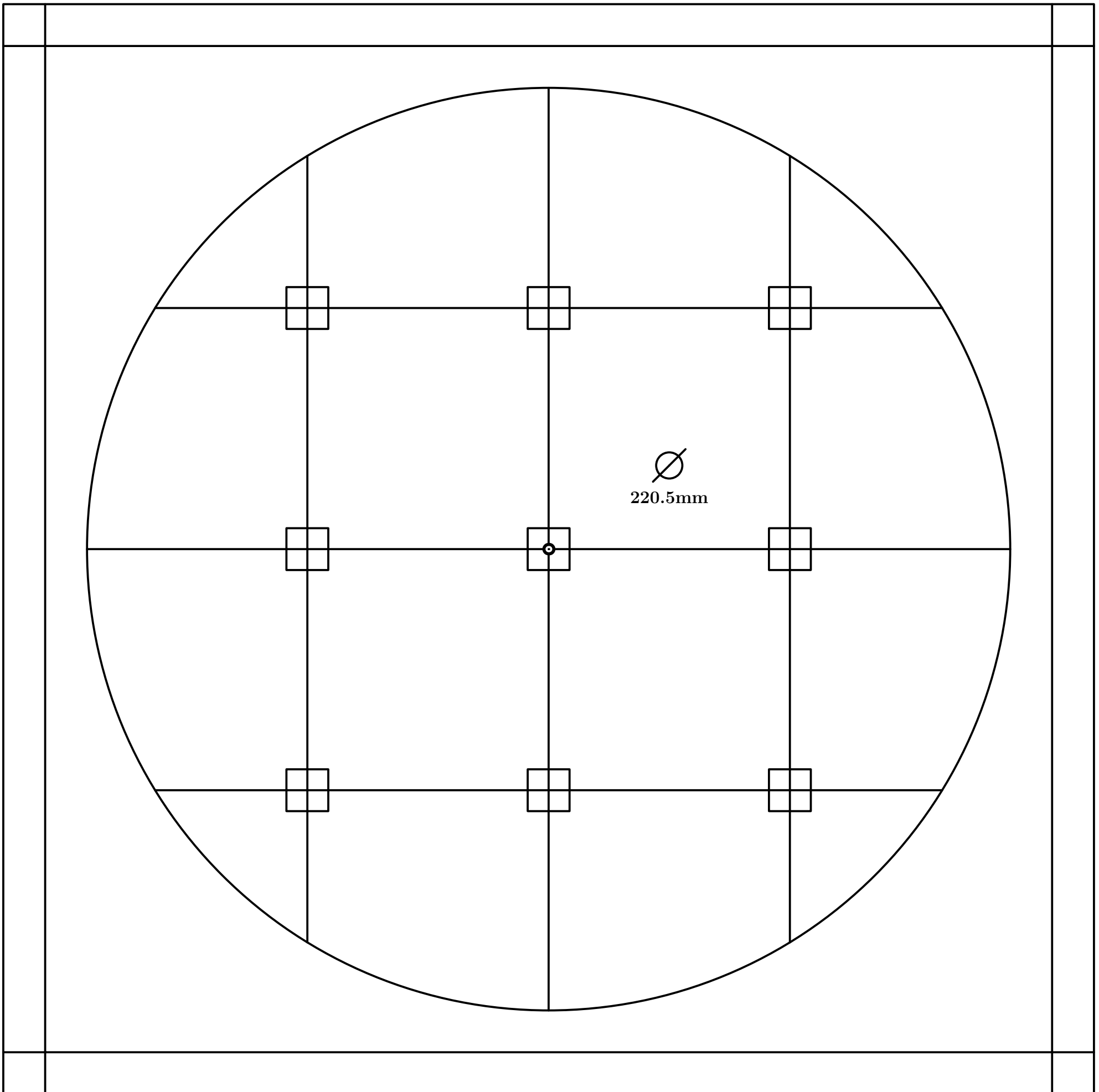

Fig. 483

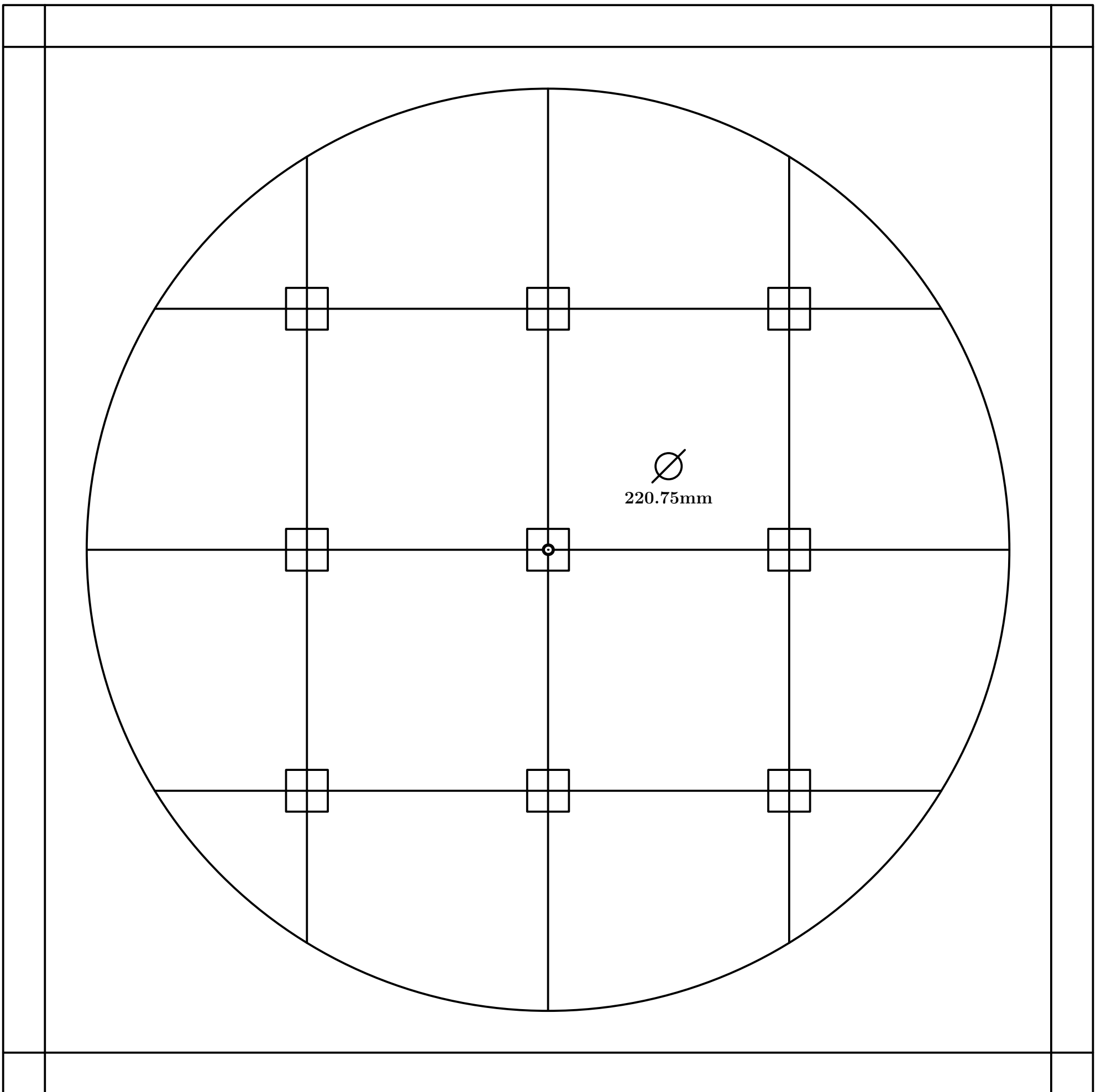

Fig. 484

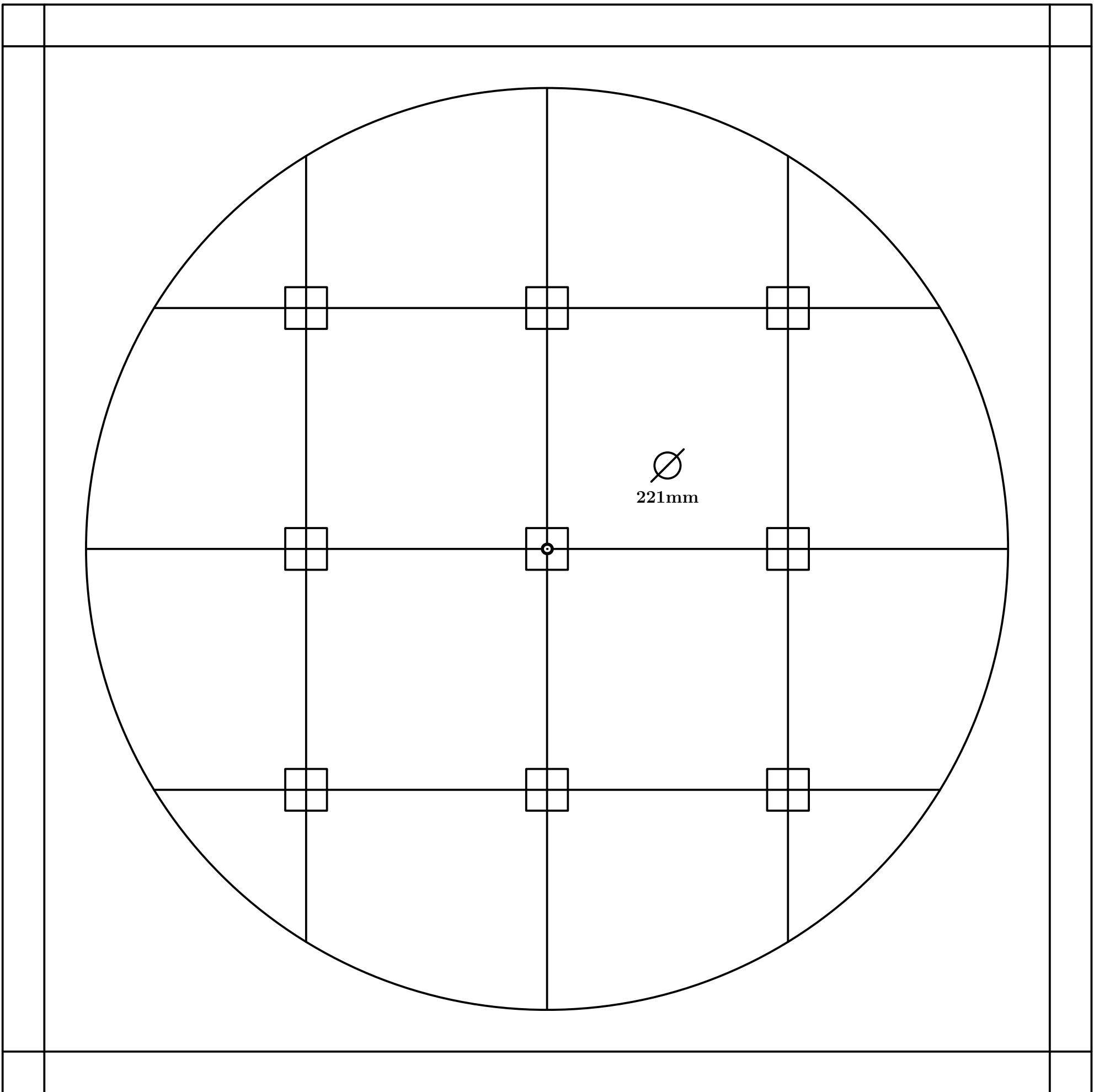

Fig. 485

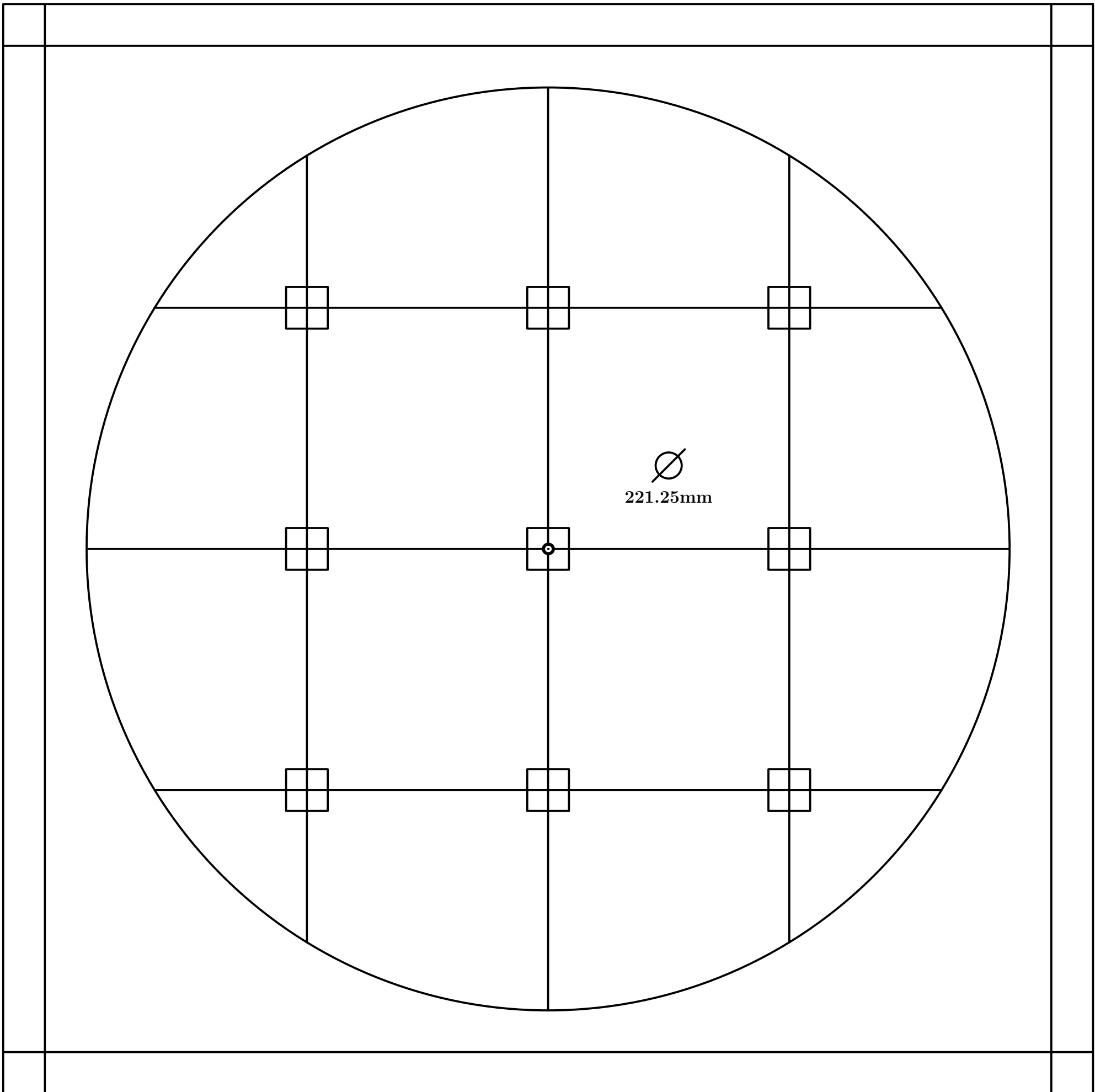

Fig. 486

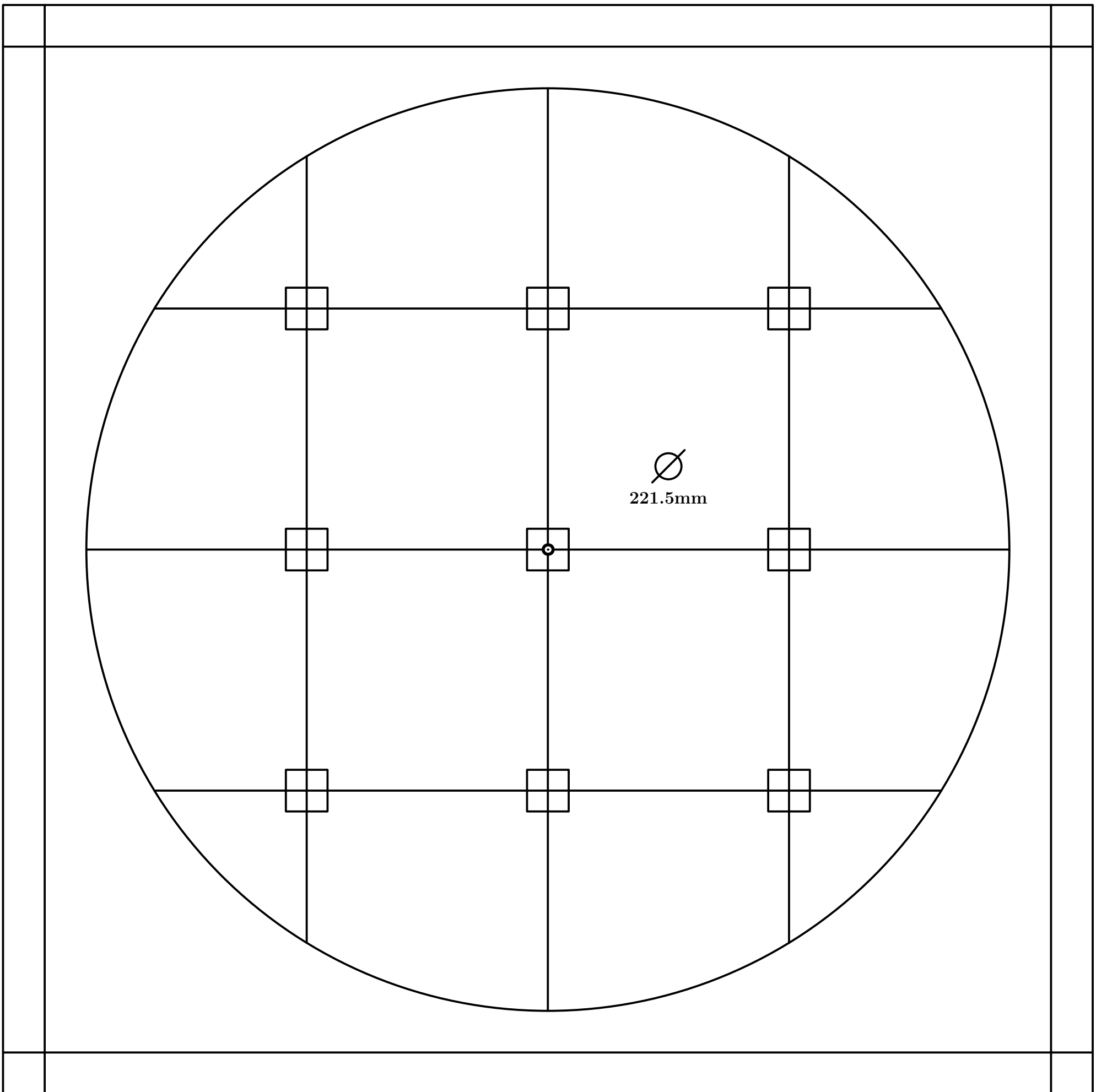

Fig. 487

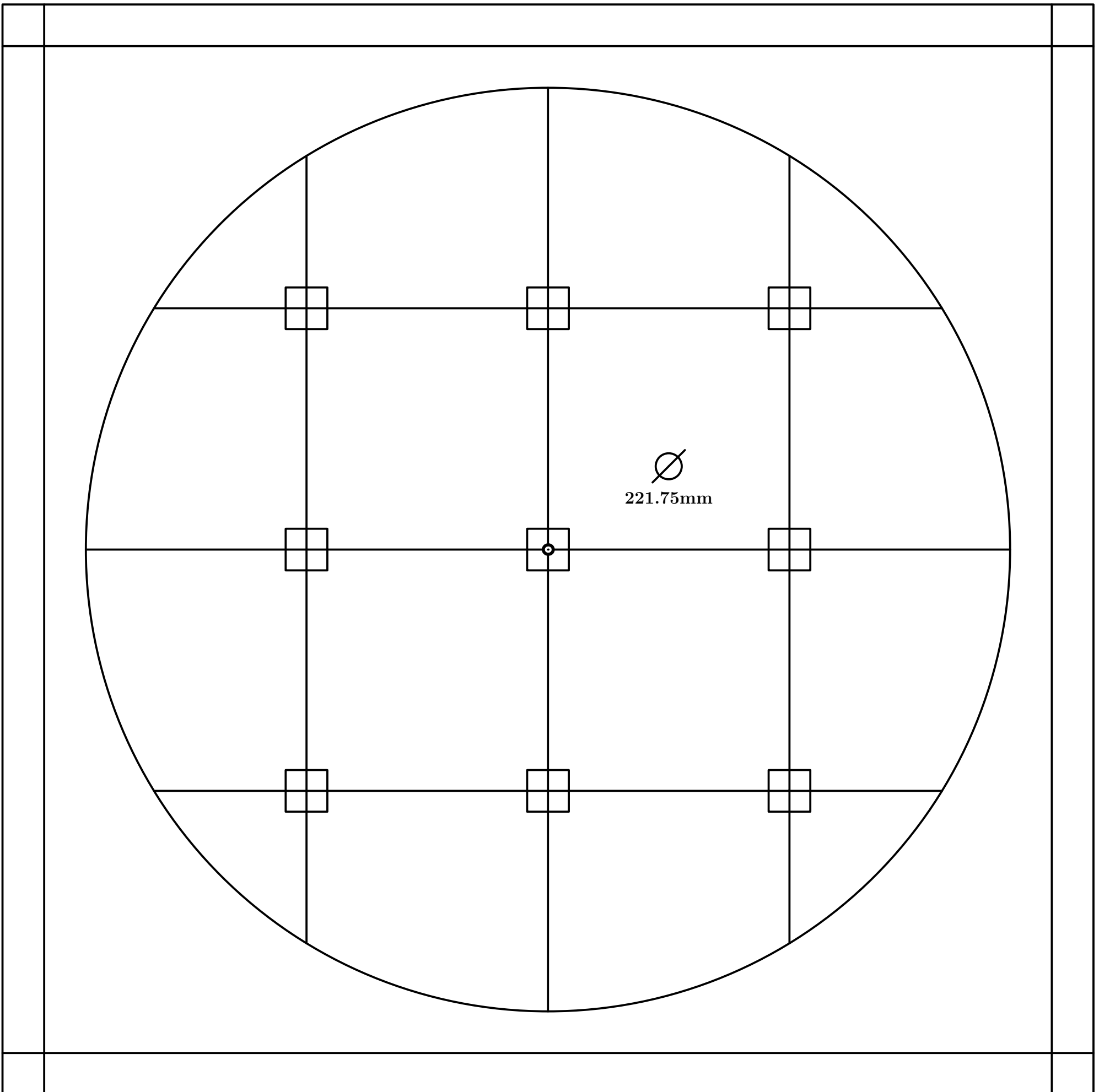

Fig. 488

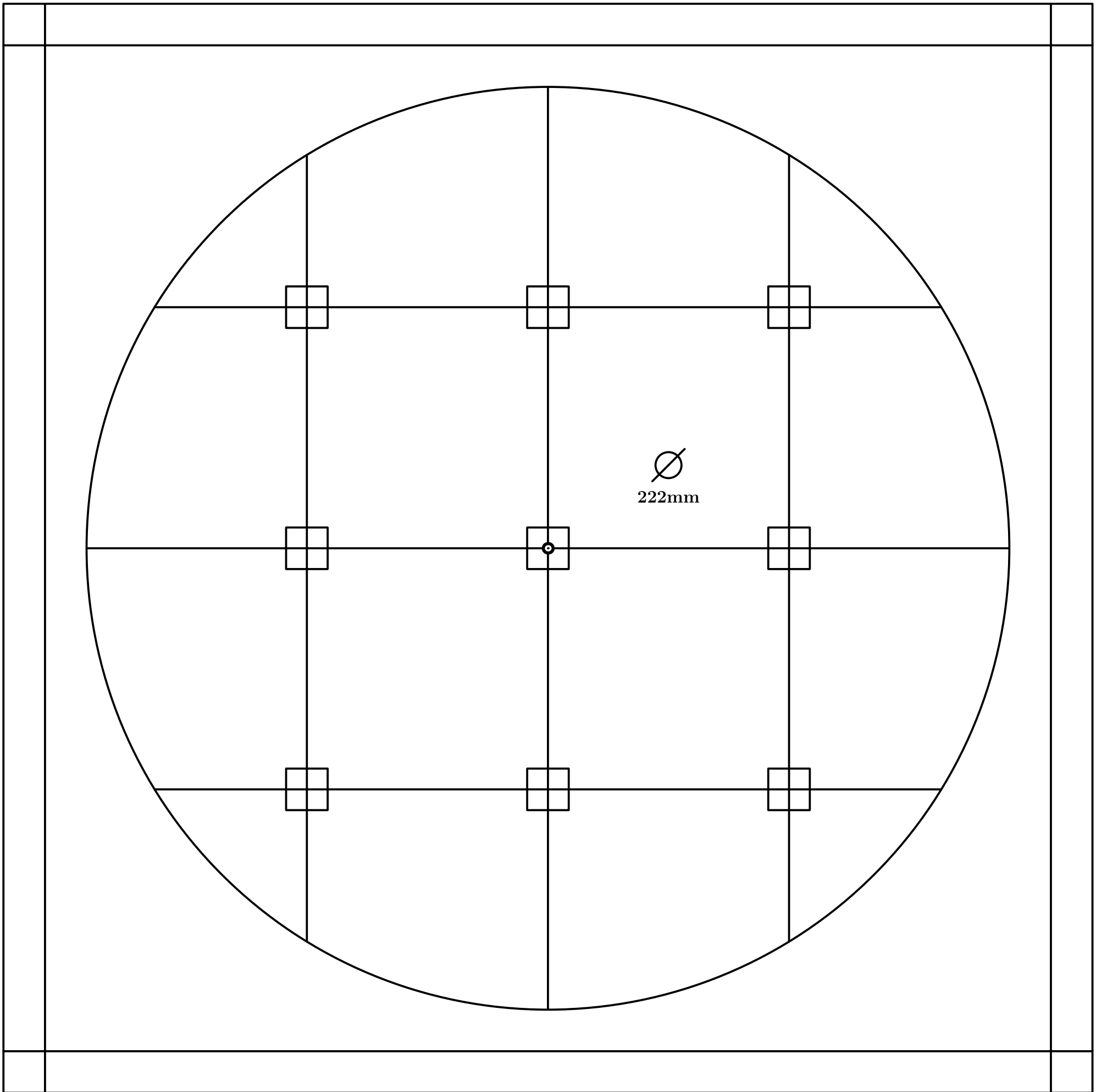

Fig. 489

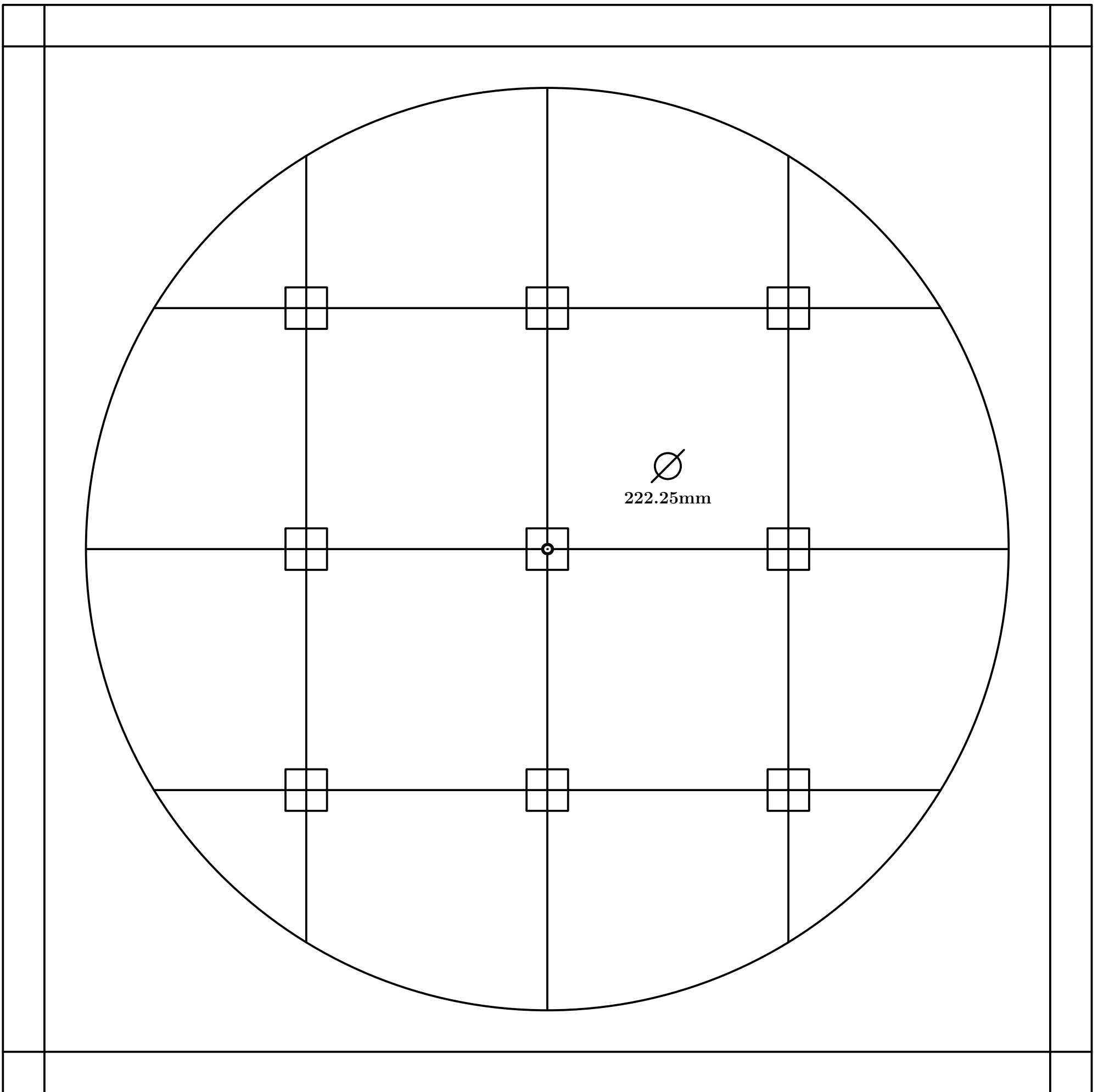

Fig. 490

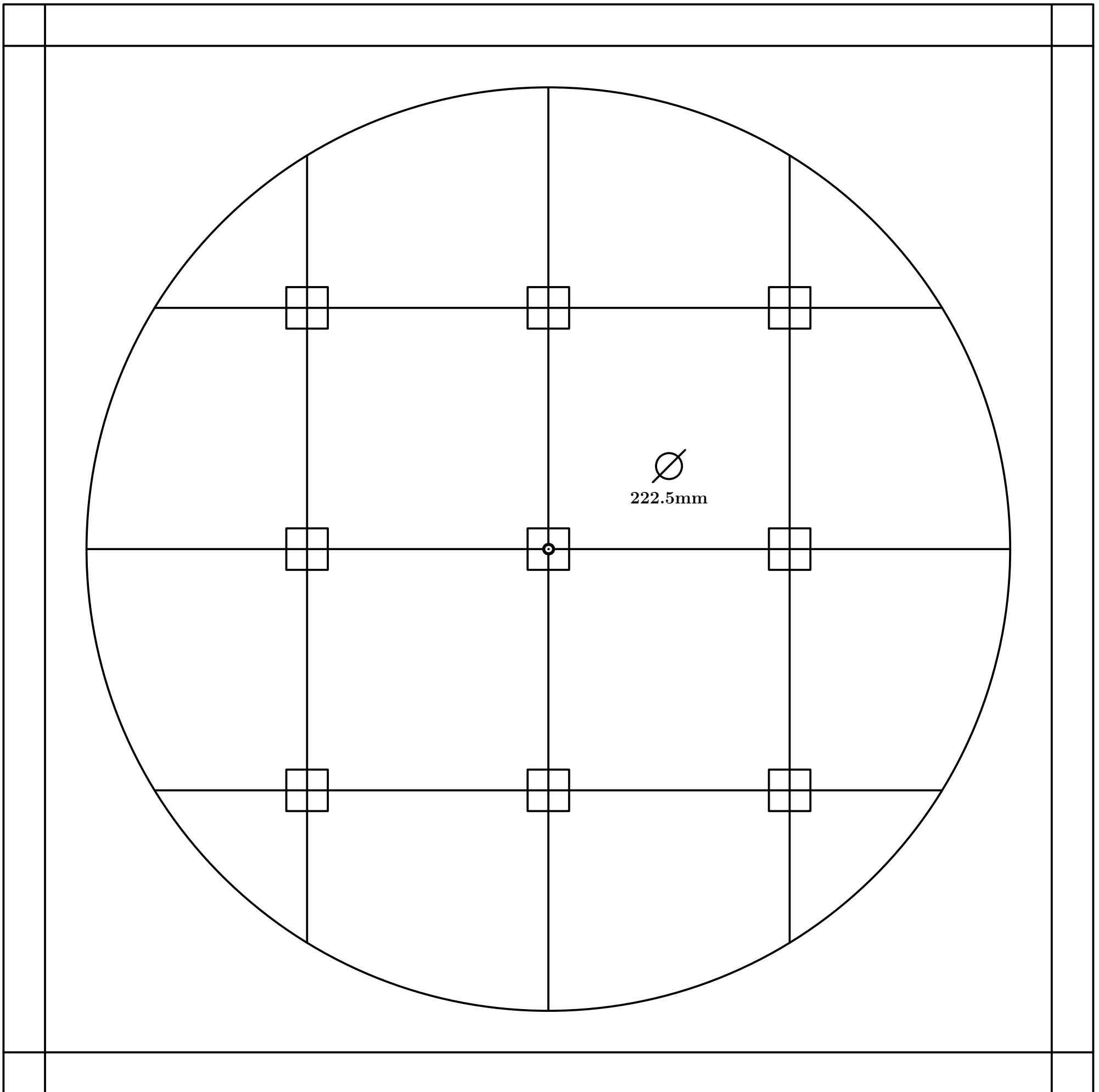

Fig. 491

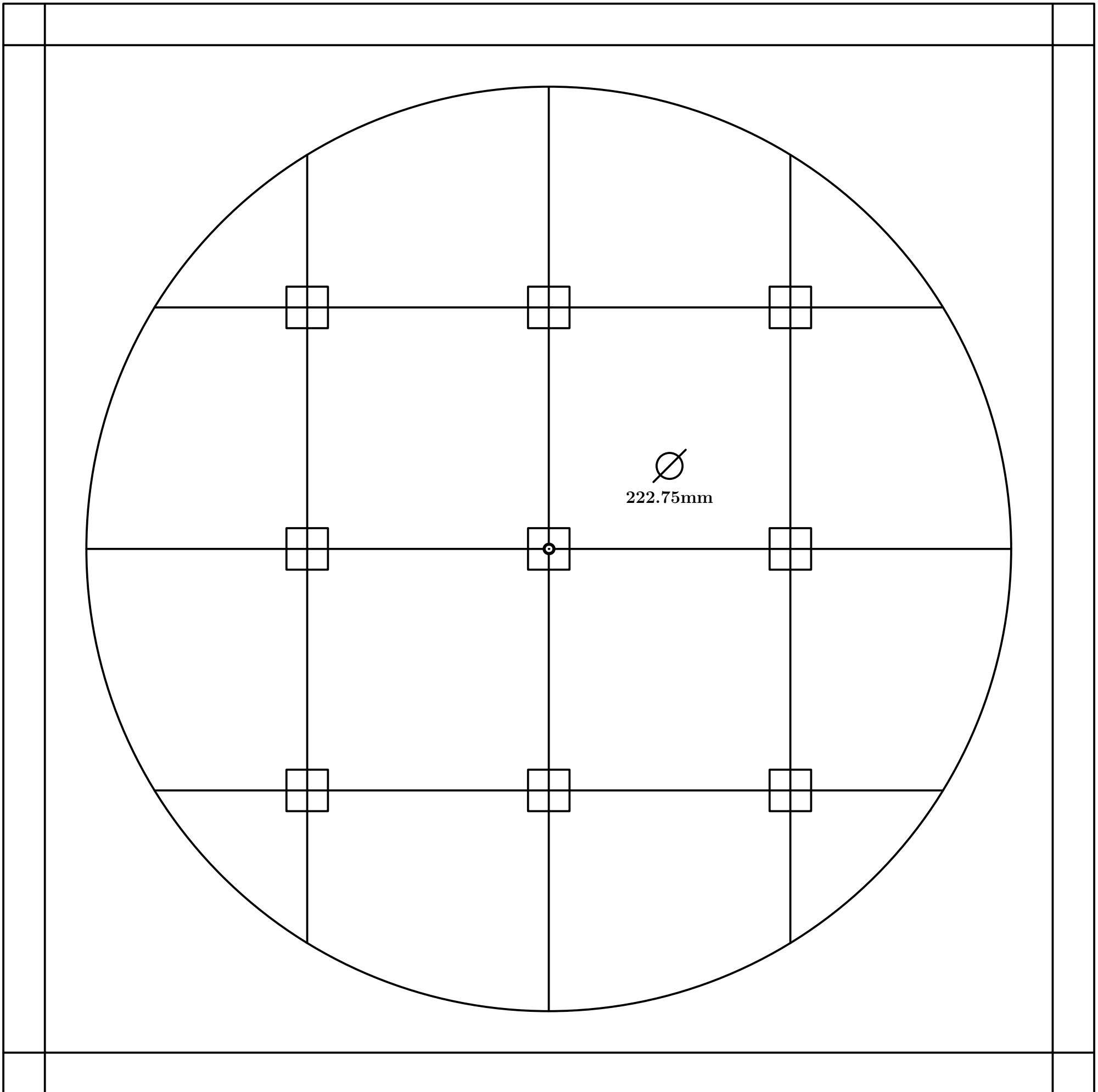

Fig. 492

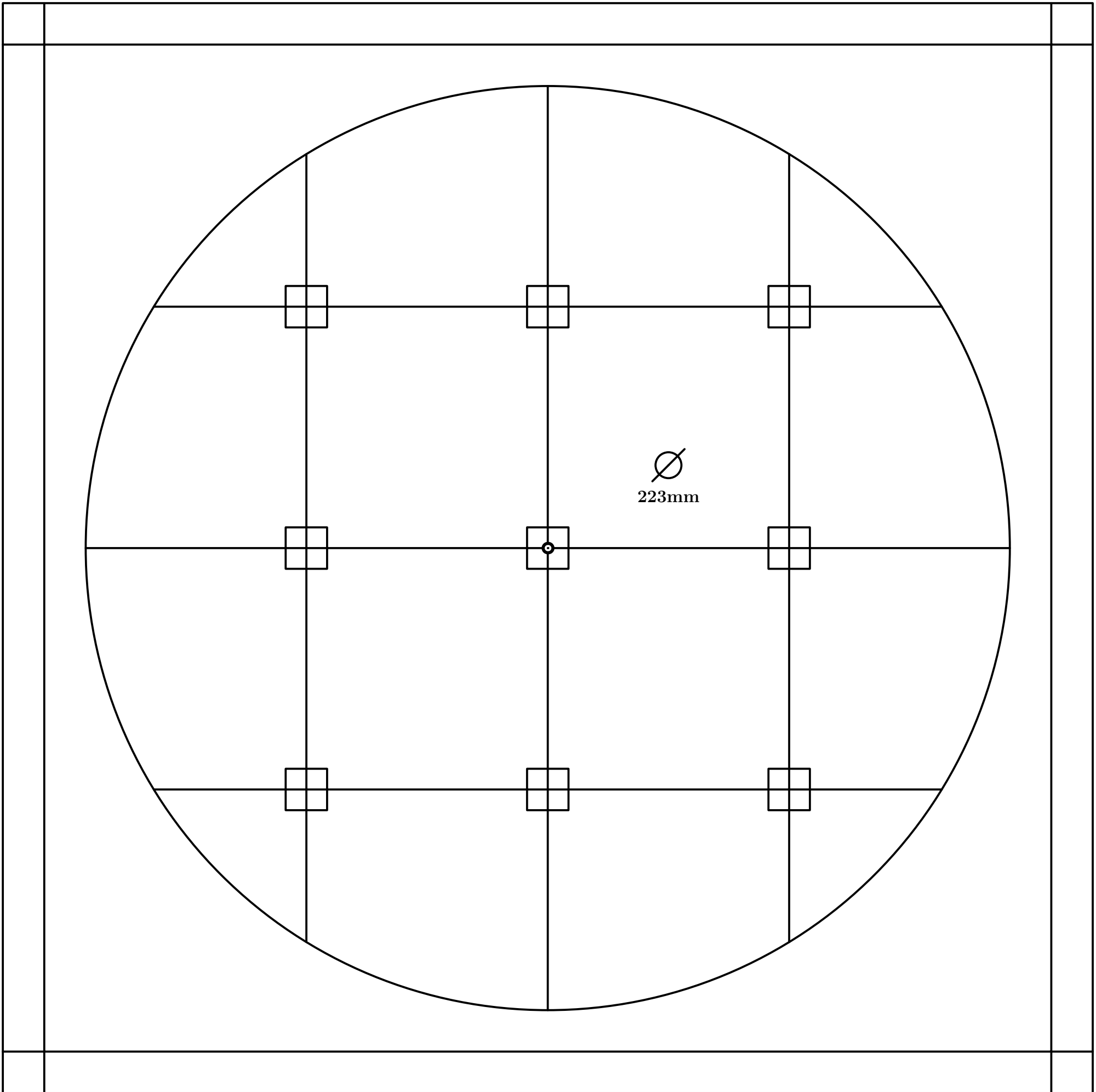

Fig. 493

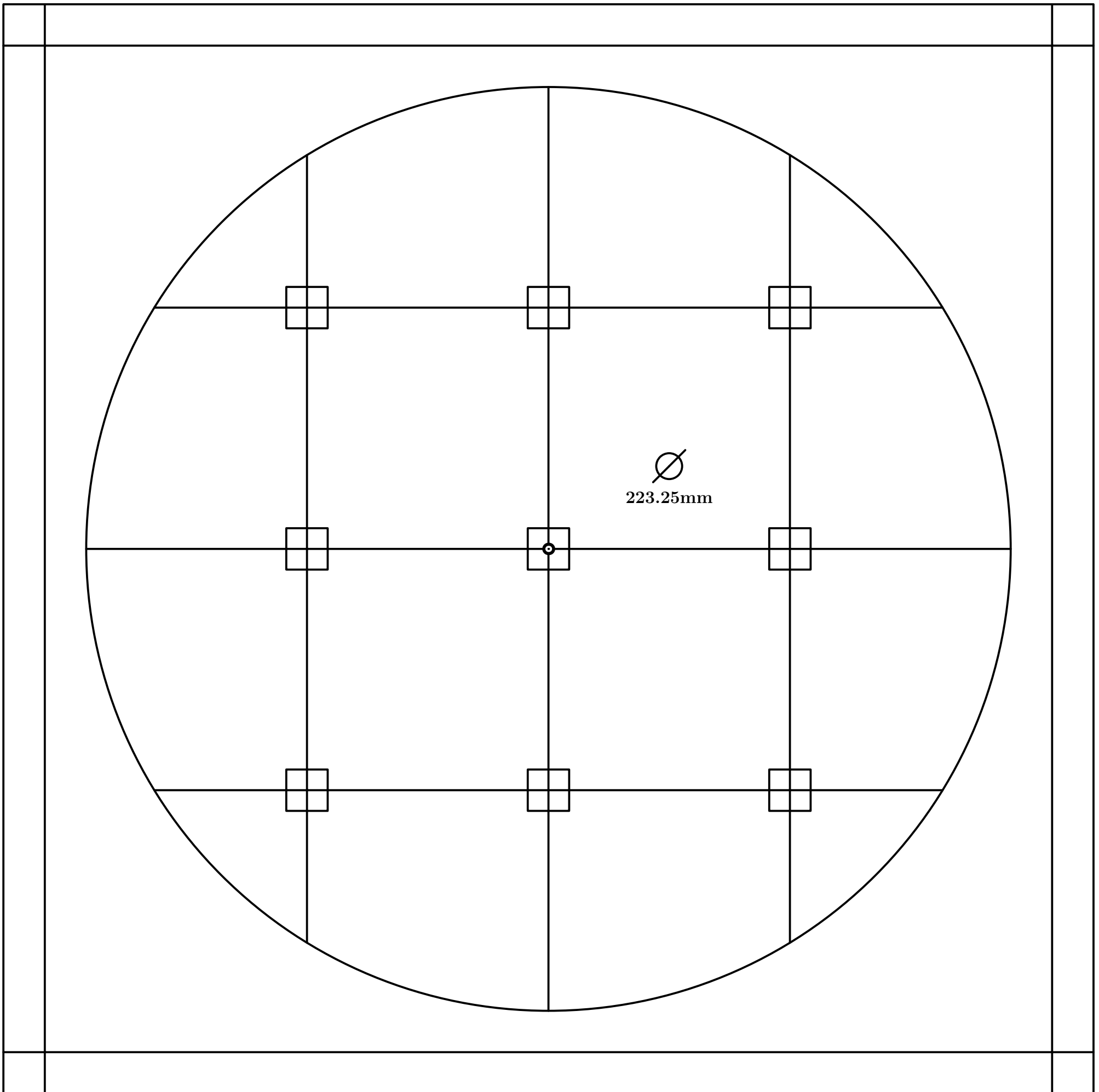

Fig. 494

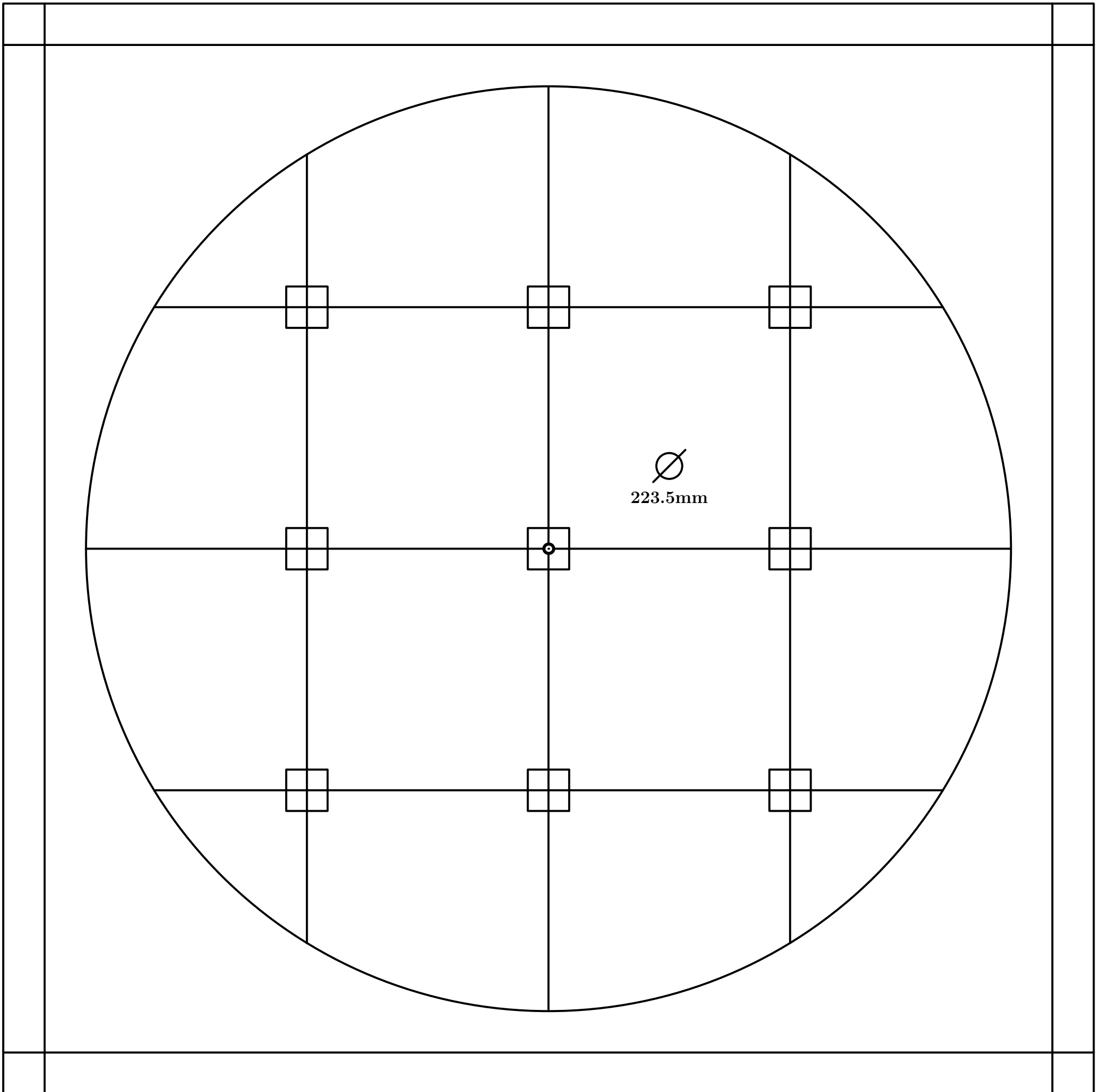

Fig. 495

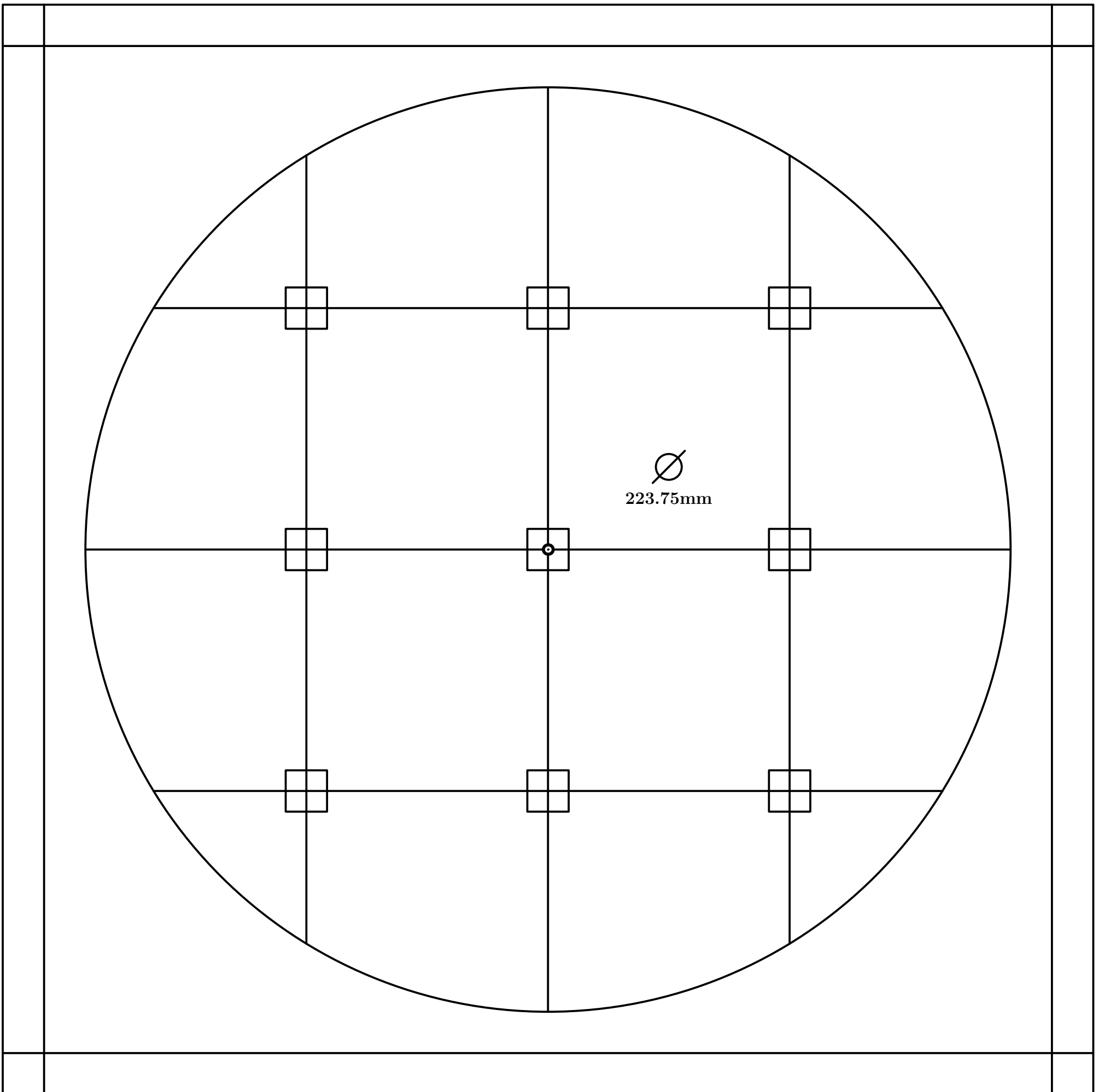

Fig. 496

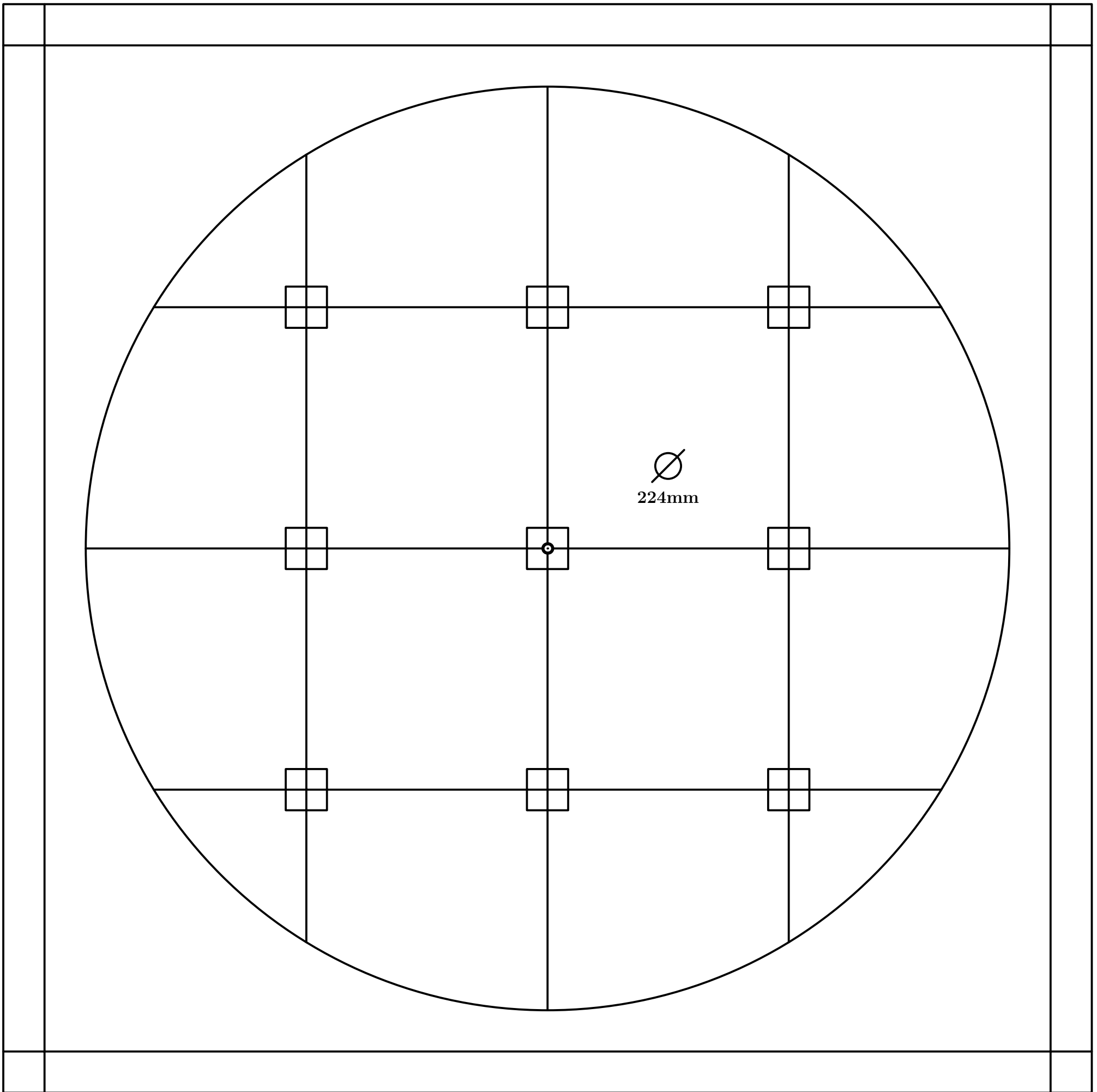

Fig. 497

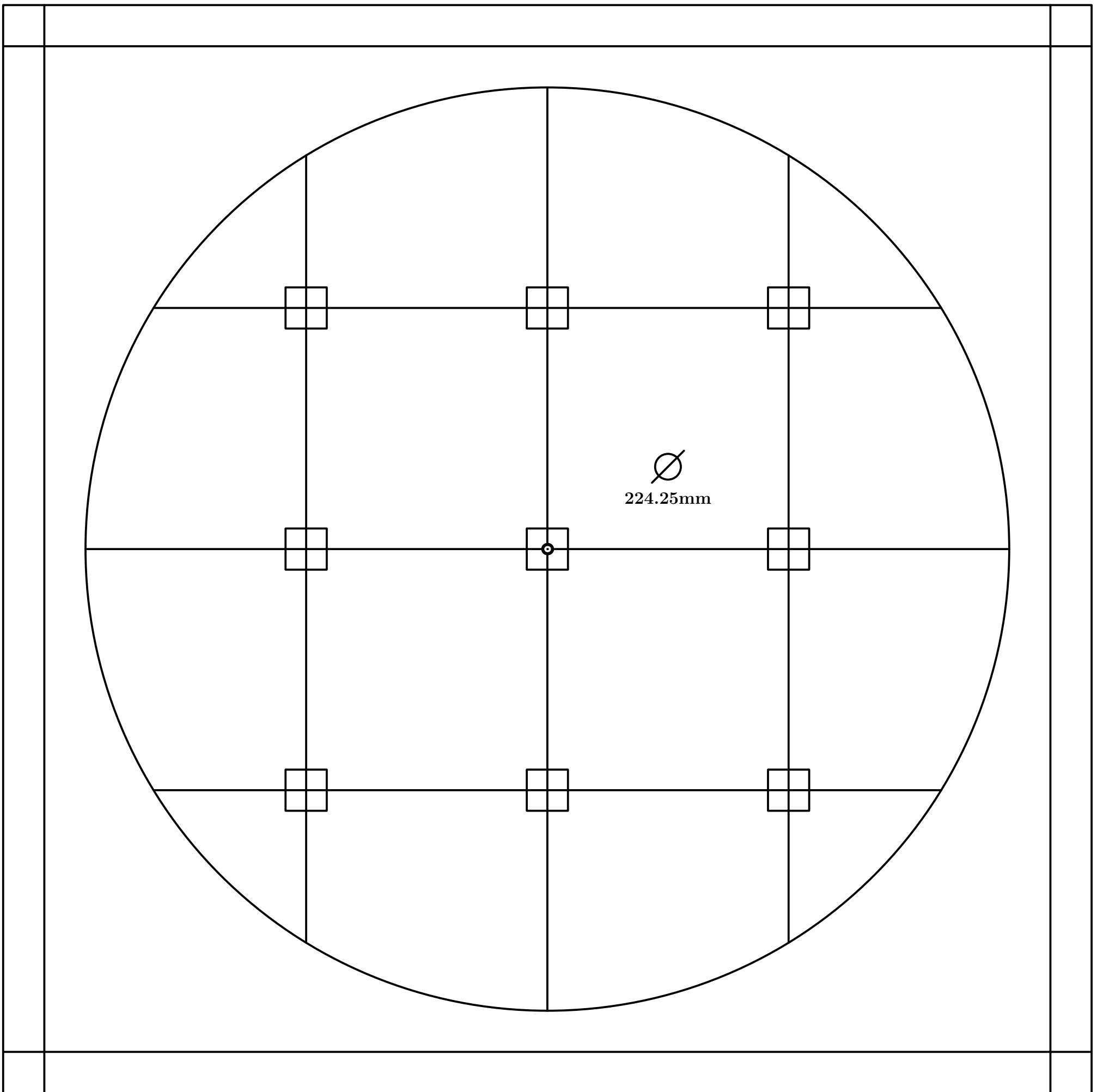

Fig. 498

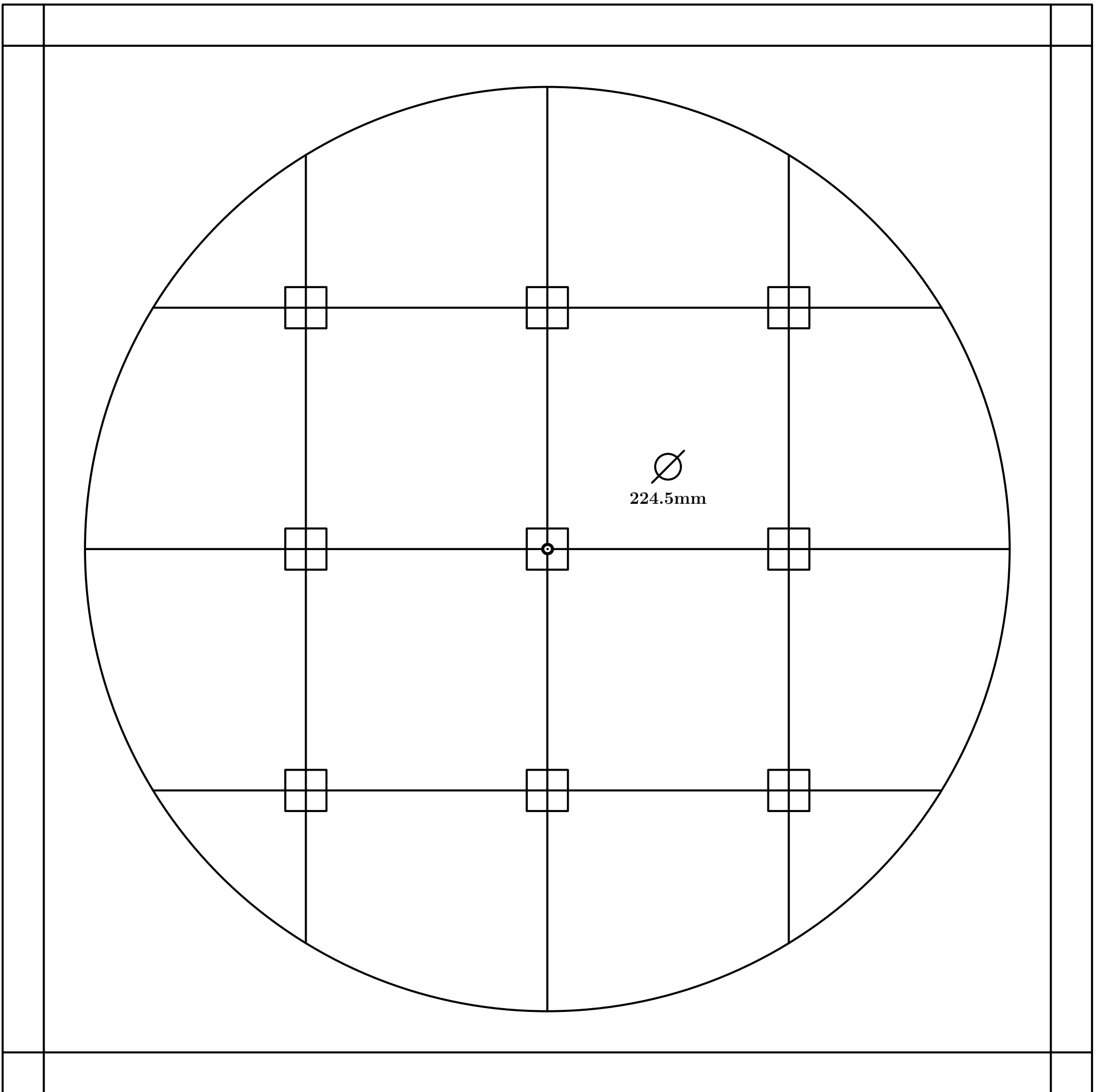

Fig. 499

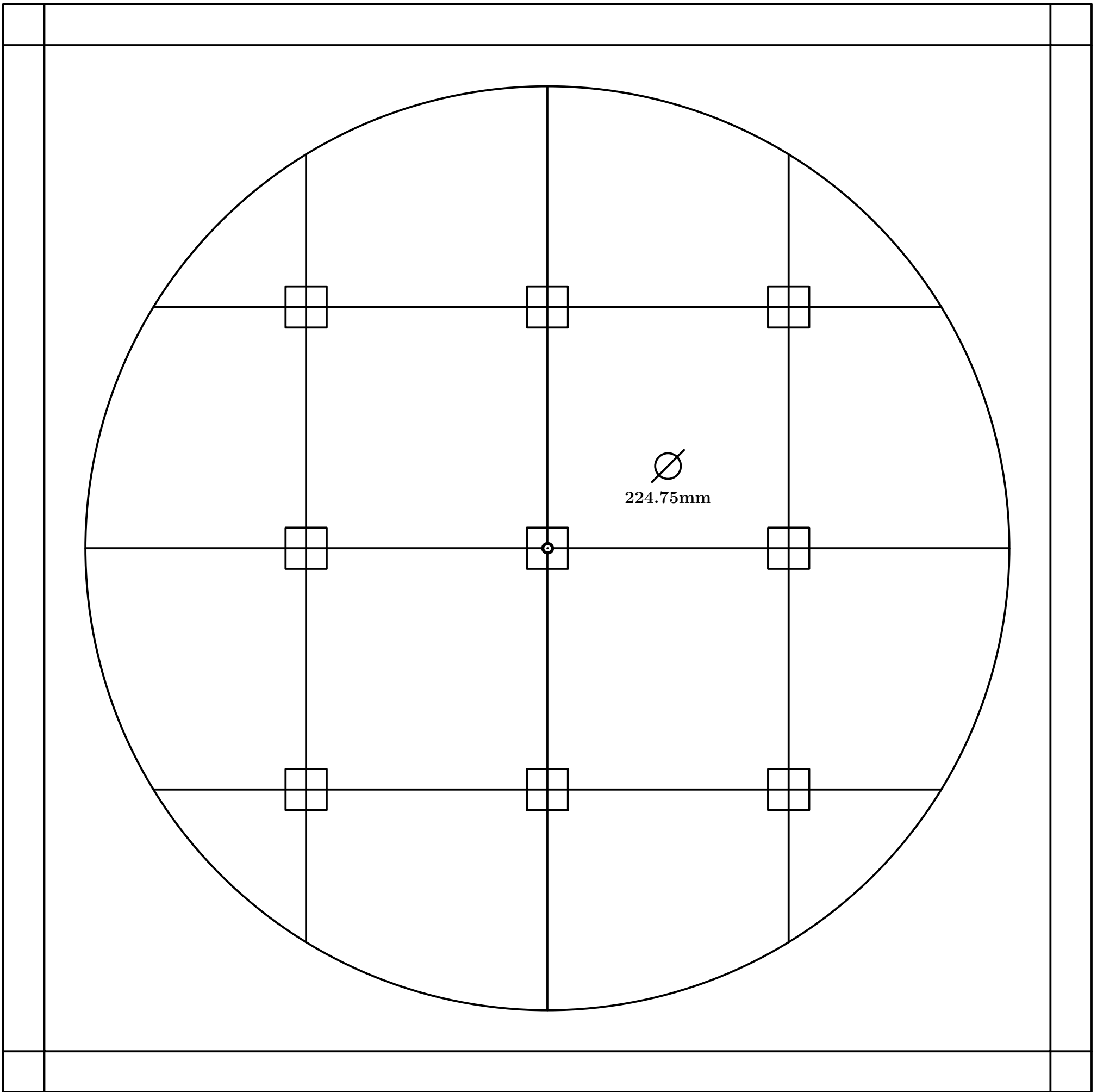

Fig. 500

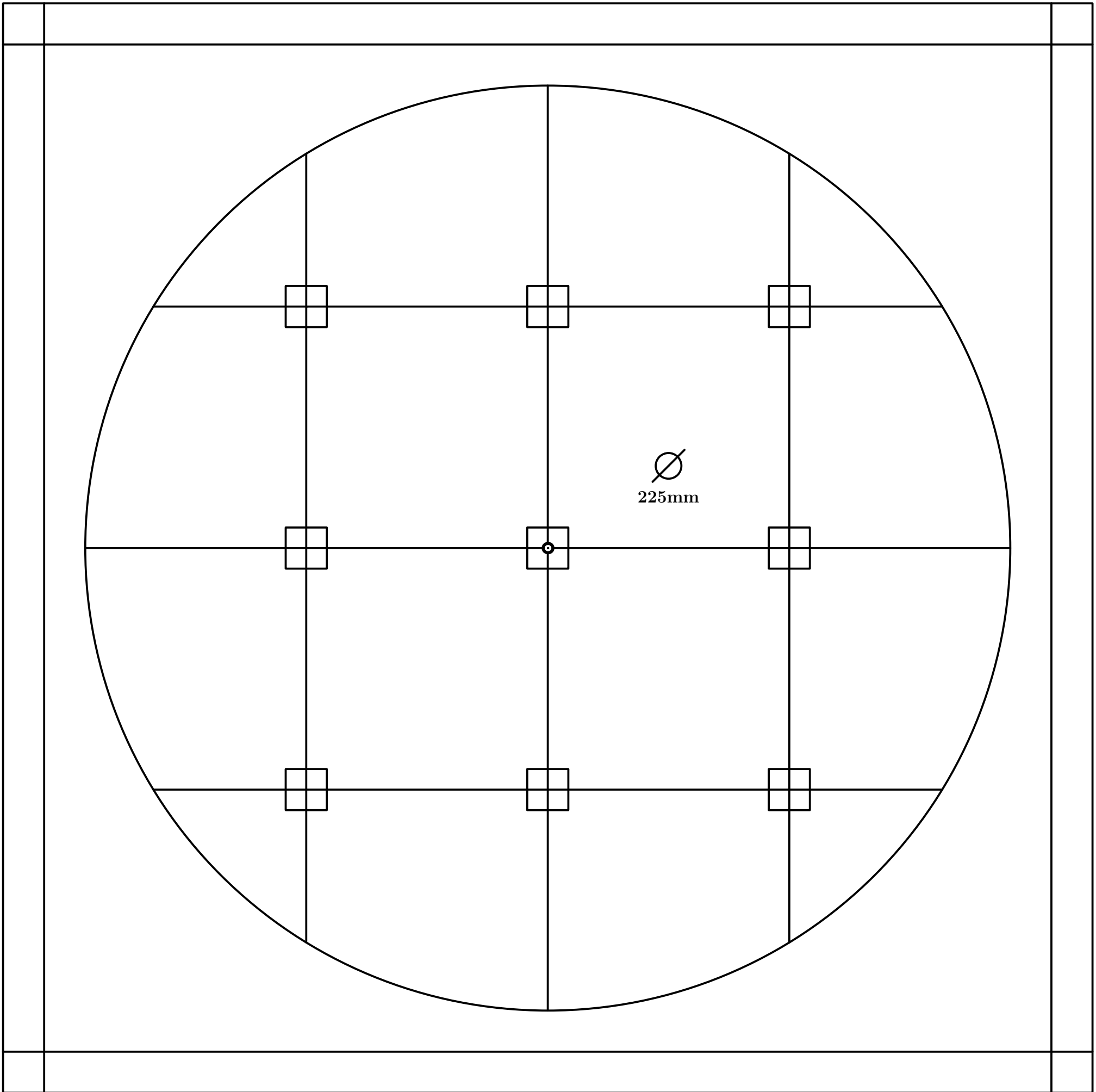

Fig. 501

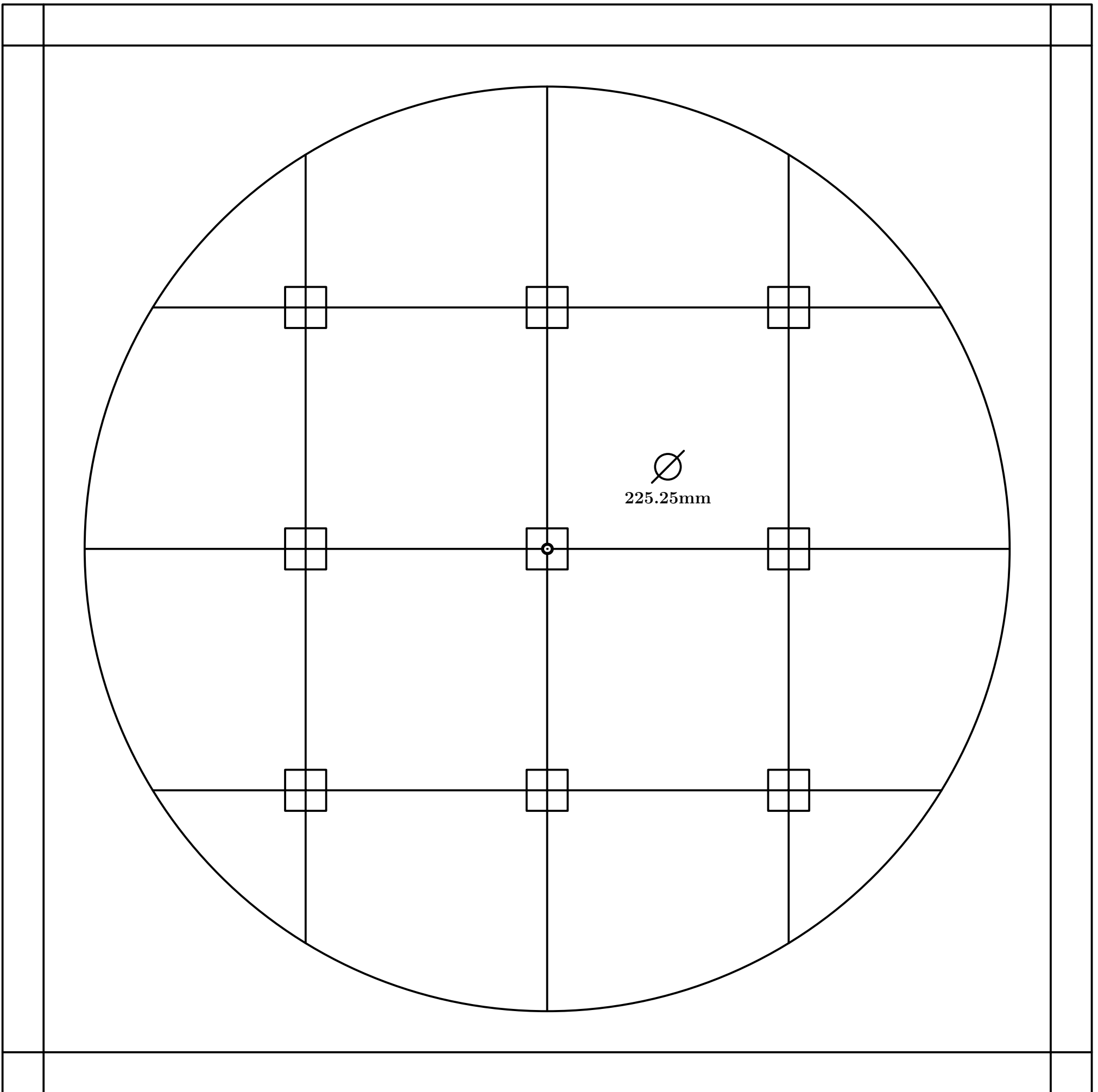

Fig. 502

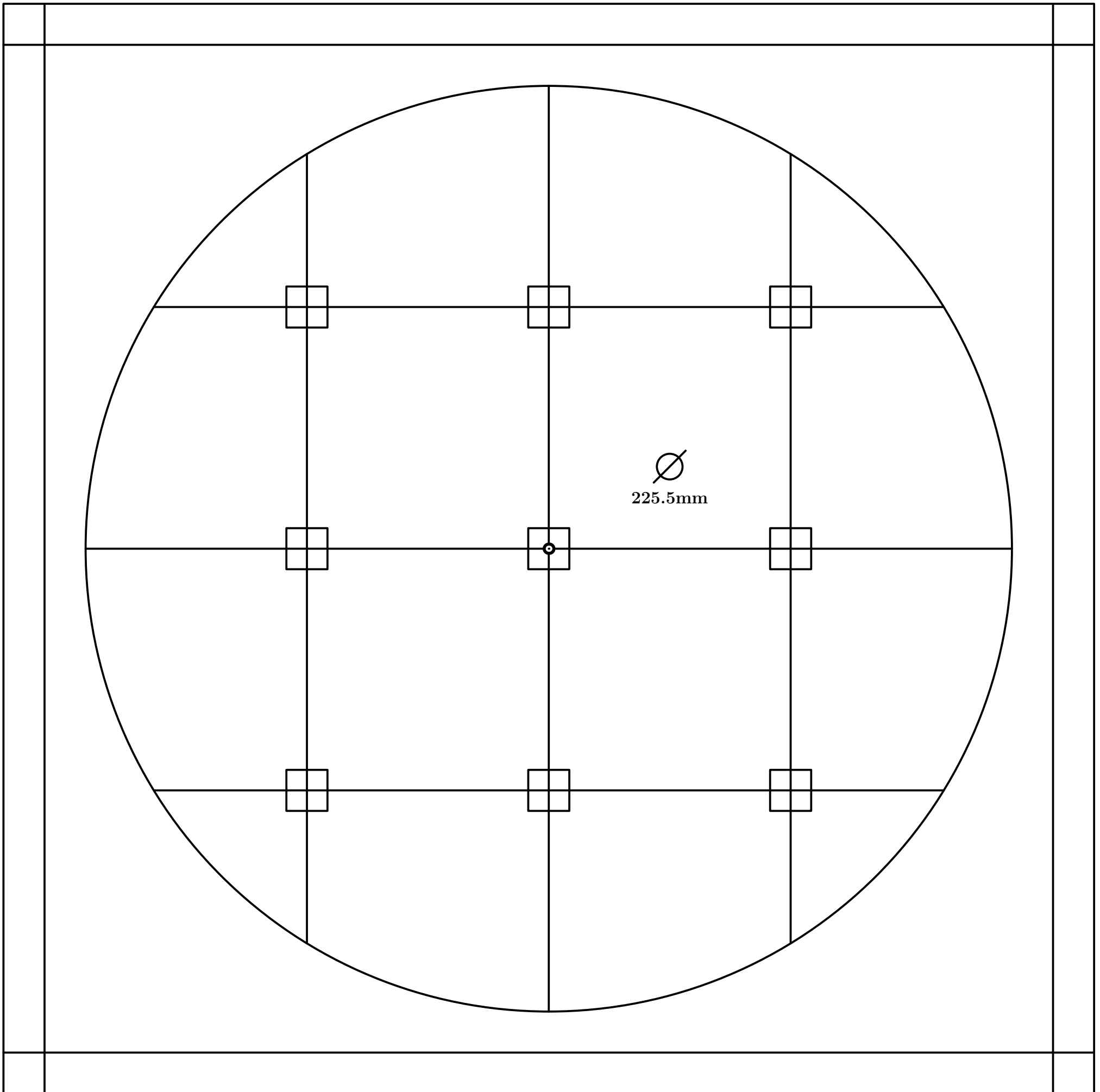

Fig. 503

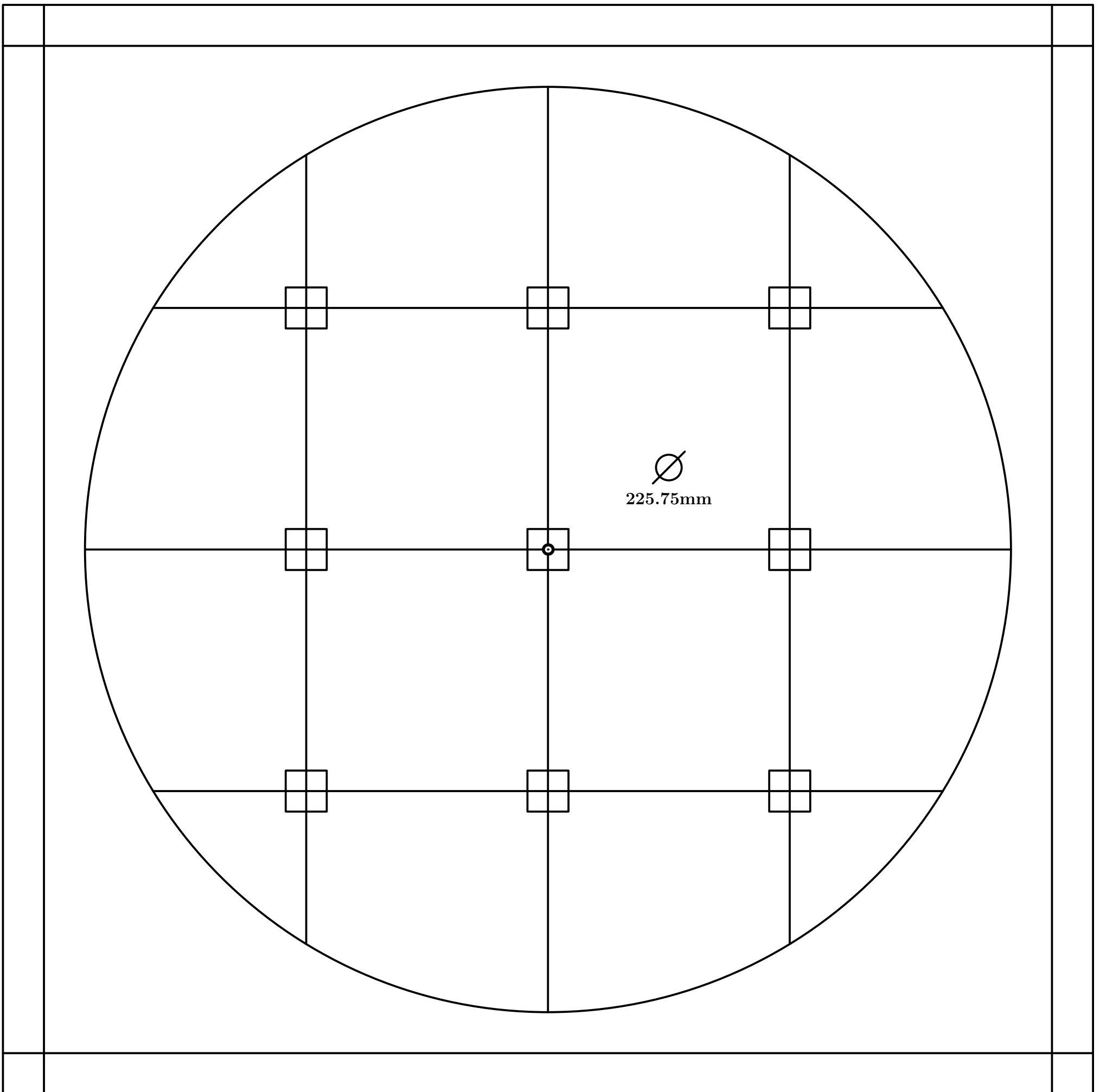

Fig. 504

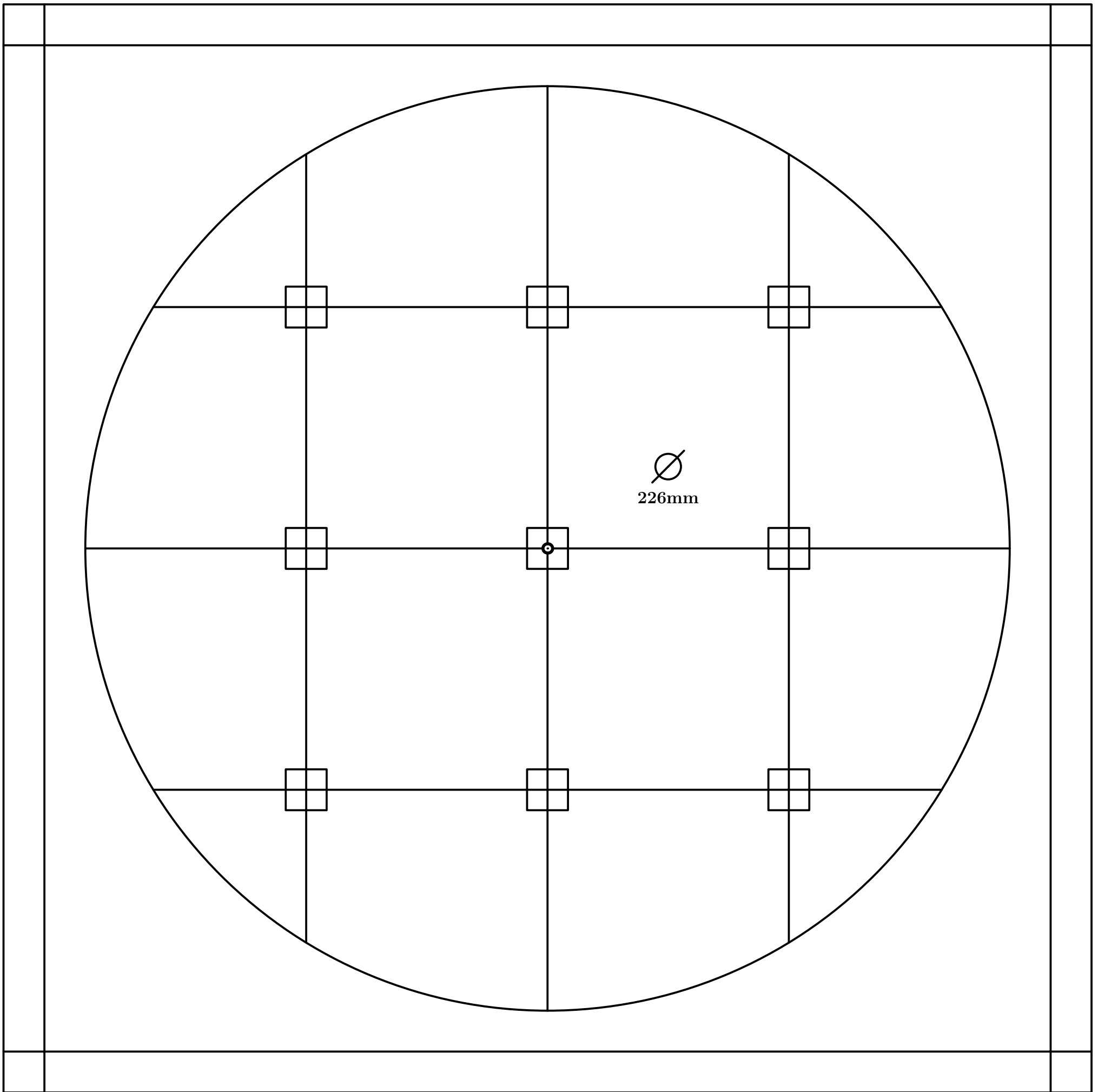

Fig. 505

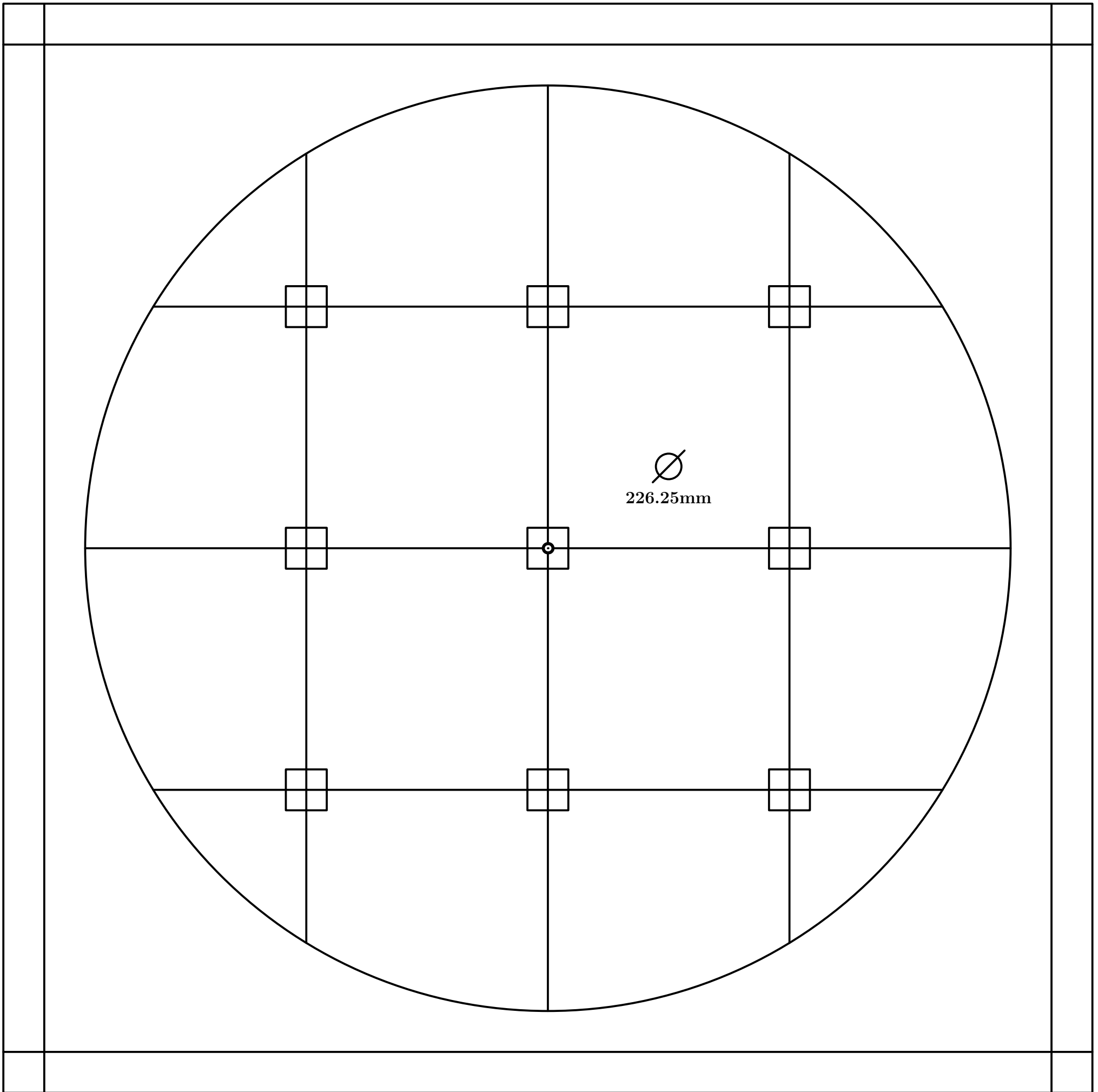

Fig. 506

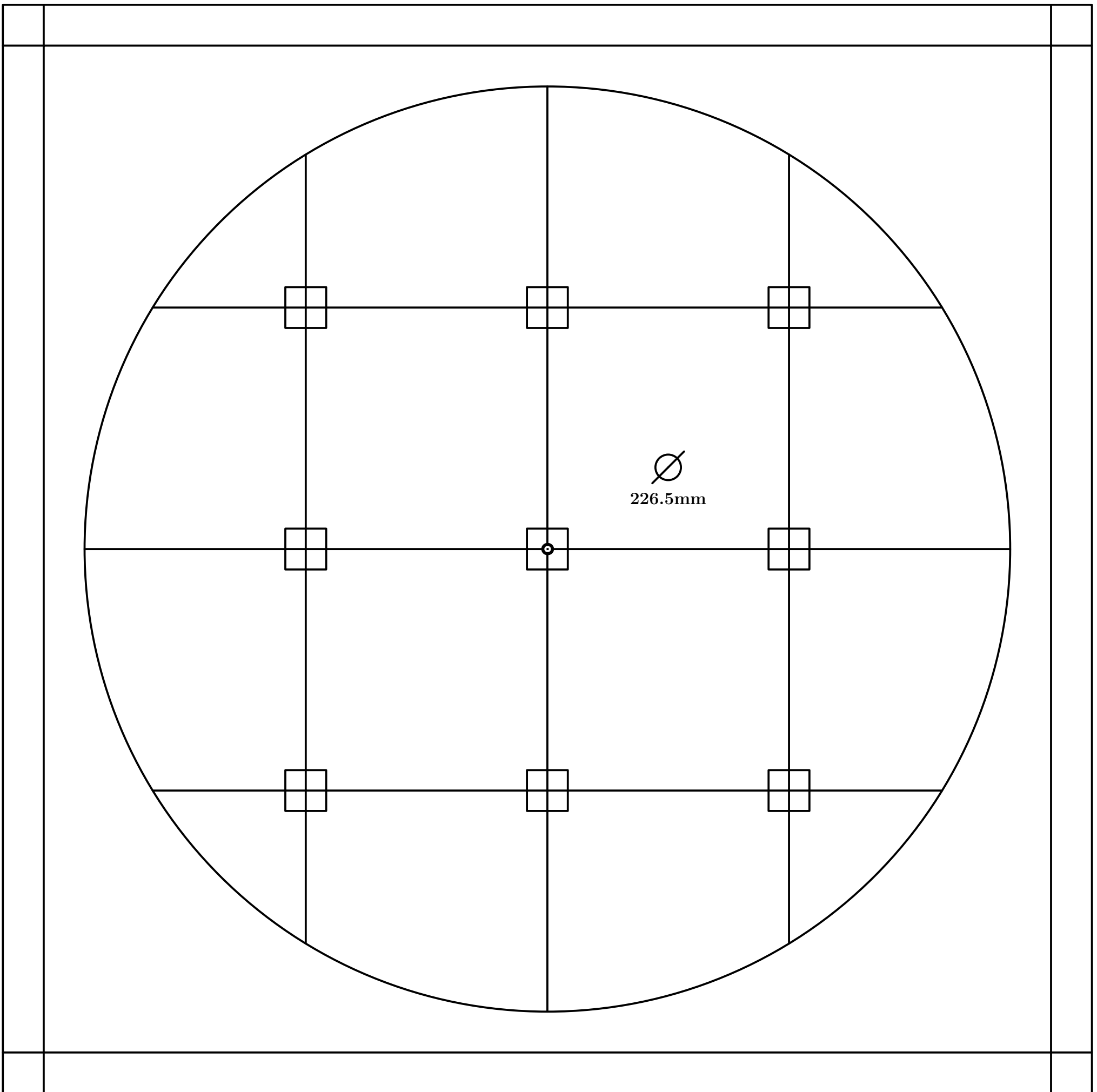

Fig. 507

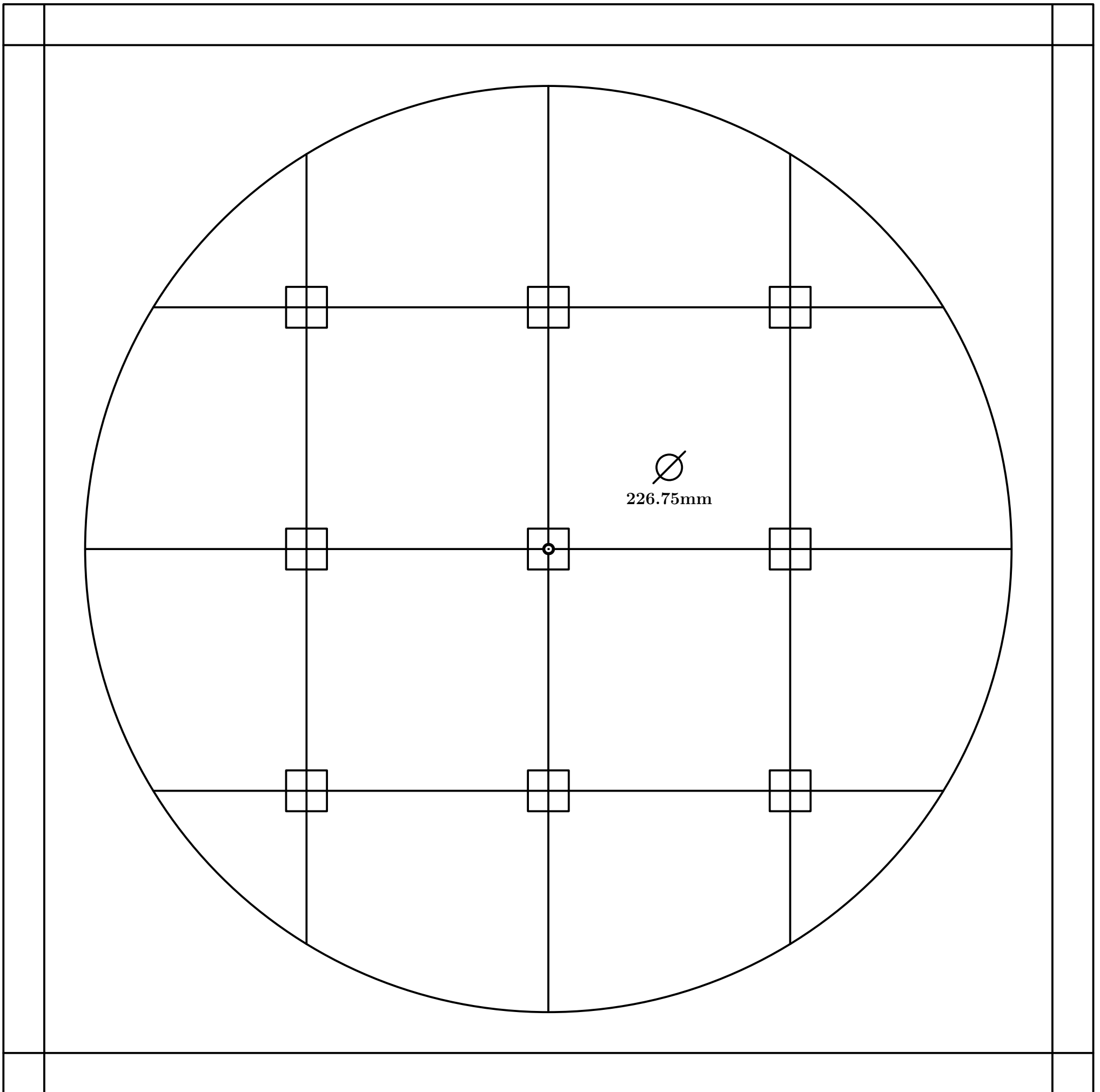

Fig. 508

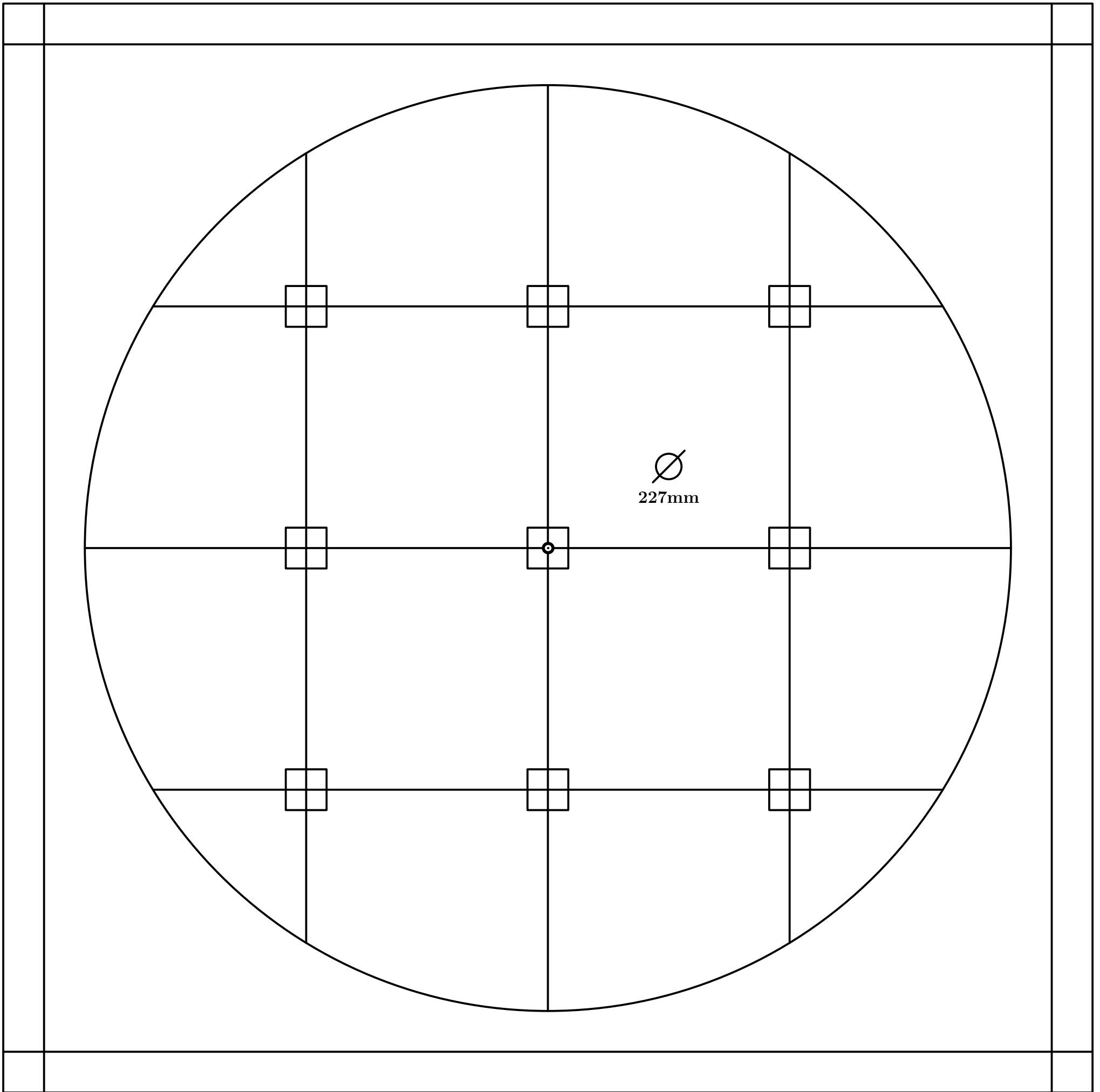

Fig. 509

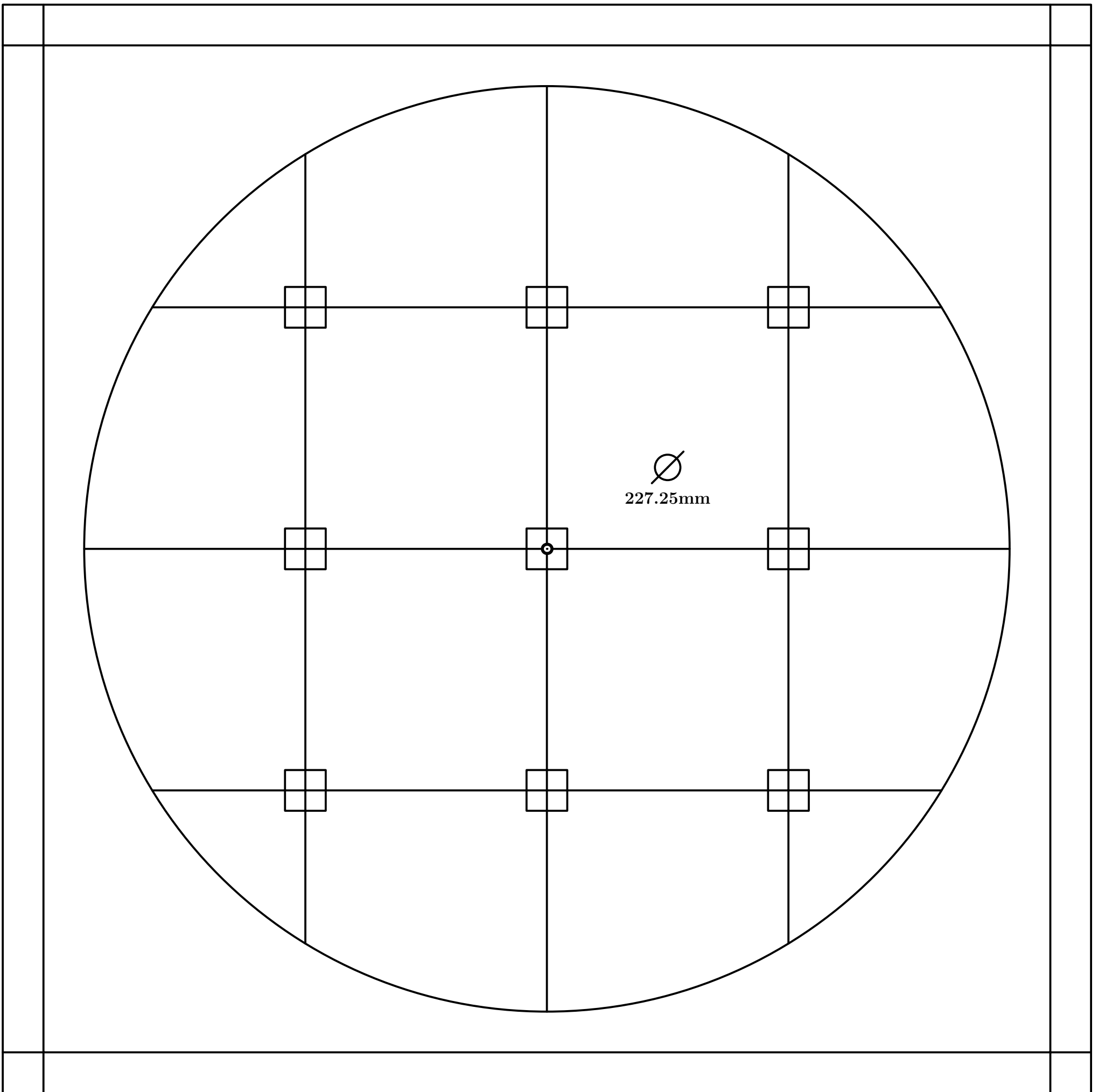

Fig. 510

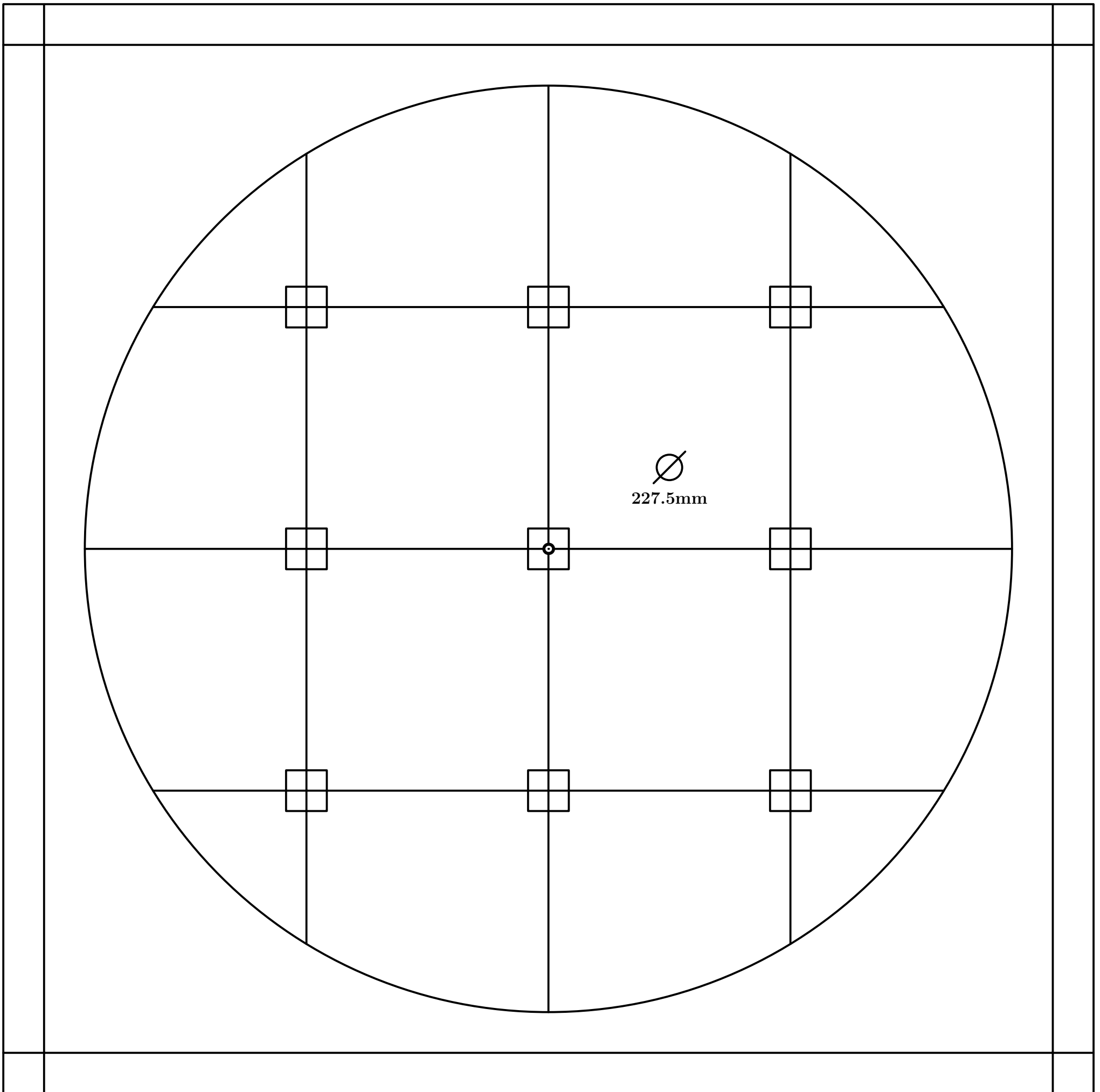

Fig. 511

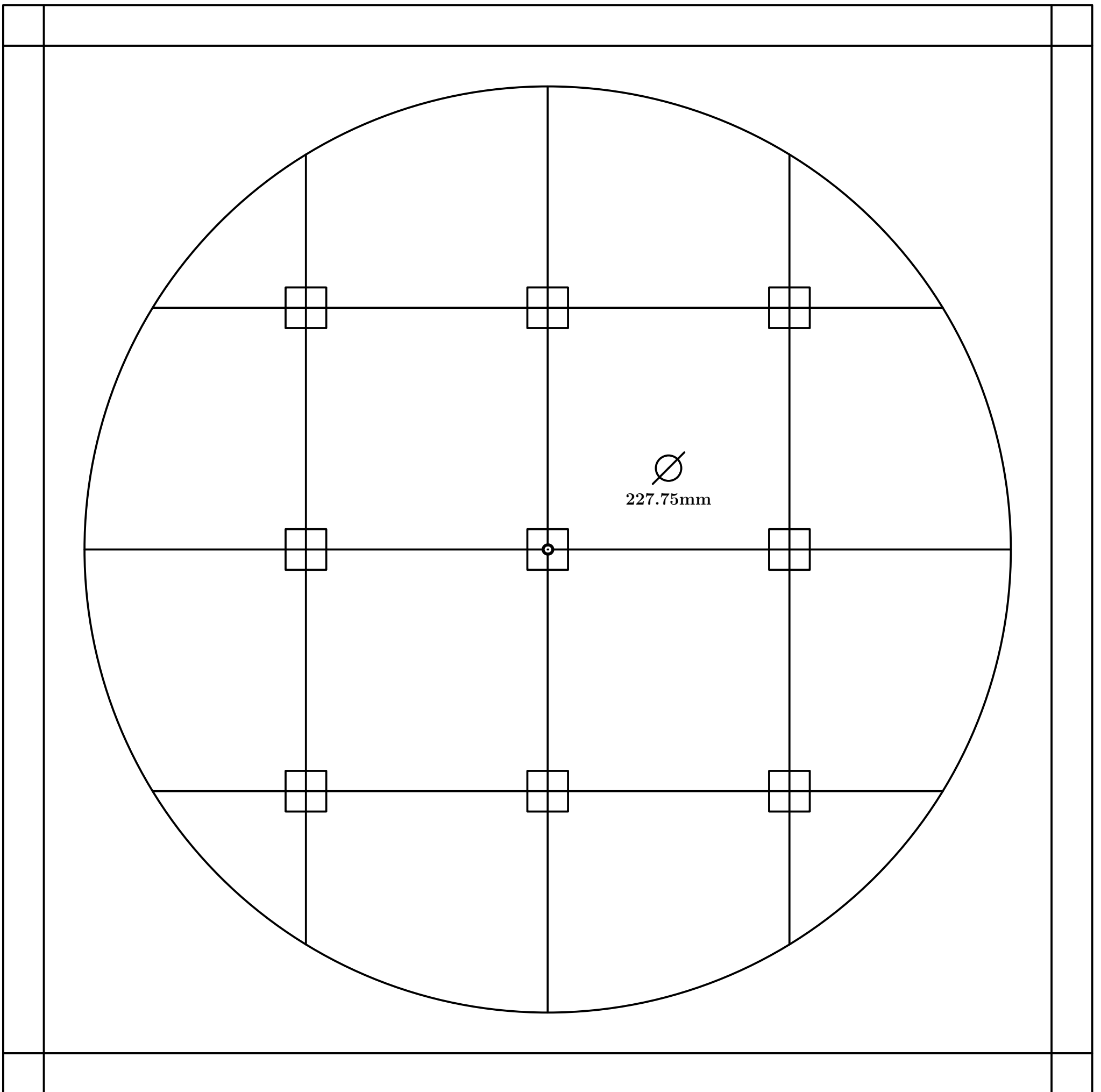

Fig. 512

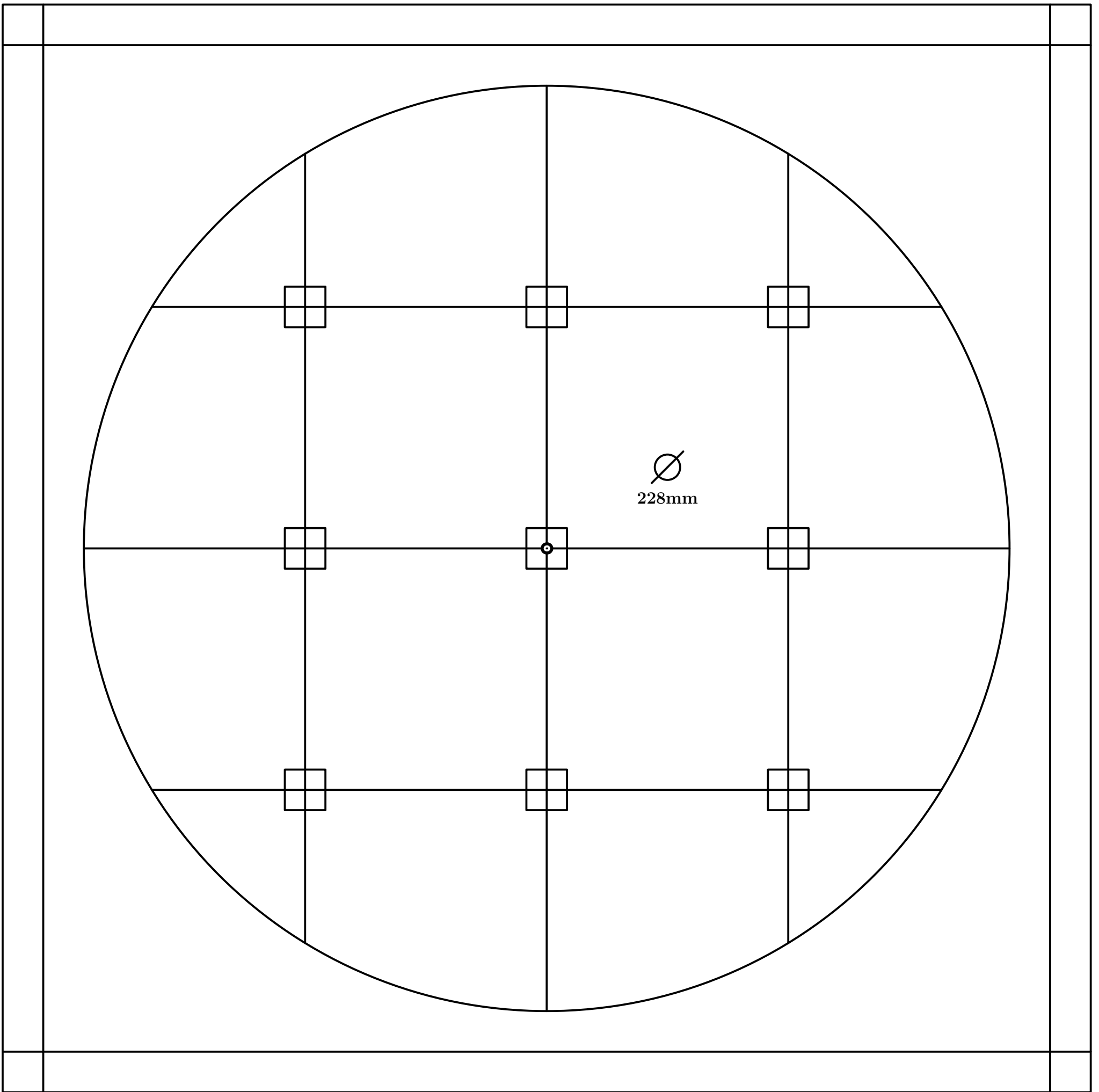

Fig. 513

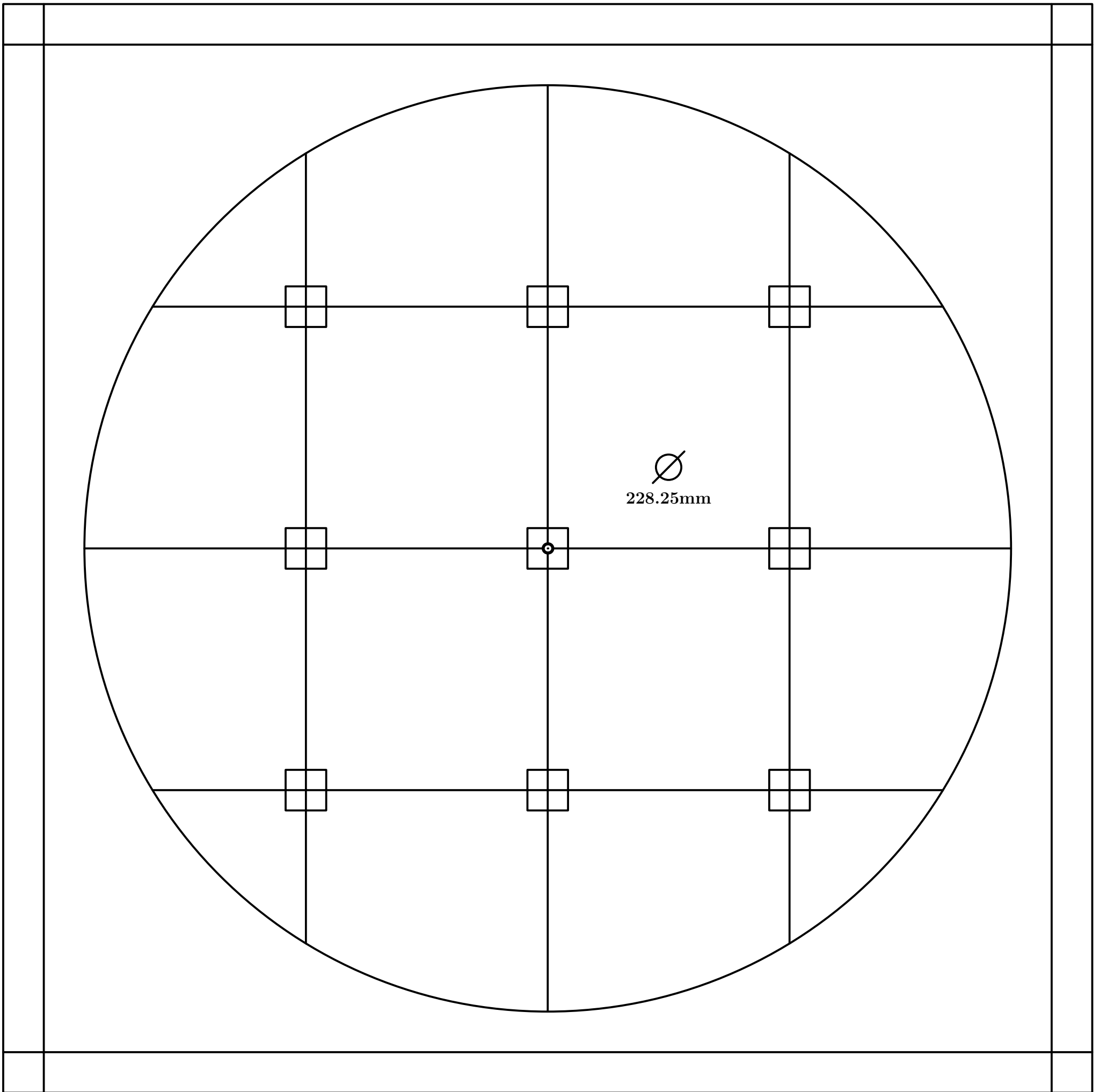

Fig. 514

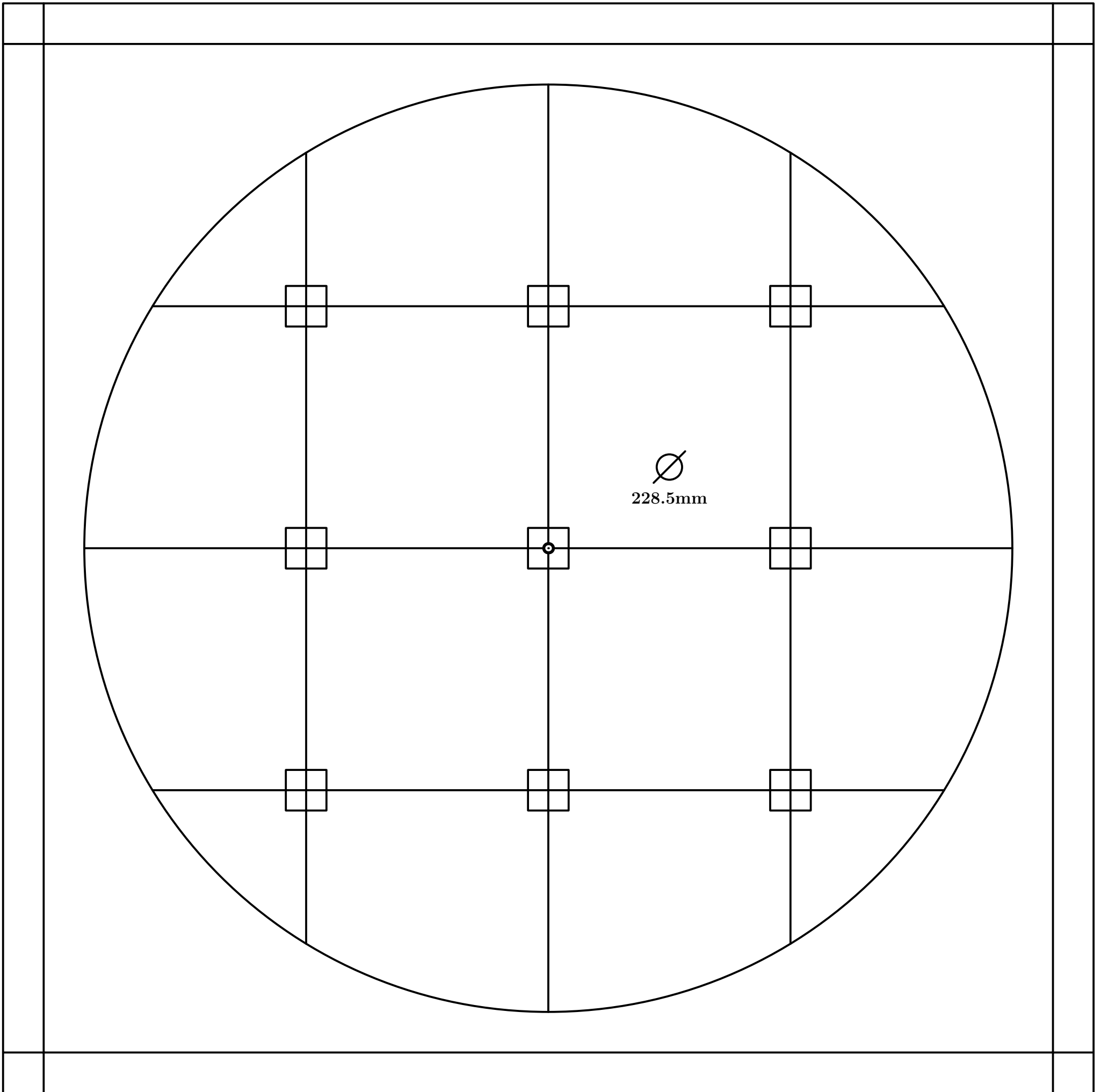

Fig. 515

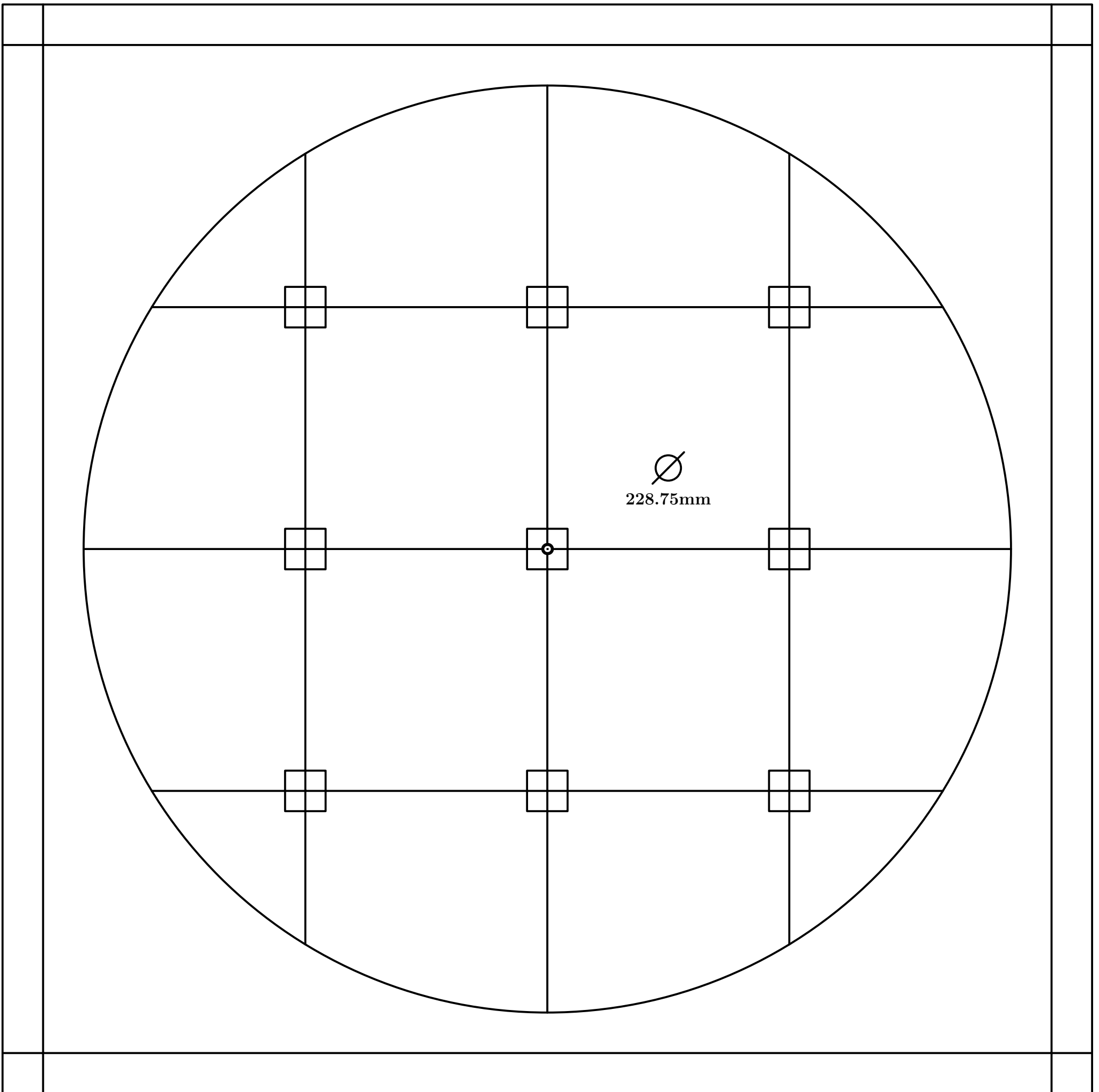

Fig. 516

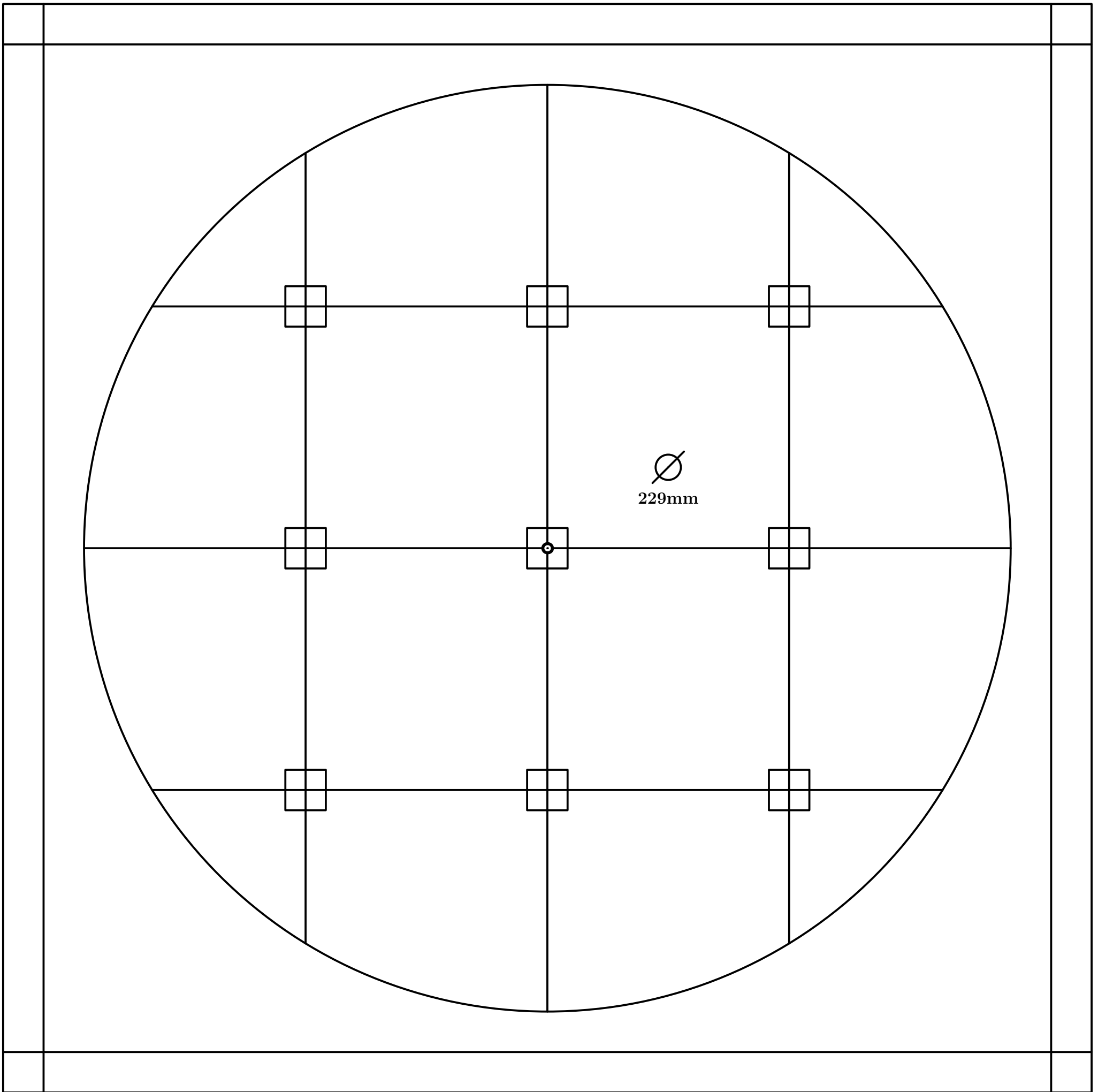

Fig. 517

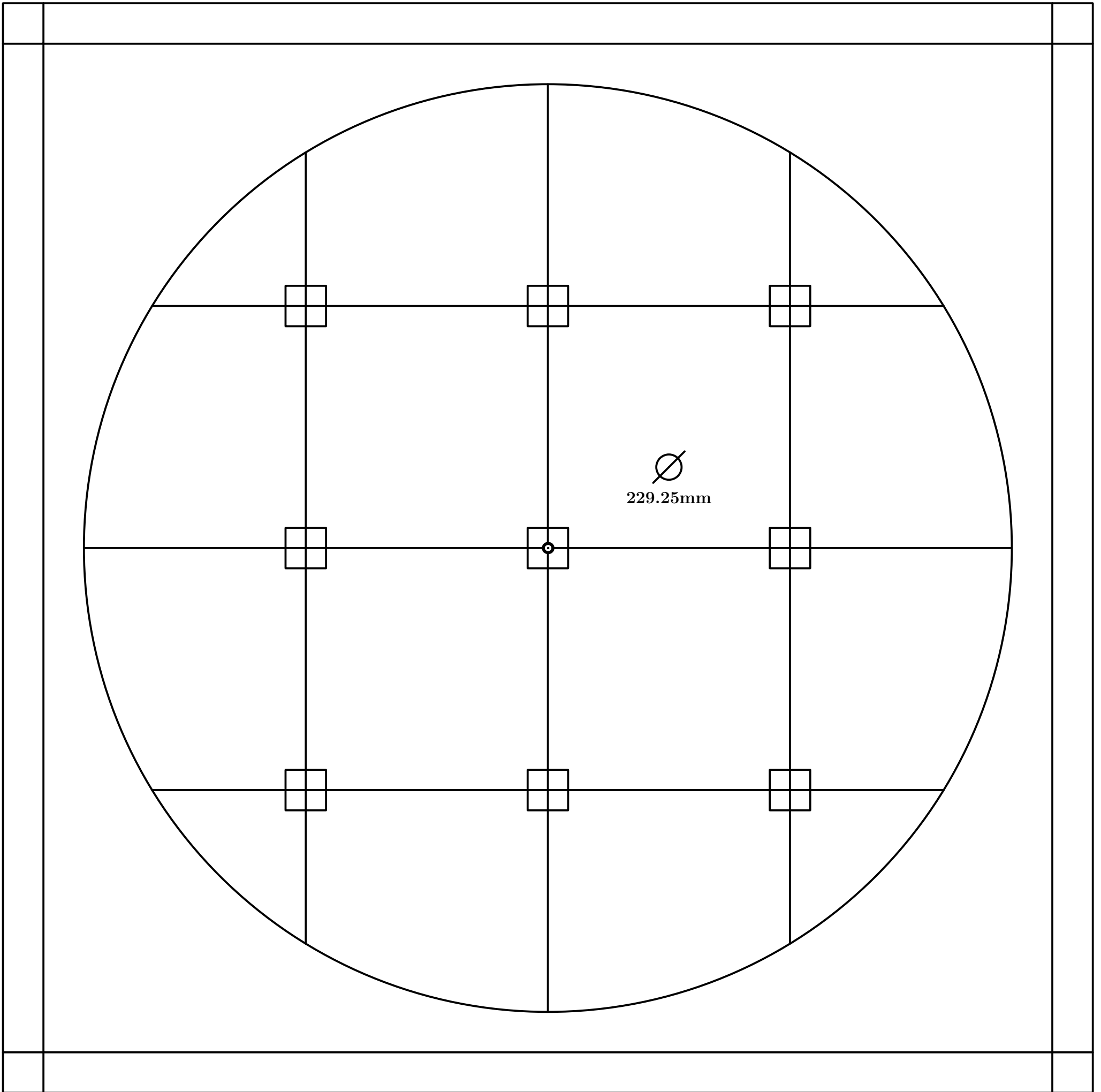

Fig. 518

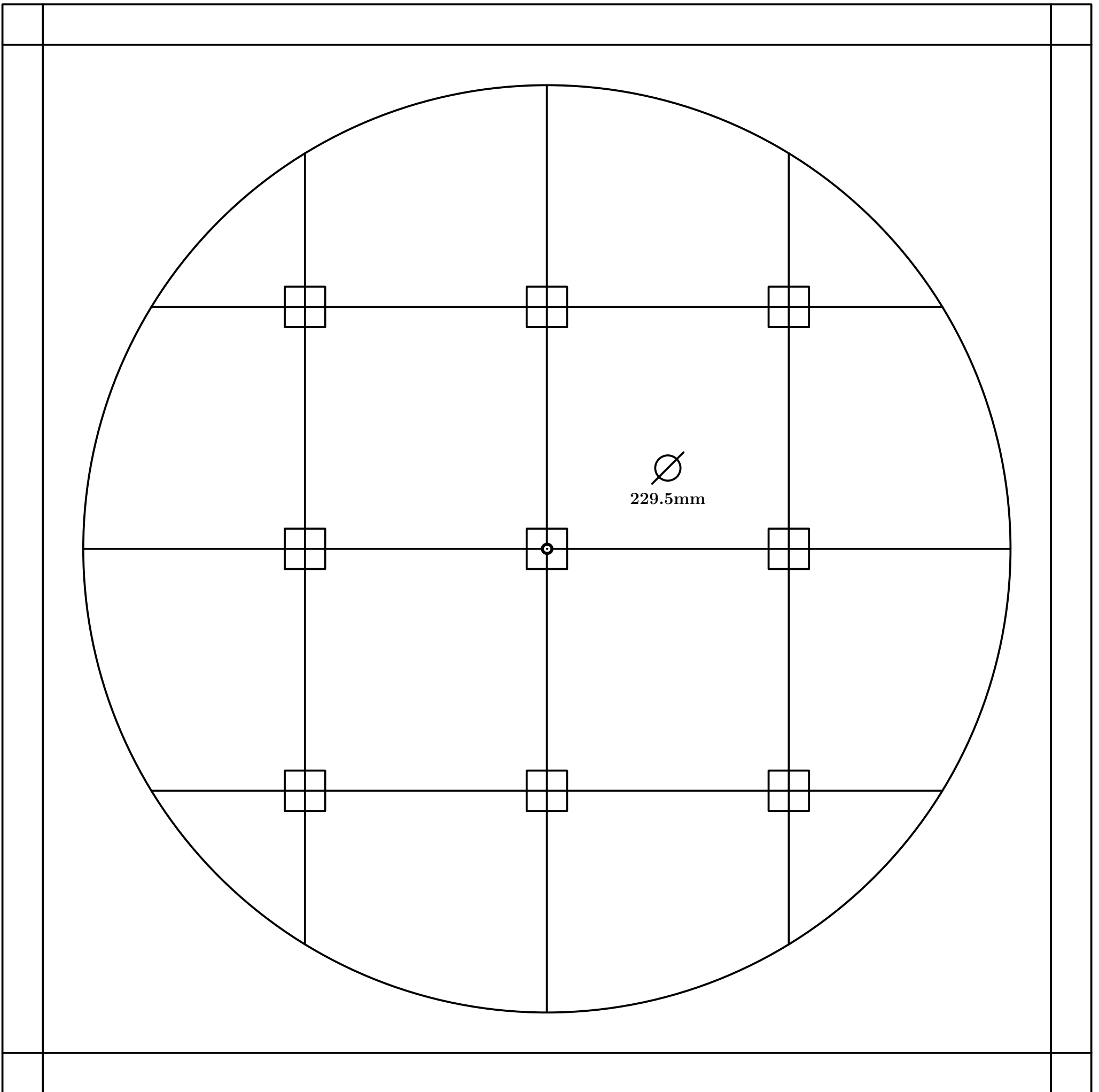

Fig. 519

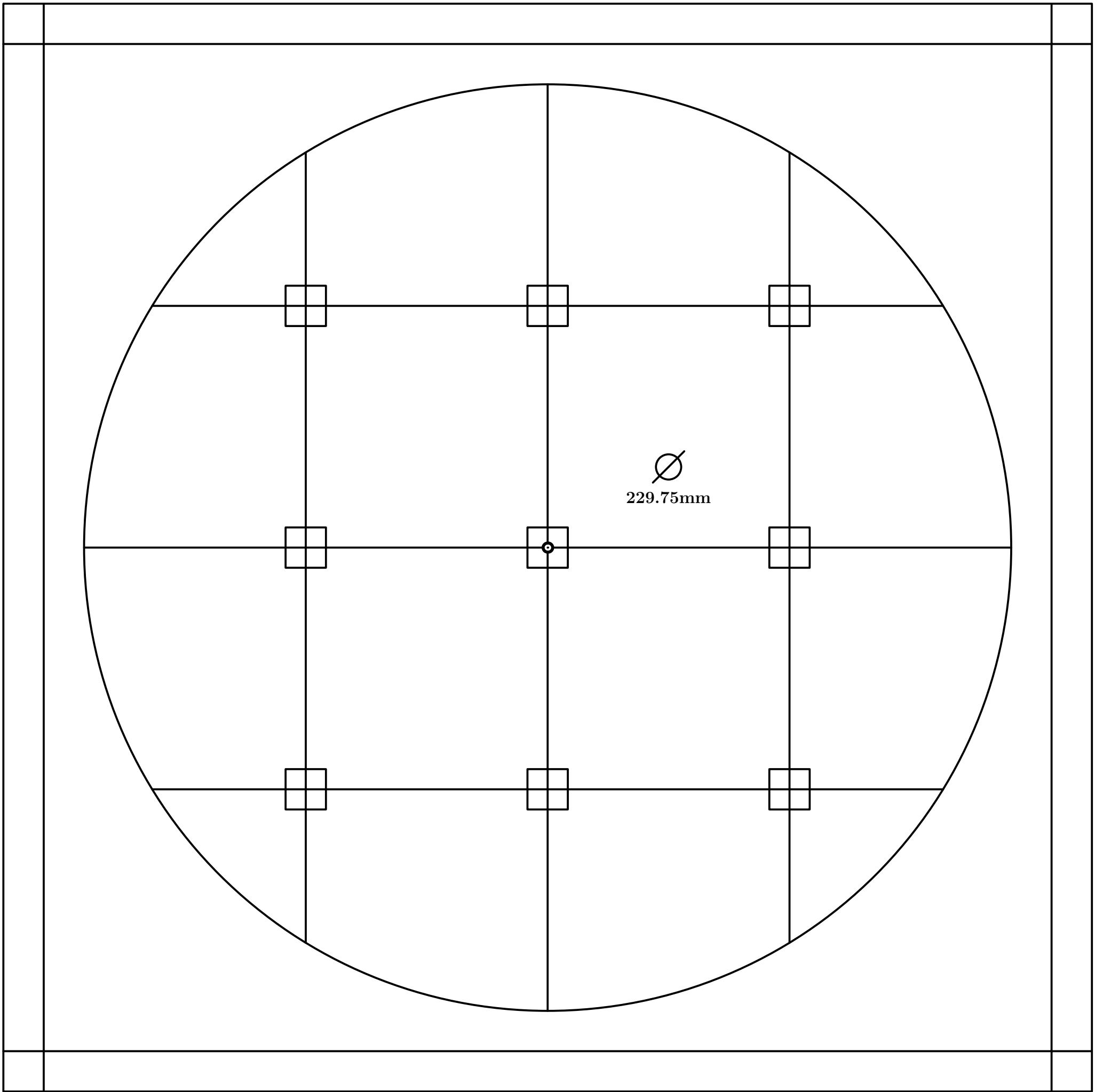

Fig. 520

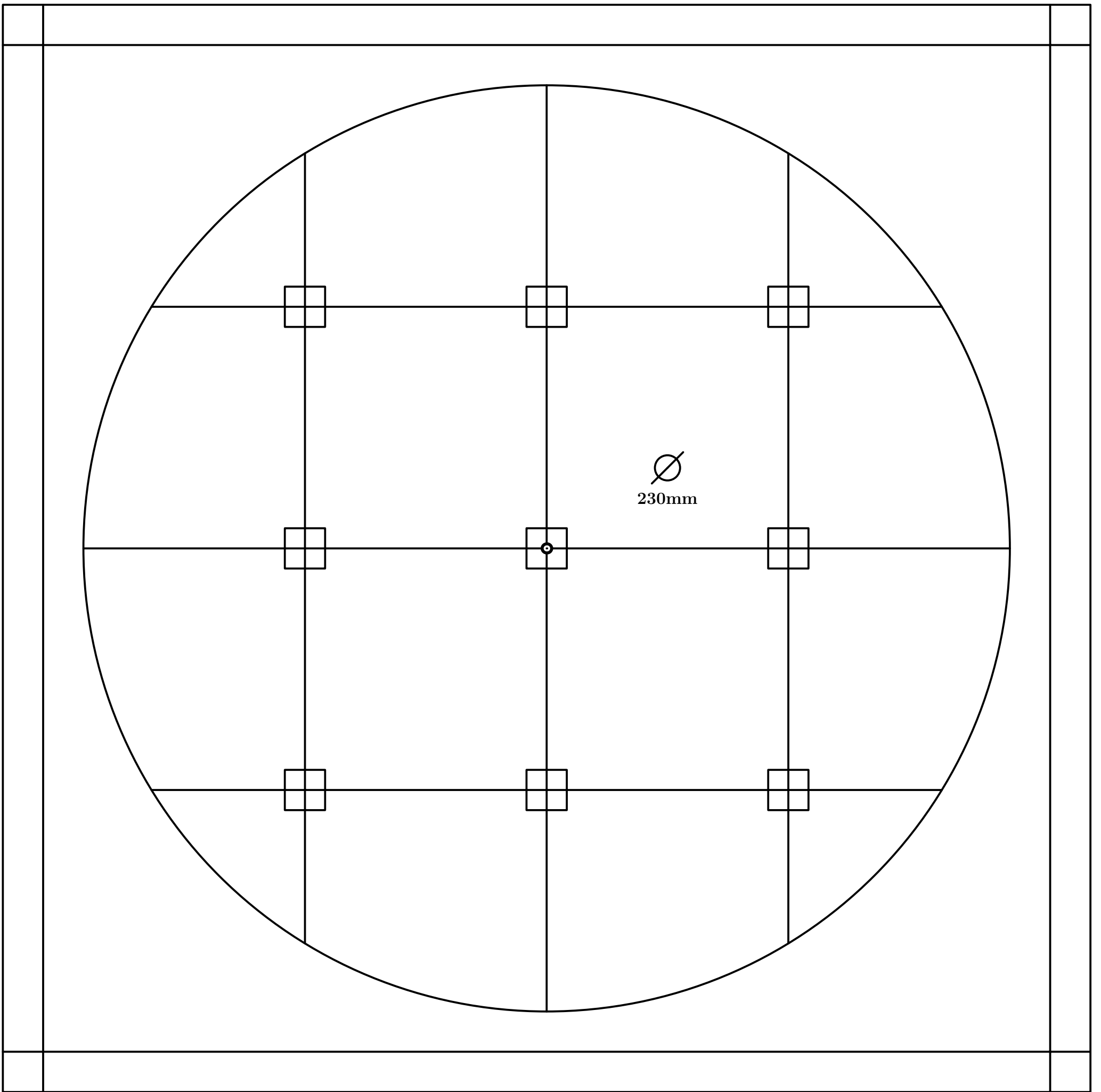

Fig. 521

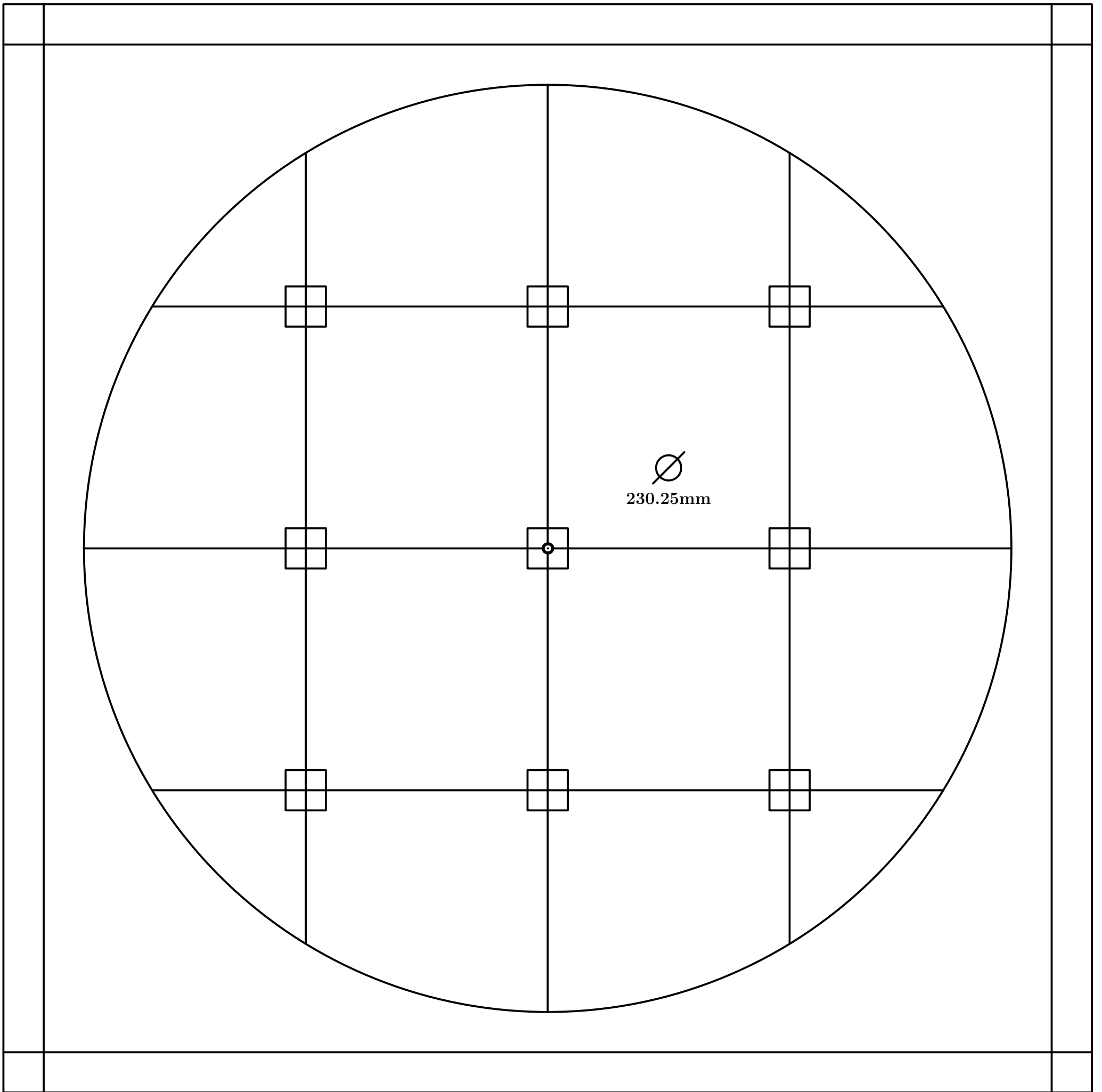

Fig. 522

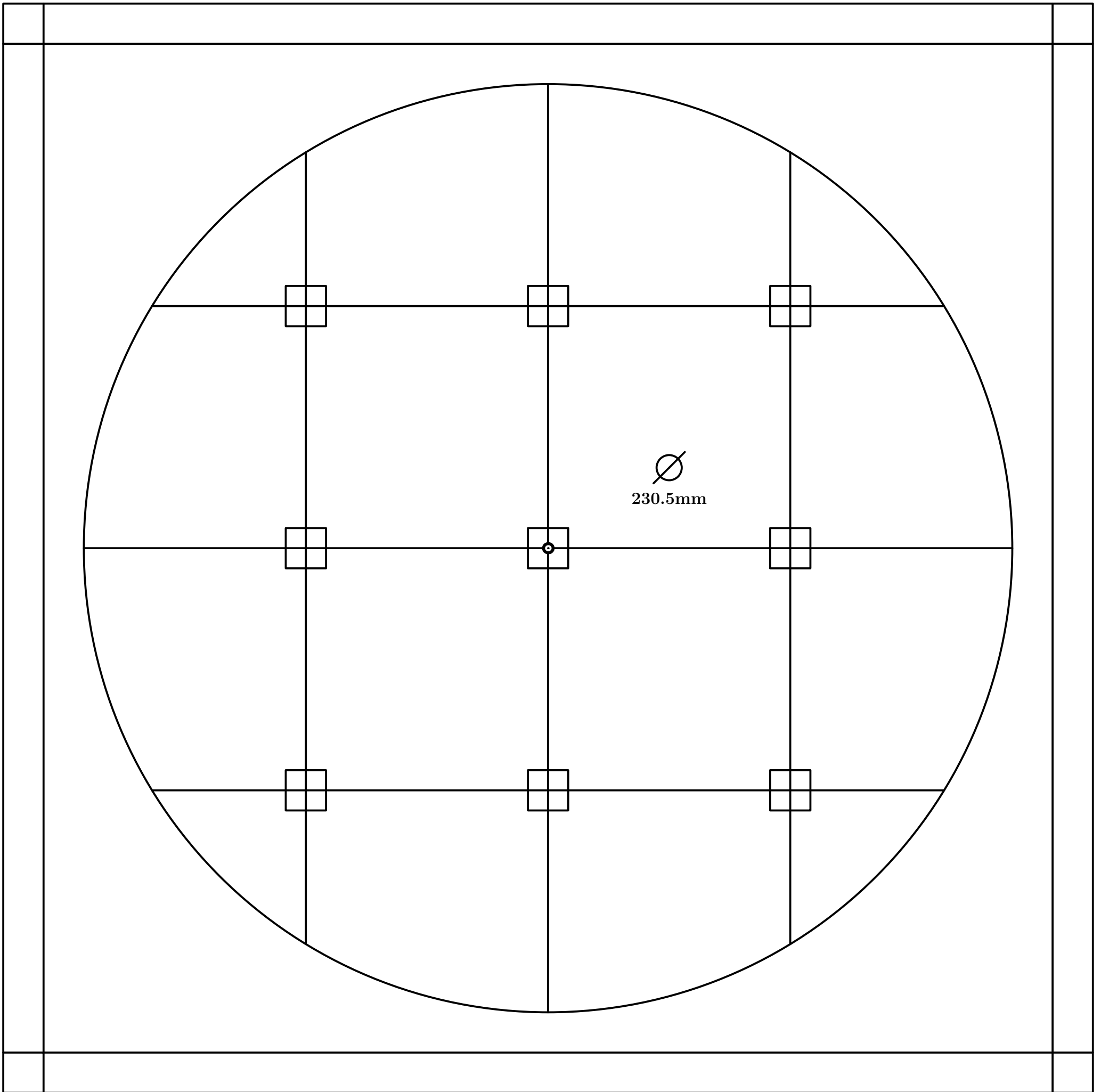

Fig. 523

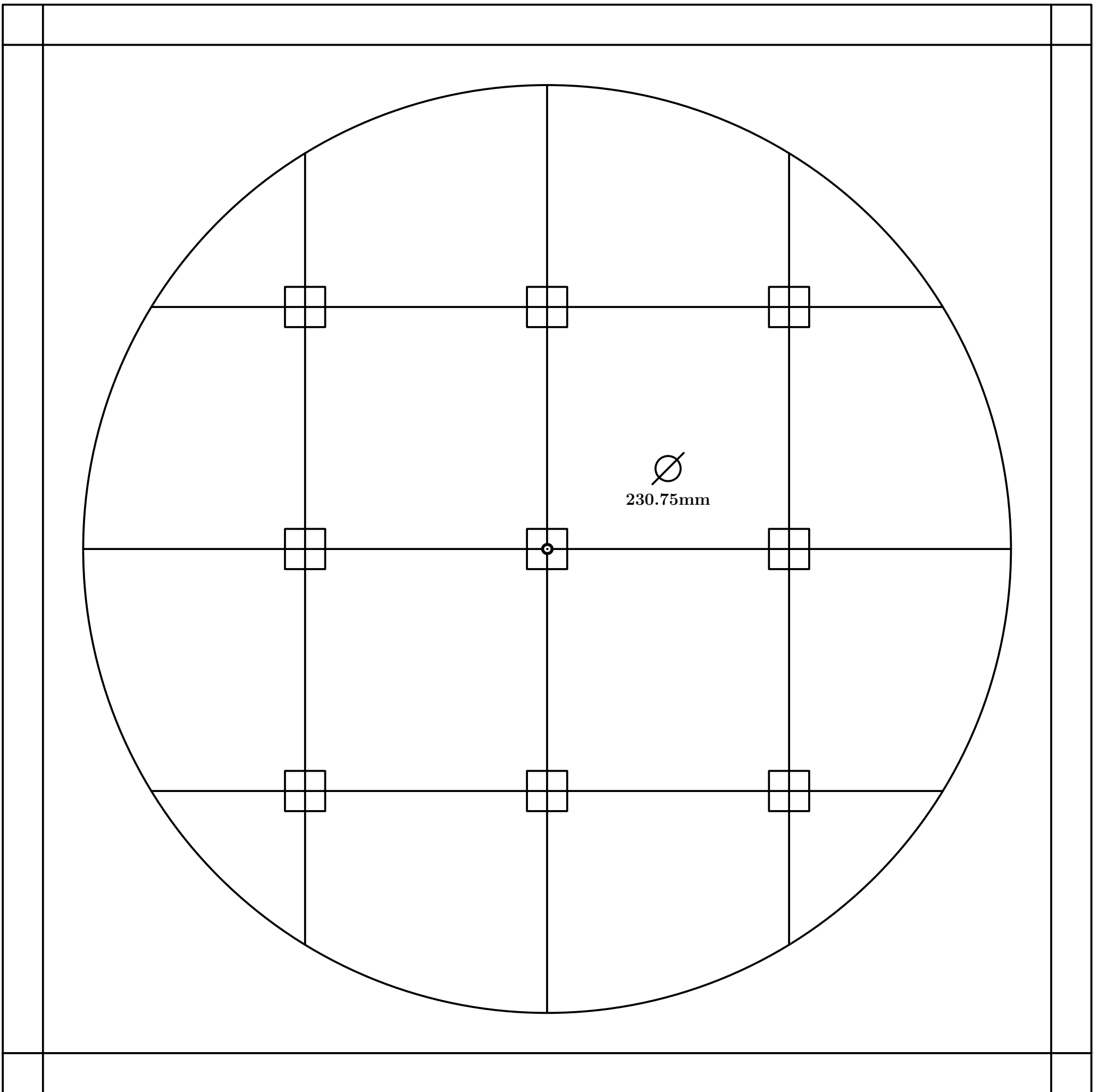

Fig. 524

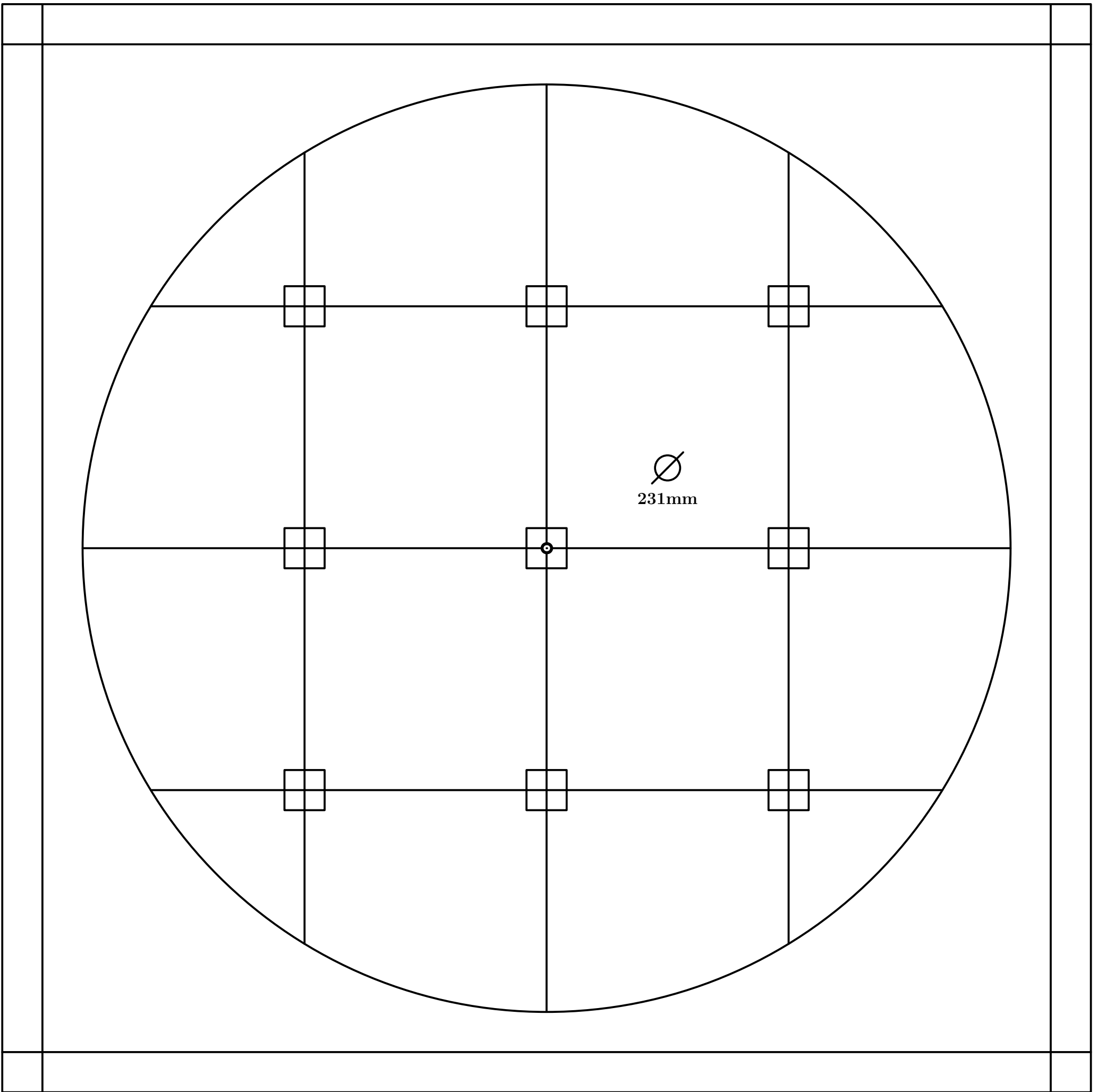

Fig. 525

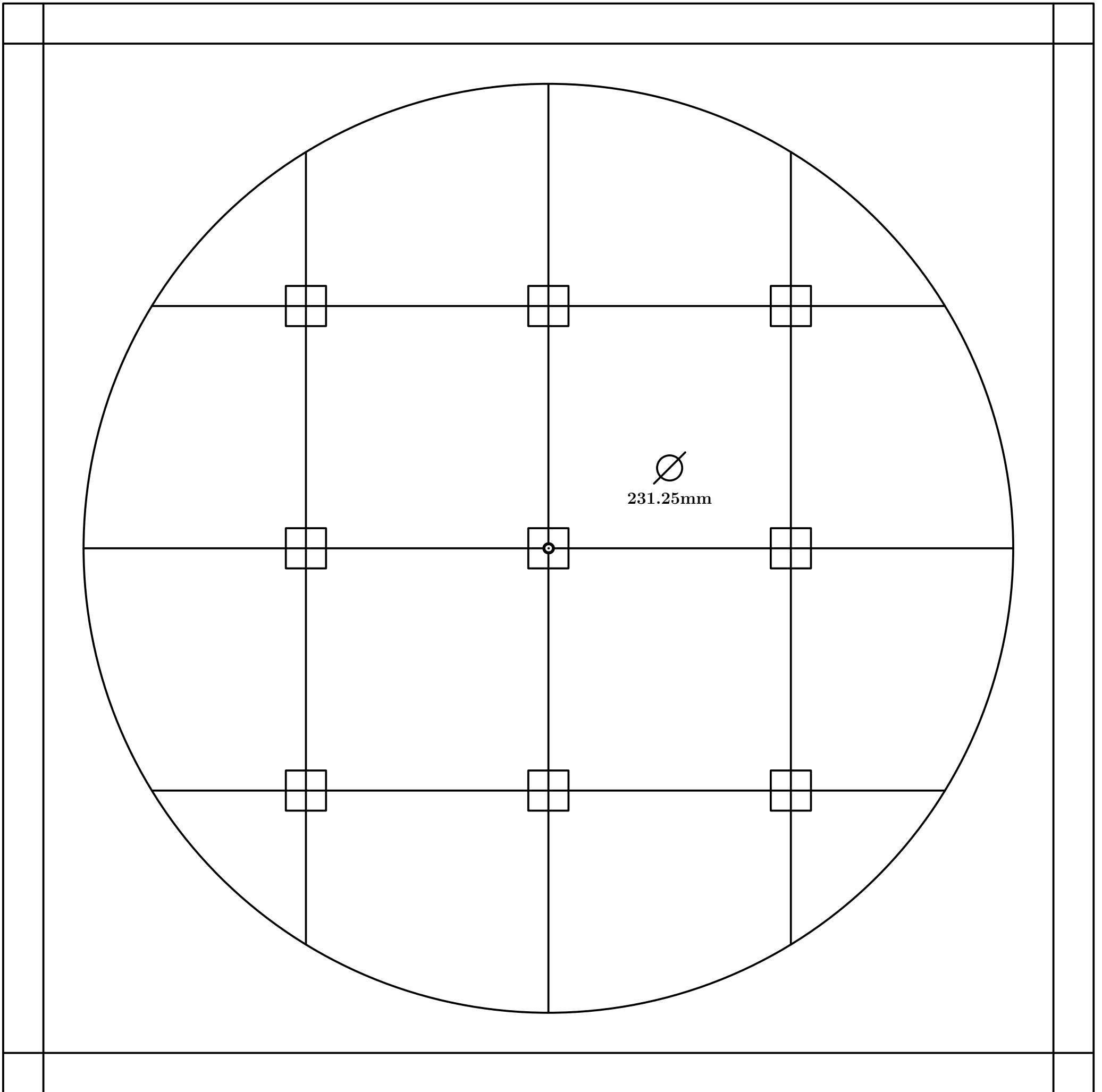

Fig. 526

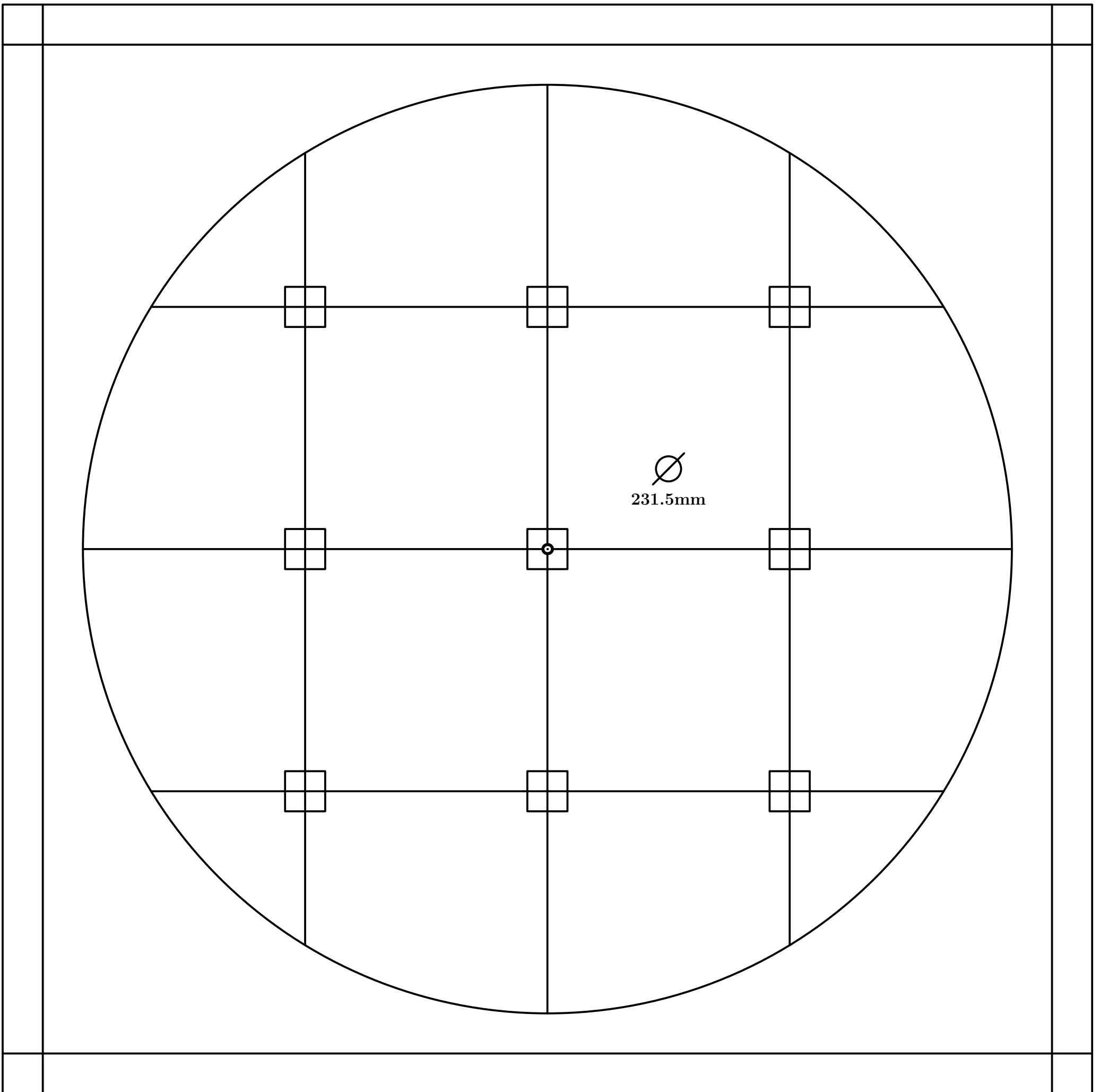

Fig. 527

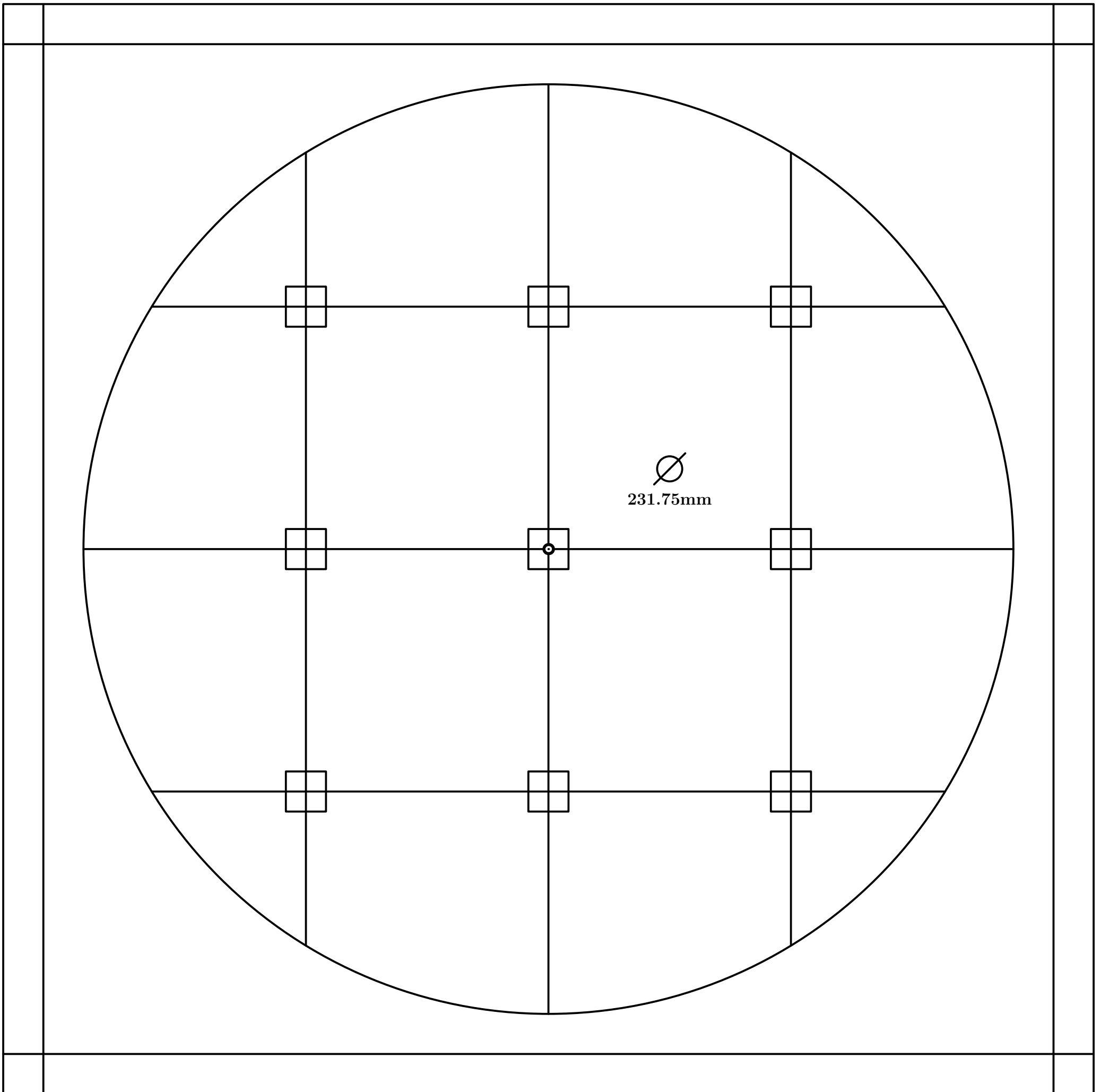

Fig. 528

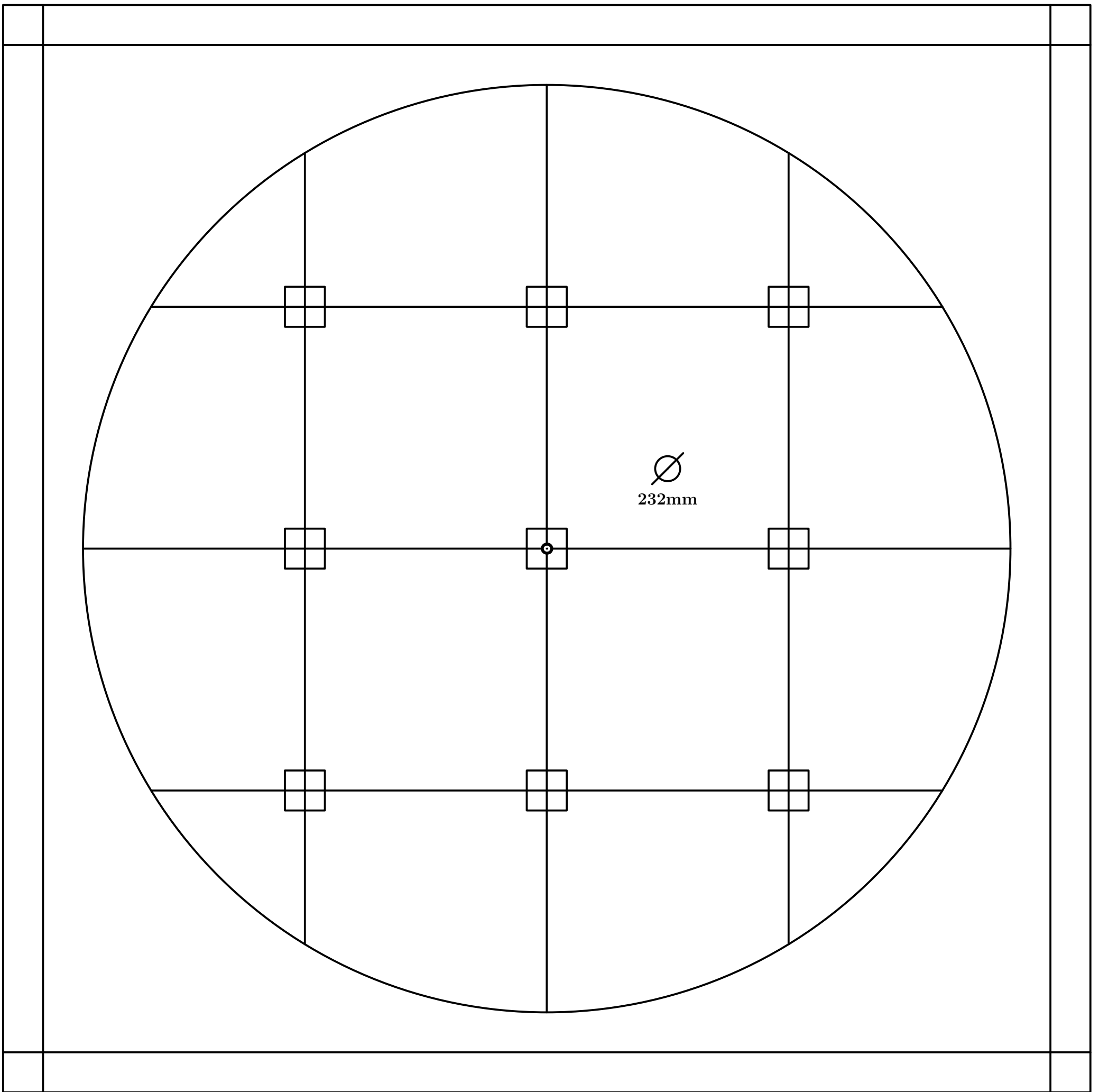

Fig. 529

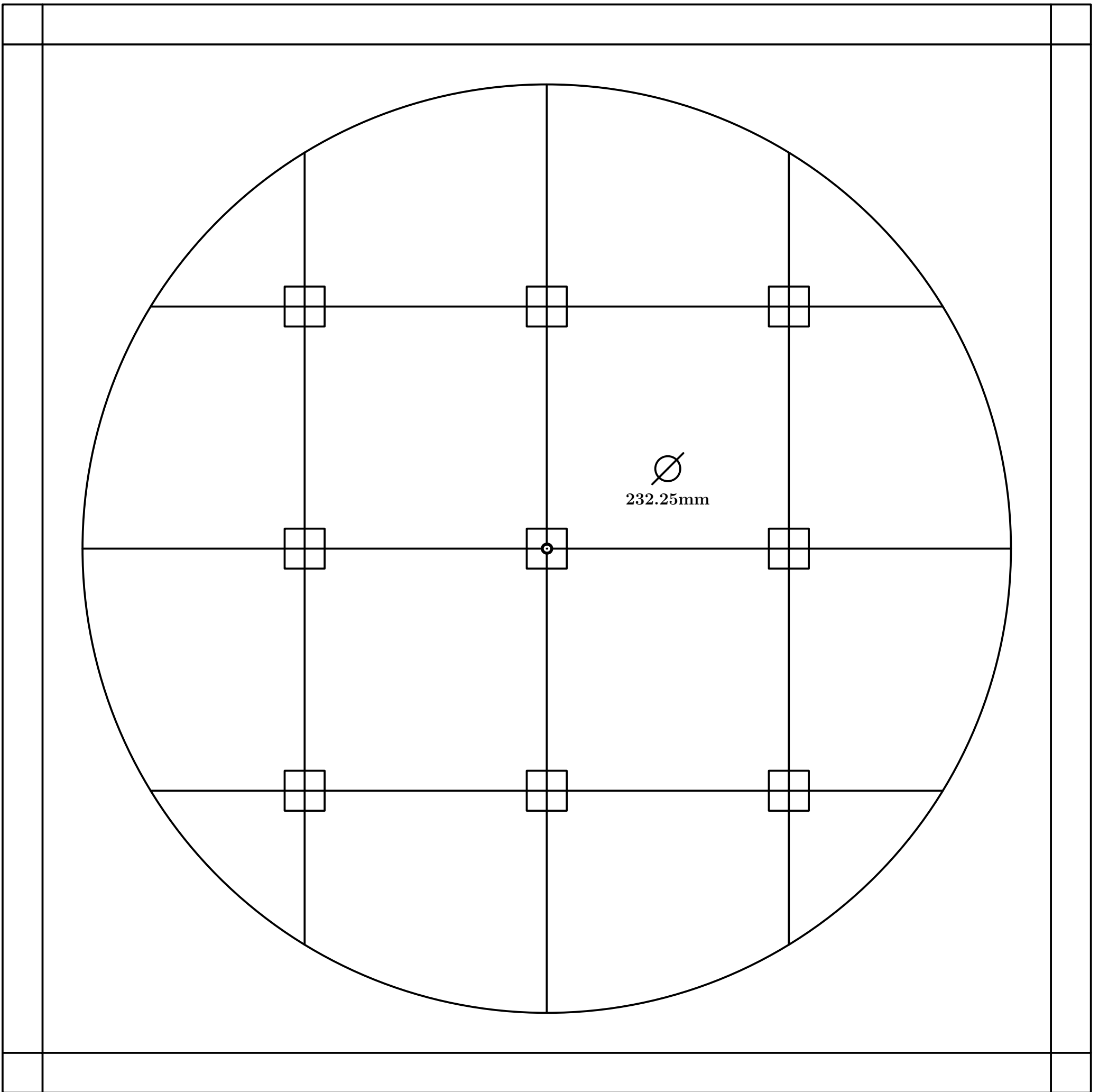

Fig. 530

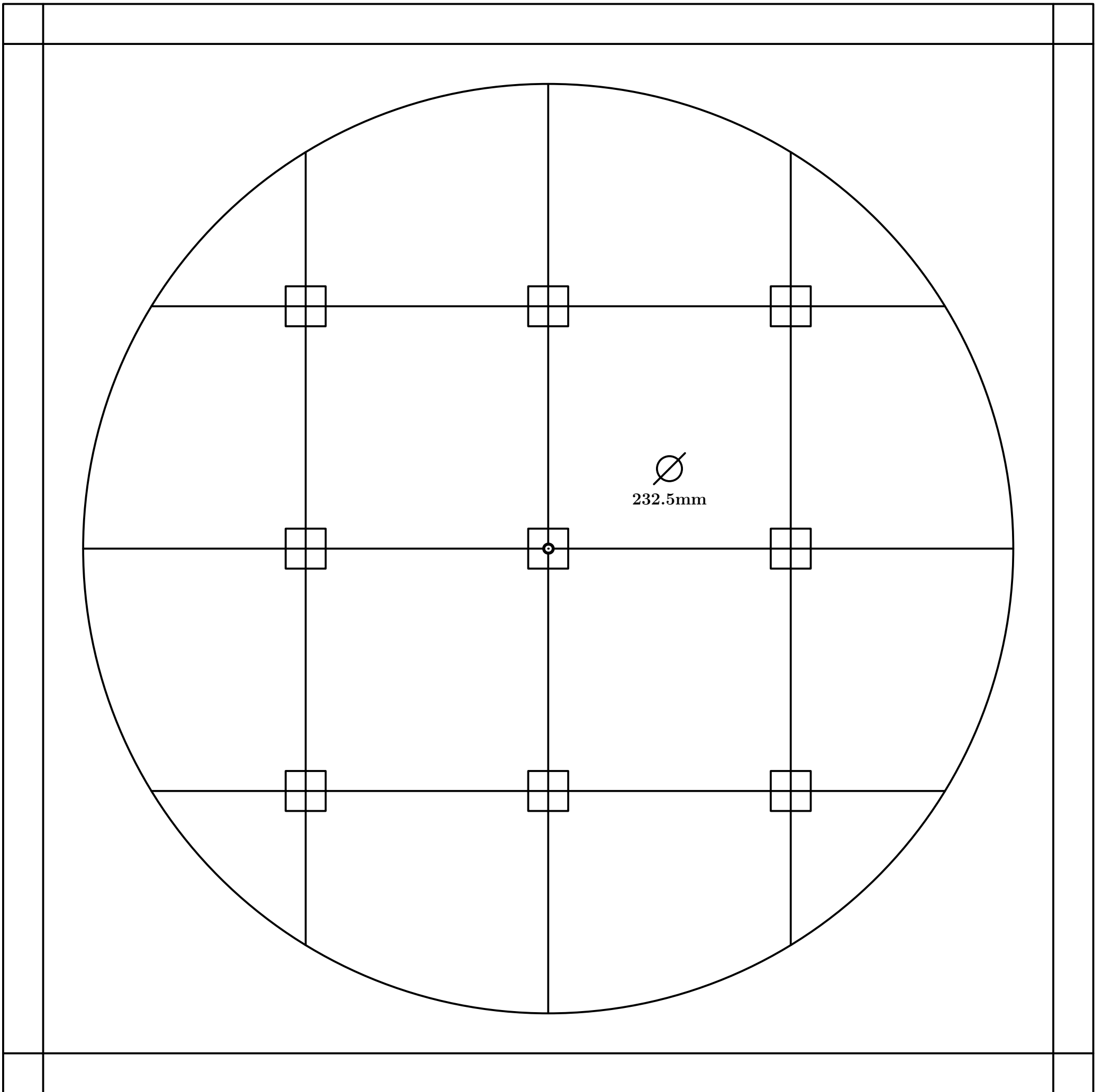

Fig. 531

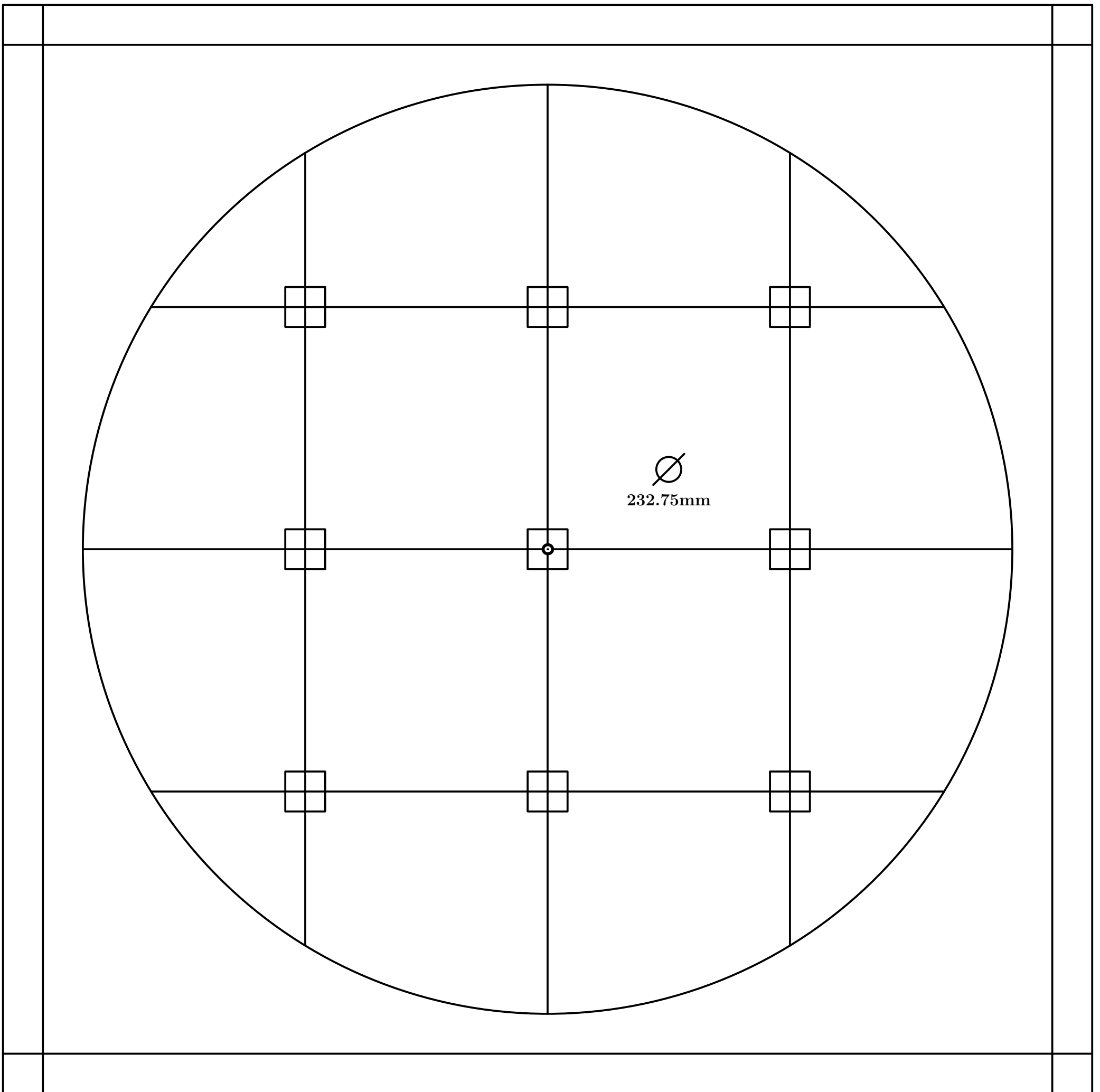

Fig. 532

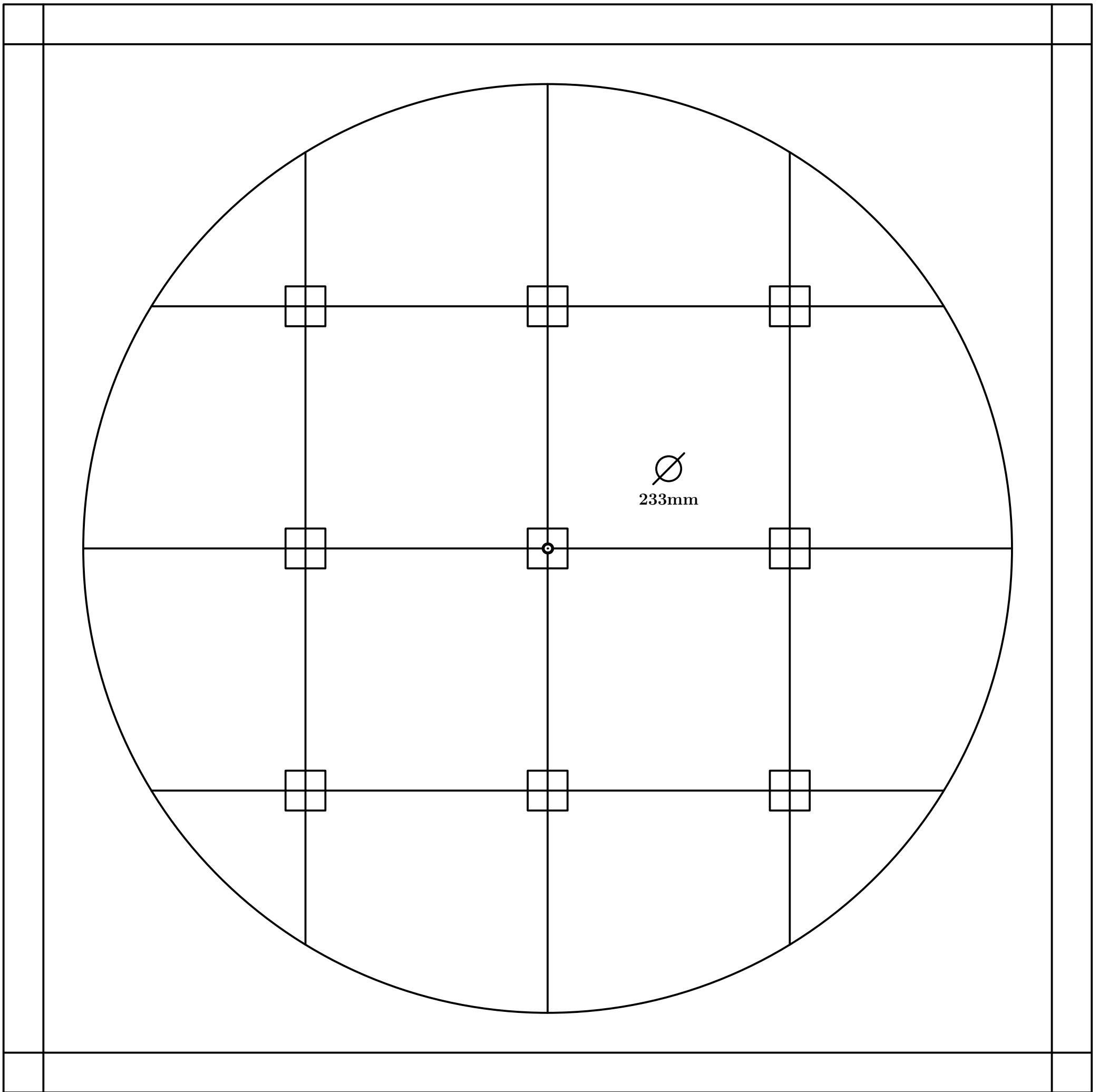

Fig. 533

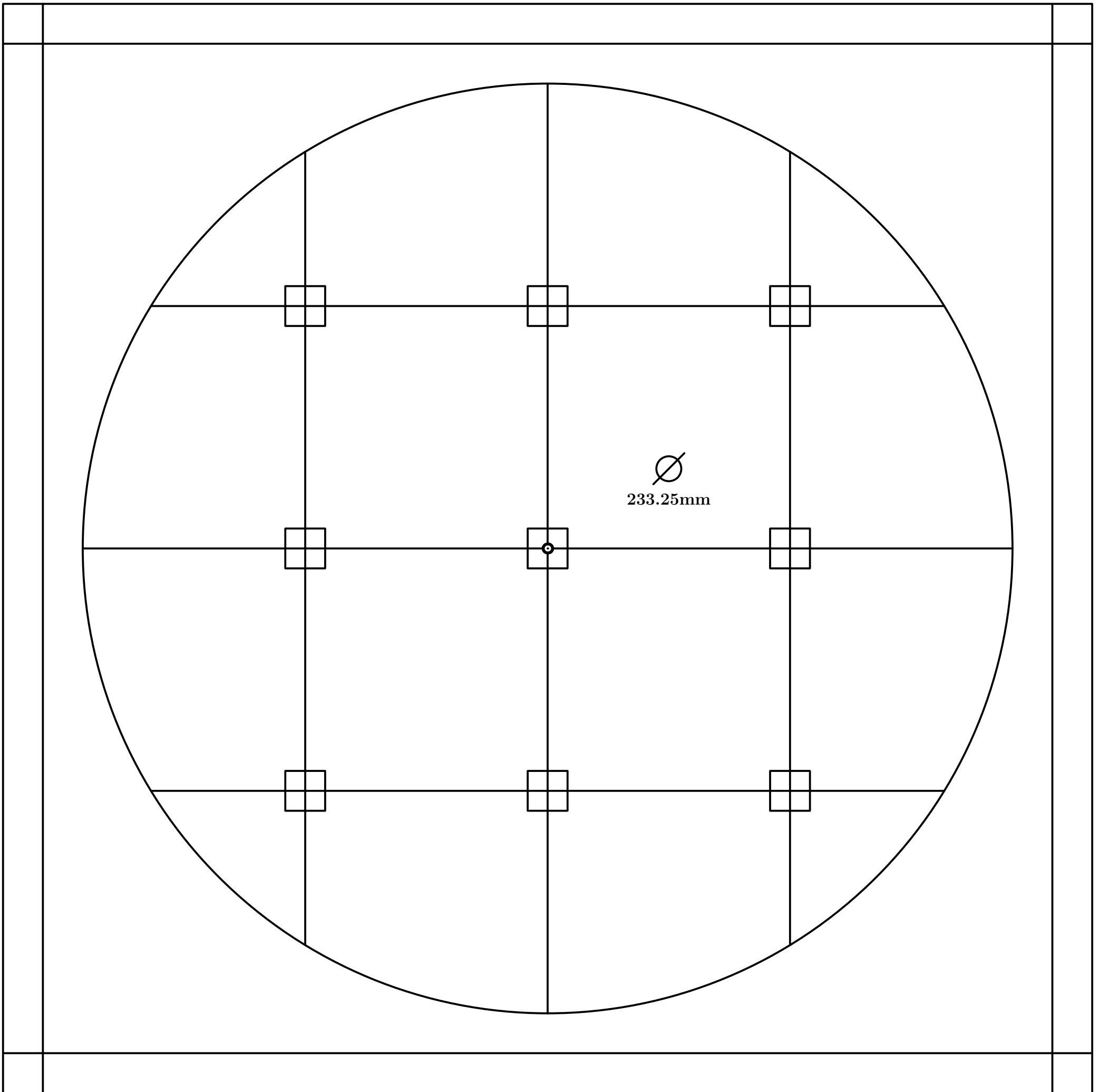

Fig. 534

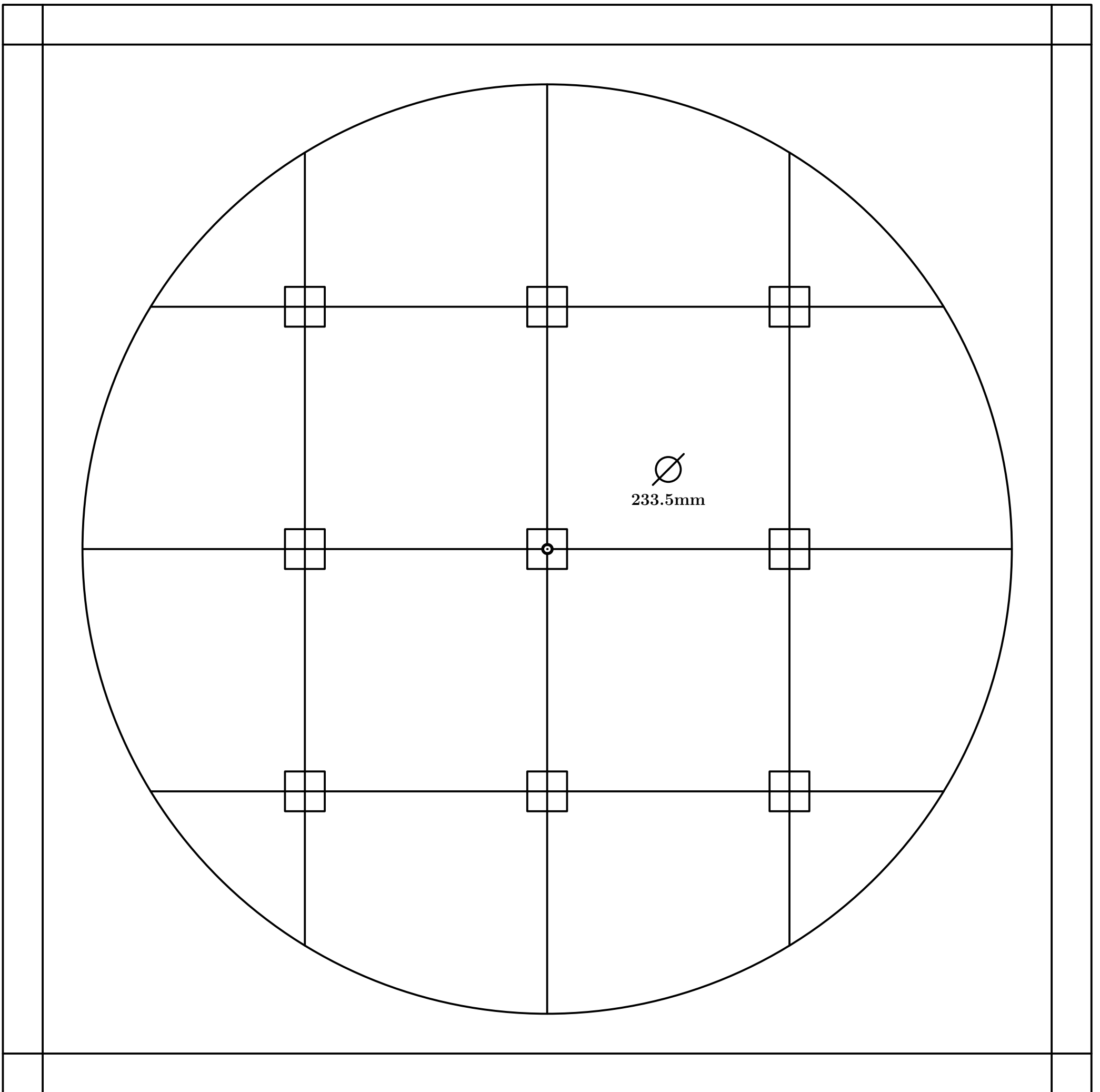

Fig. 535

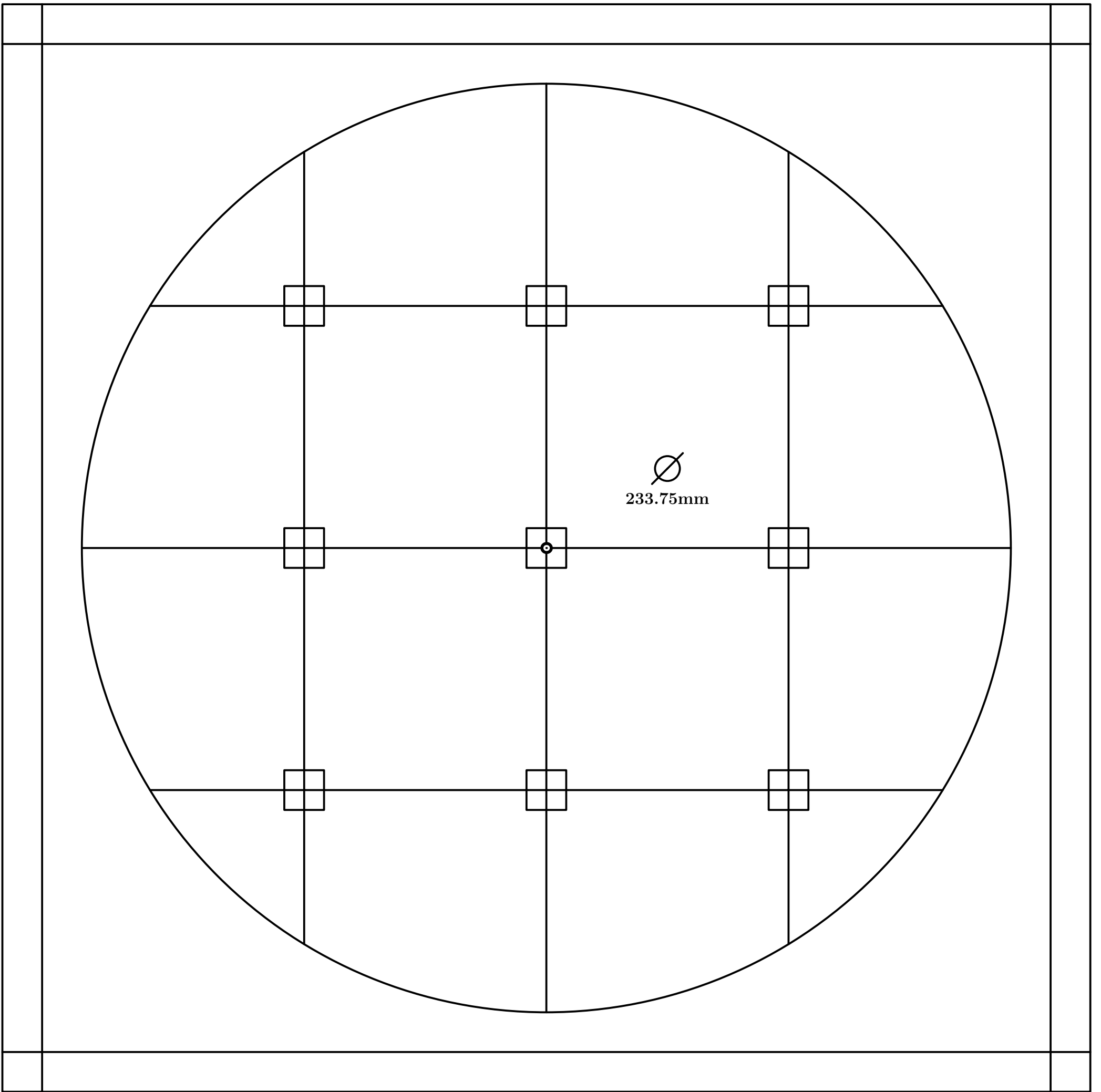

Fig. 536

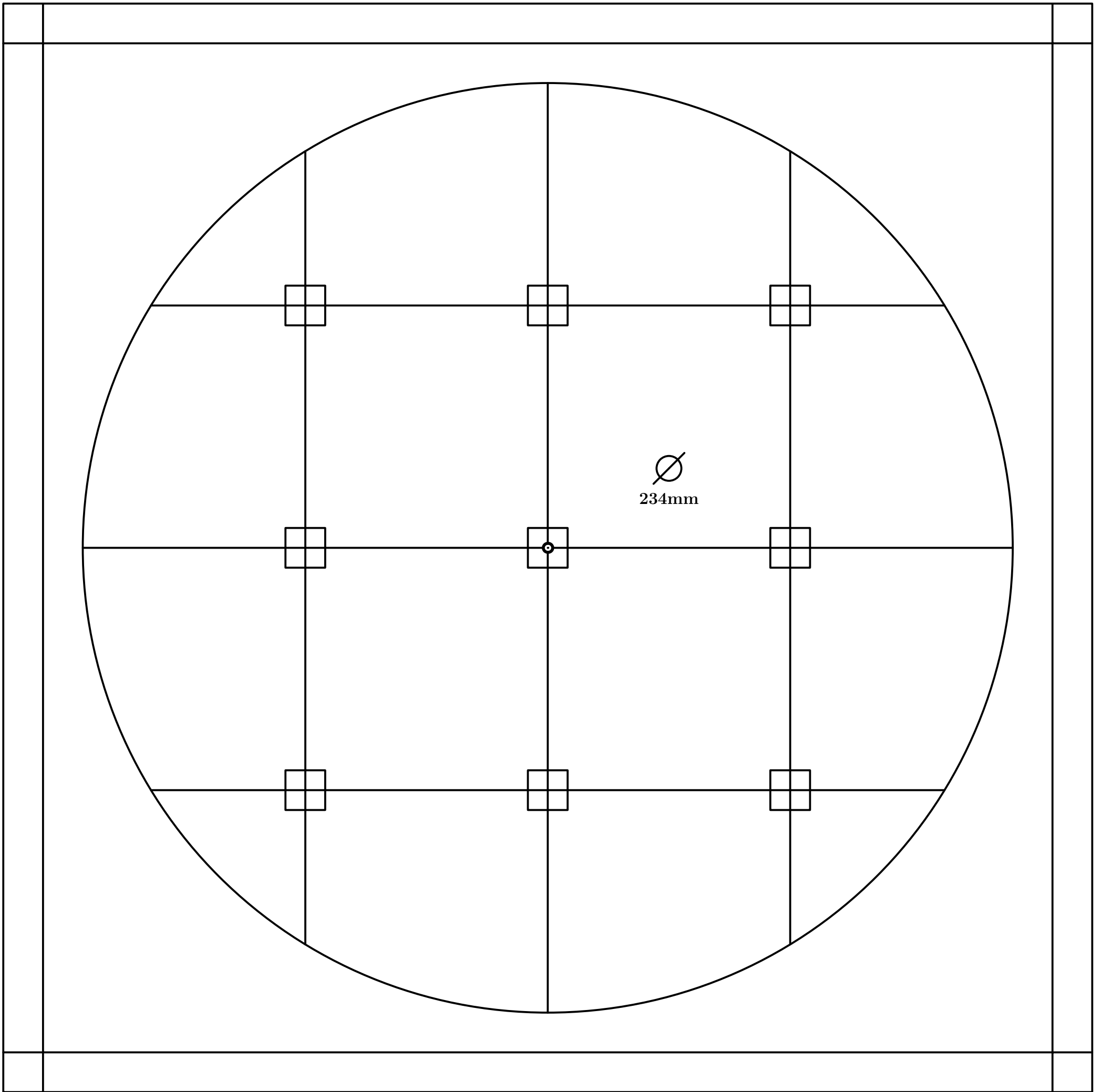

Fig. 537

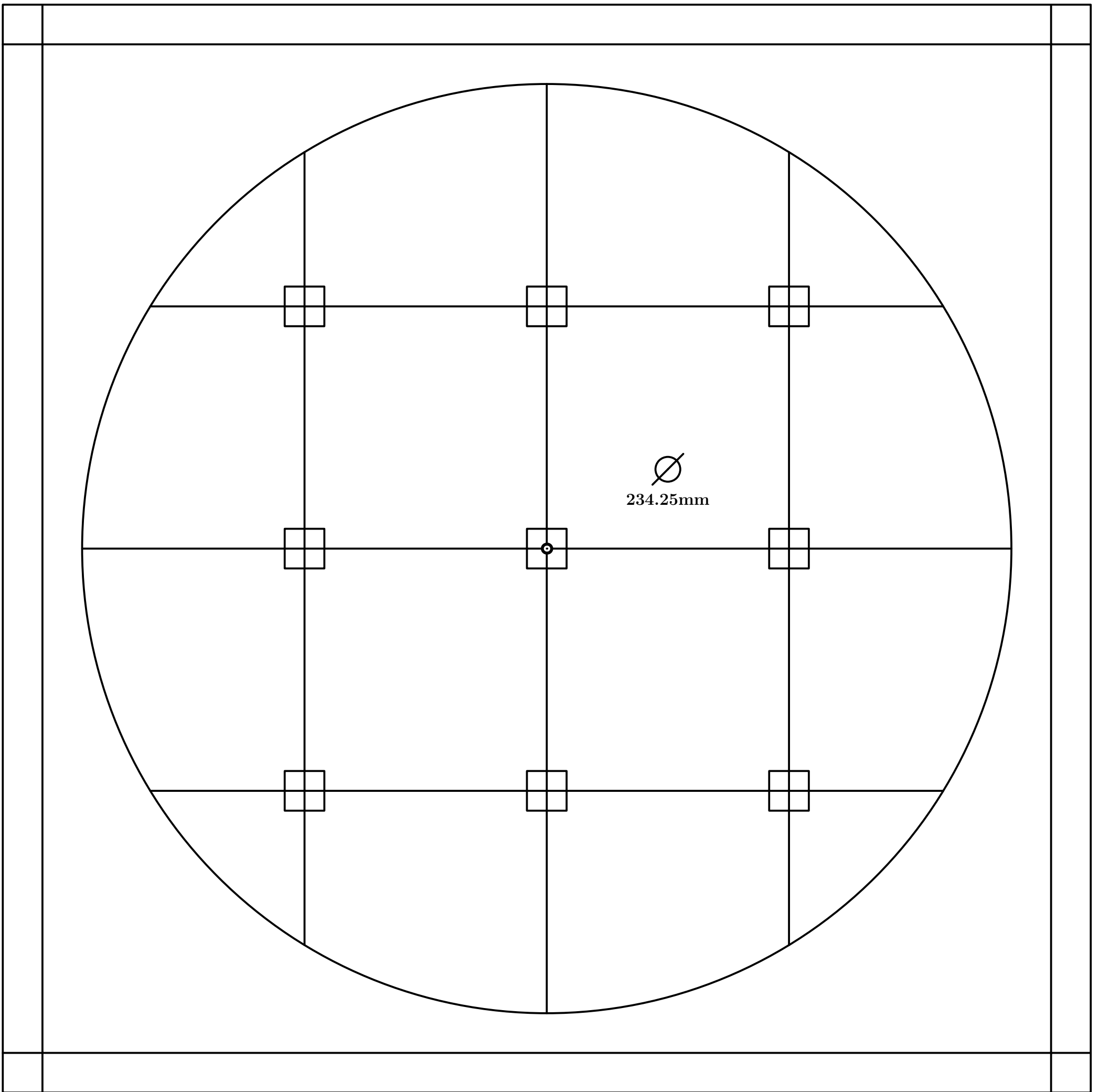

Fig. 538

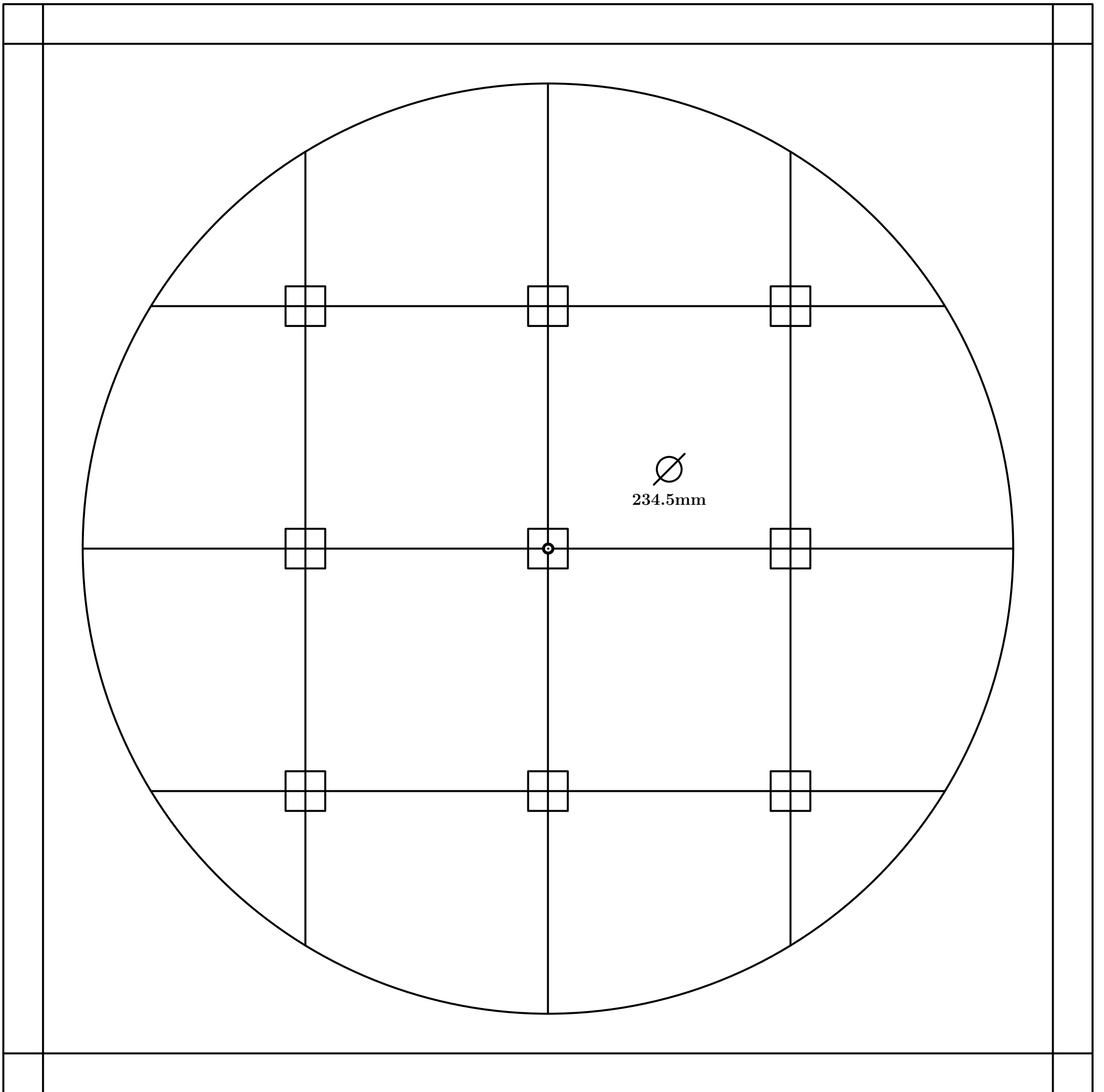

Fig. 539

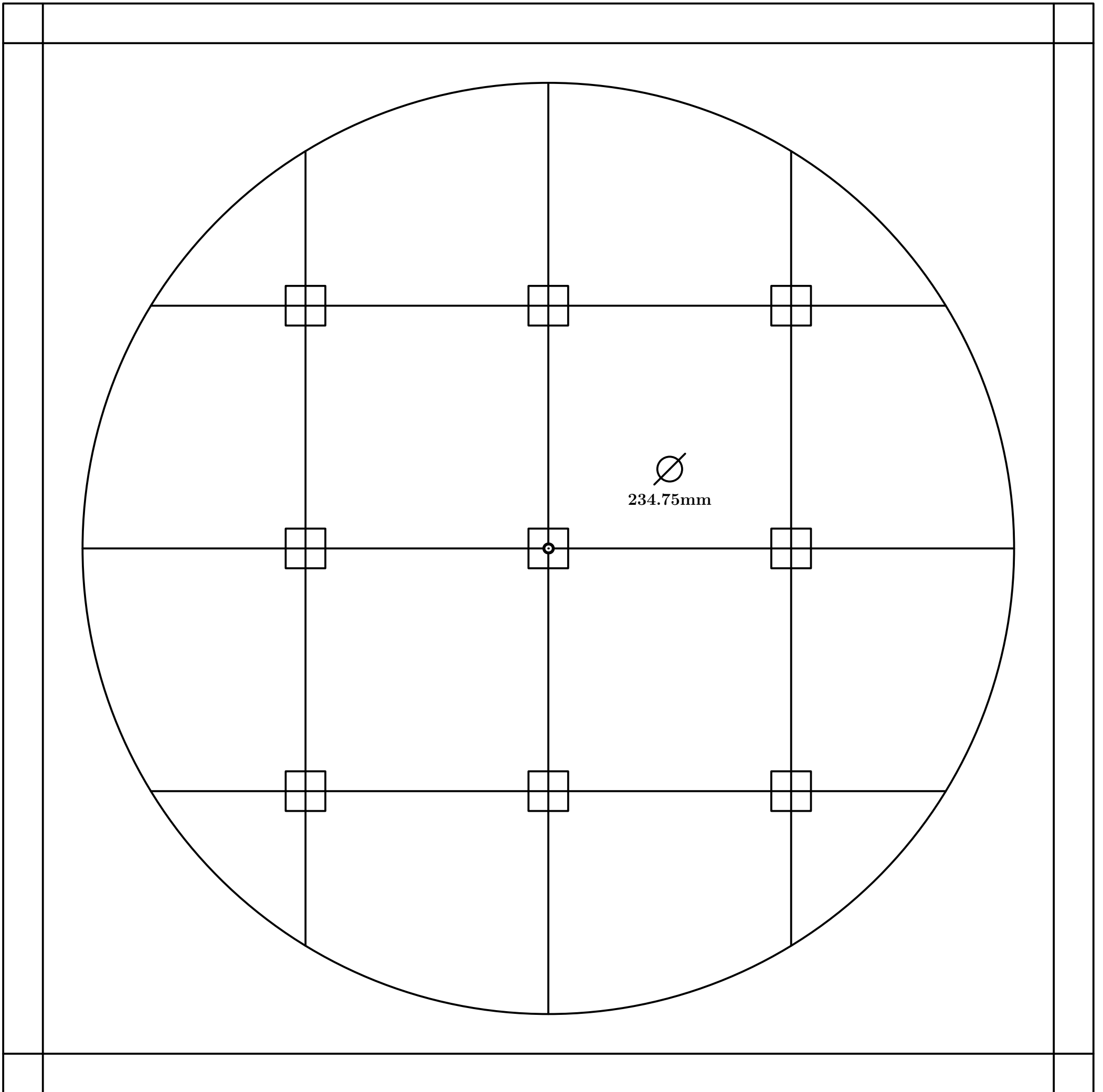

Fig. 540

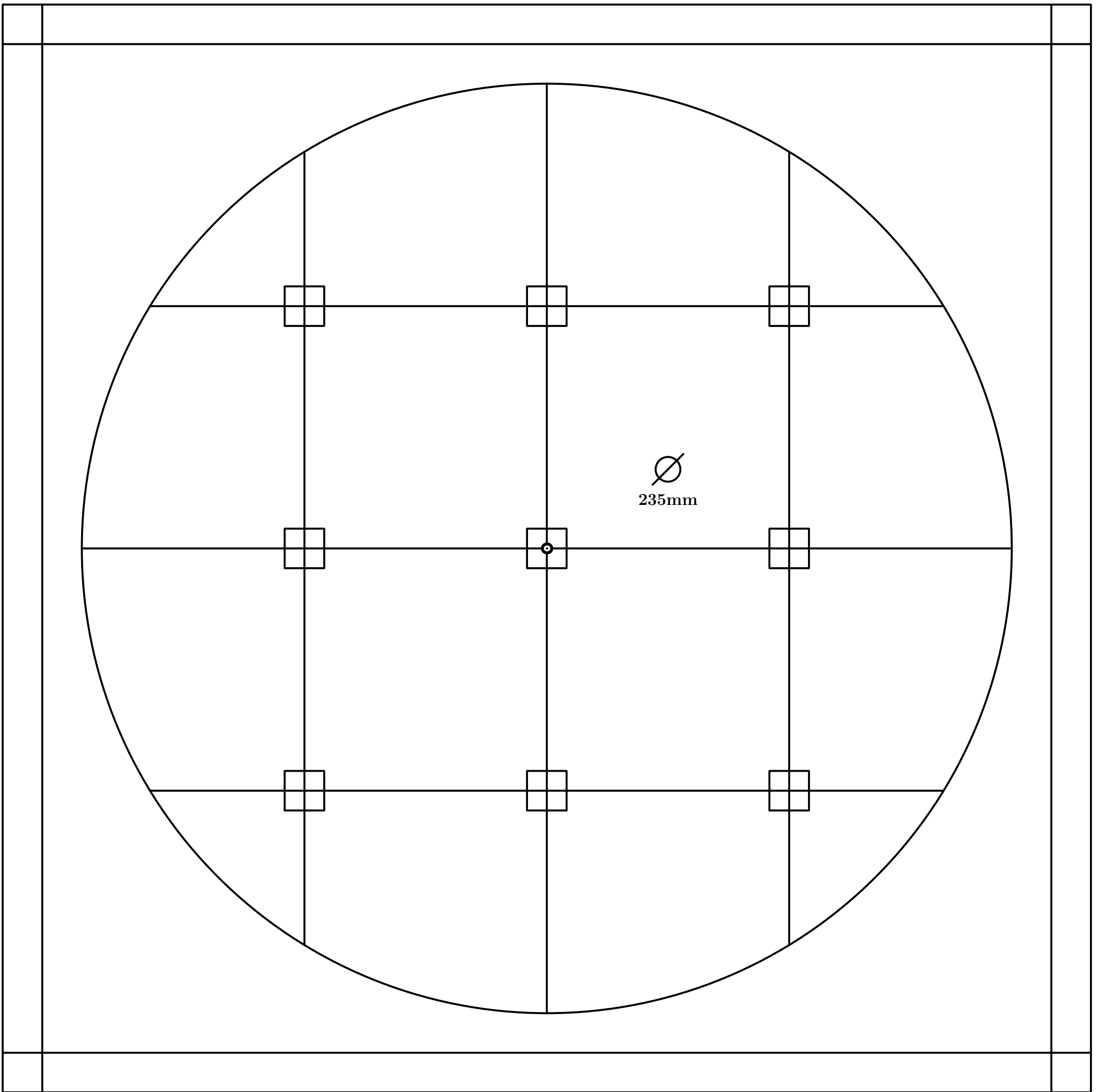

Fig. 541

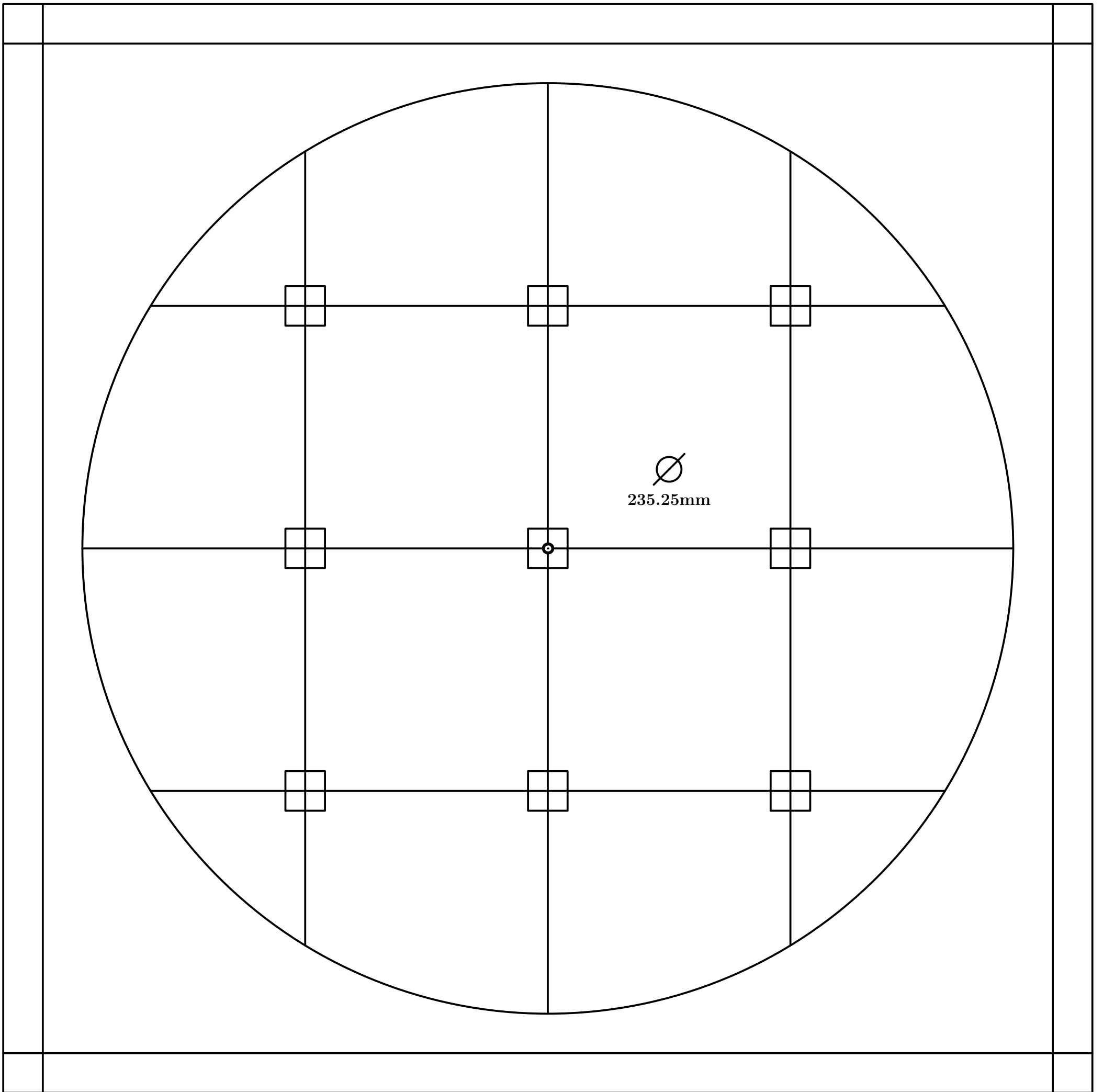

Fig. 542

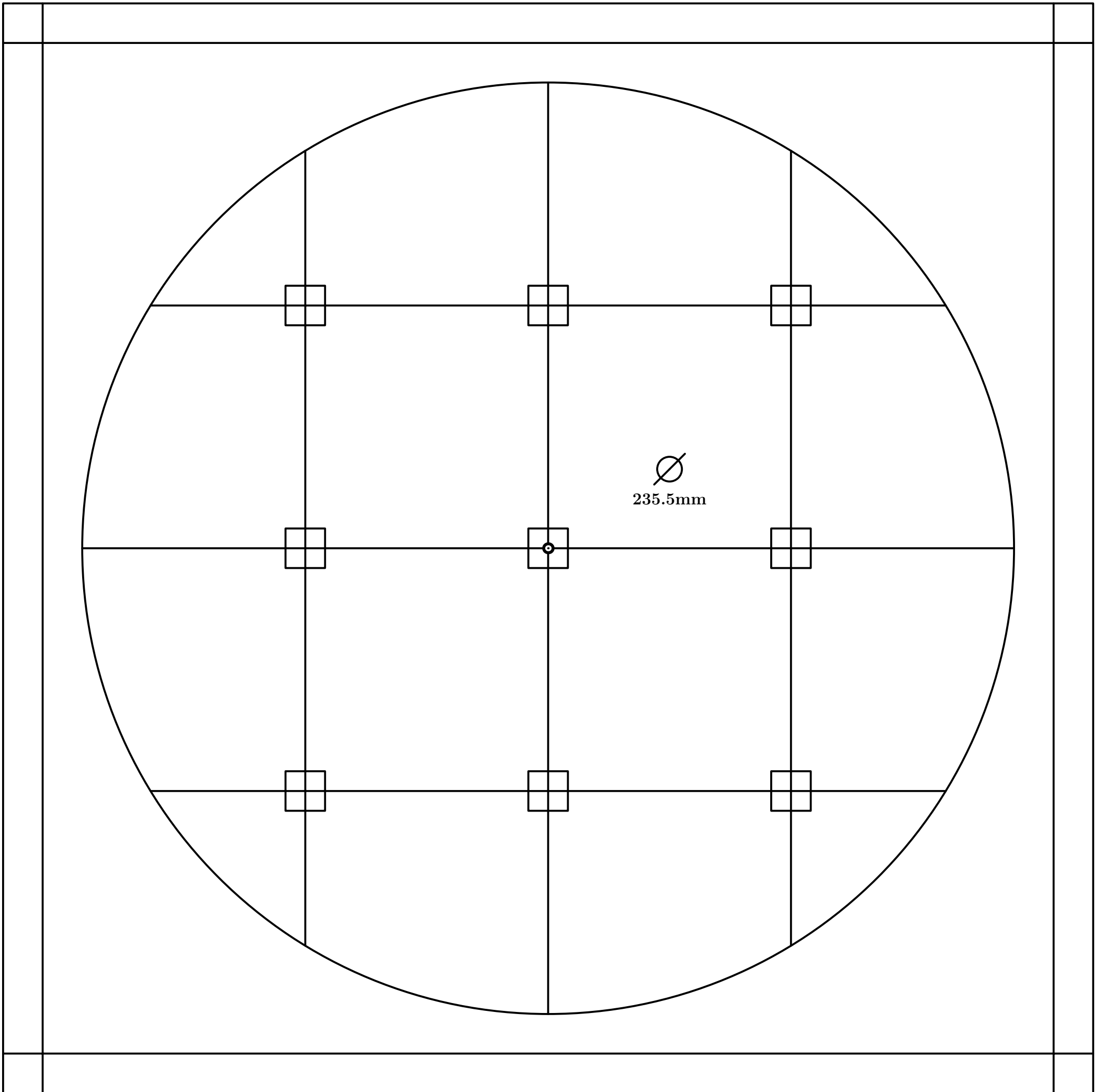

Fig. 543

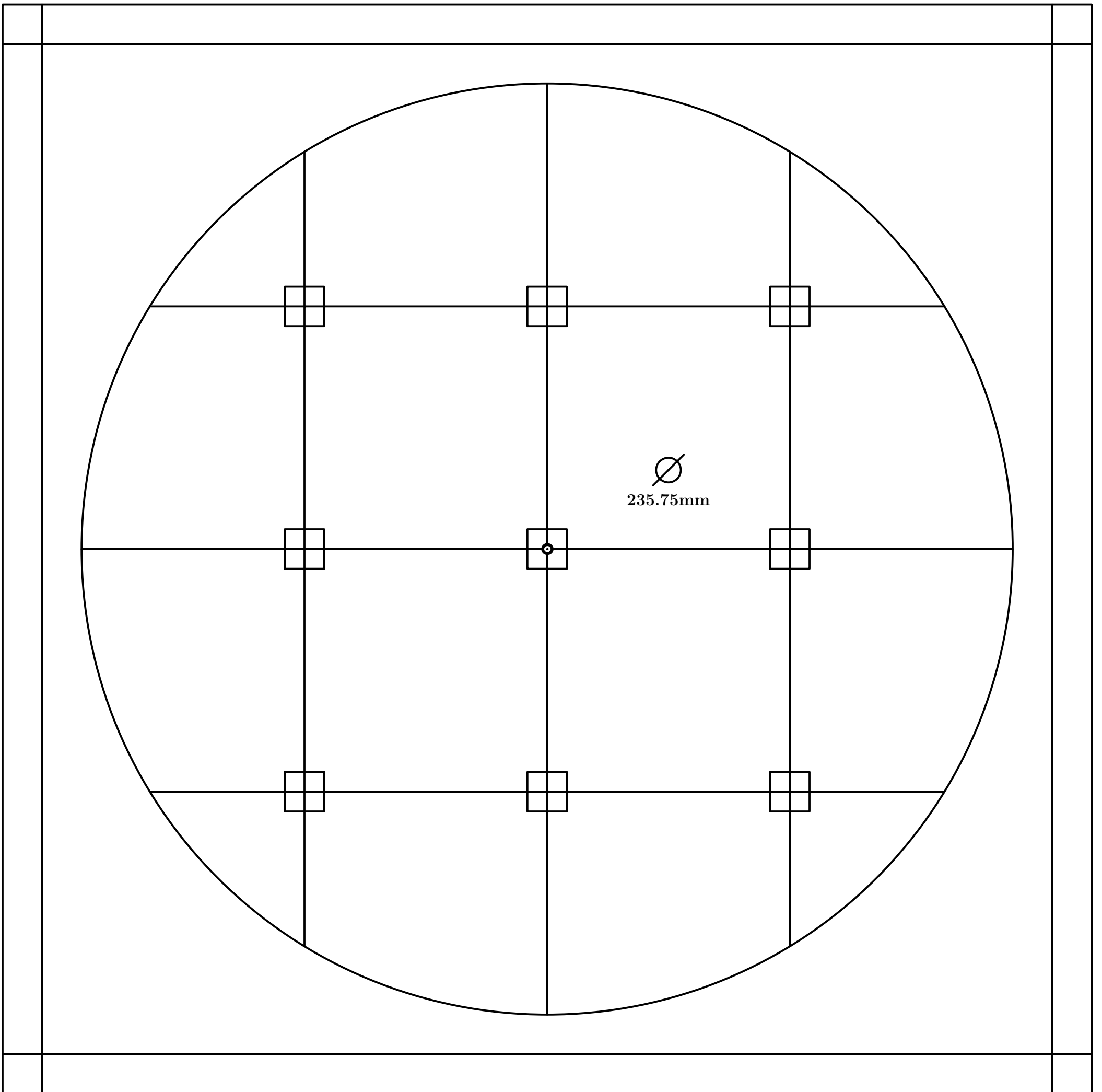

Fig. 544

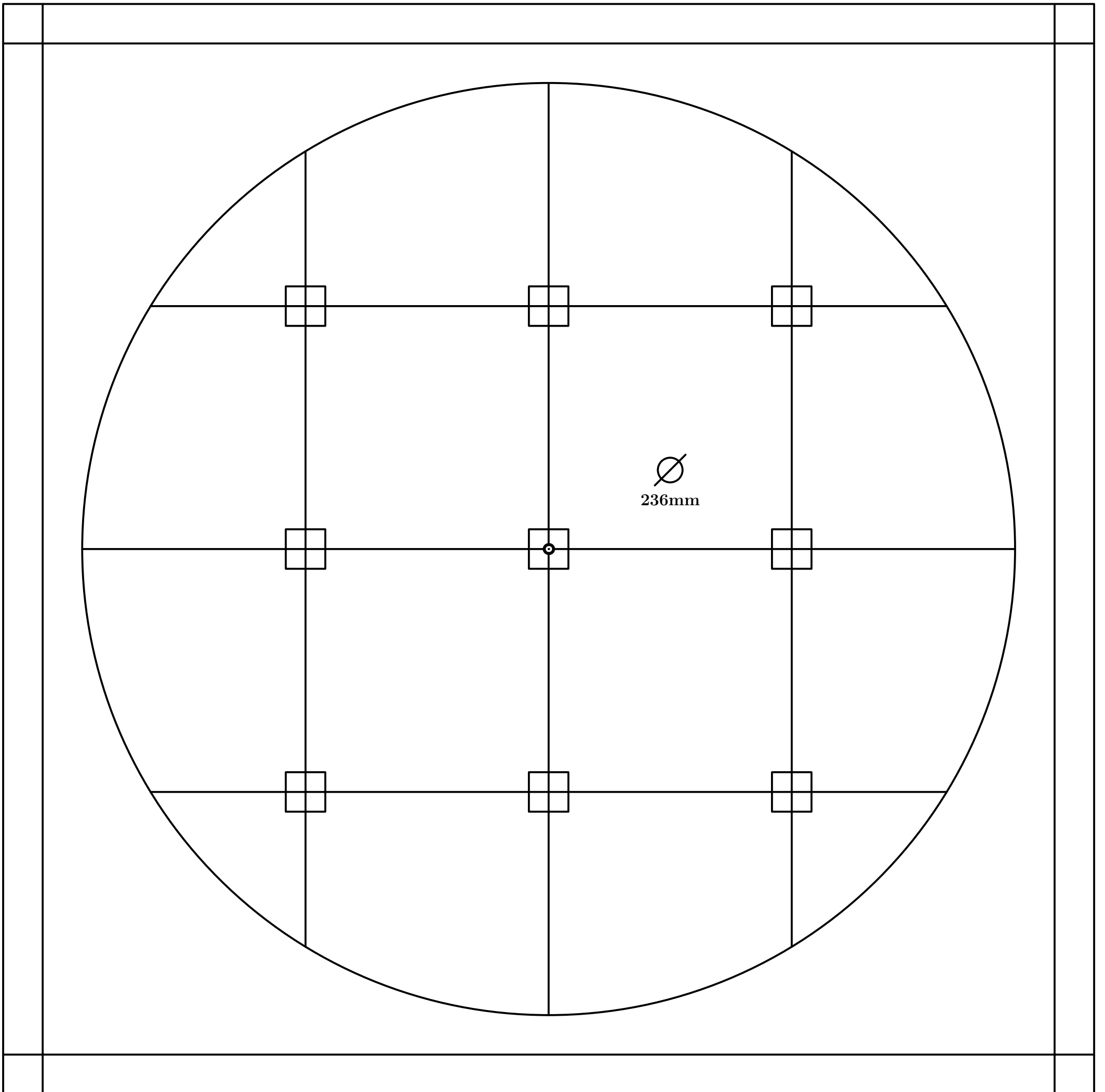

Fig. 545

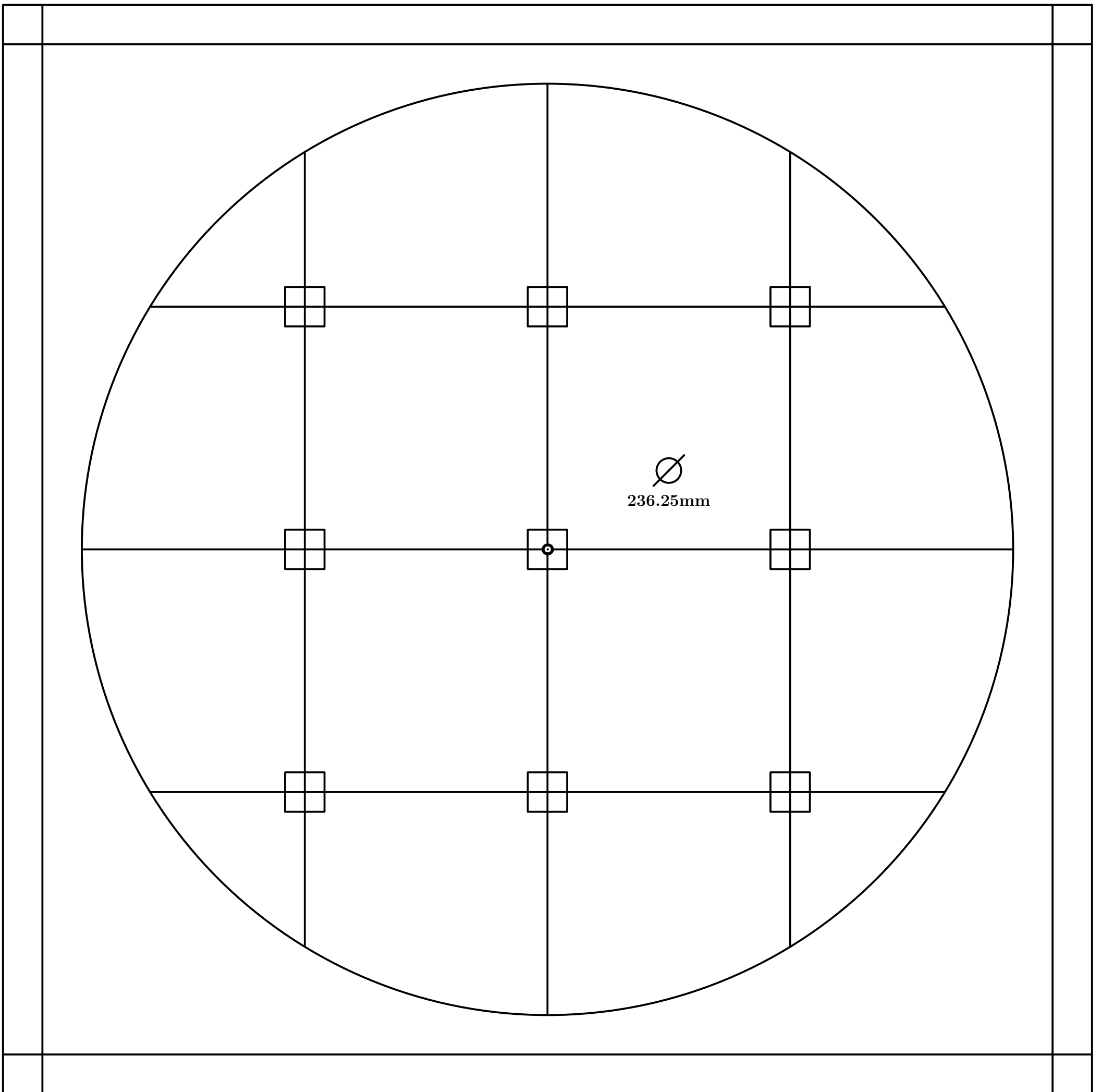

Fig. 546

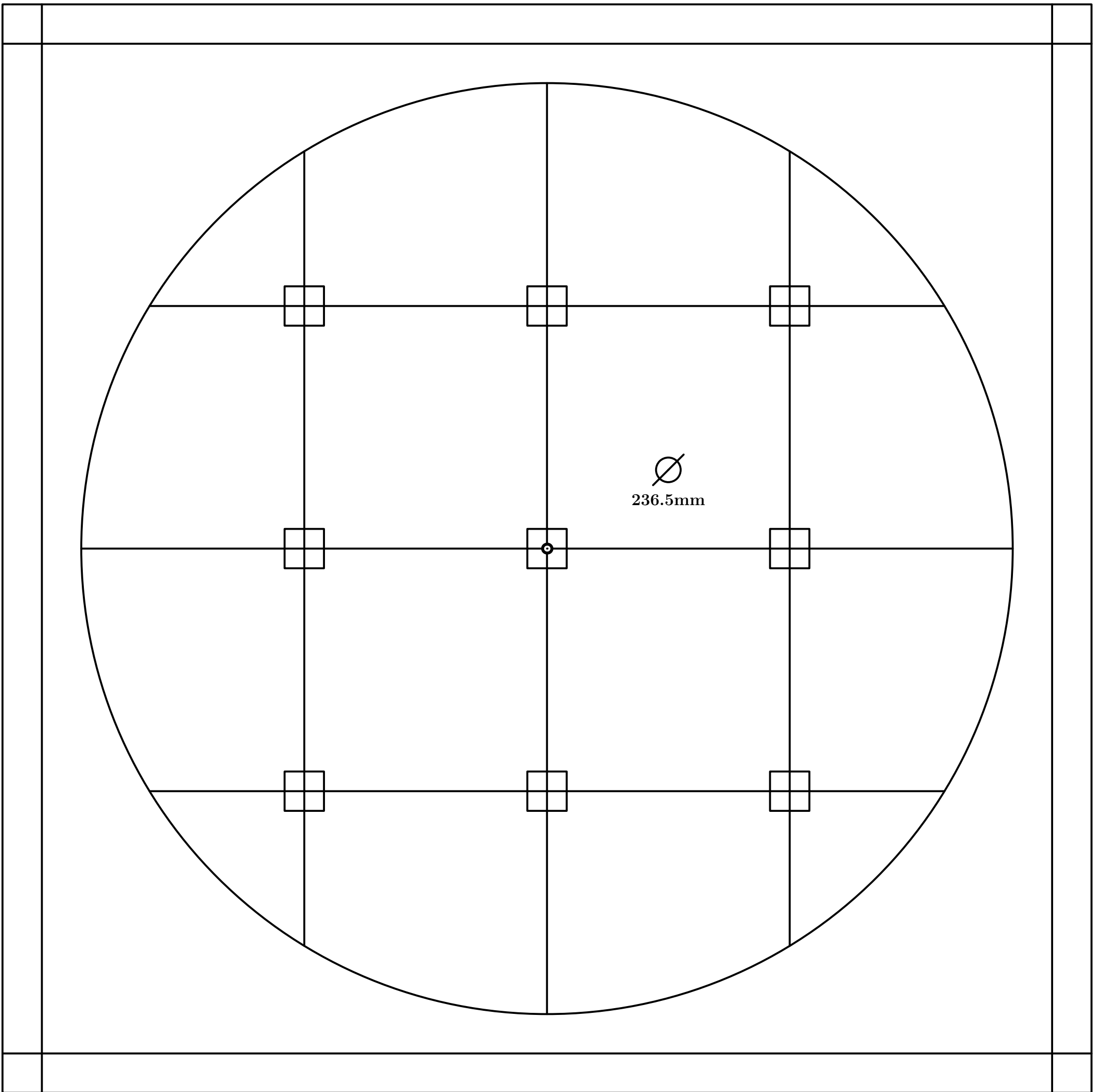

Fig. 547

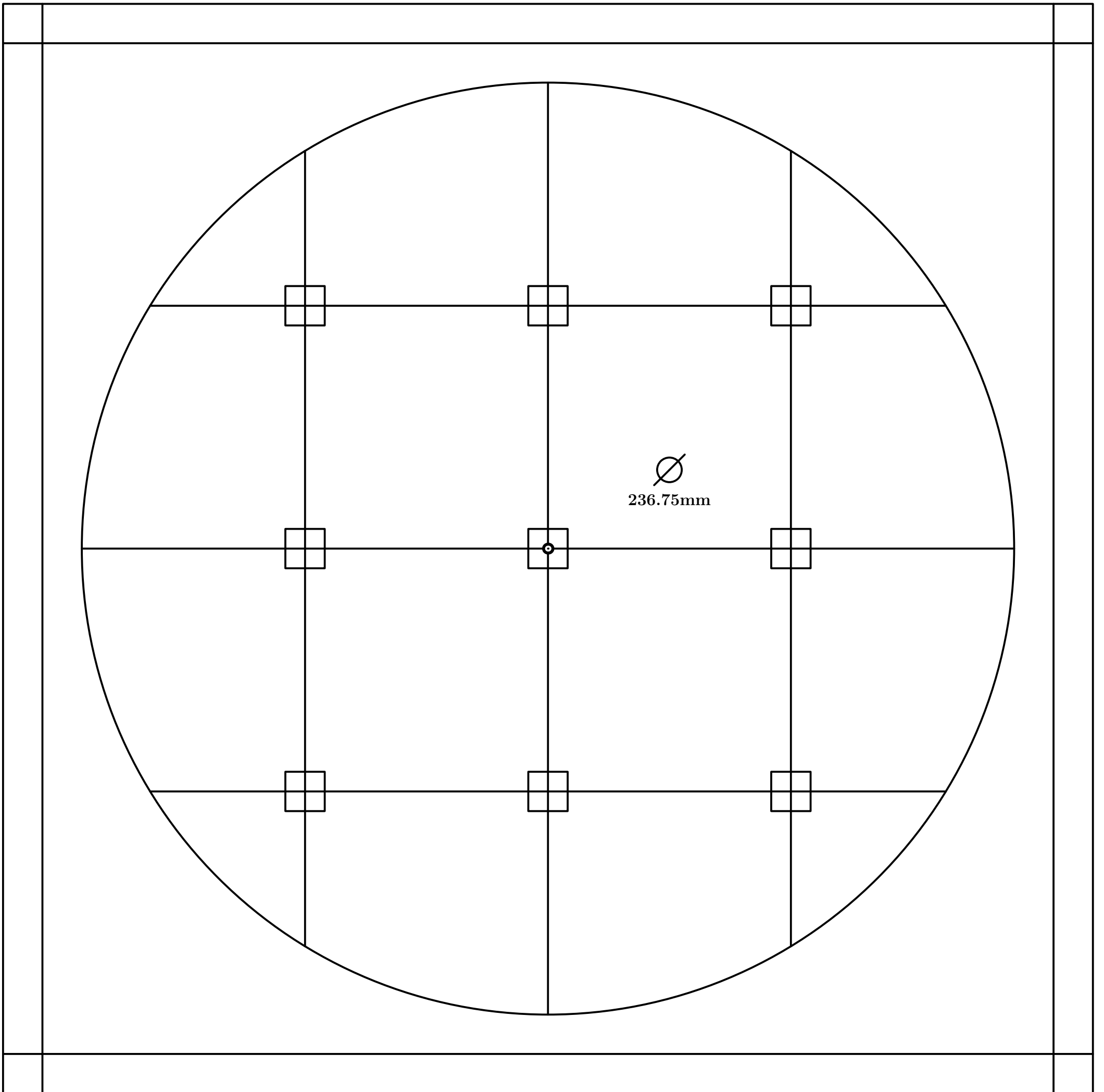

Fig. 548

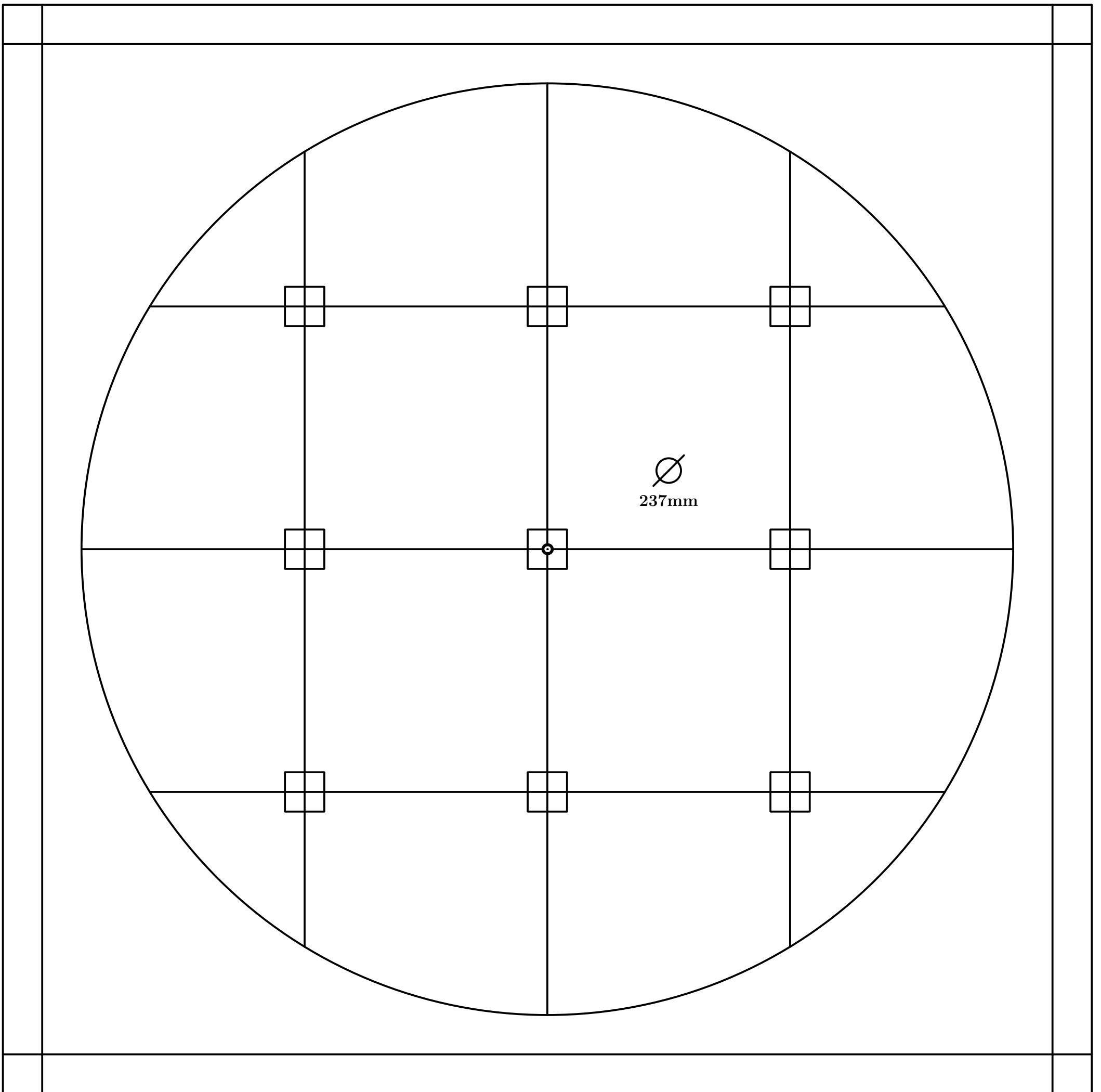

Fig. 549

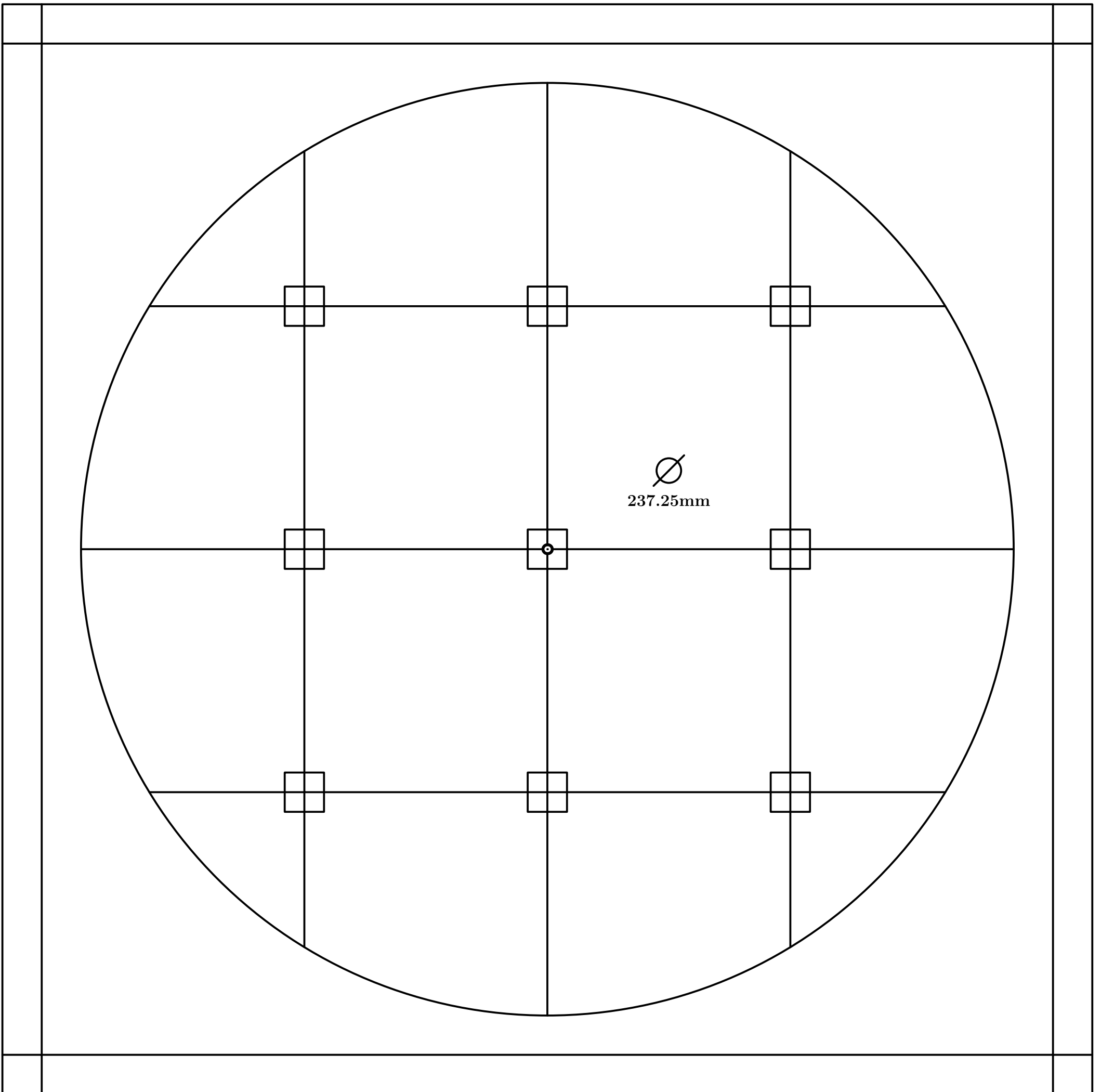

Fig. 550

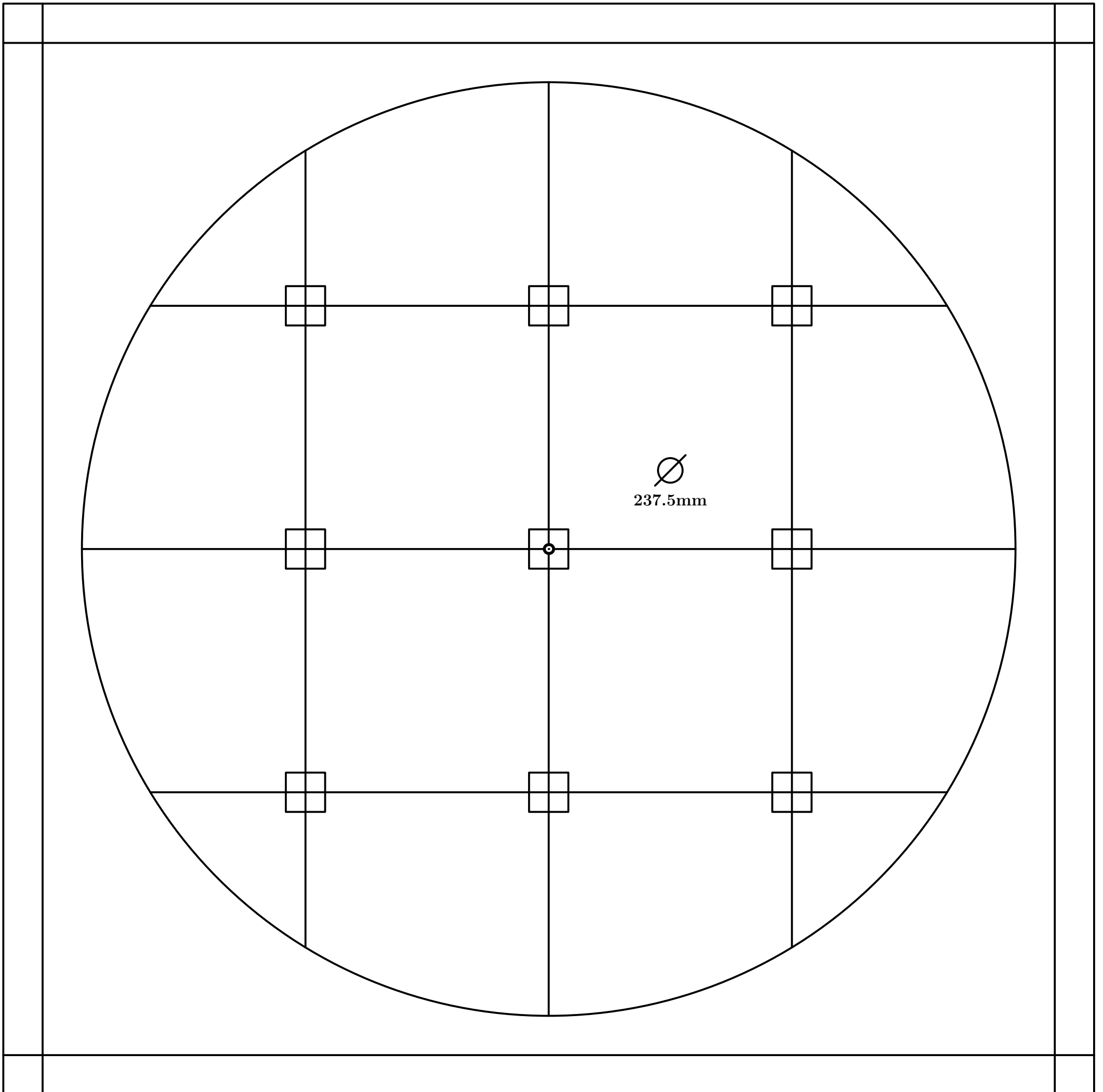

Fig. 551

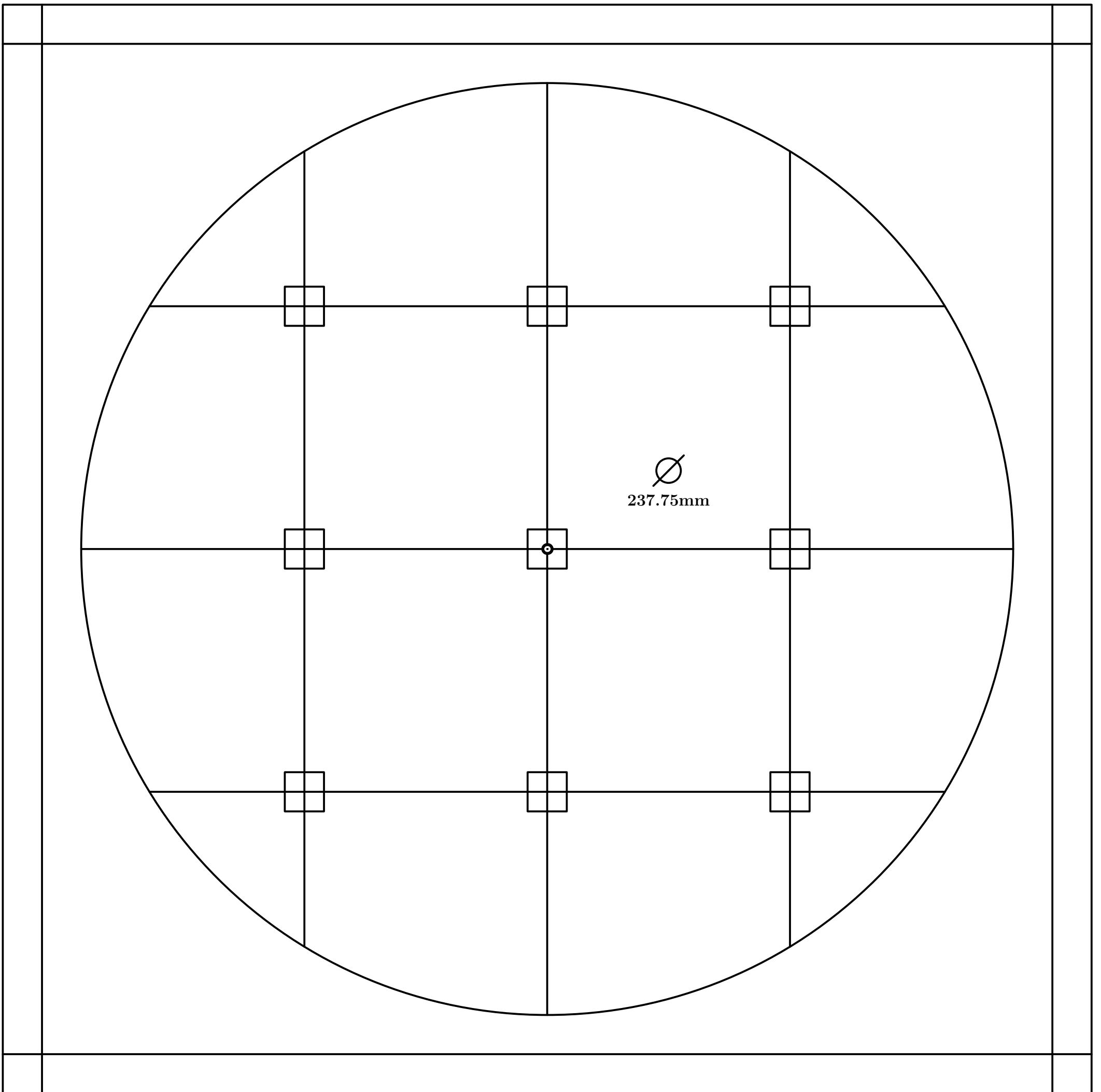

Fig. 552

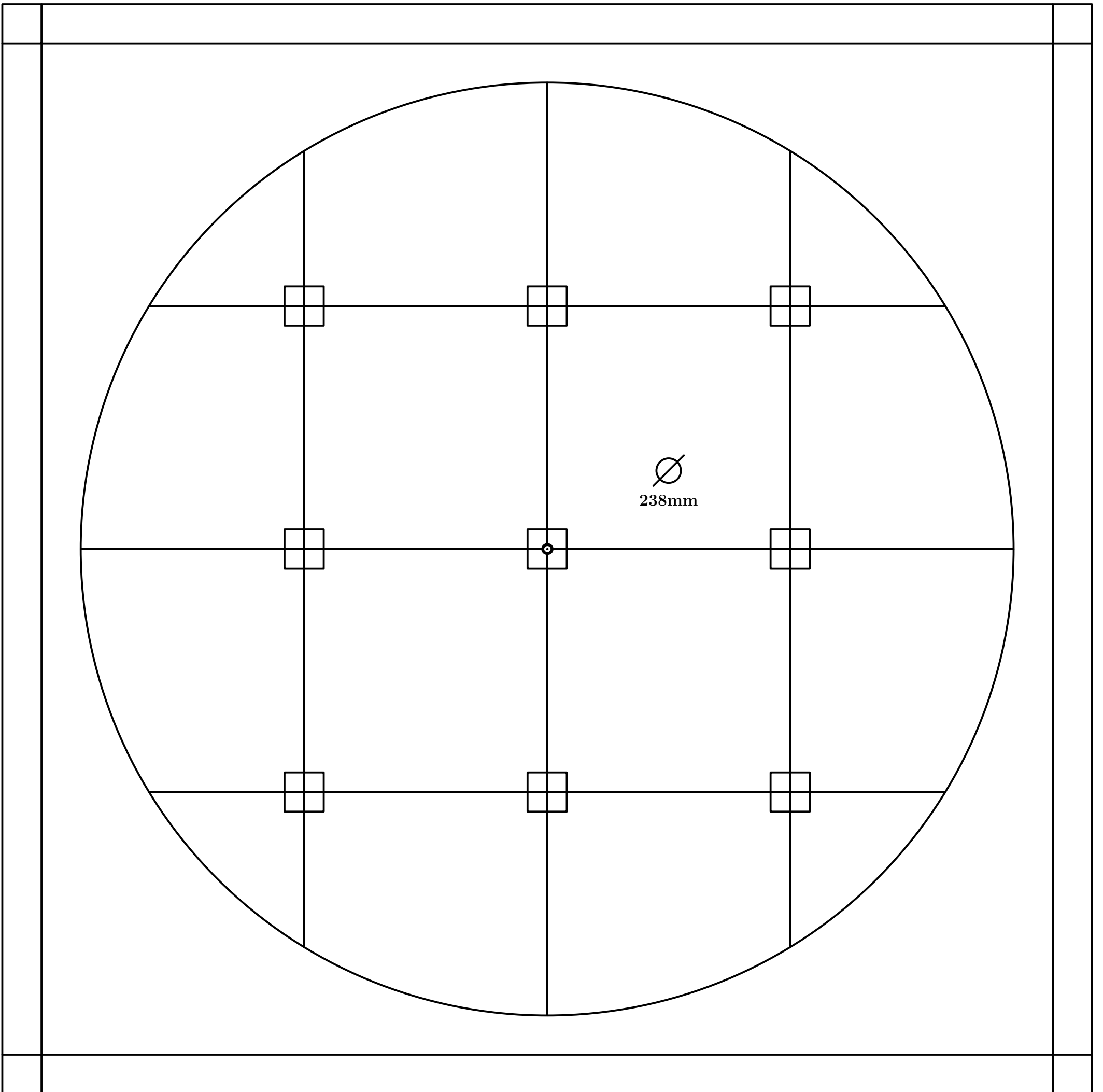

Fig. 553

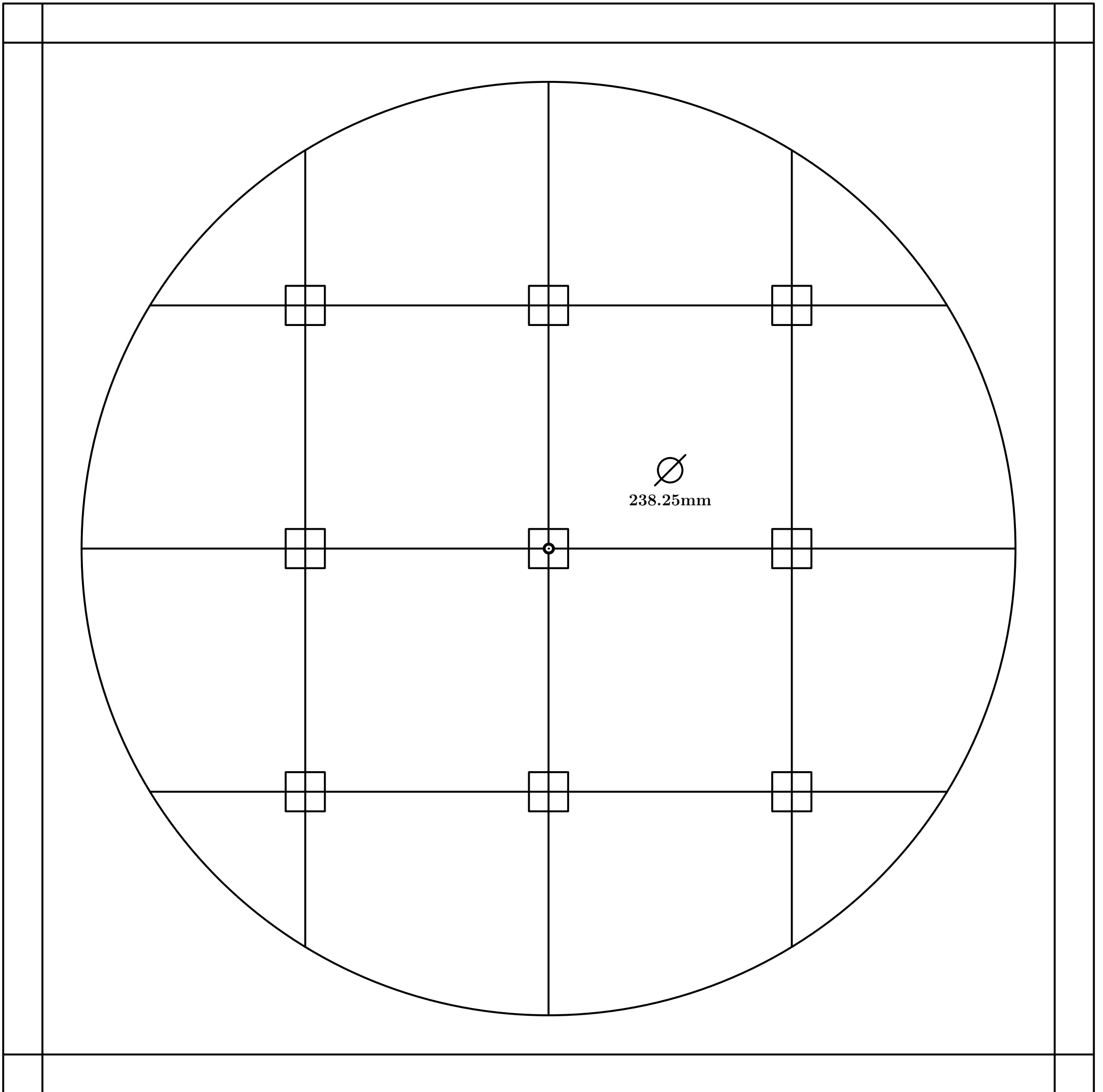

Fig. 554

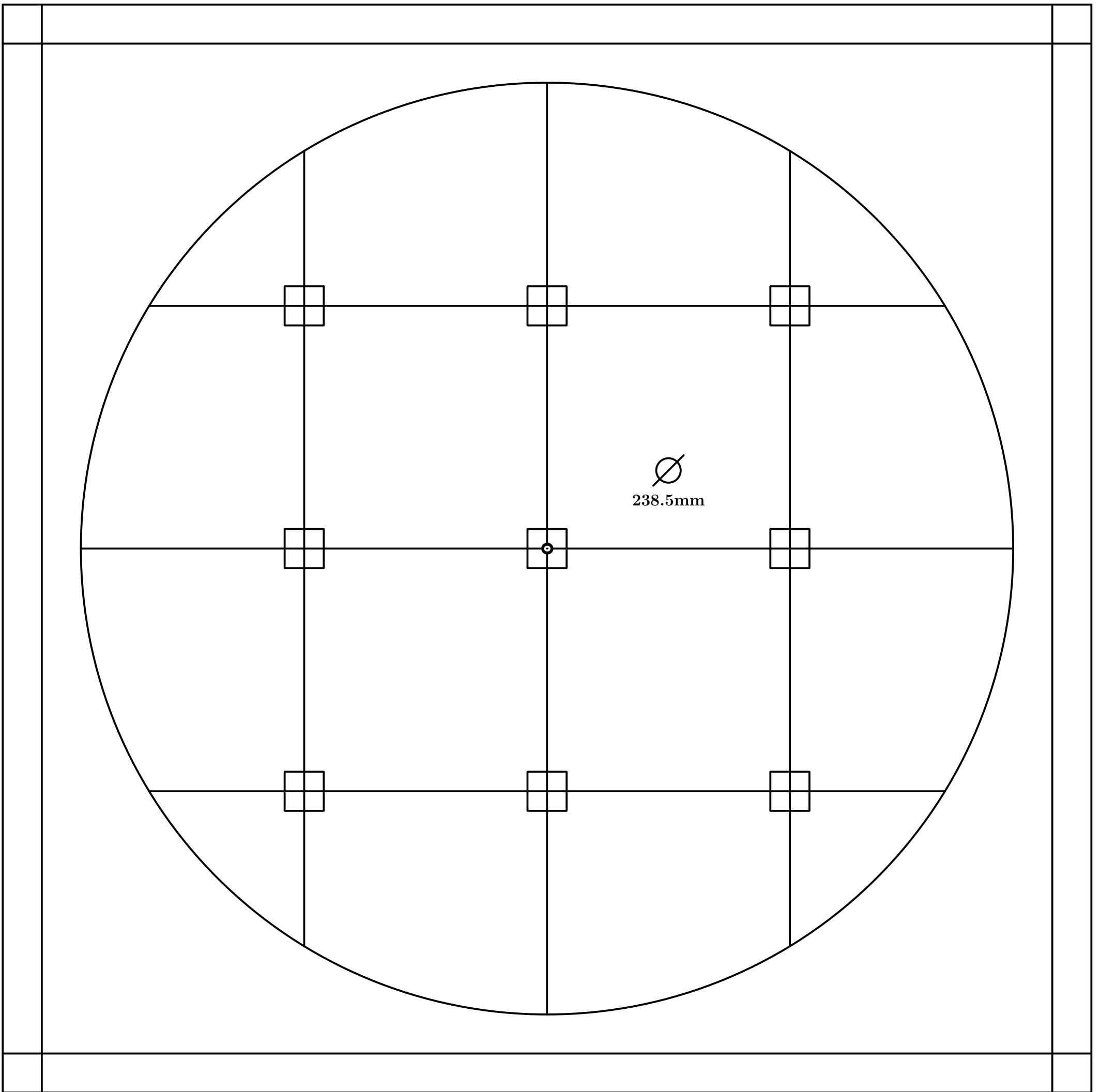

Fig. 555

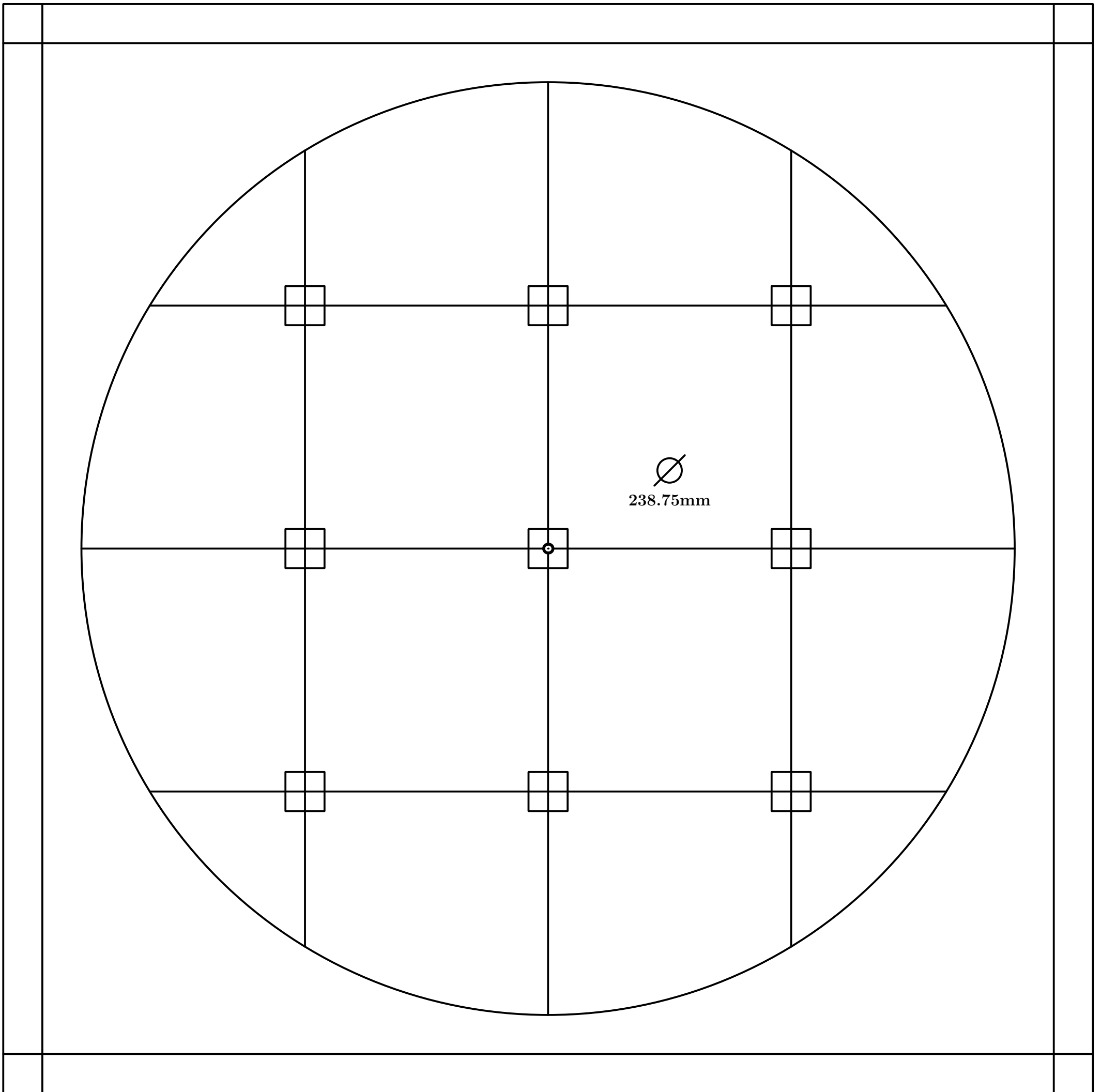

Fig. 556

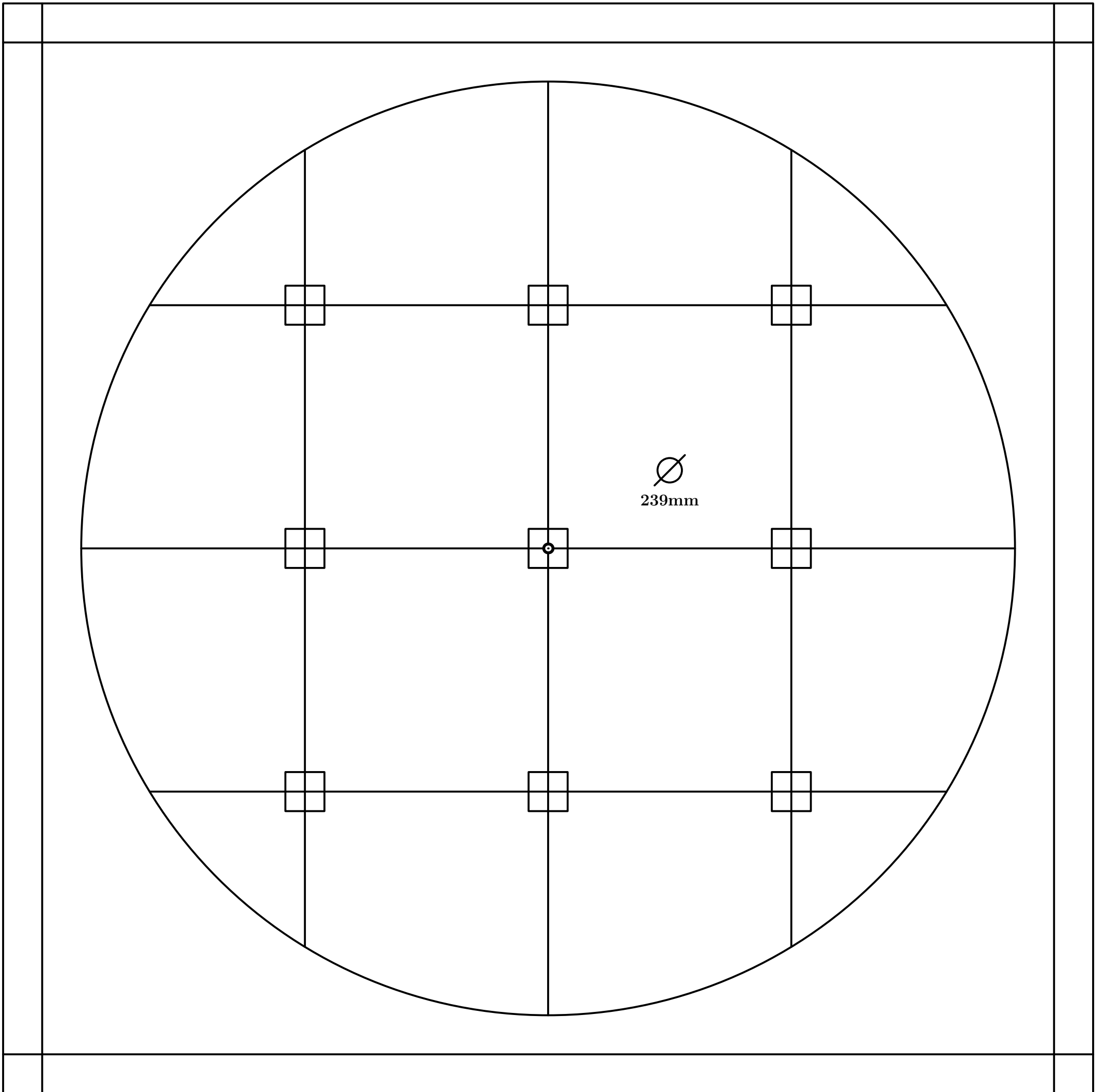

Fig. 557

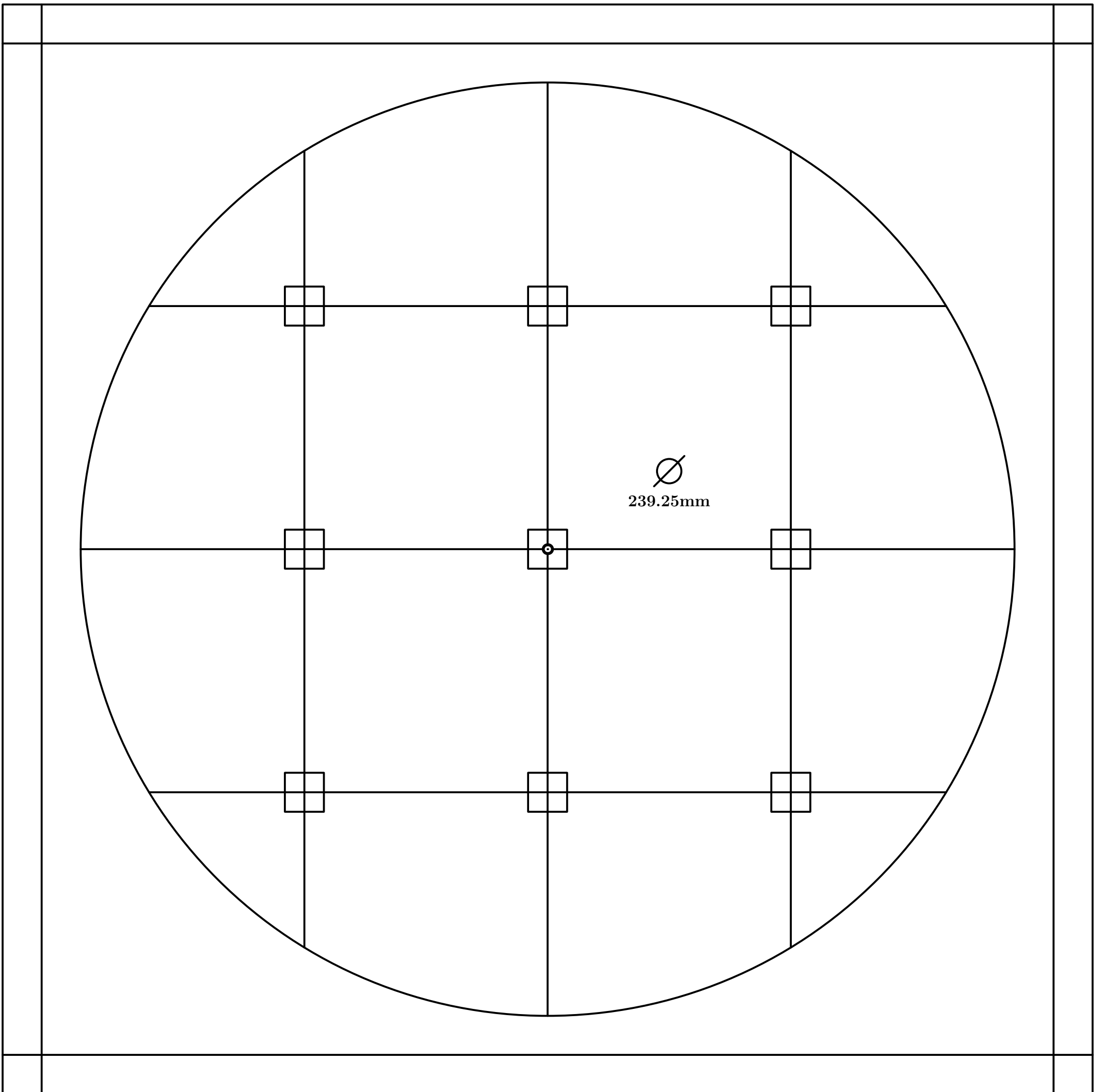

Fig. 558

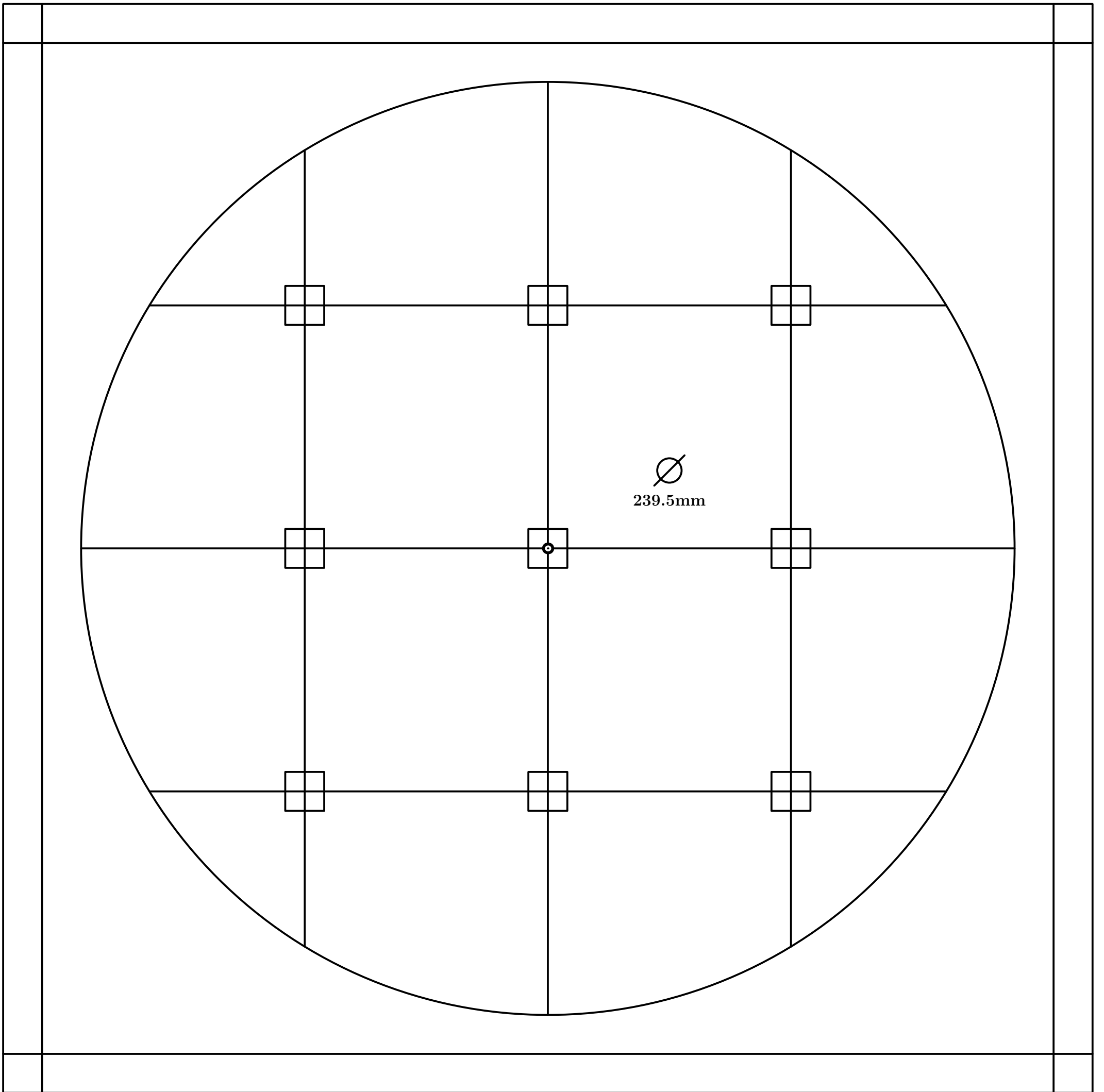

Fig. 559

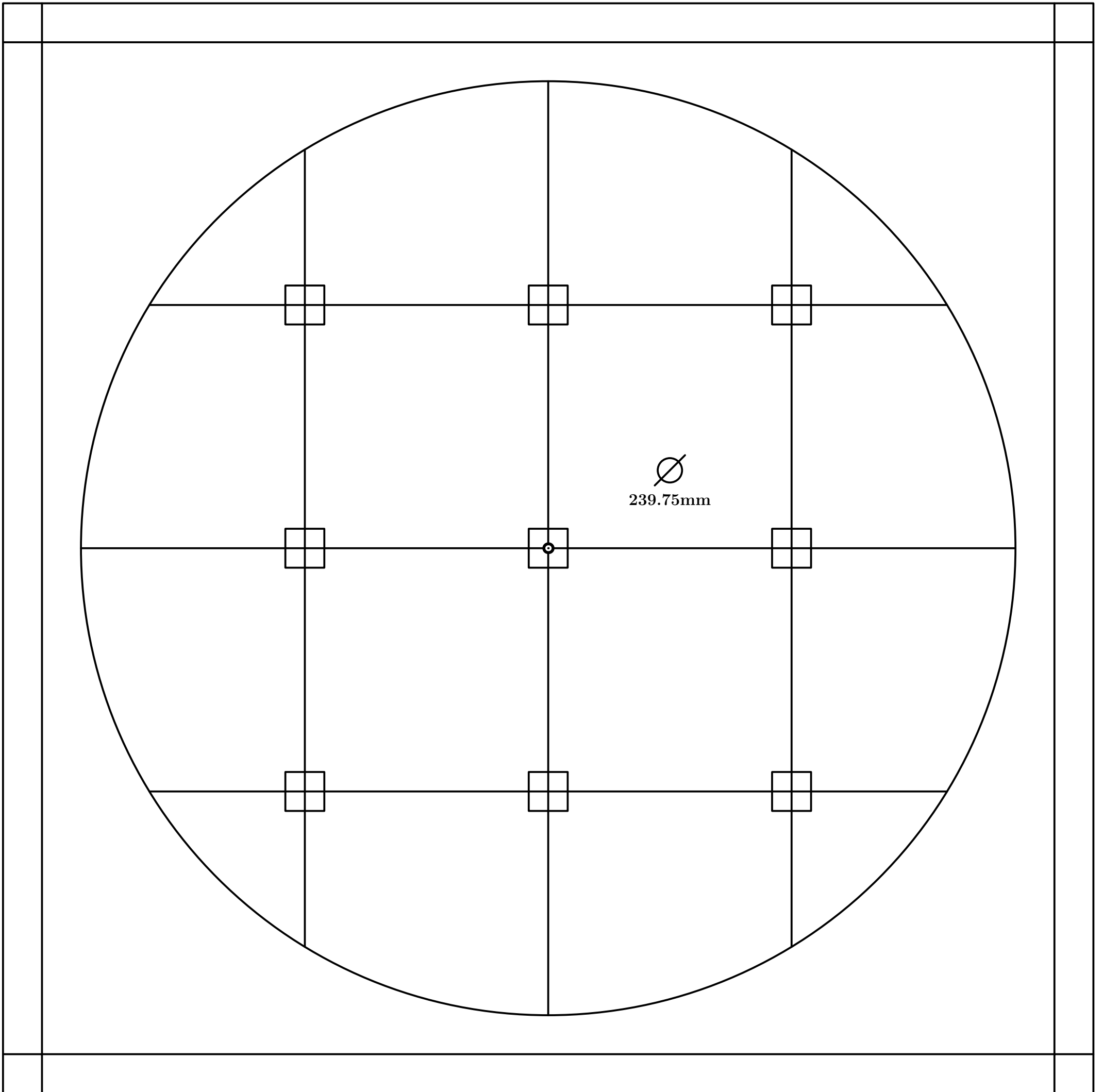

Fig. 560

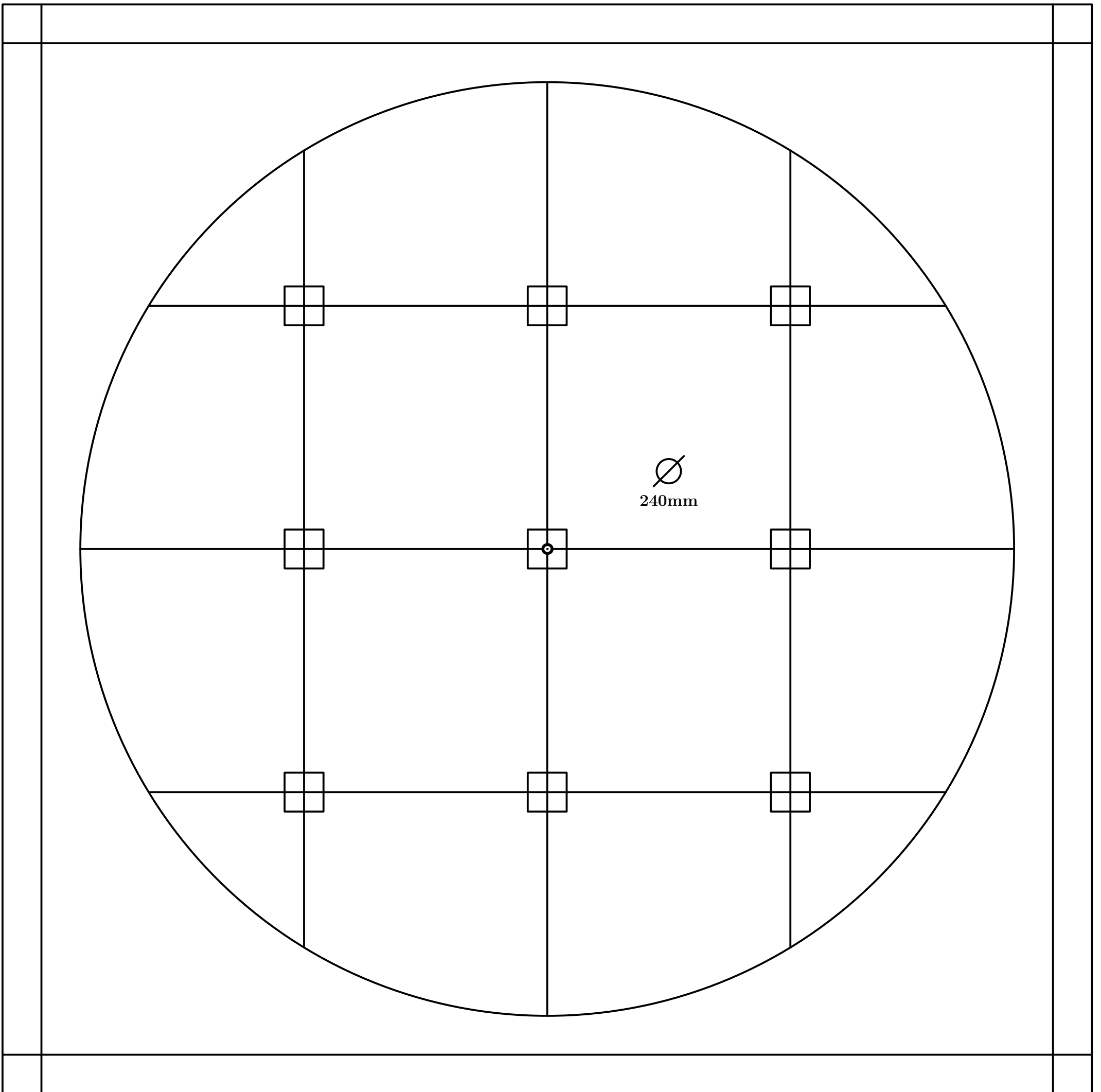

Fig. 561

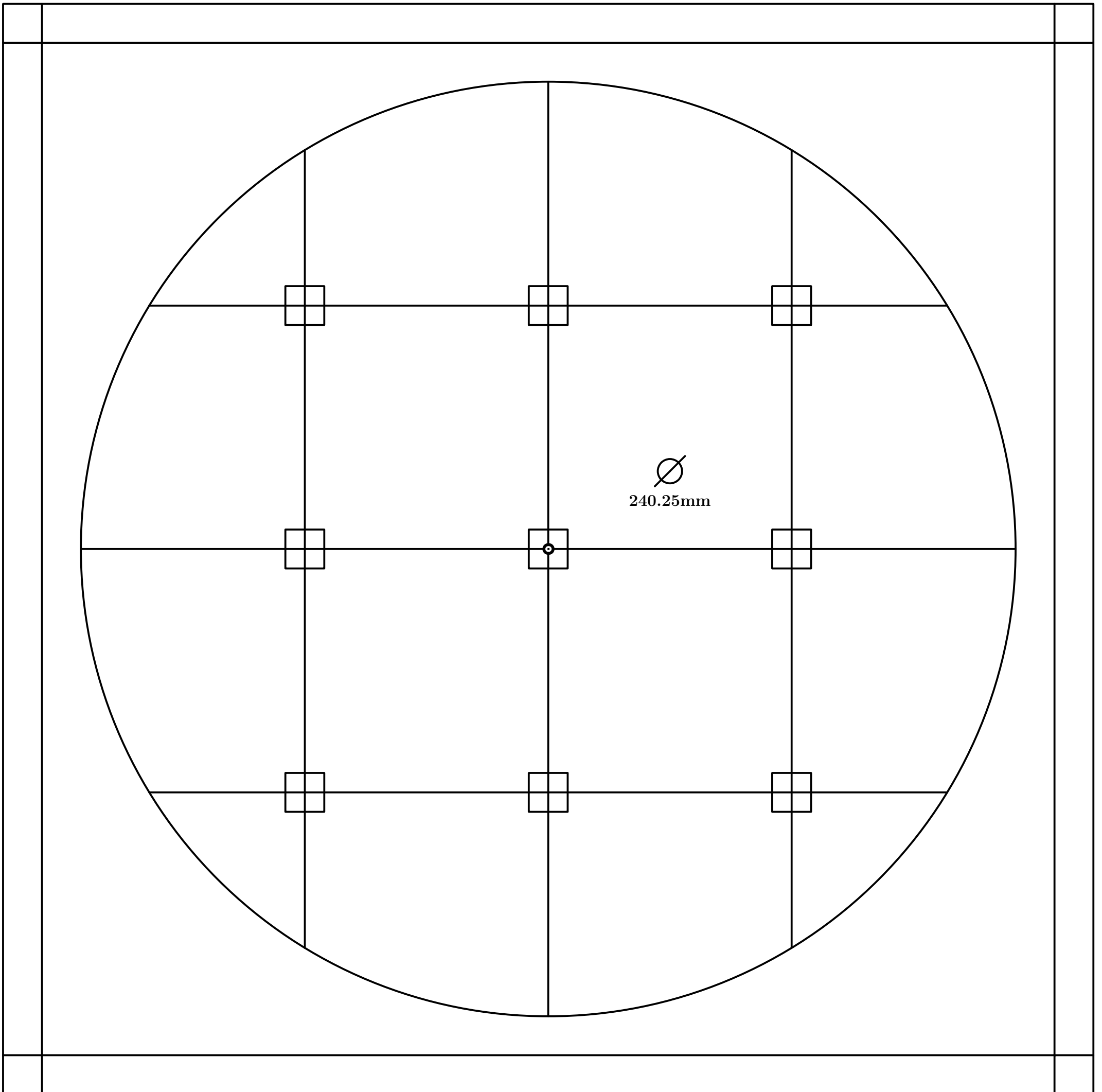

Fig. 562

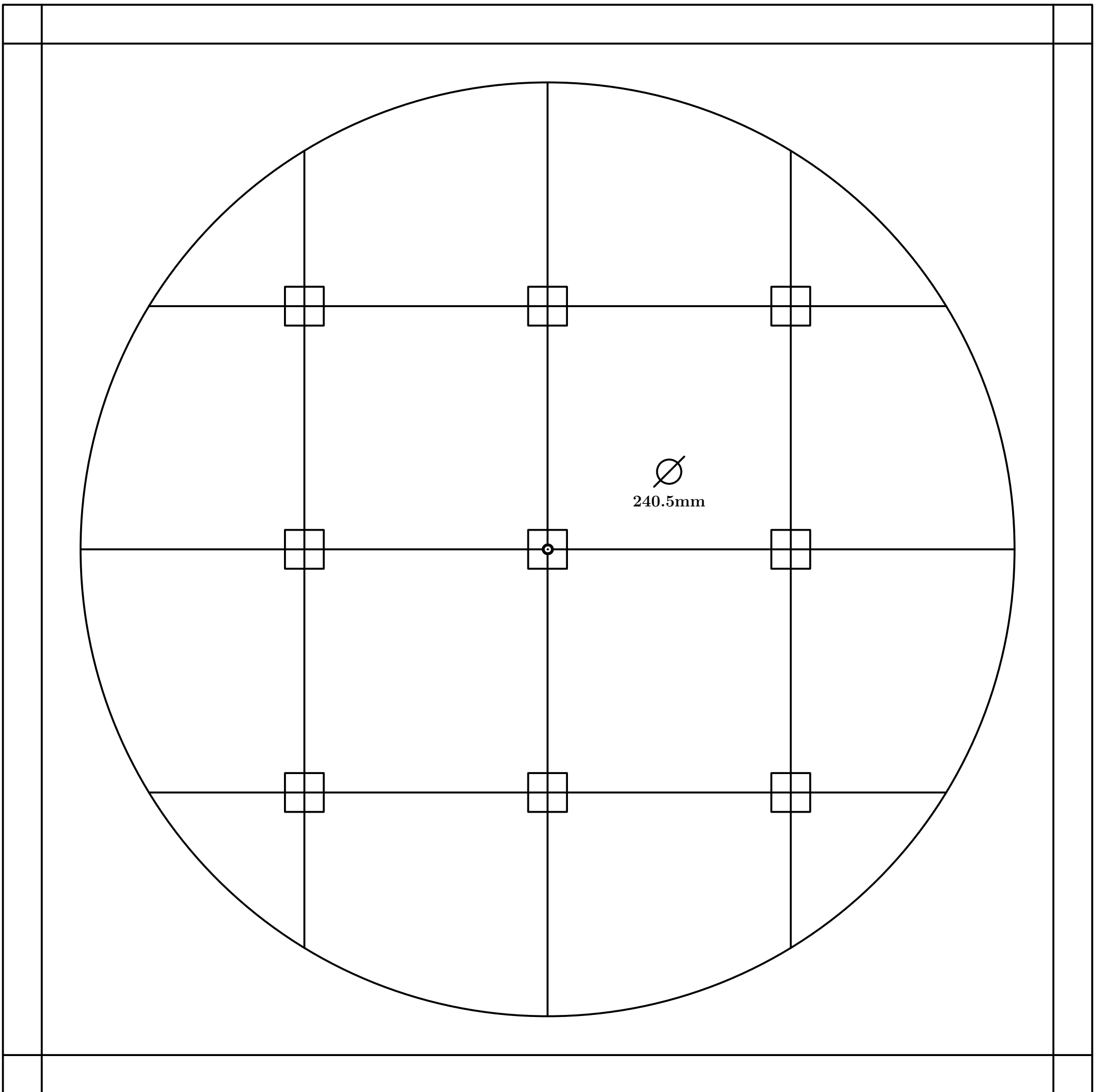

Fig. 563

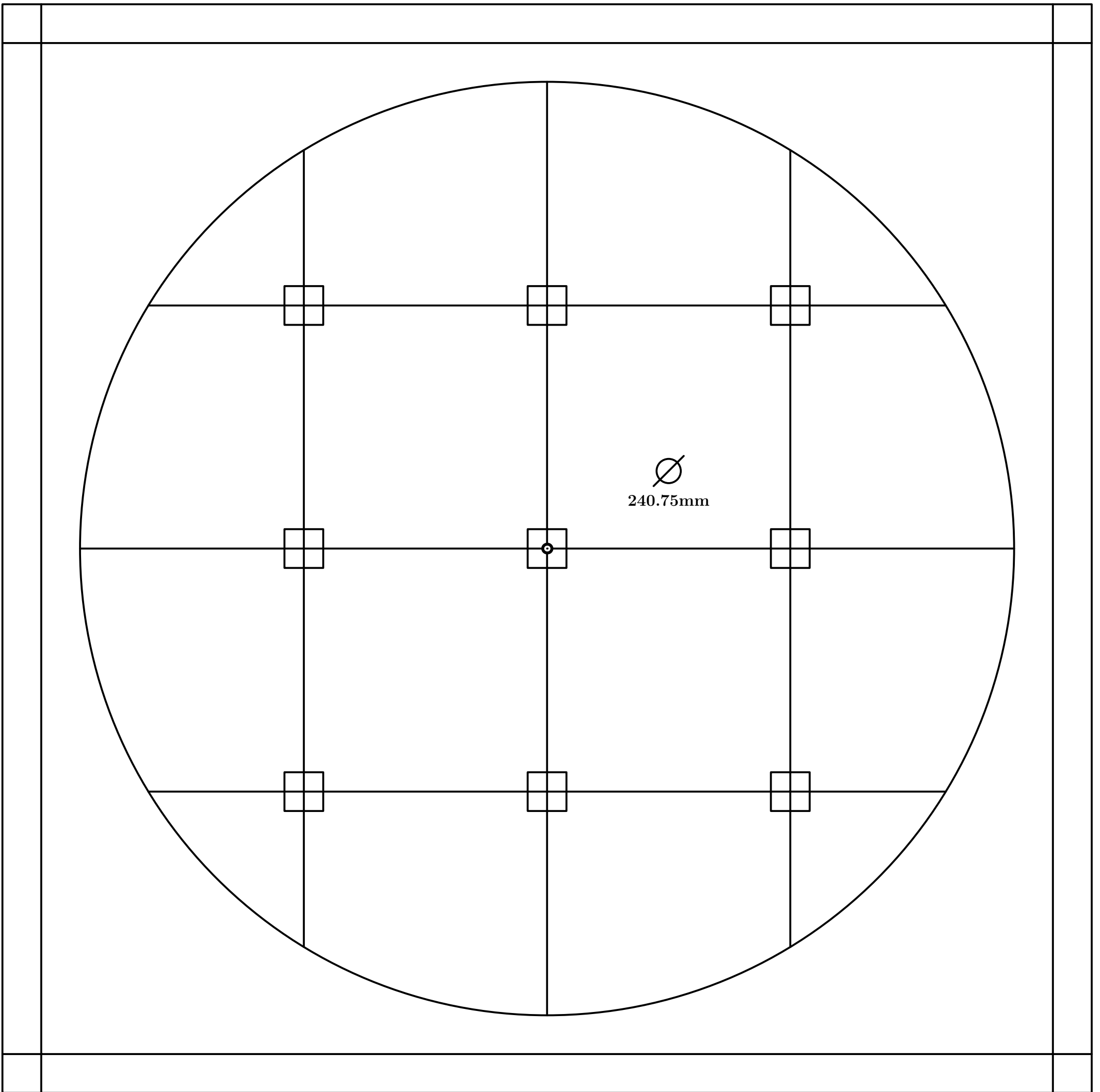

Fig. 564

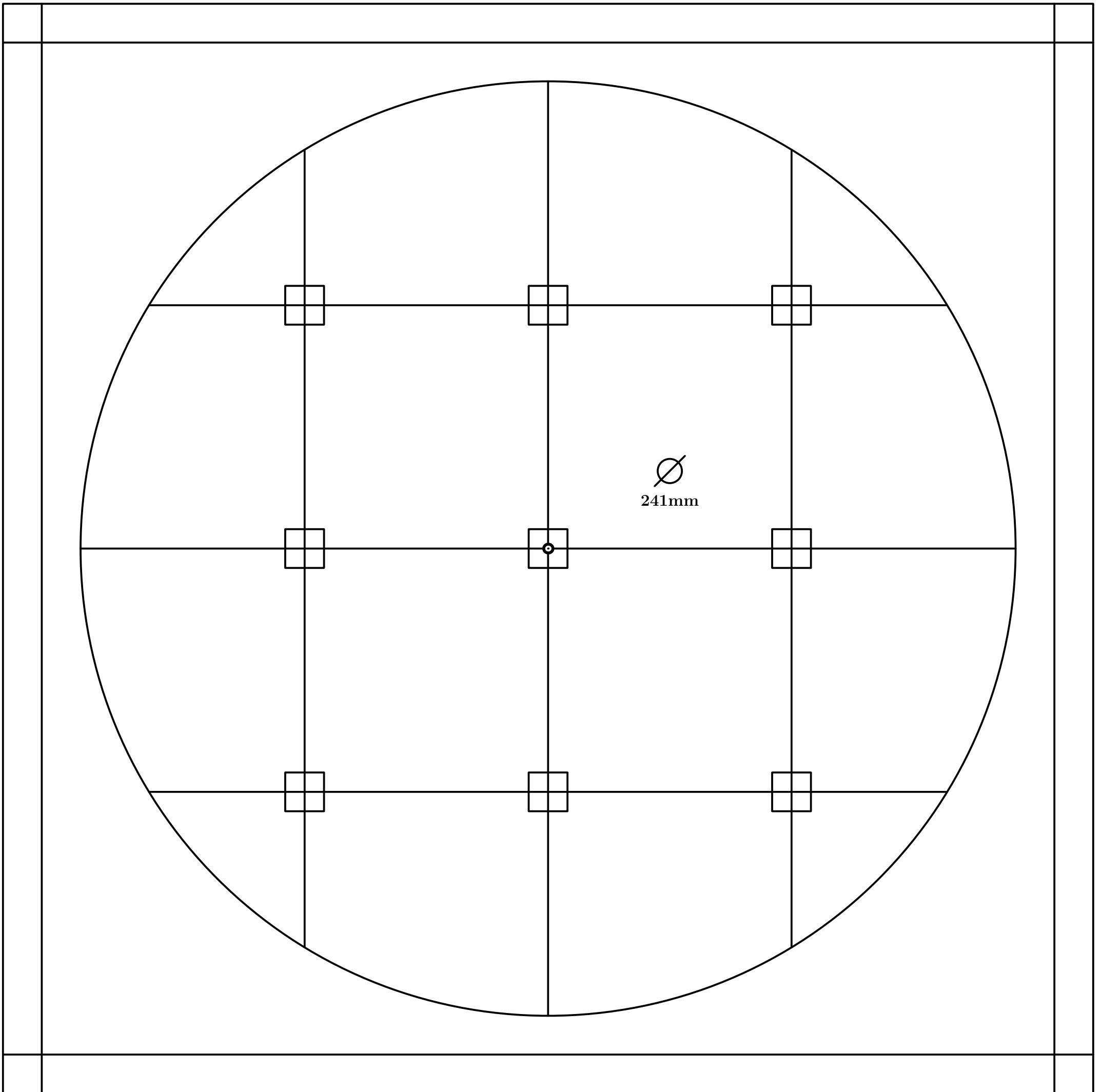

Fig. 565

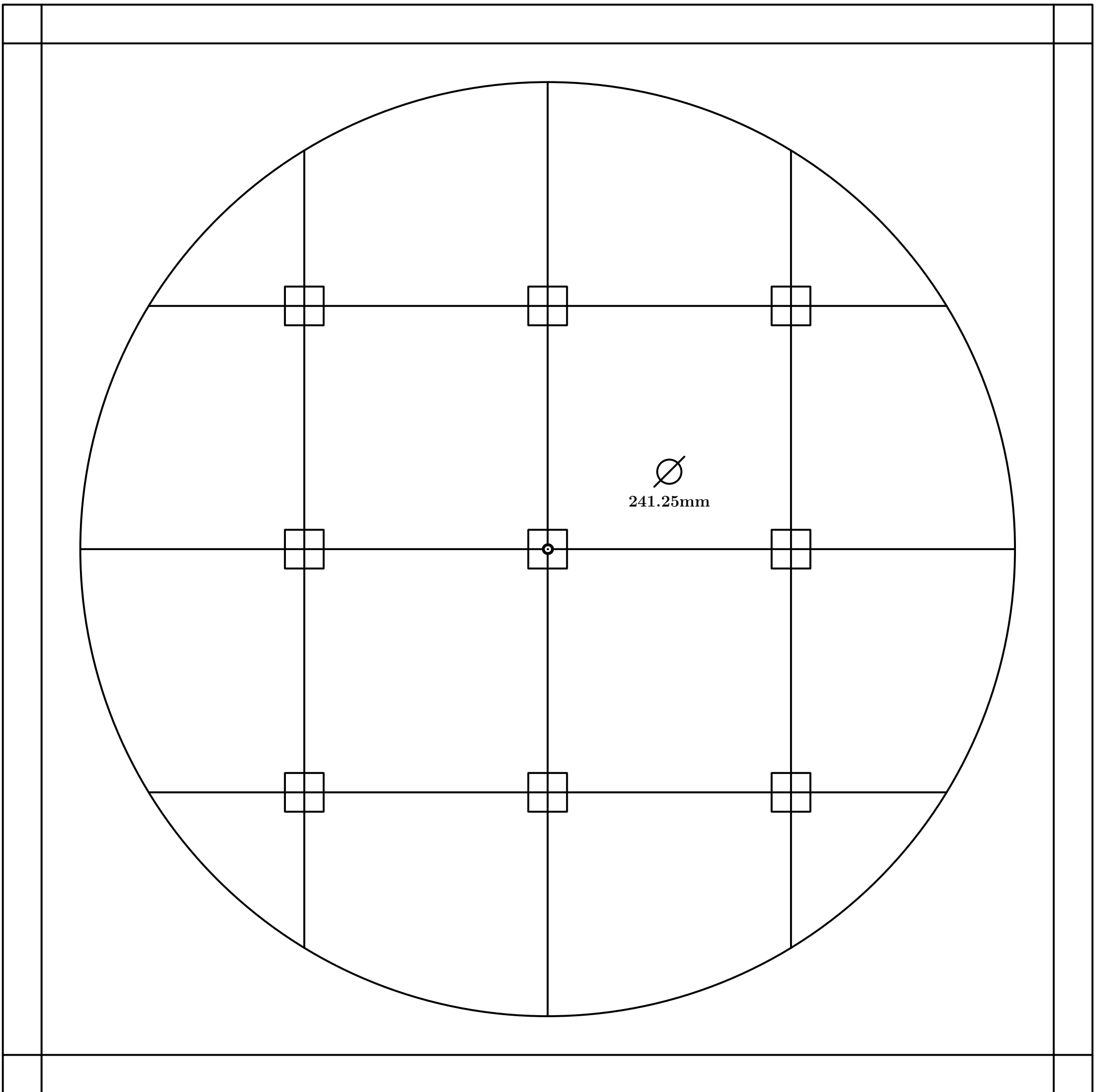

Fig. 566

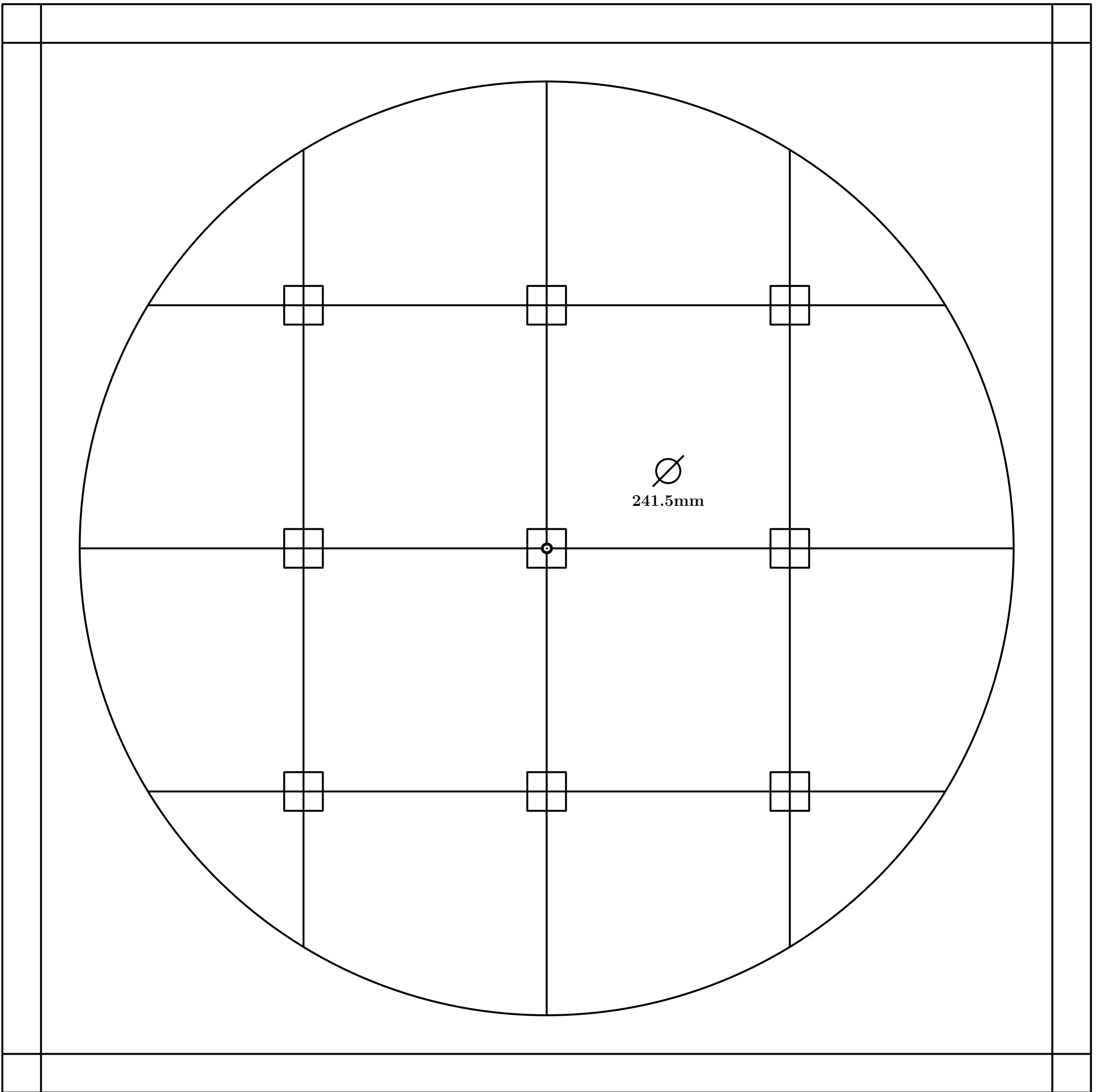

Fig. 567

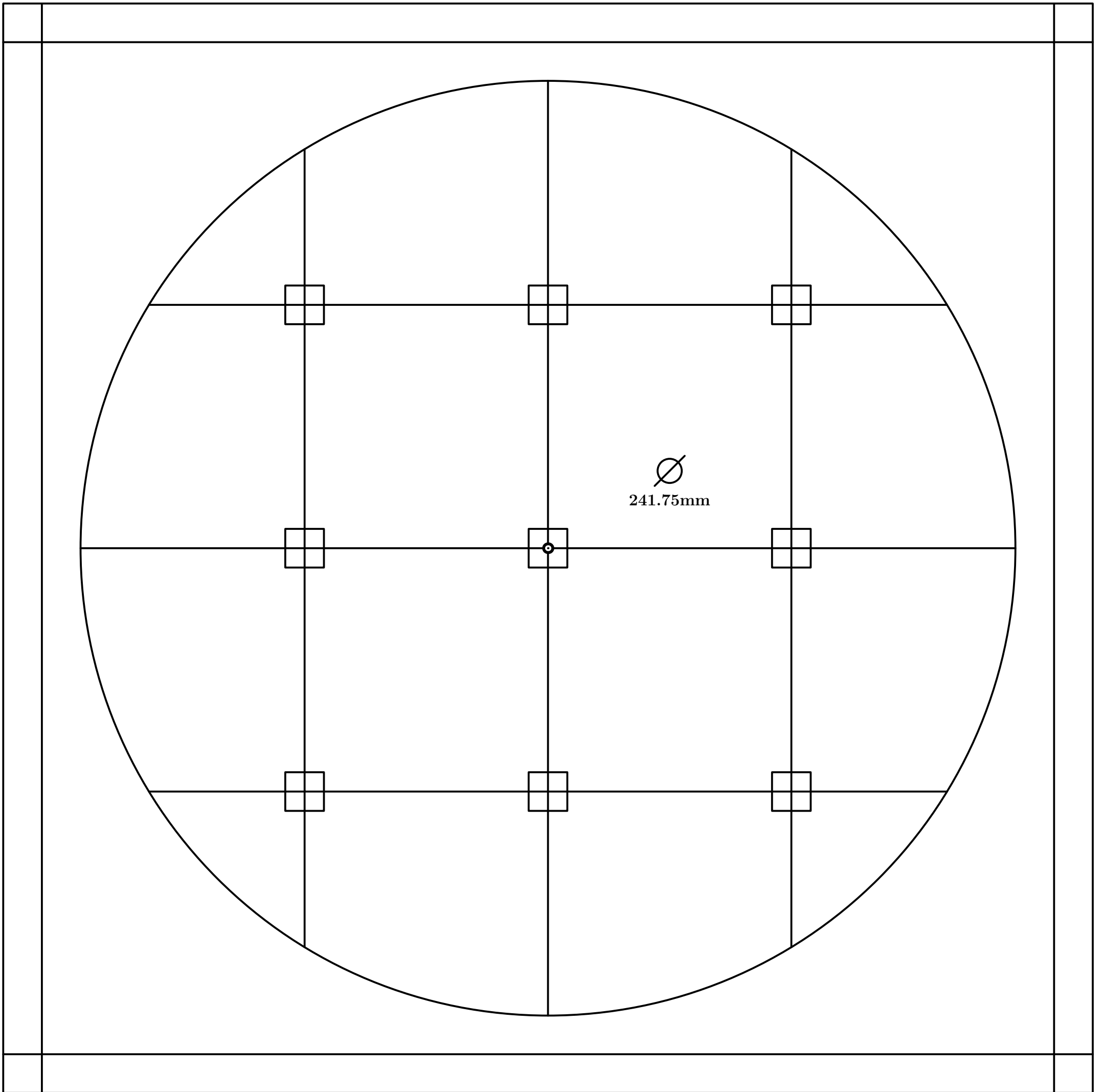

Fig. 568

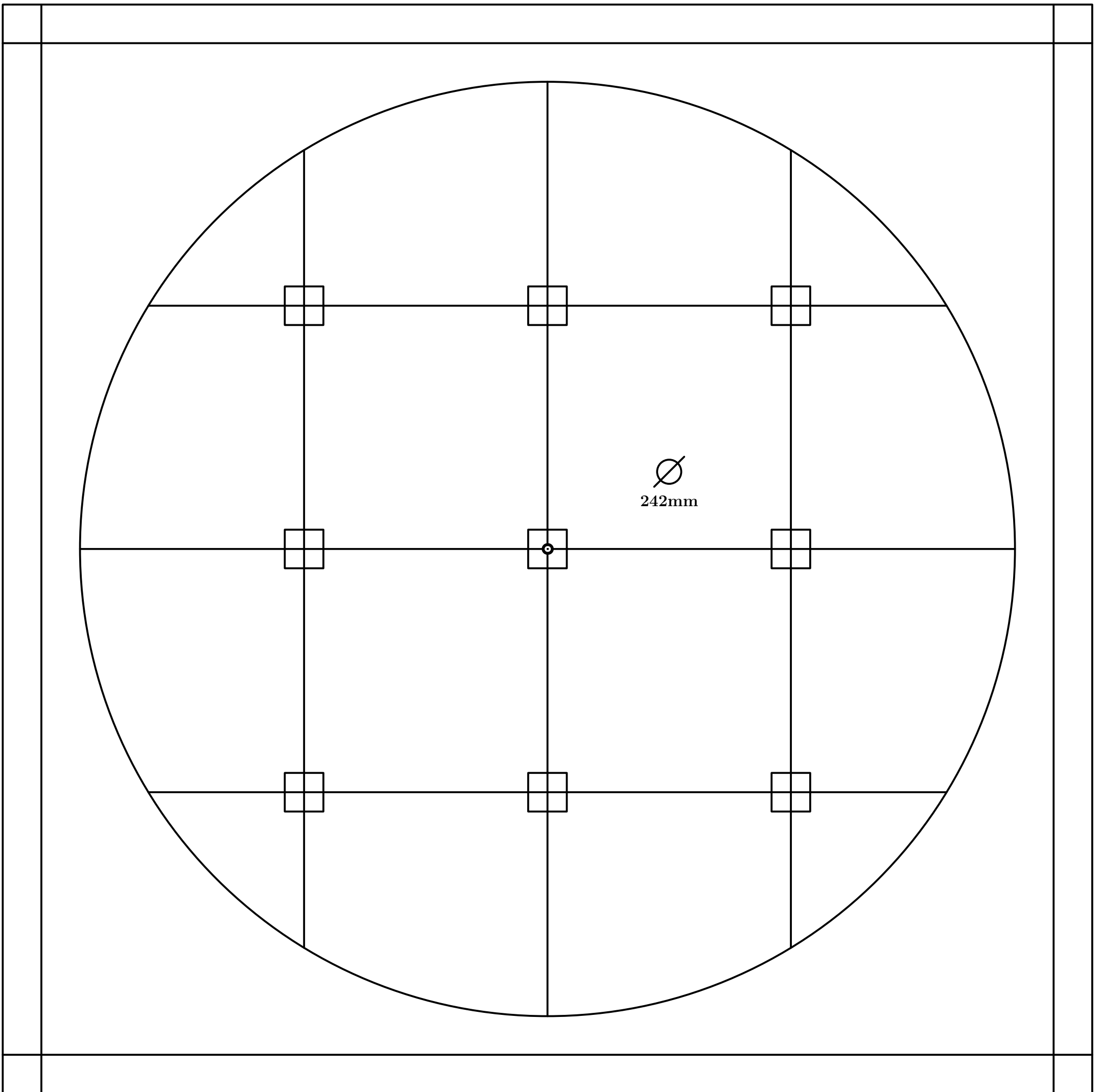

Fig. 569

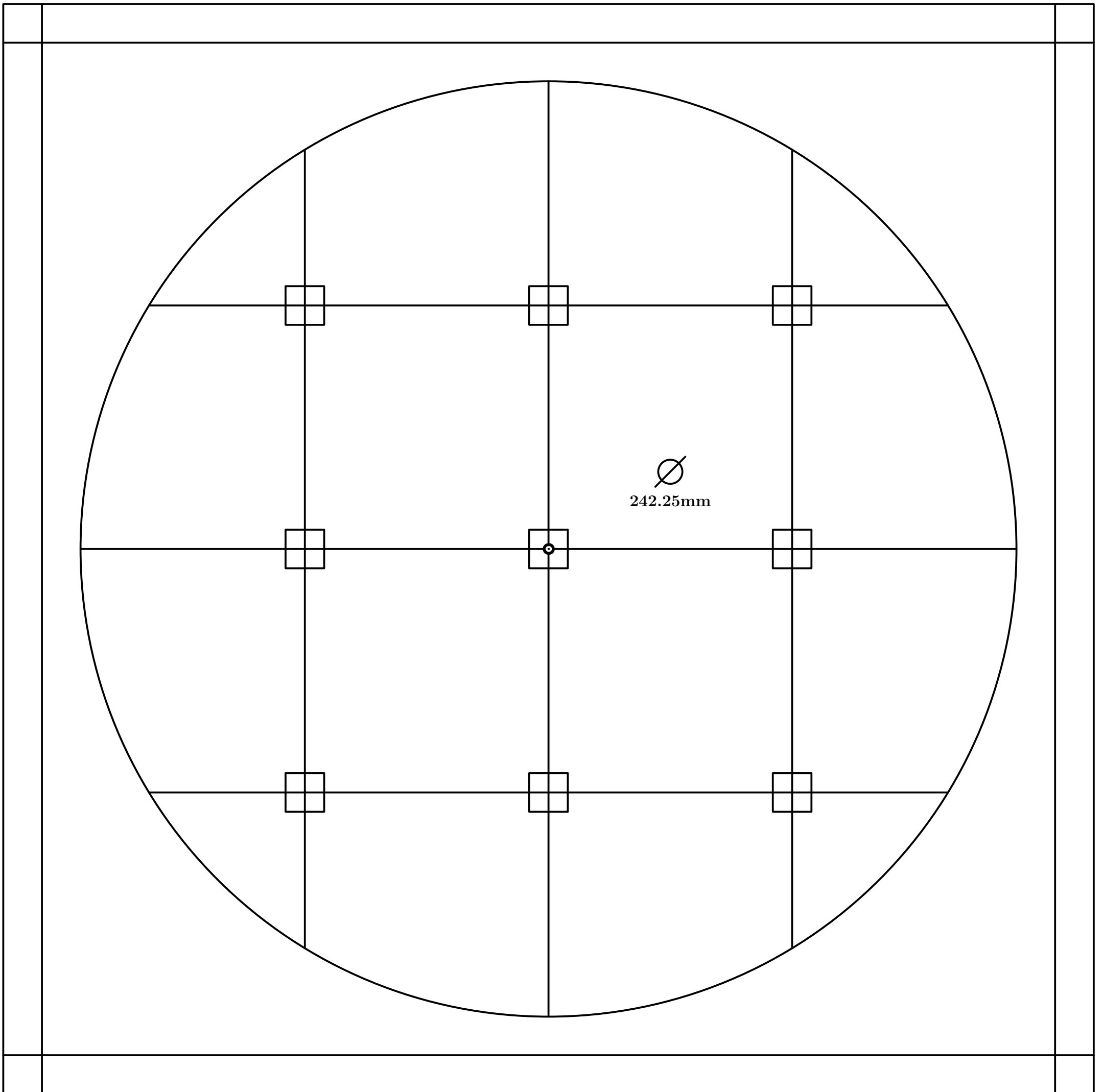

Fig. 570

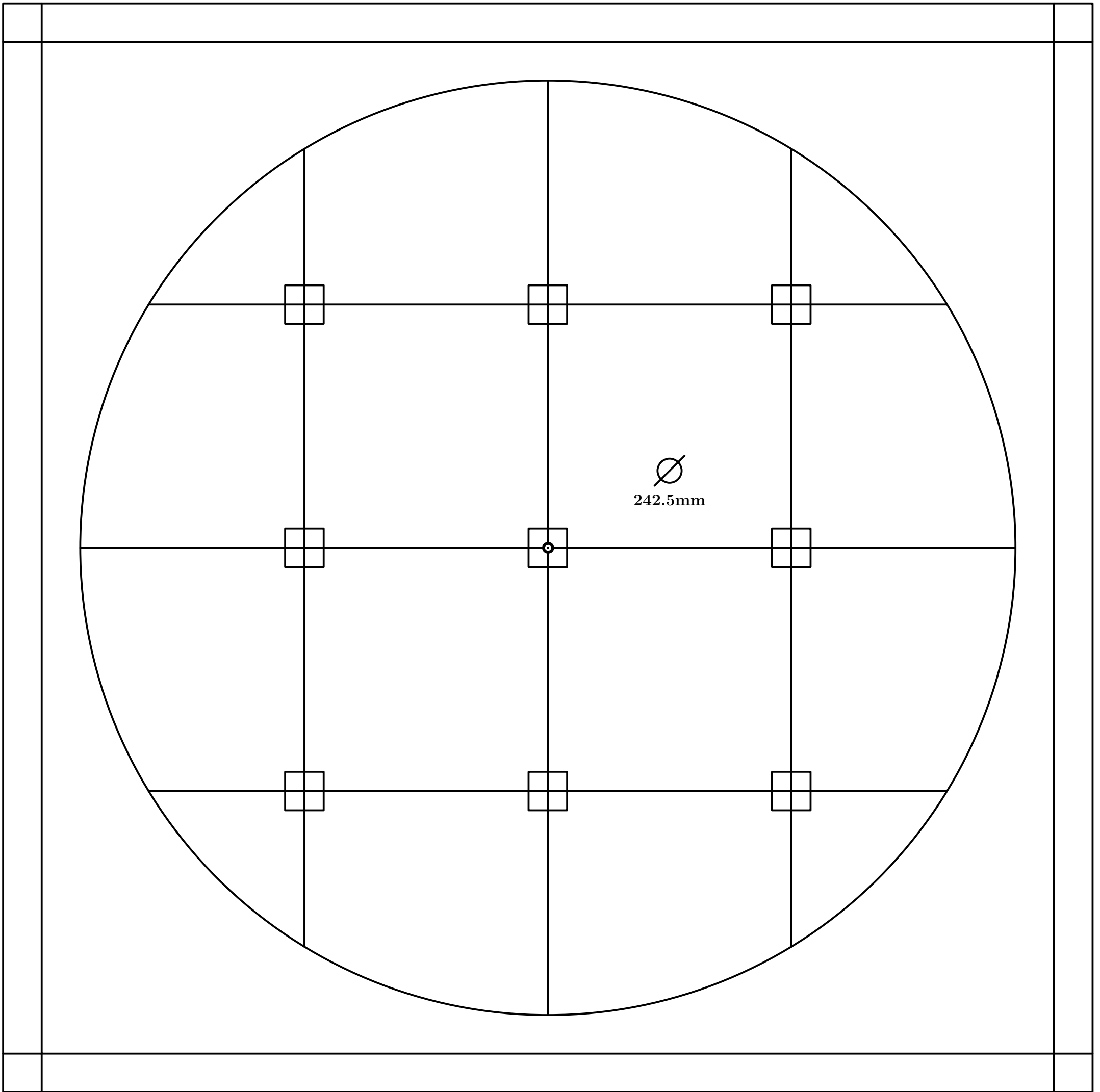

Fig. 571

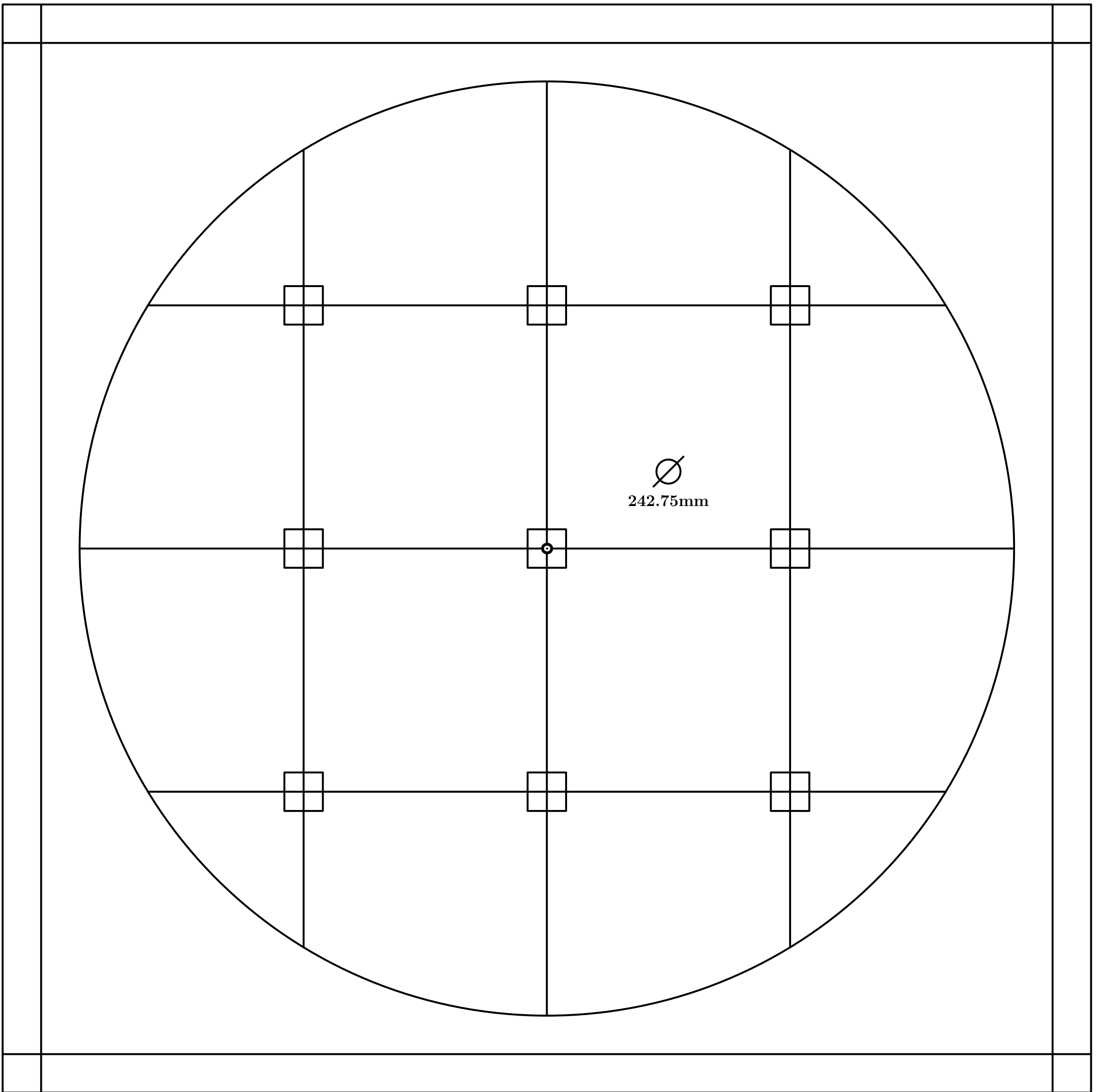

Fig. 572

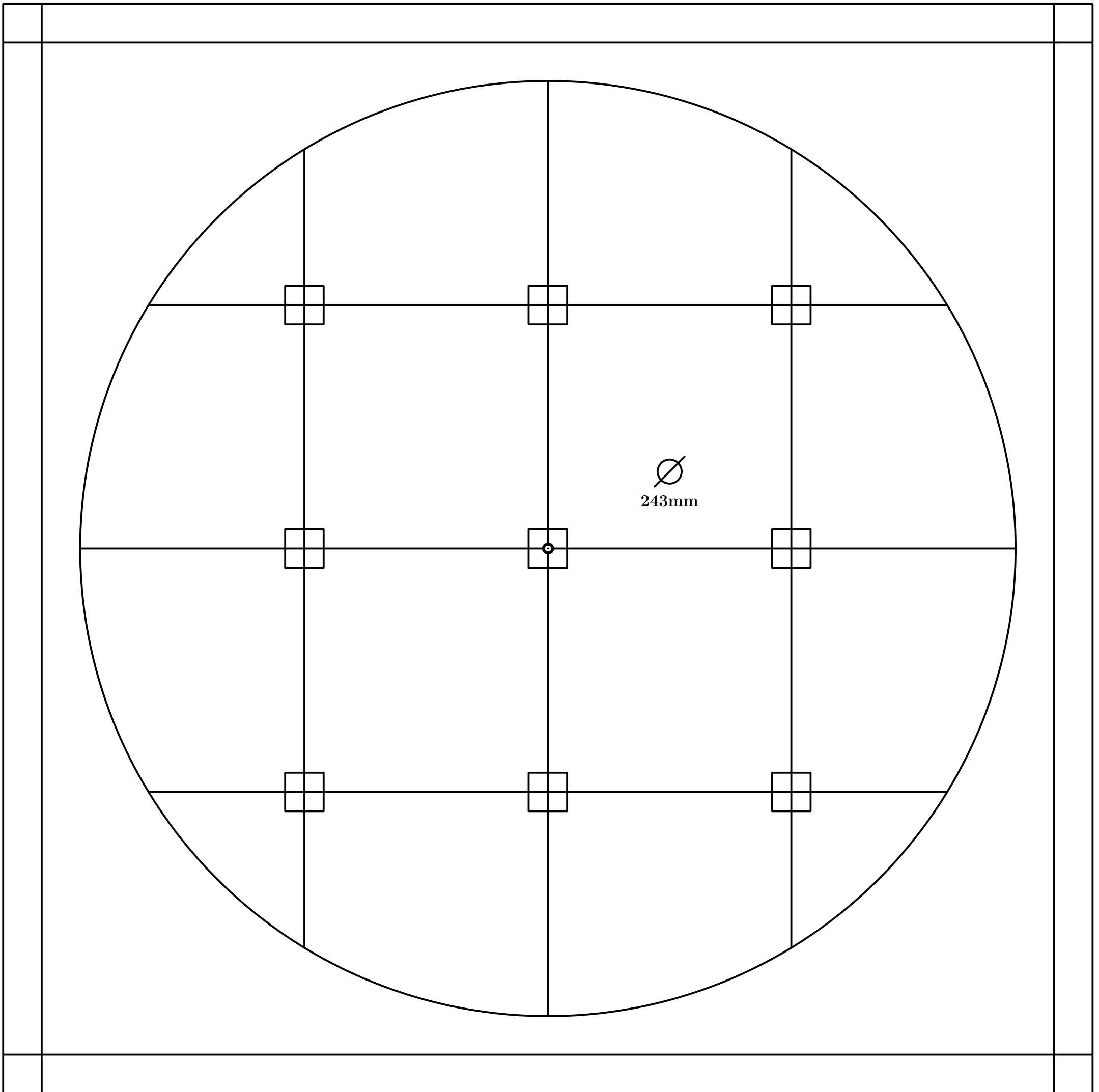

Fig. 573

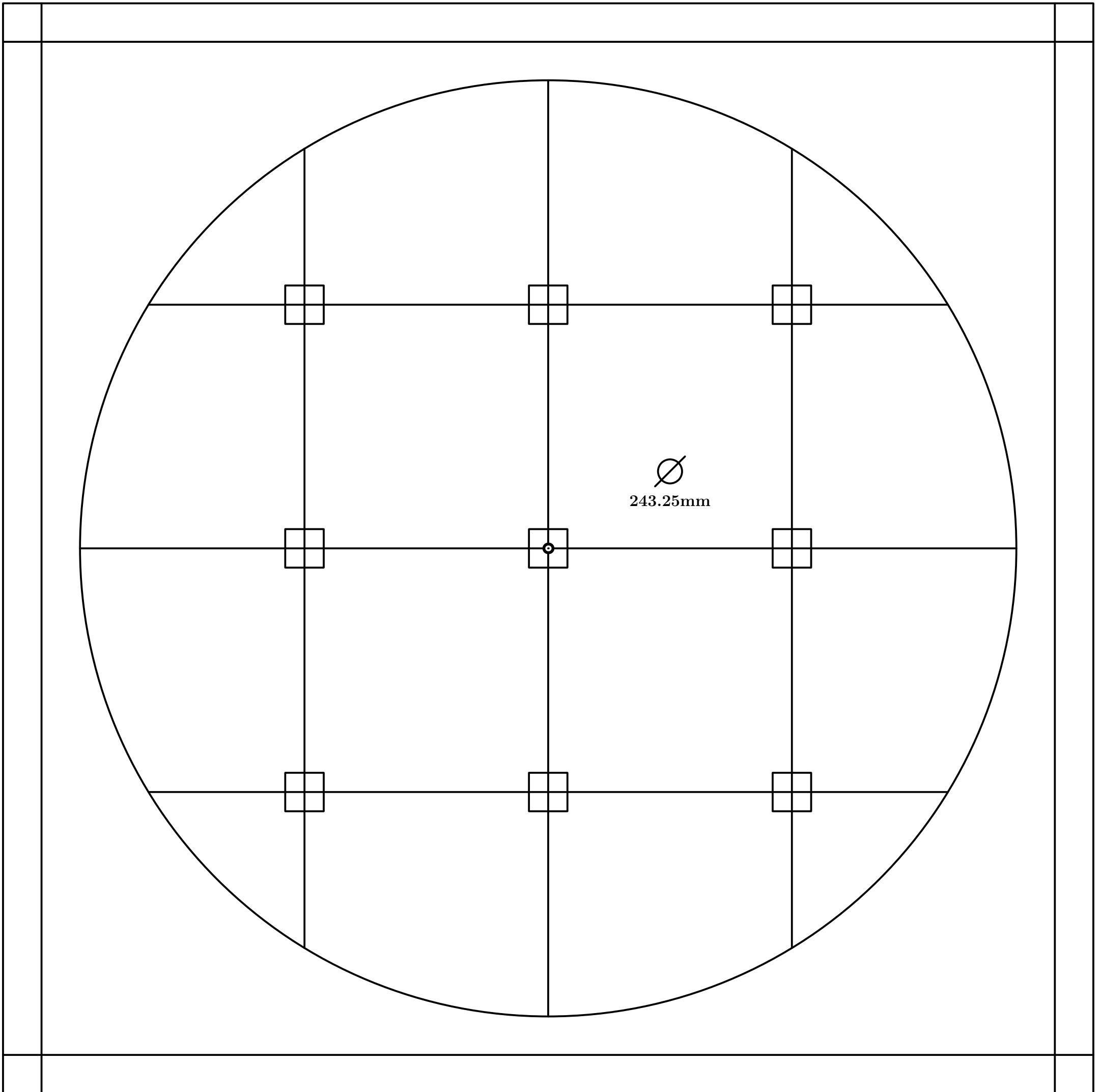

Fig. 574

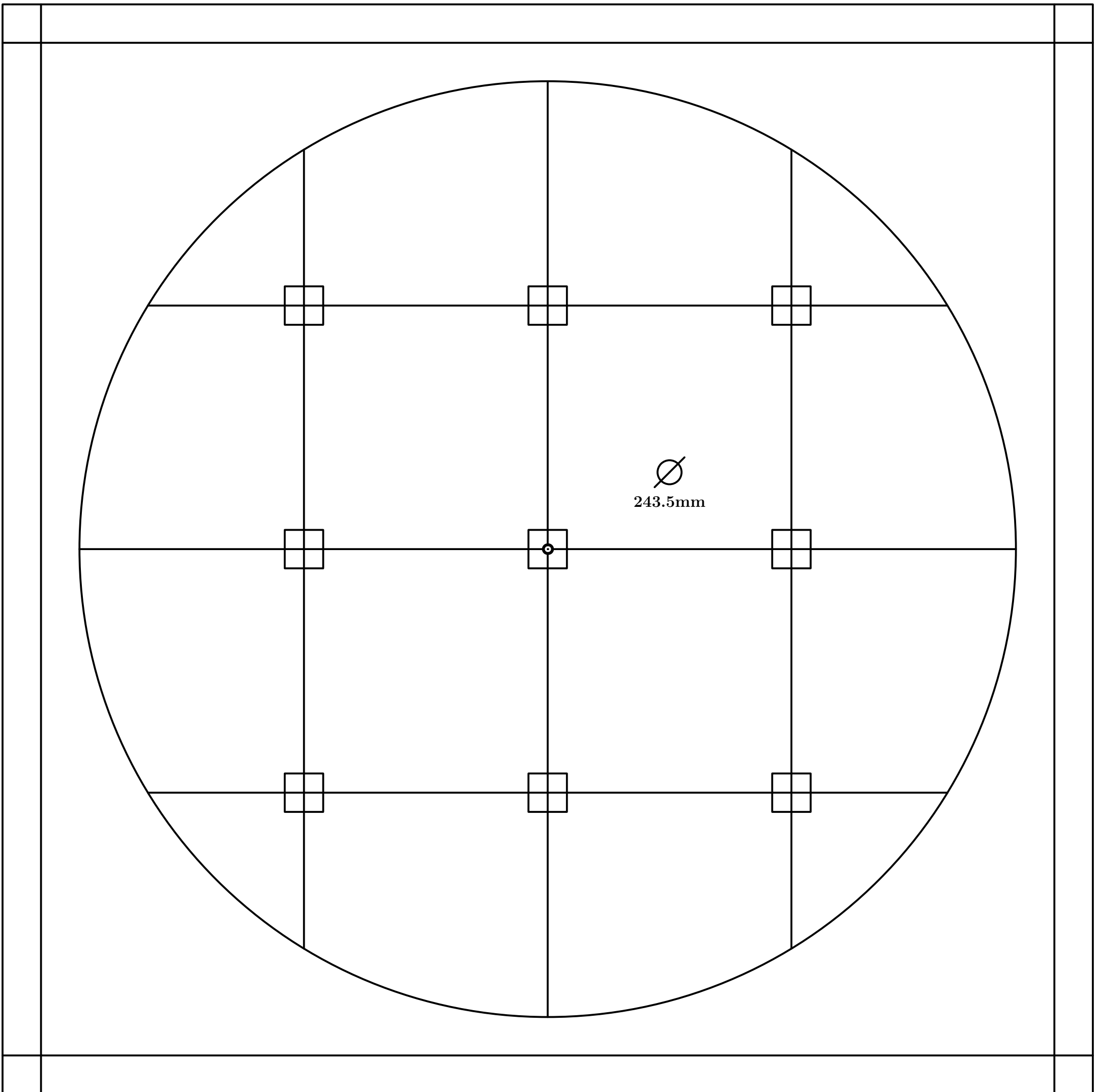

Fig. 575

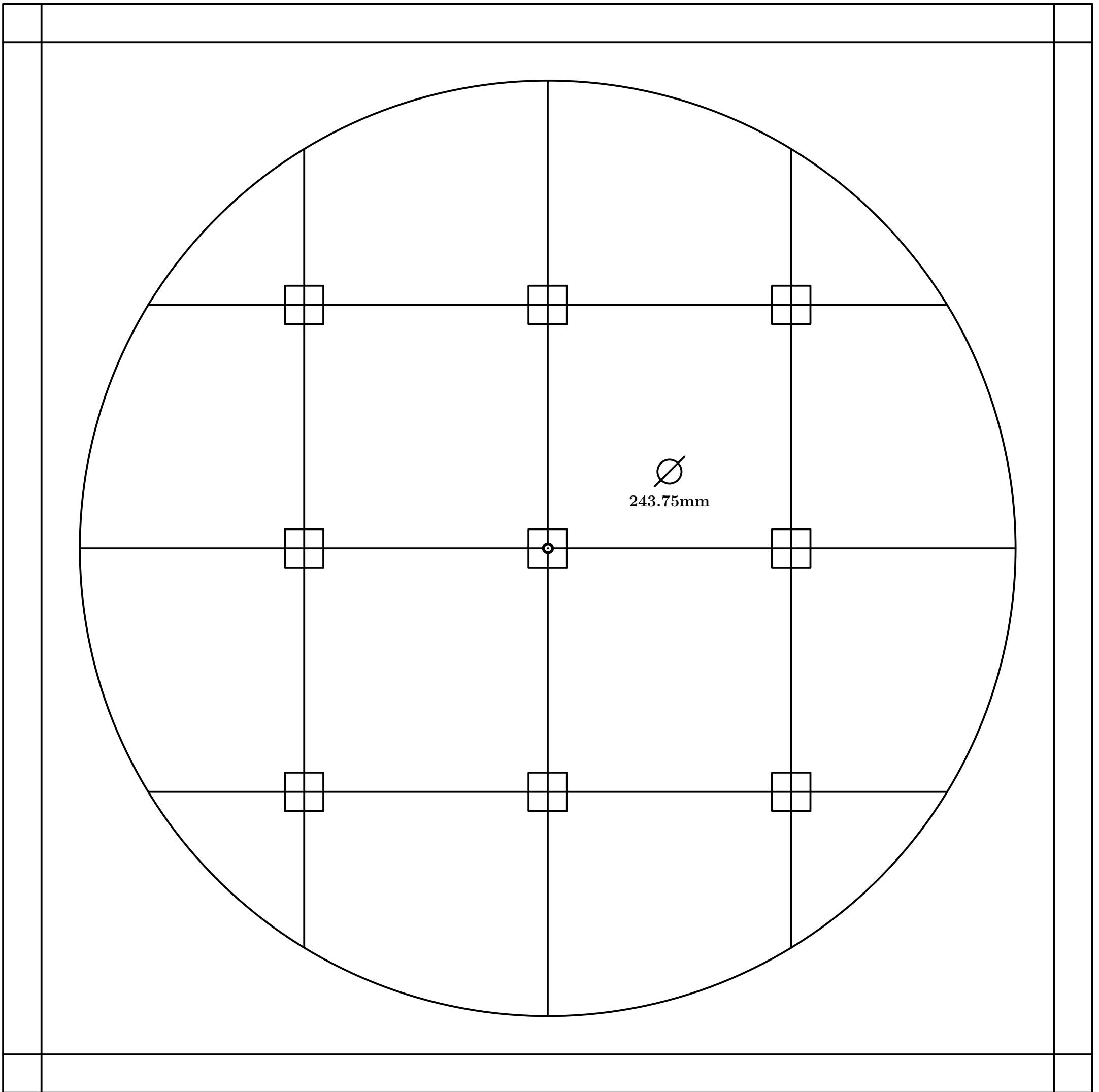

Fig. 576

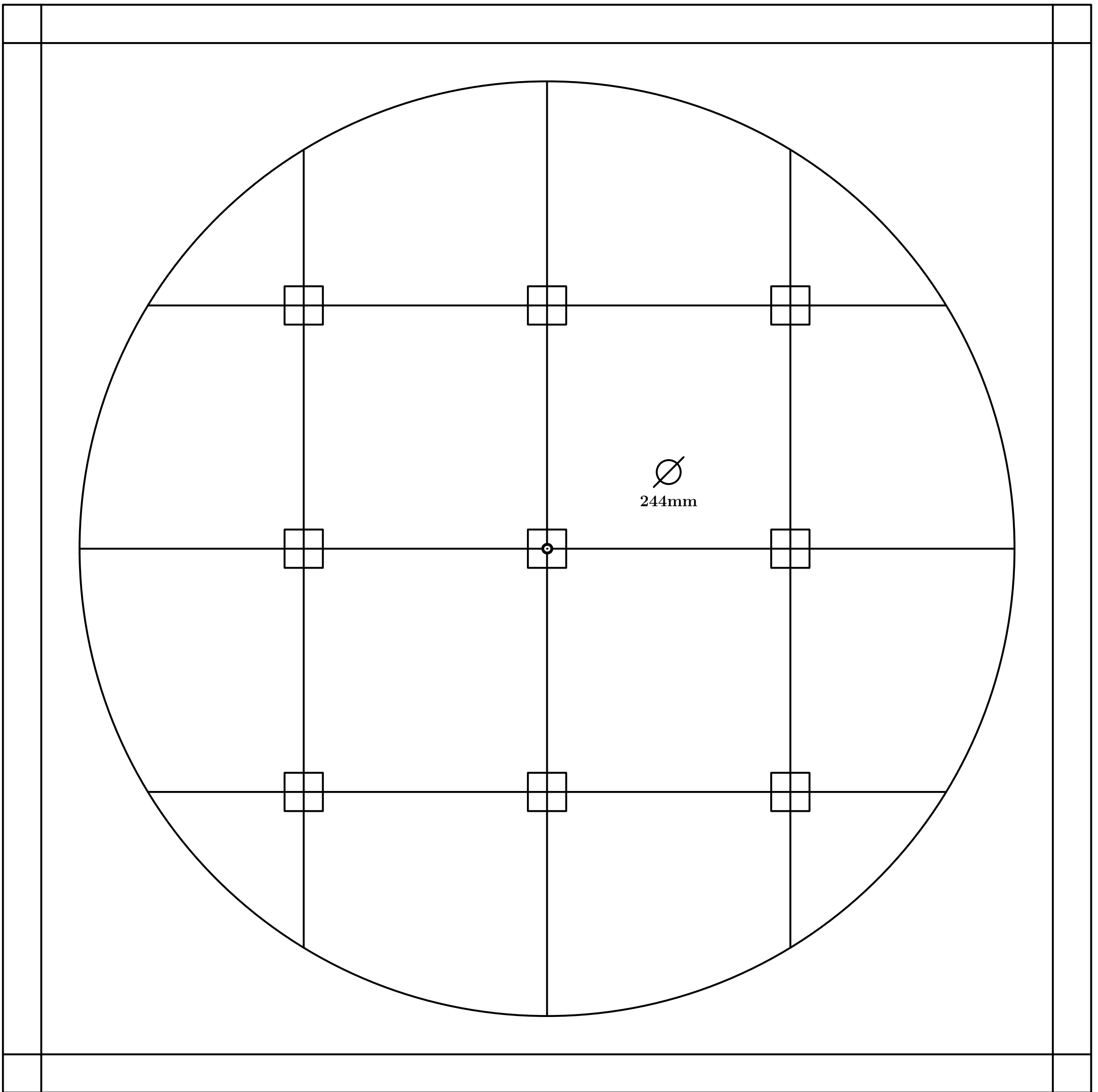

Fig. 577

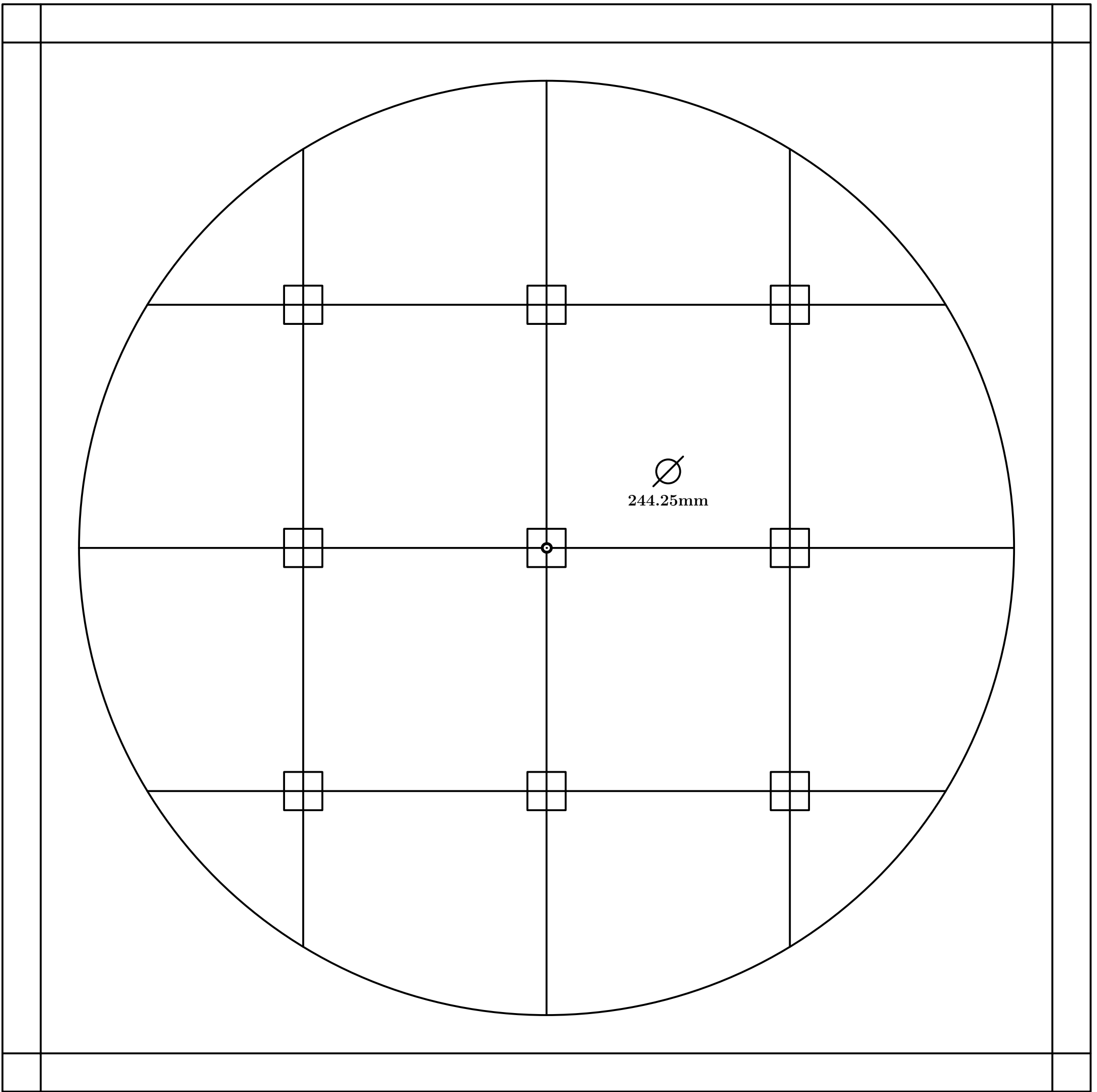

Fig. 578

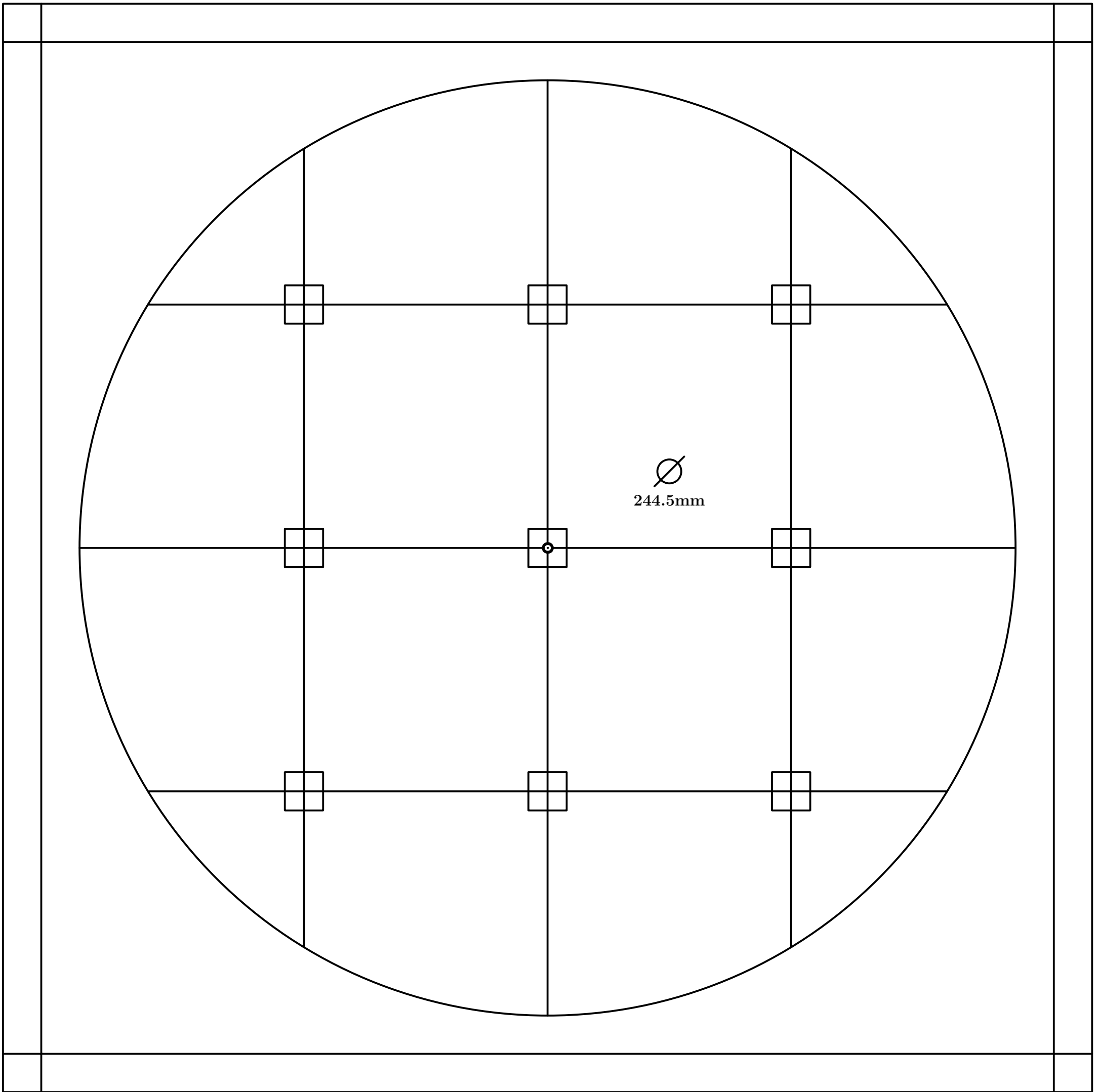

Fig. 579

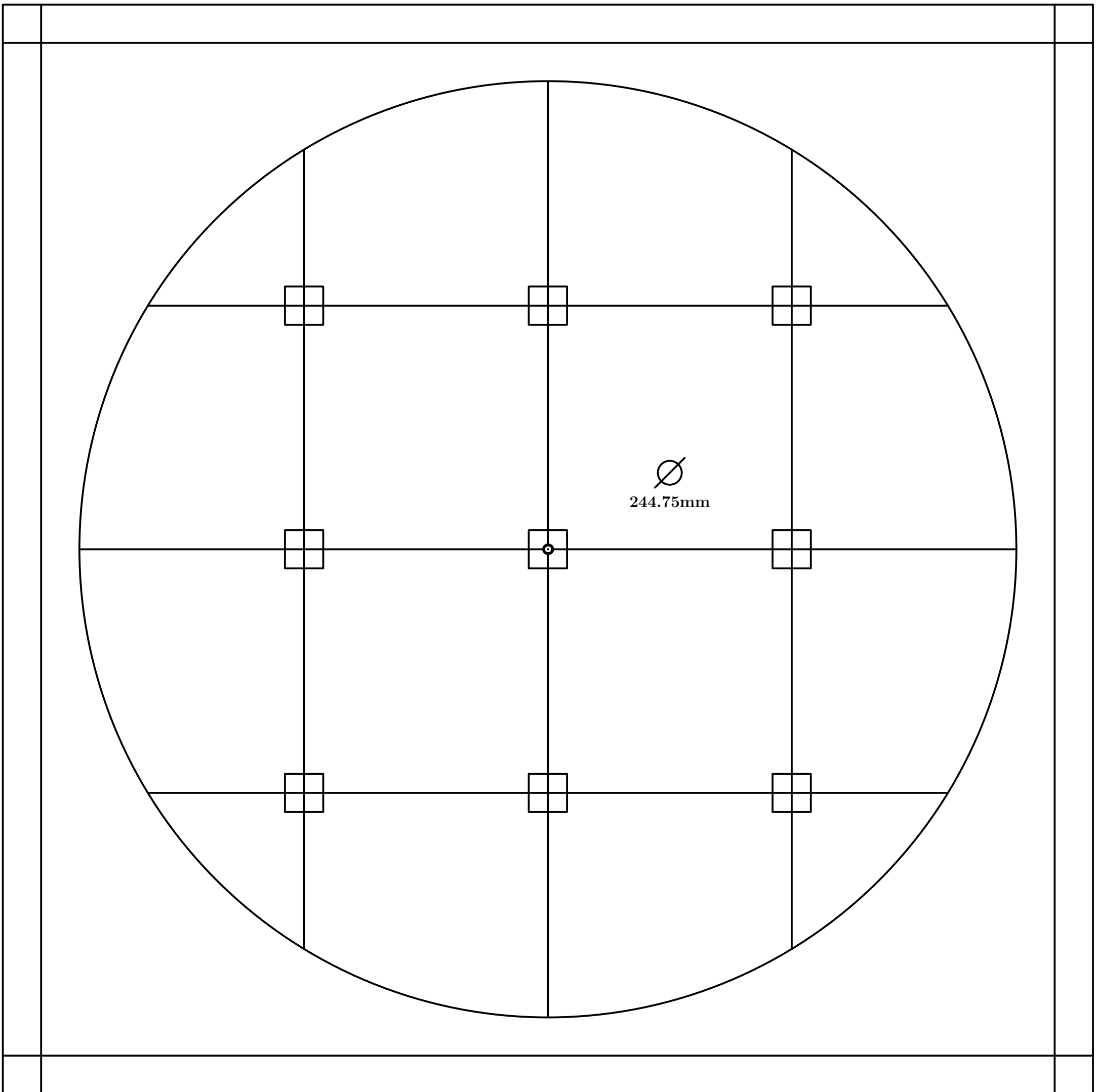

Fig. 580

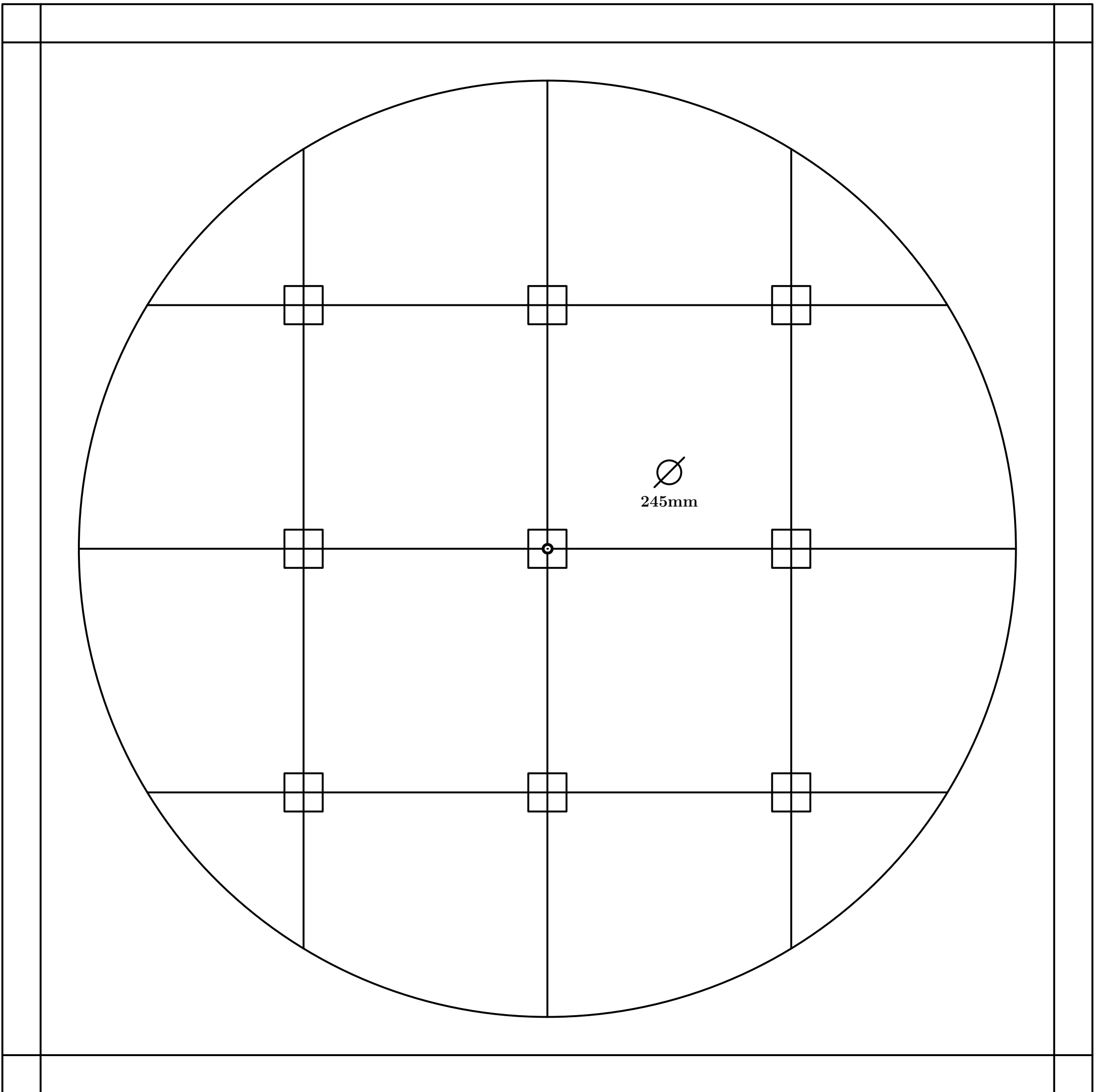

Fig. 581

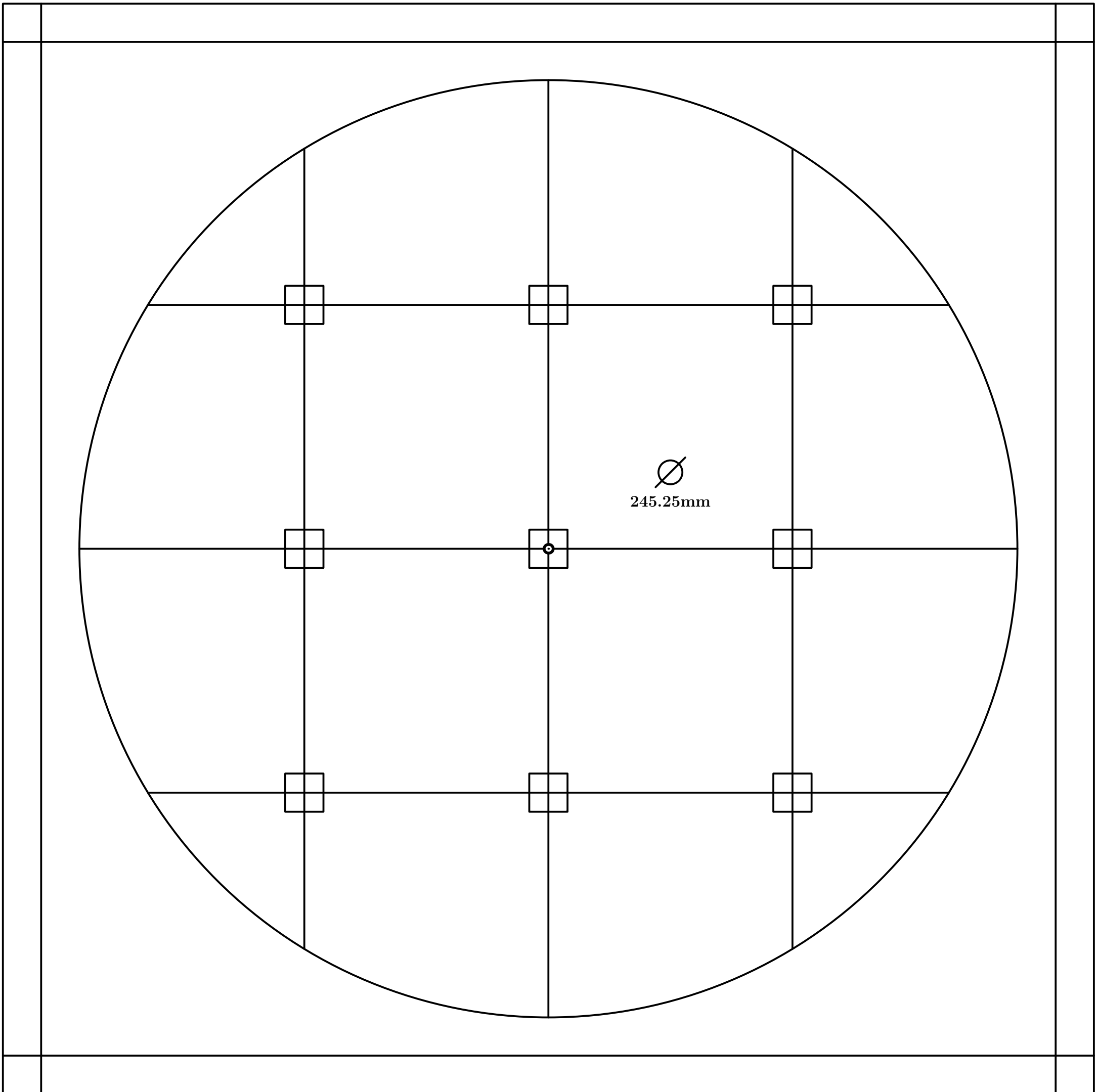

Fig. 582

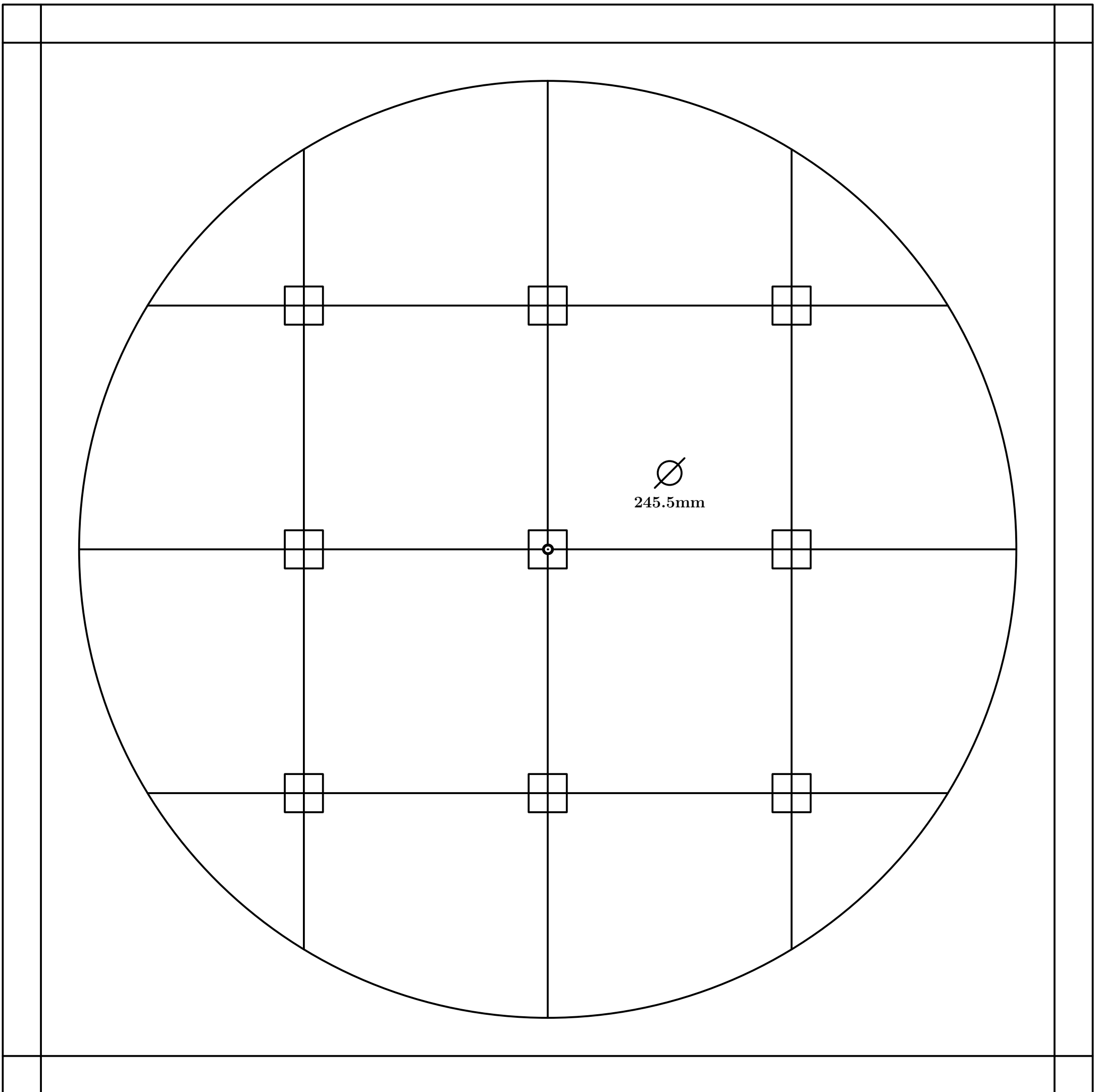

Fig. 583

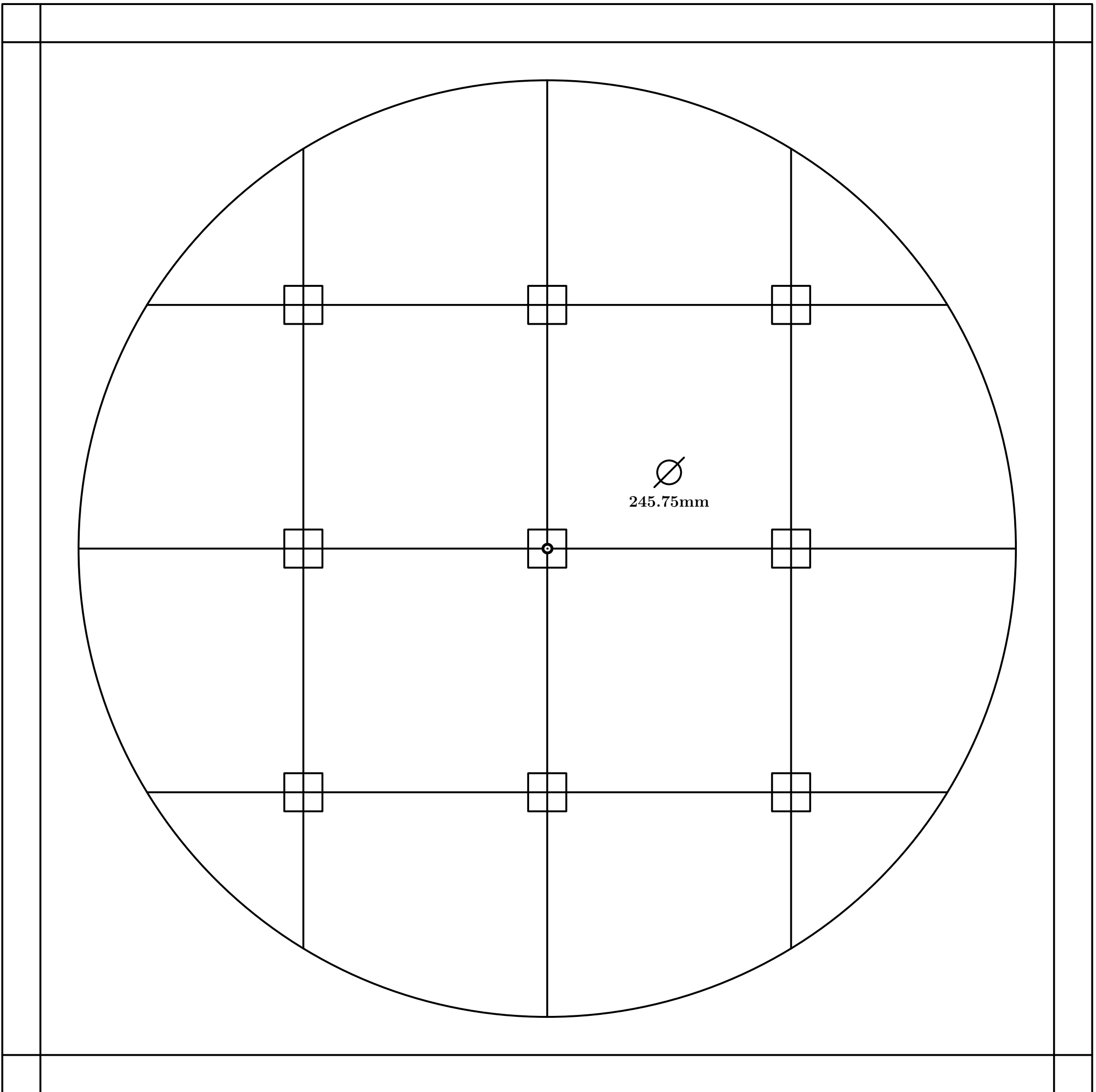

Fig. 584

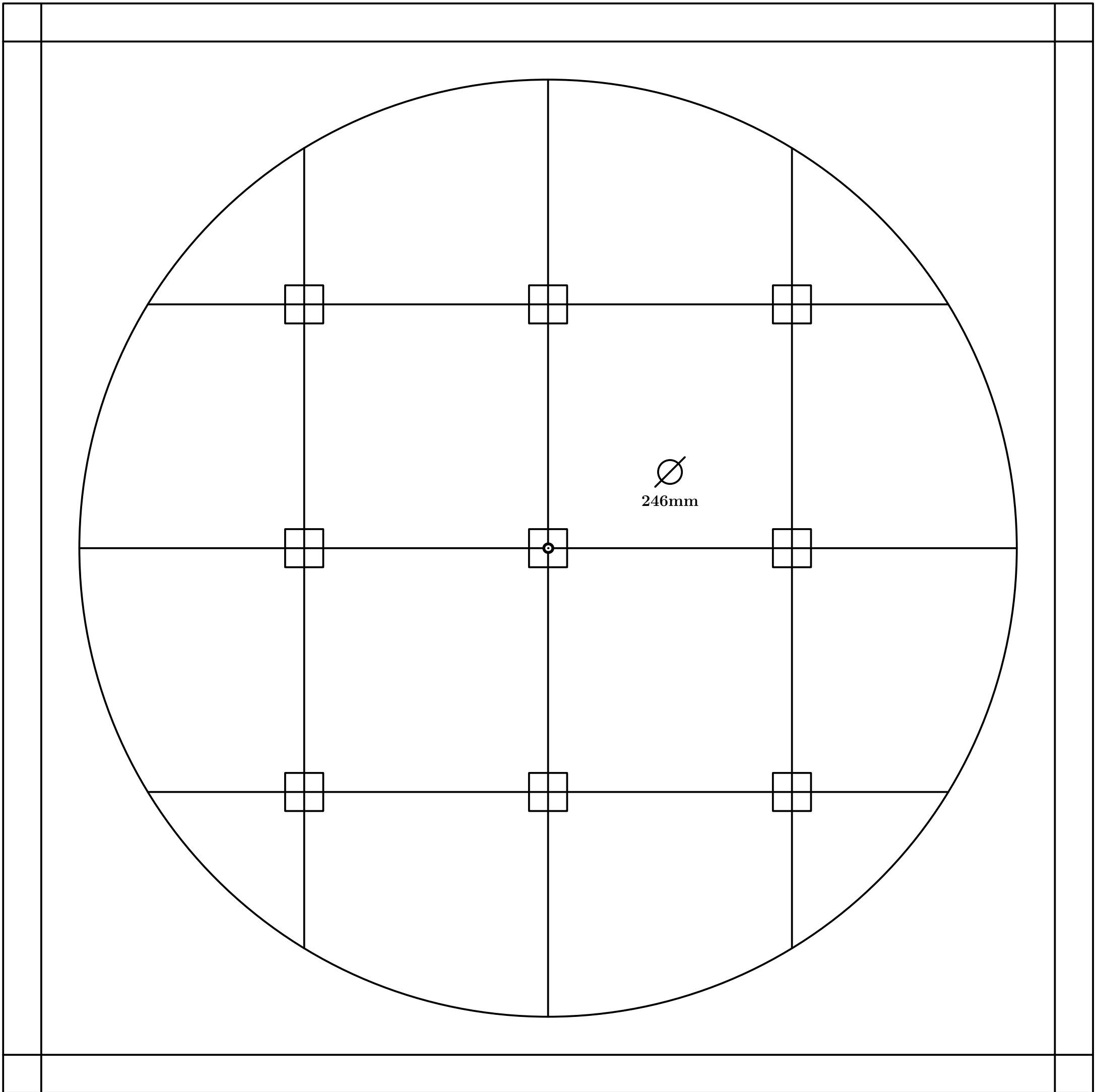

Fig. 585

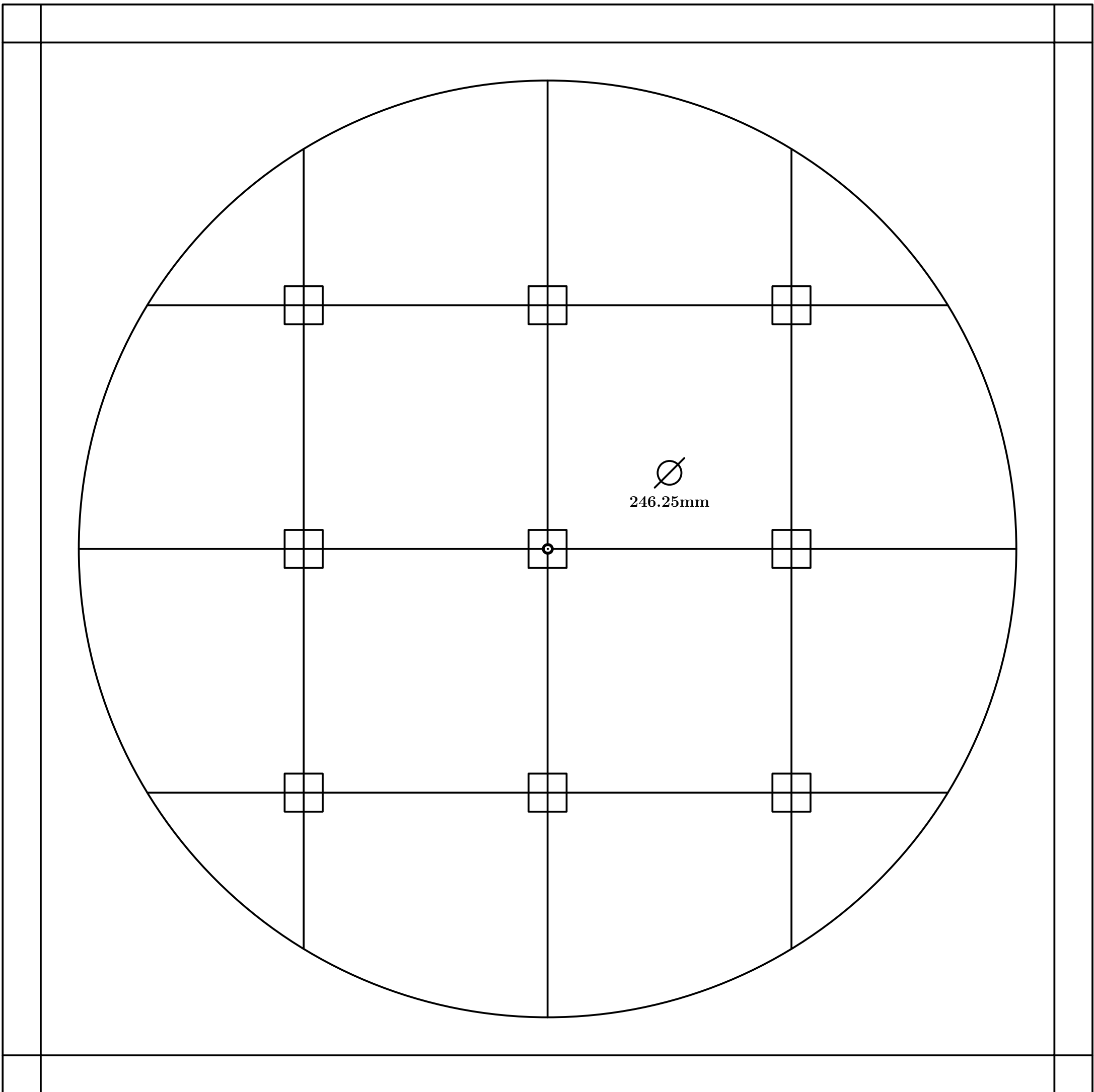

Fig. 586

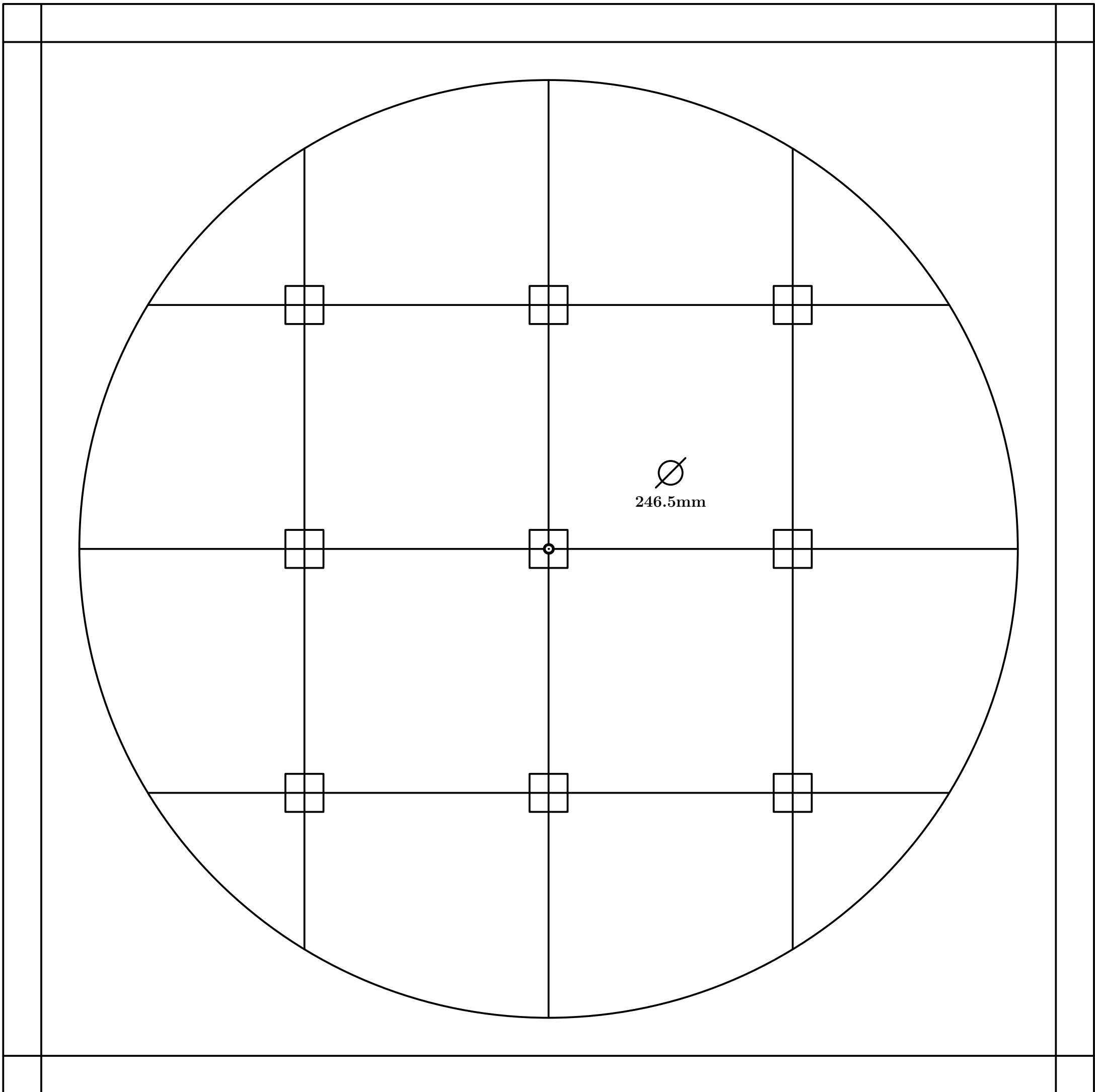

Fig. 587

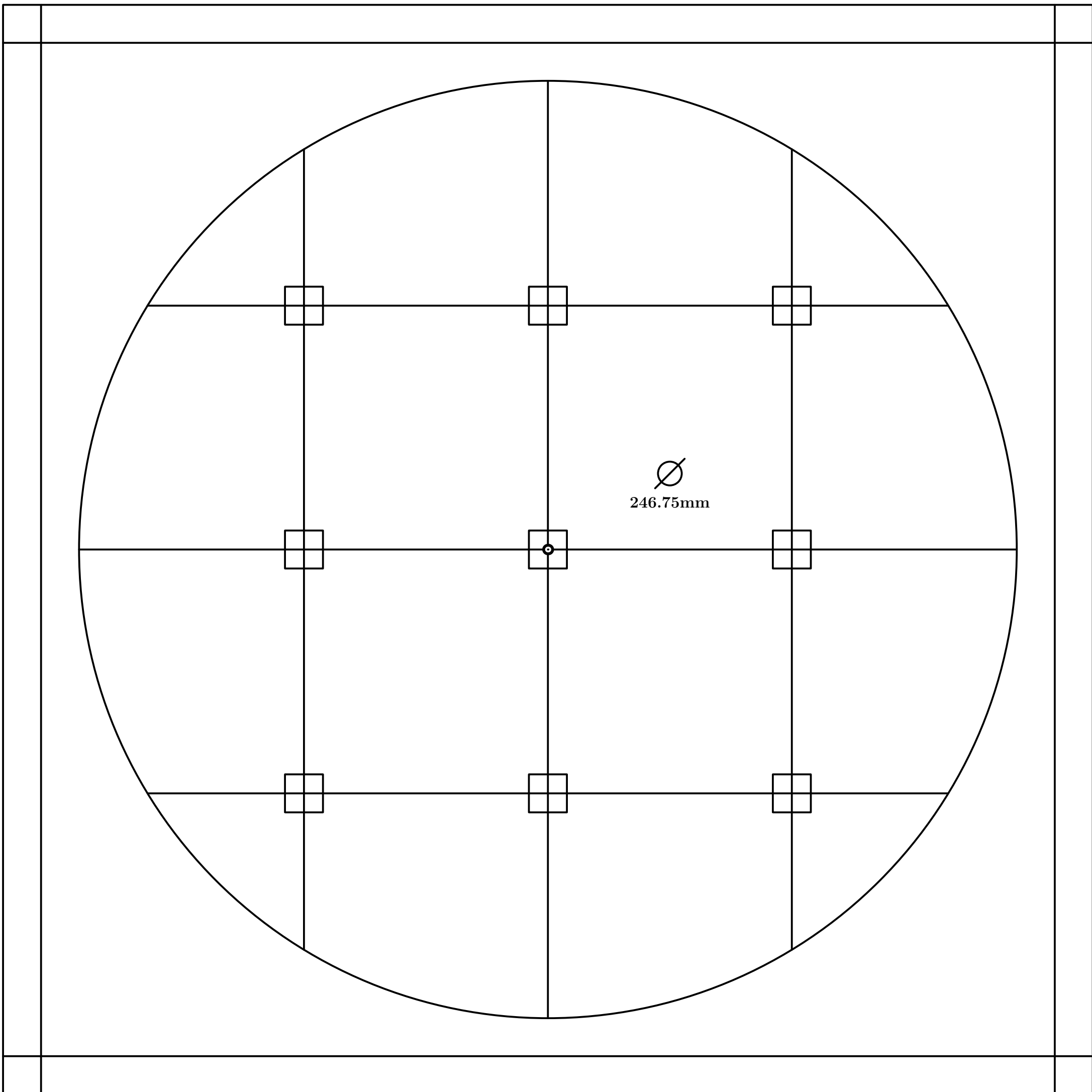

Fig. 588

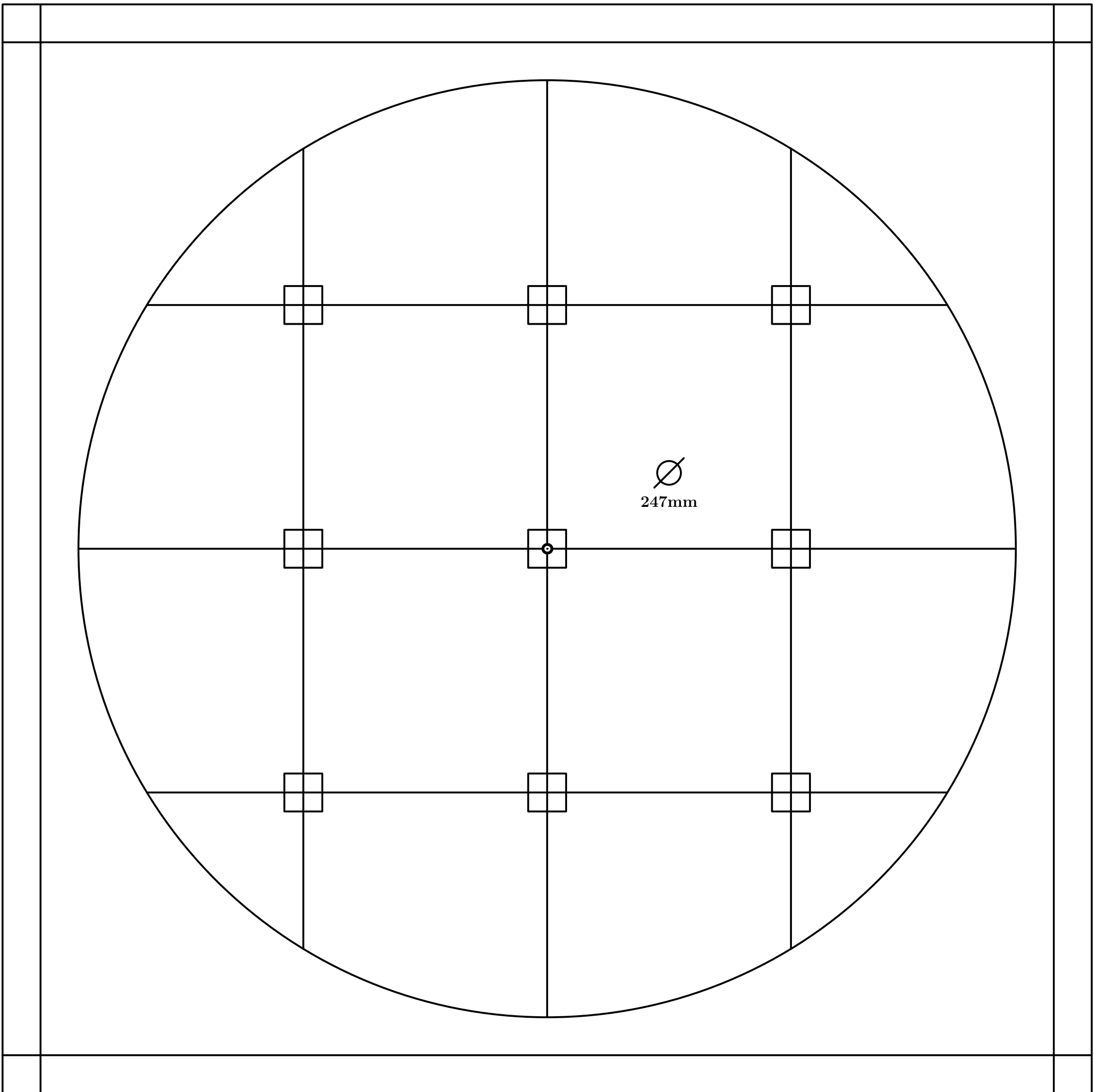

Fig. 589

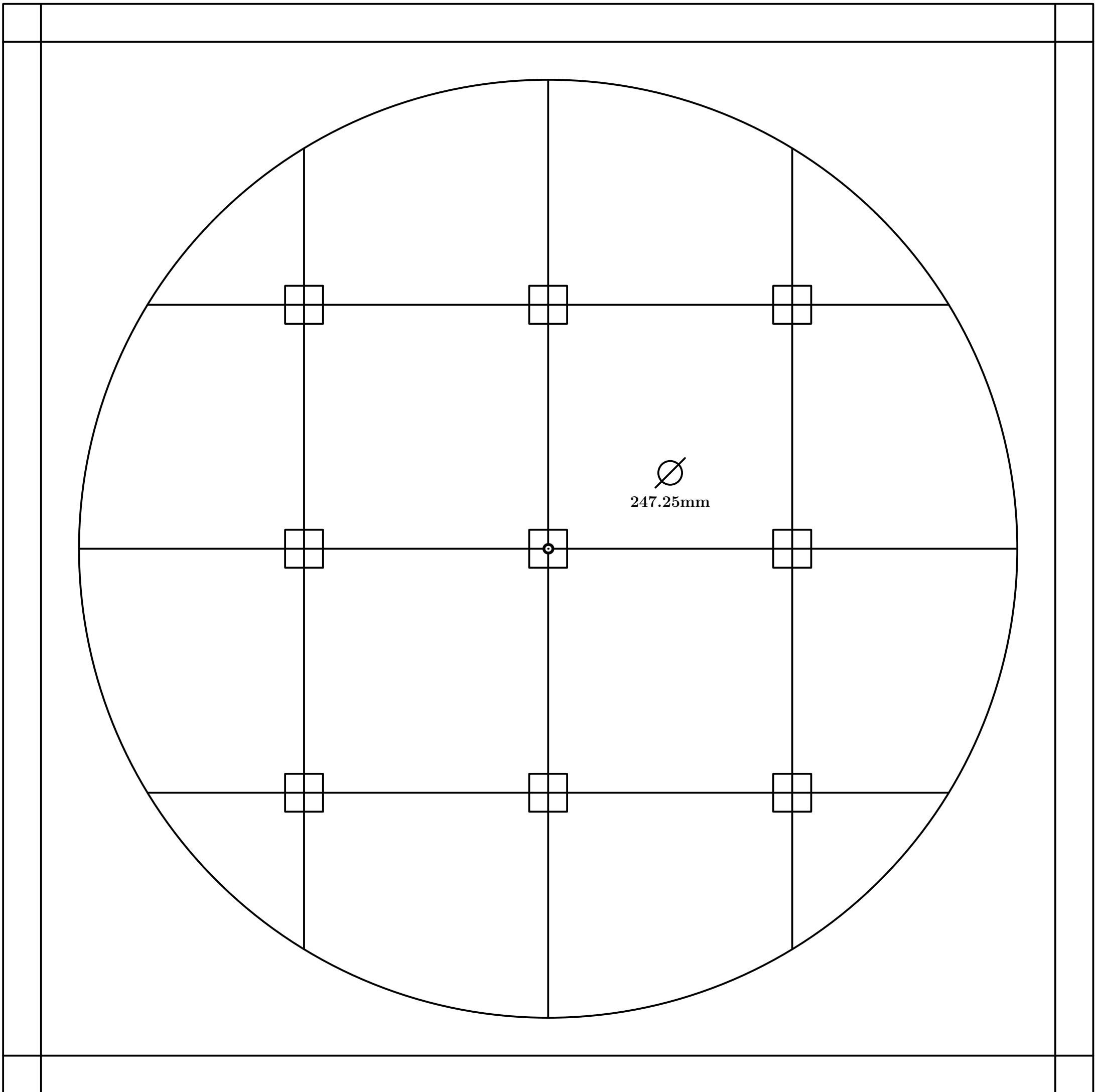

Fig. 590

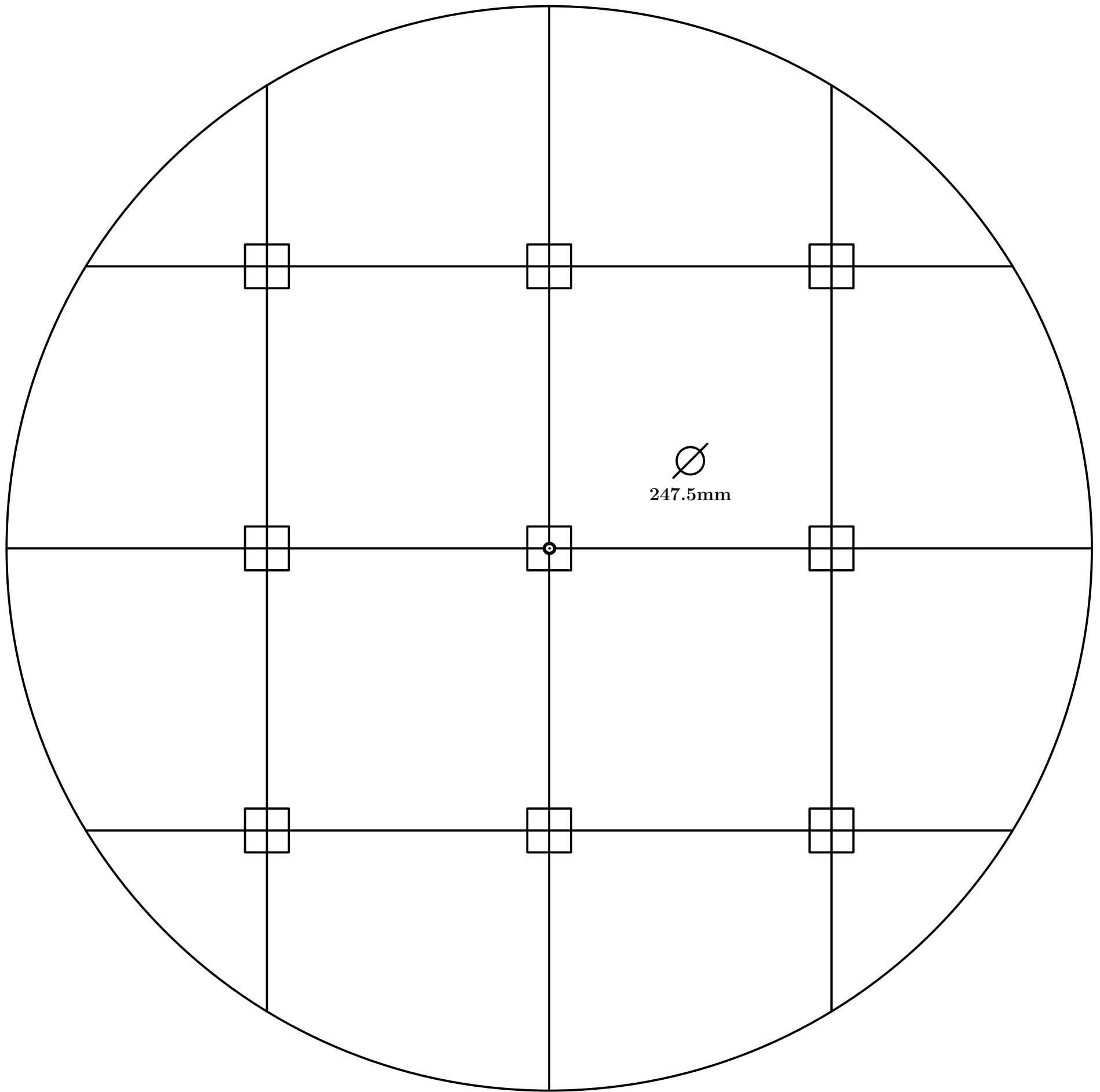

Fig. 591

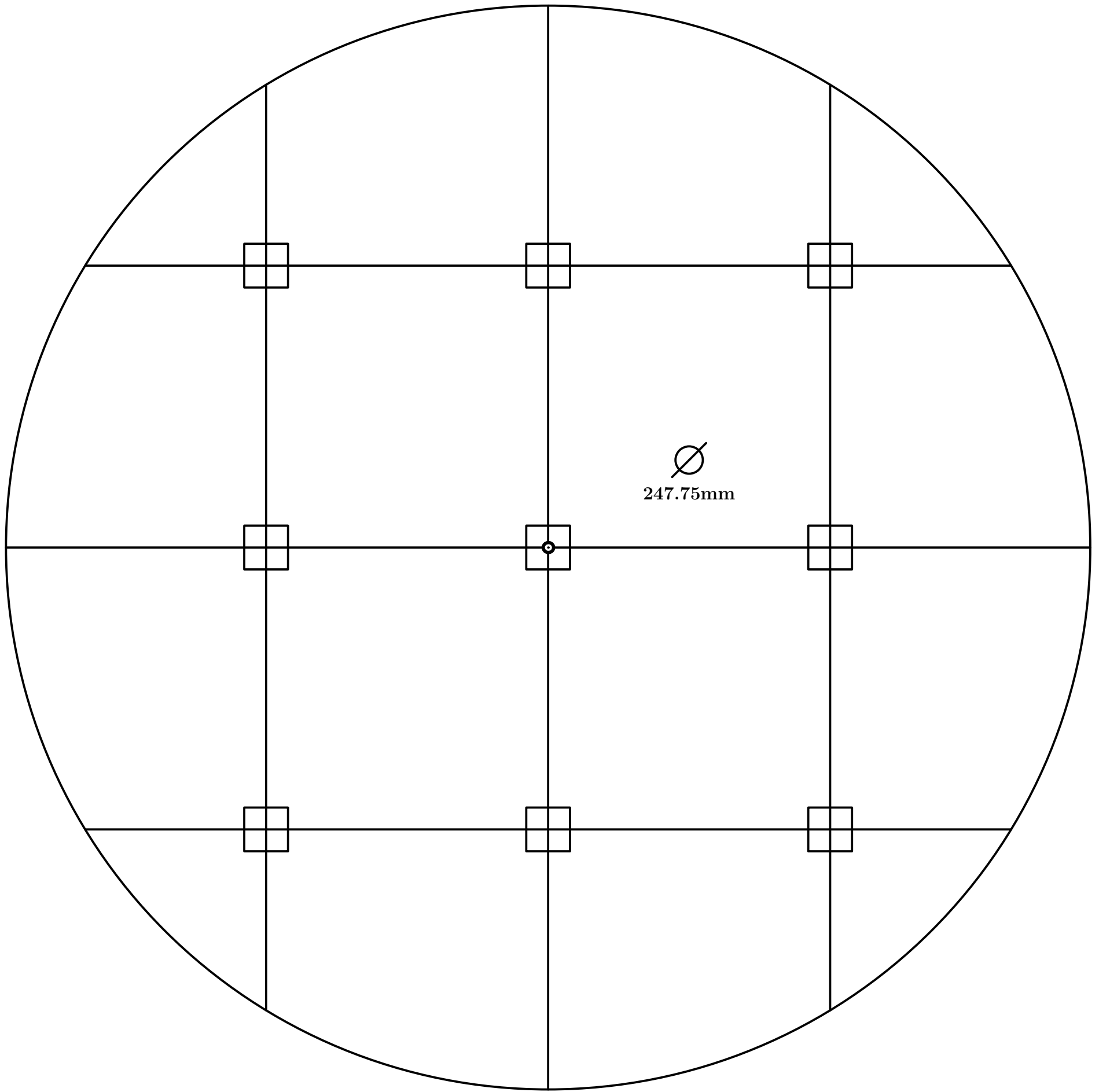

Fig. 592

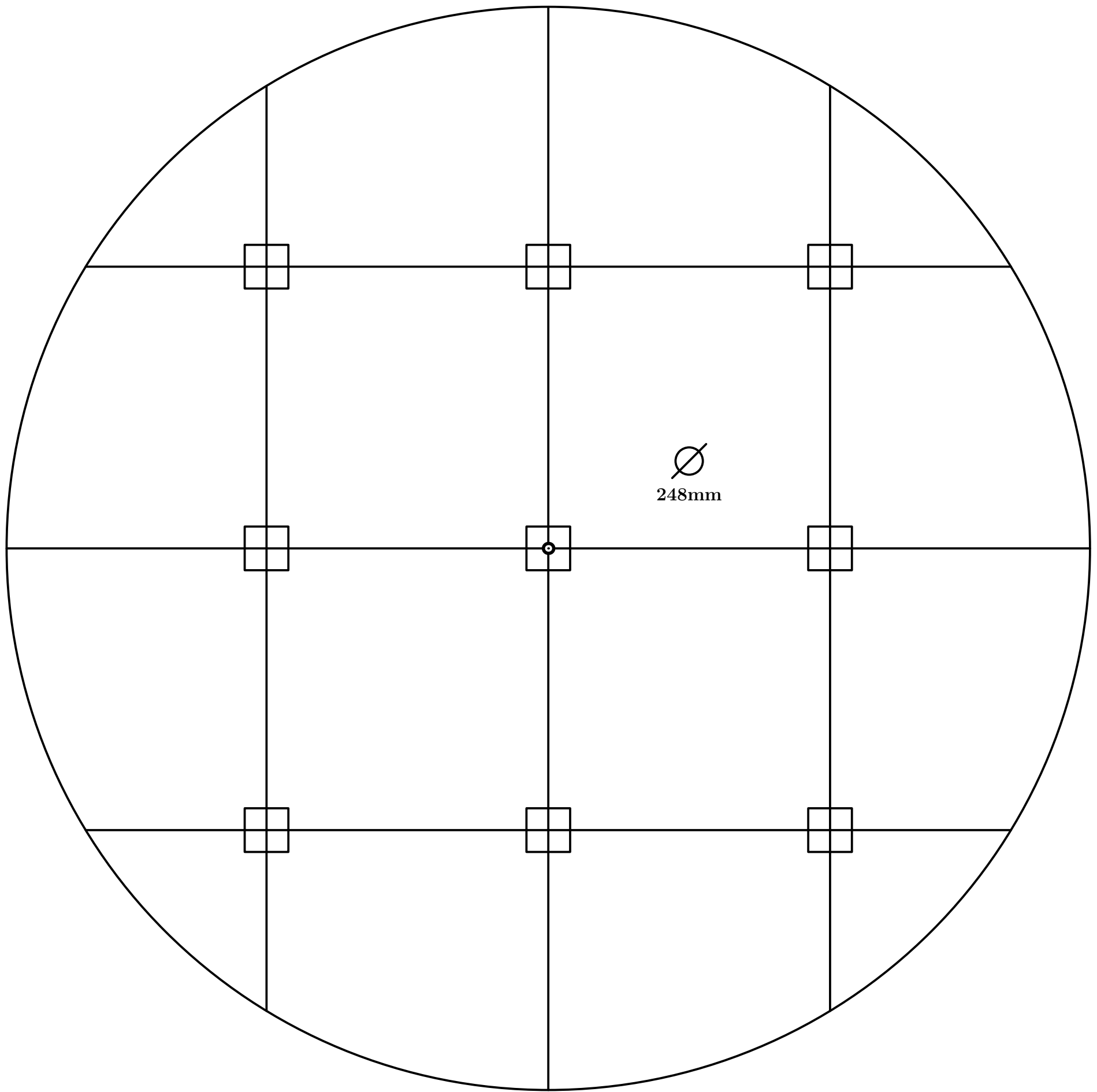

Fig. 593

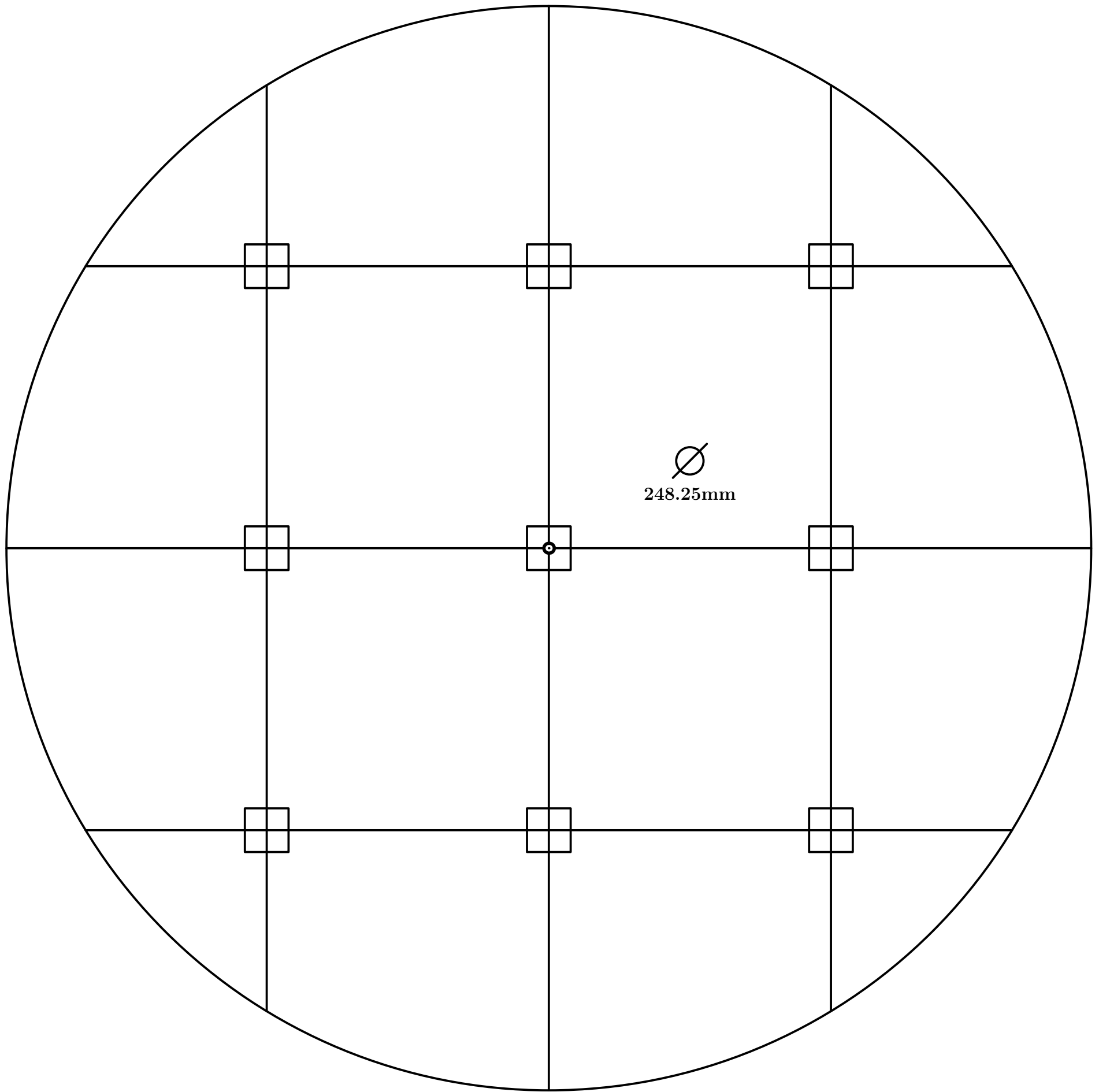

Fig. 594

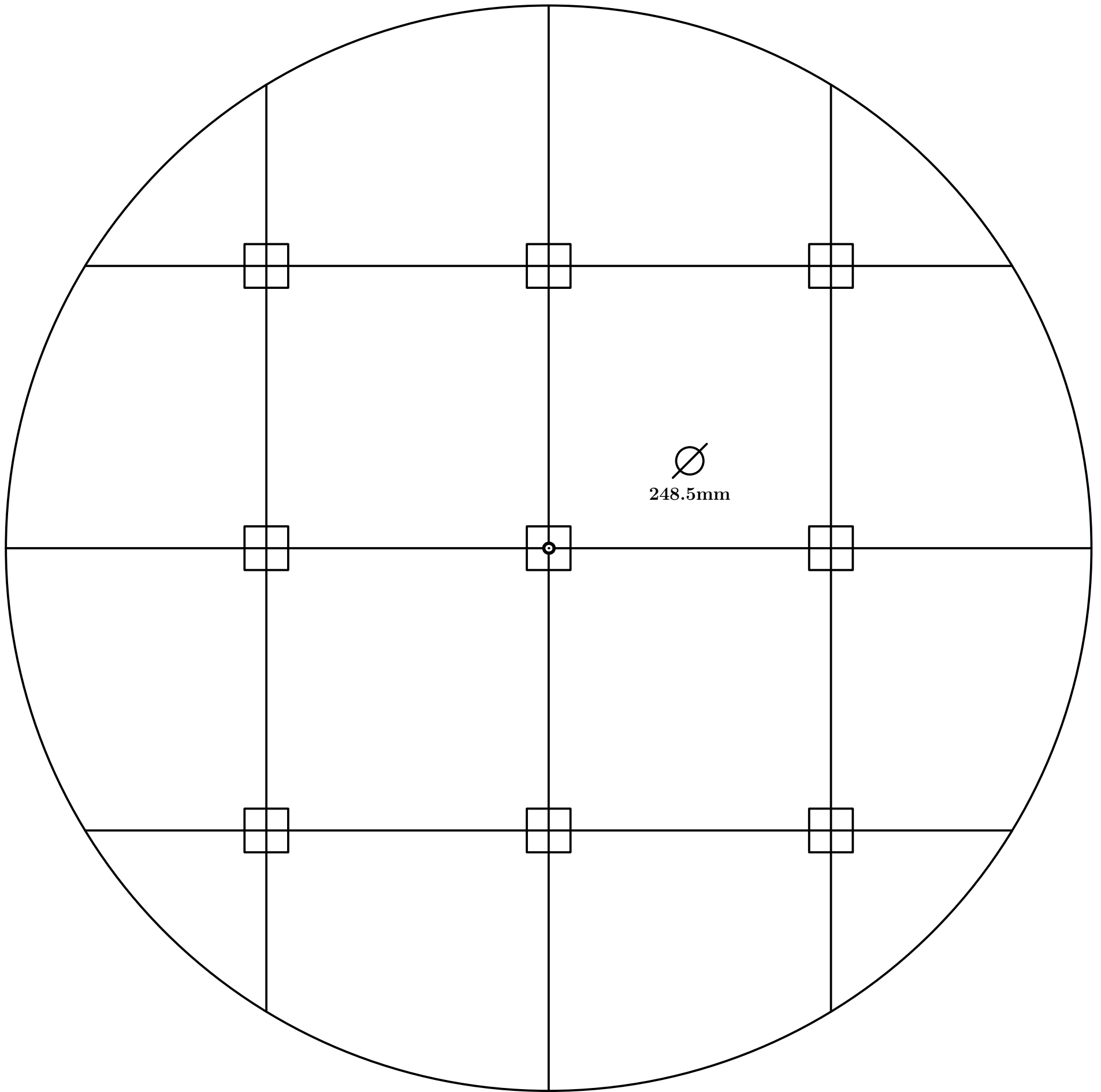

Fig. 595

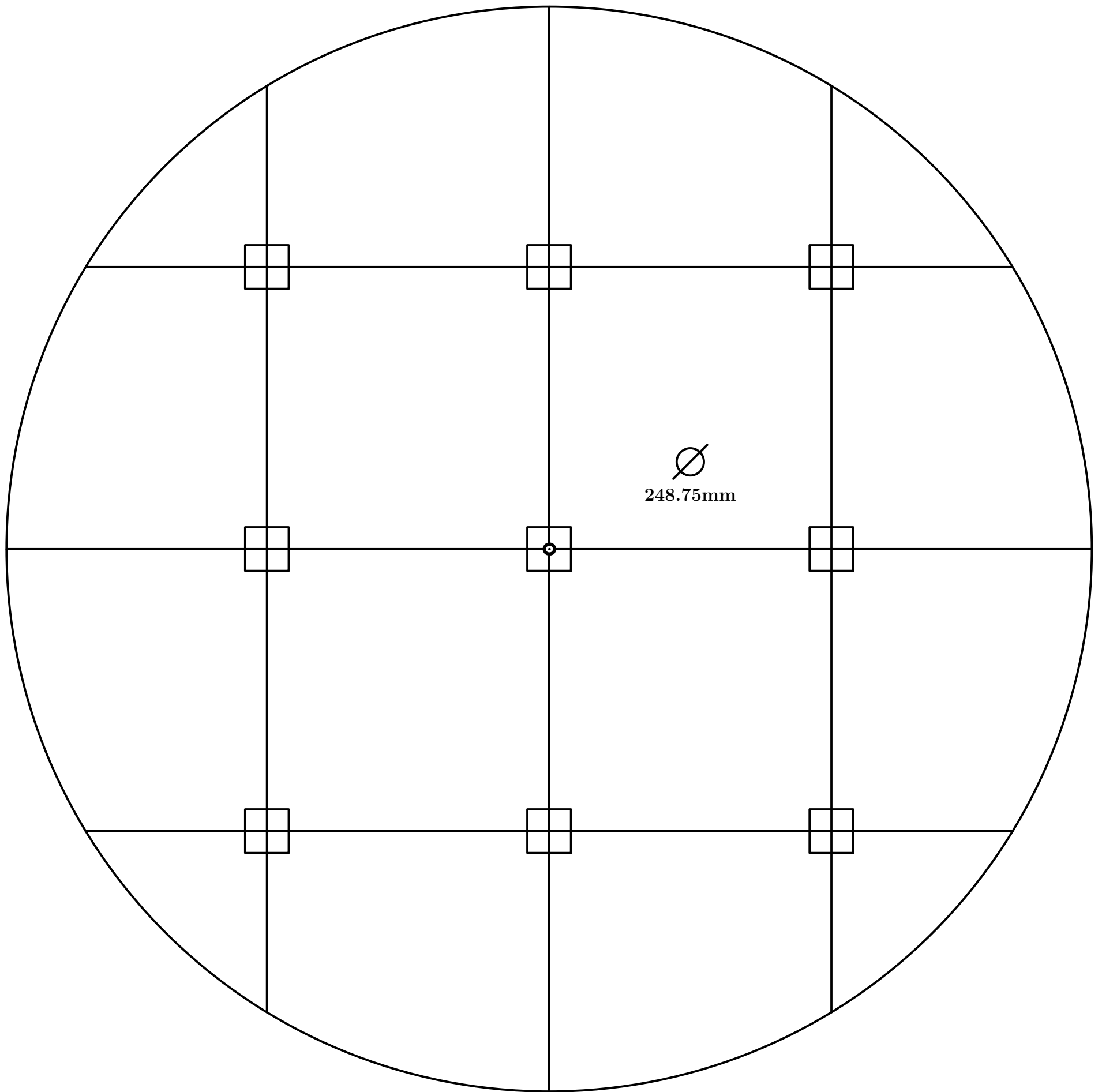

Fig. 596

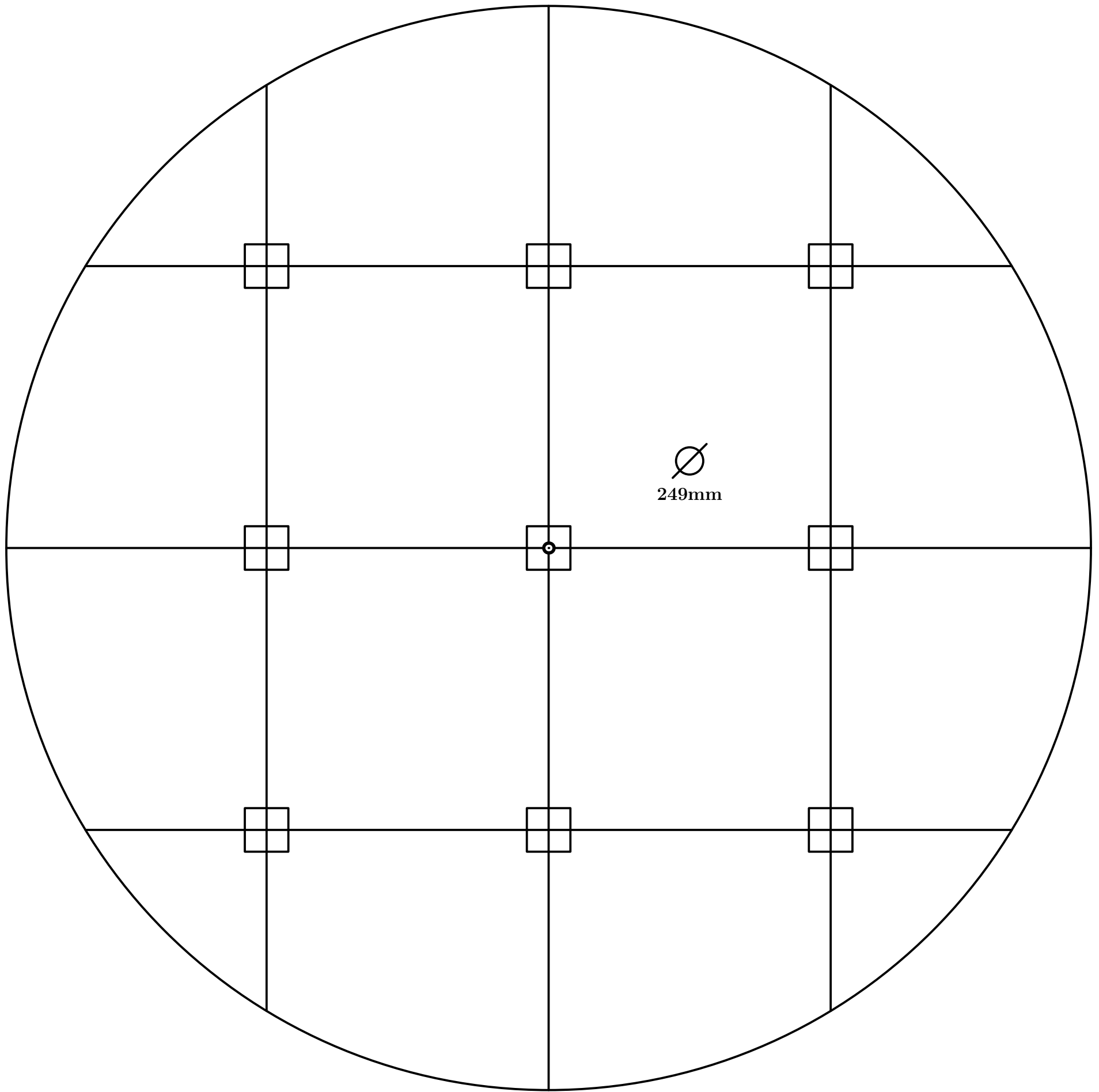

Fig. 597

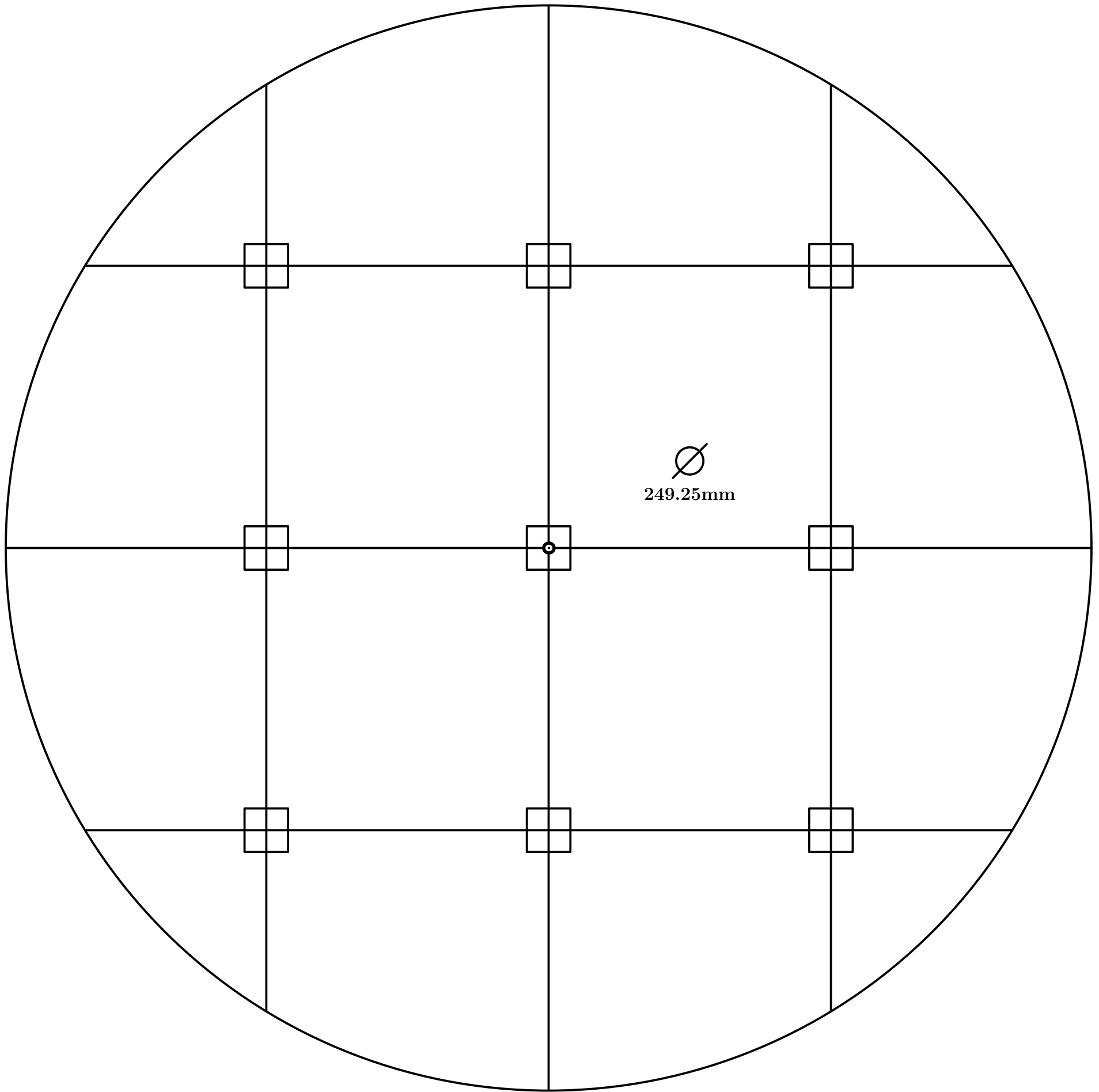

Fig. 598

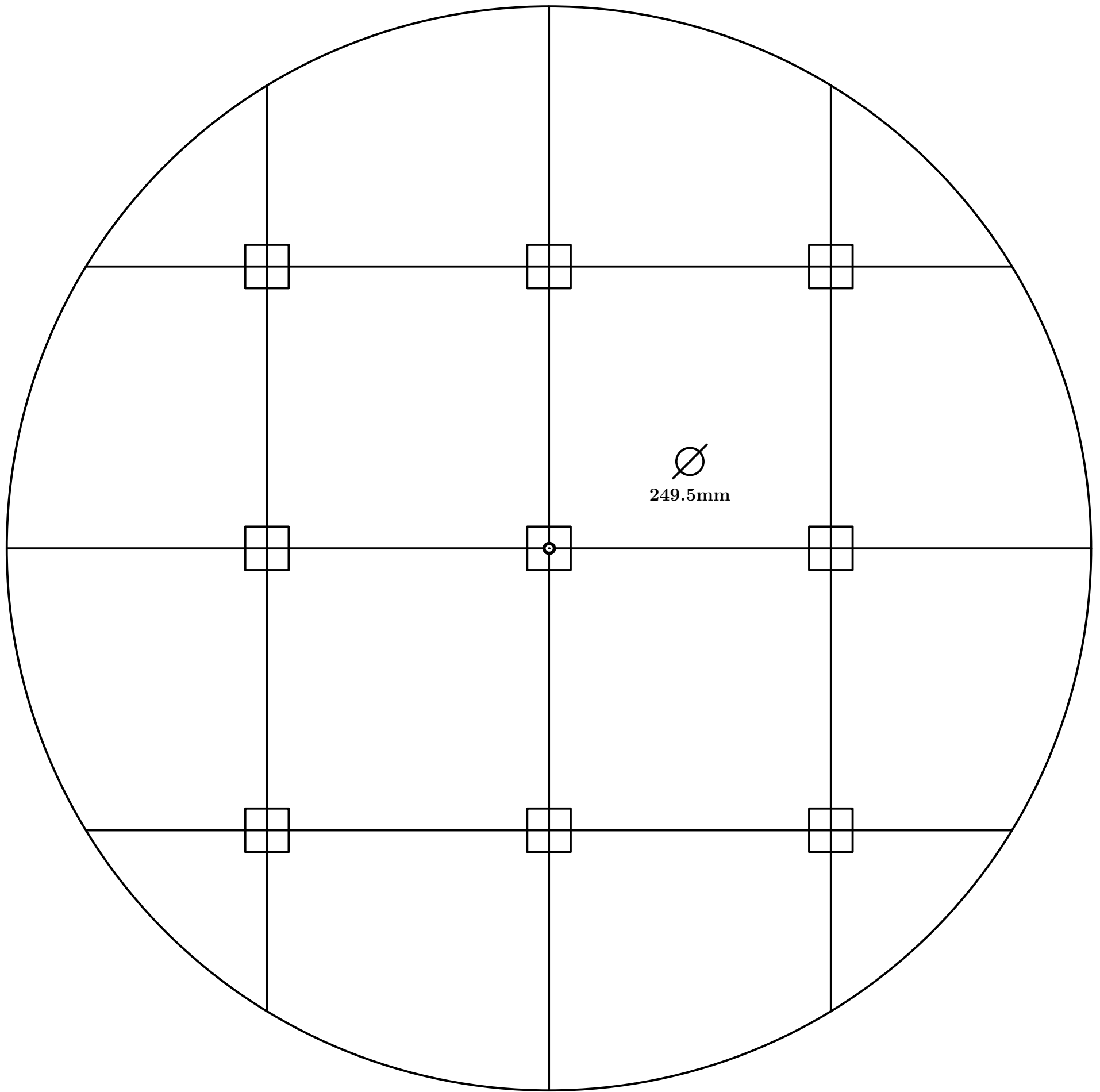

Fig. 599

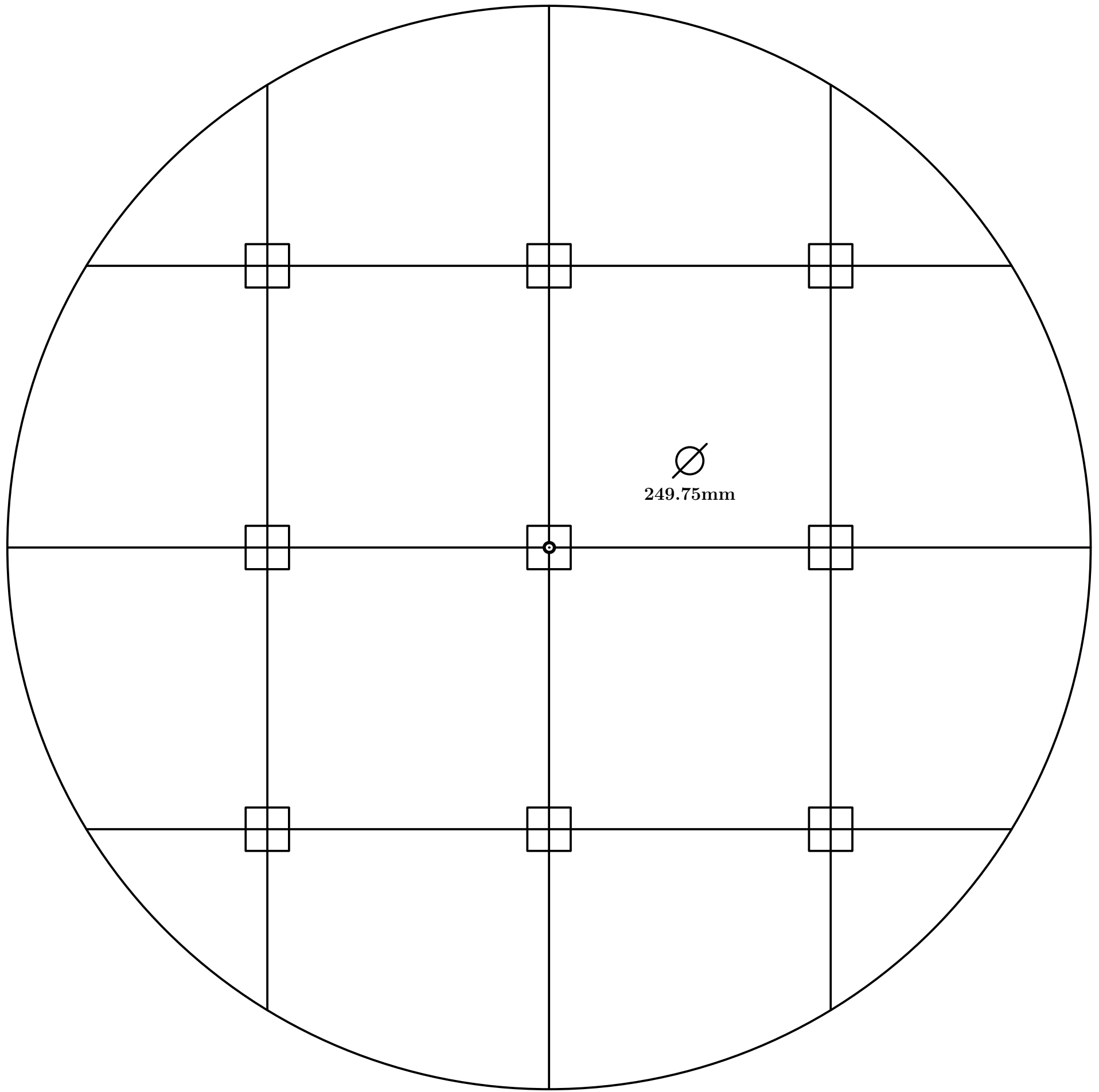

Fig. 600

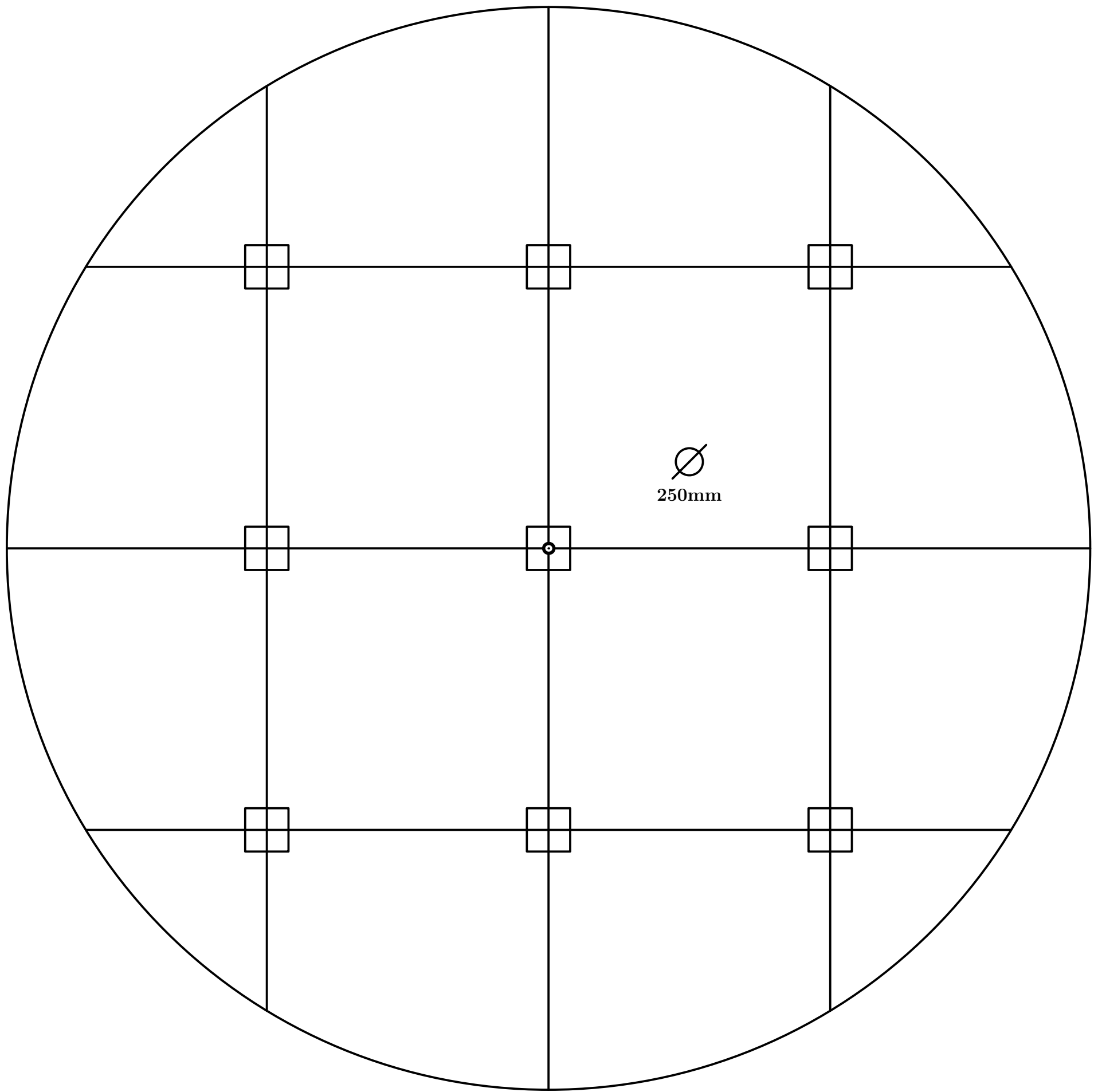

Fig. 601

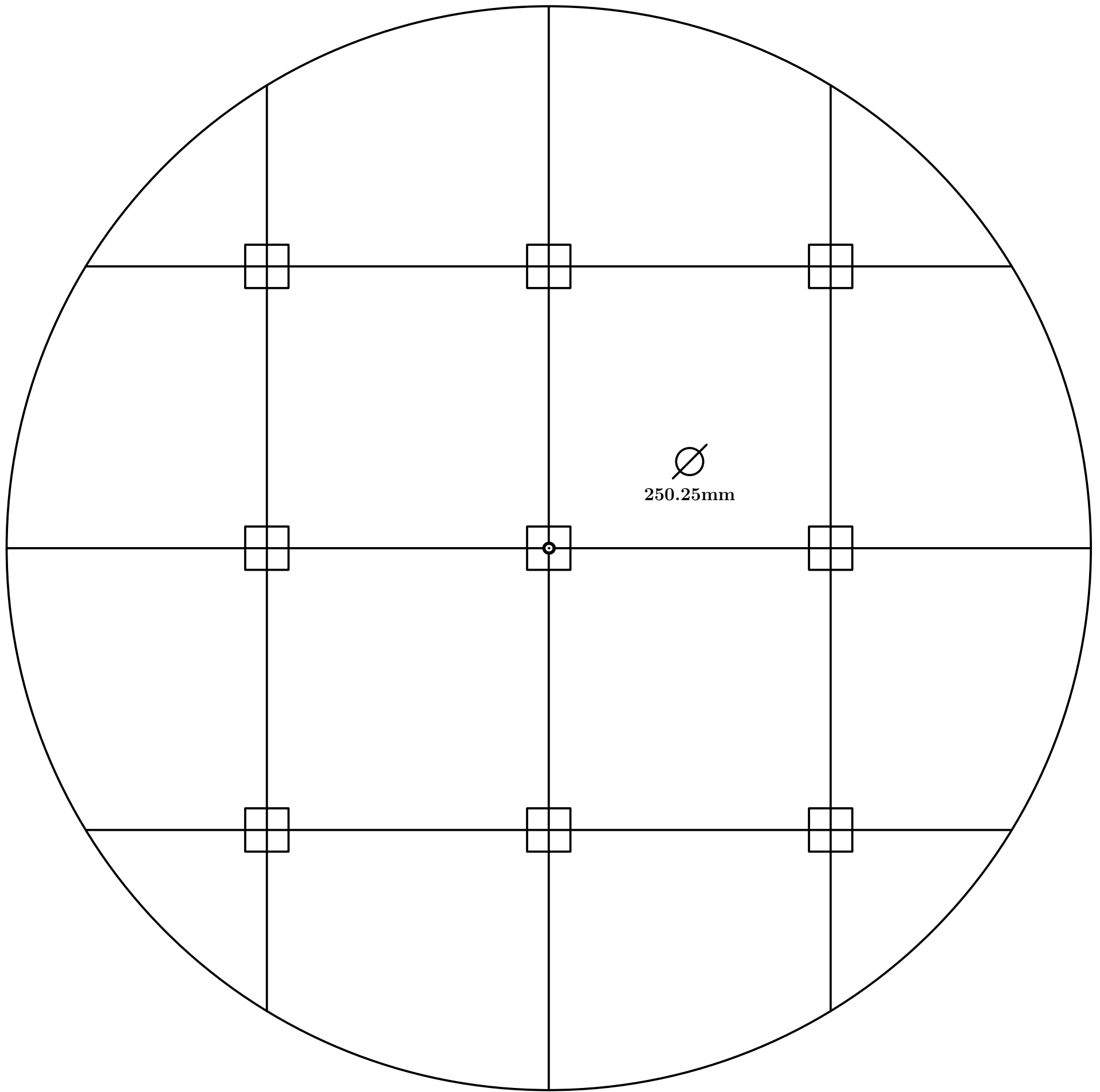

Fig. 602

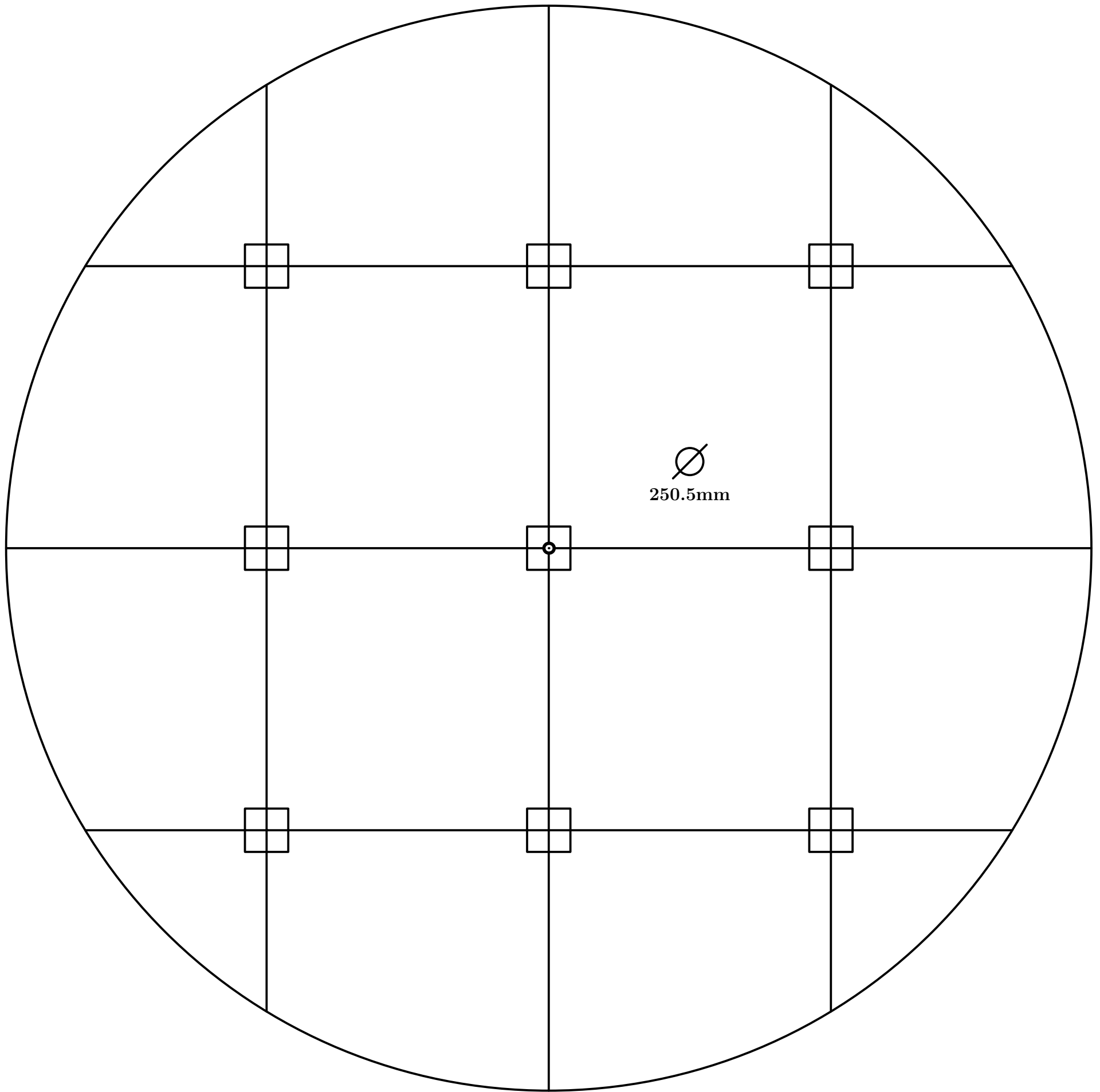

Fig. 603

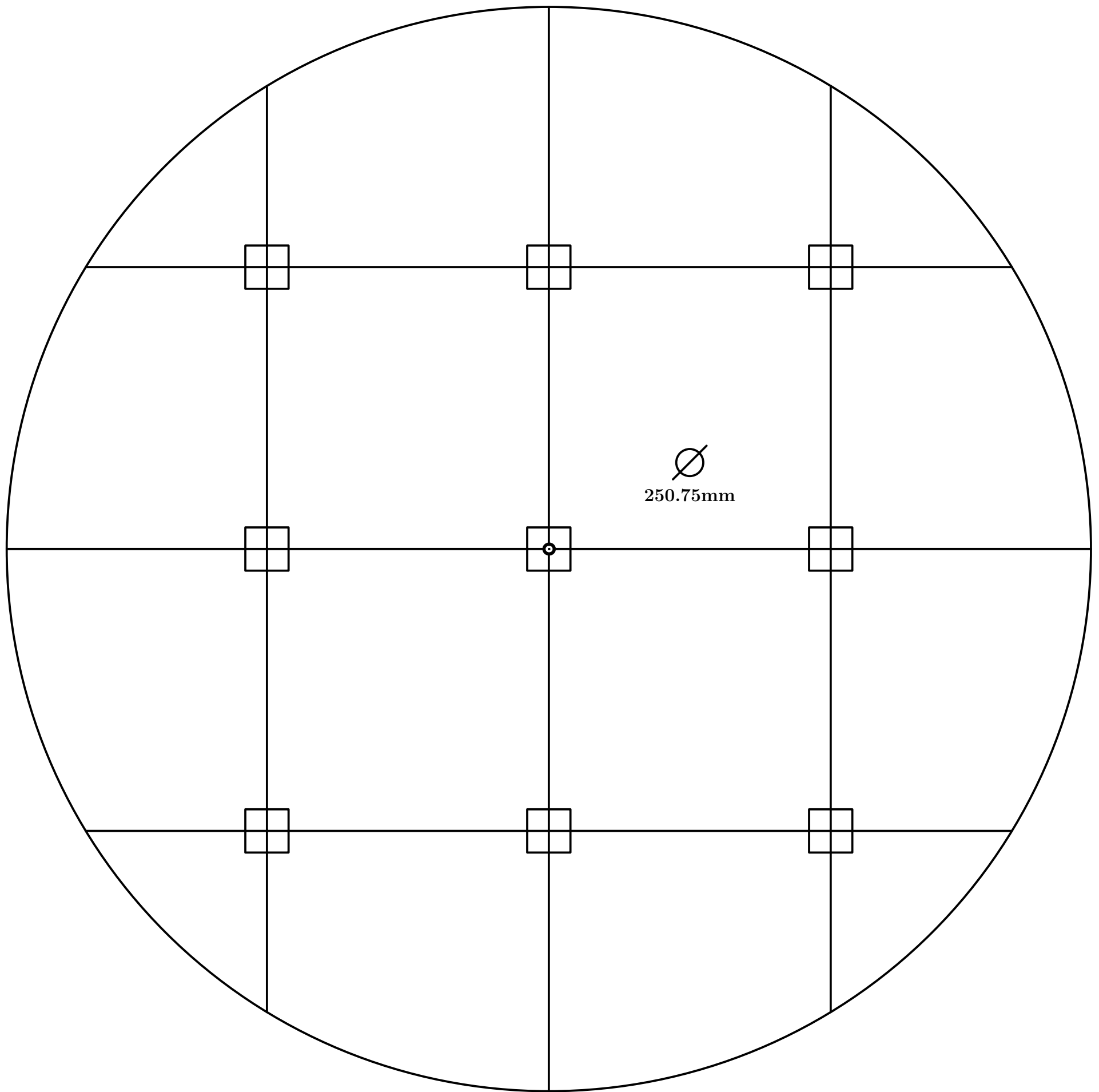

Fig. 604

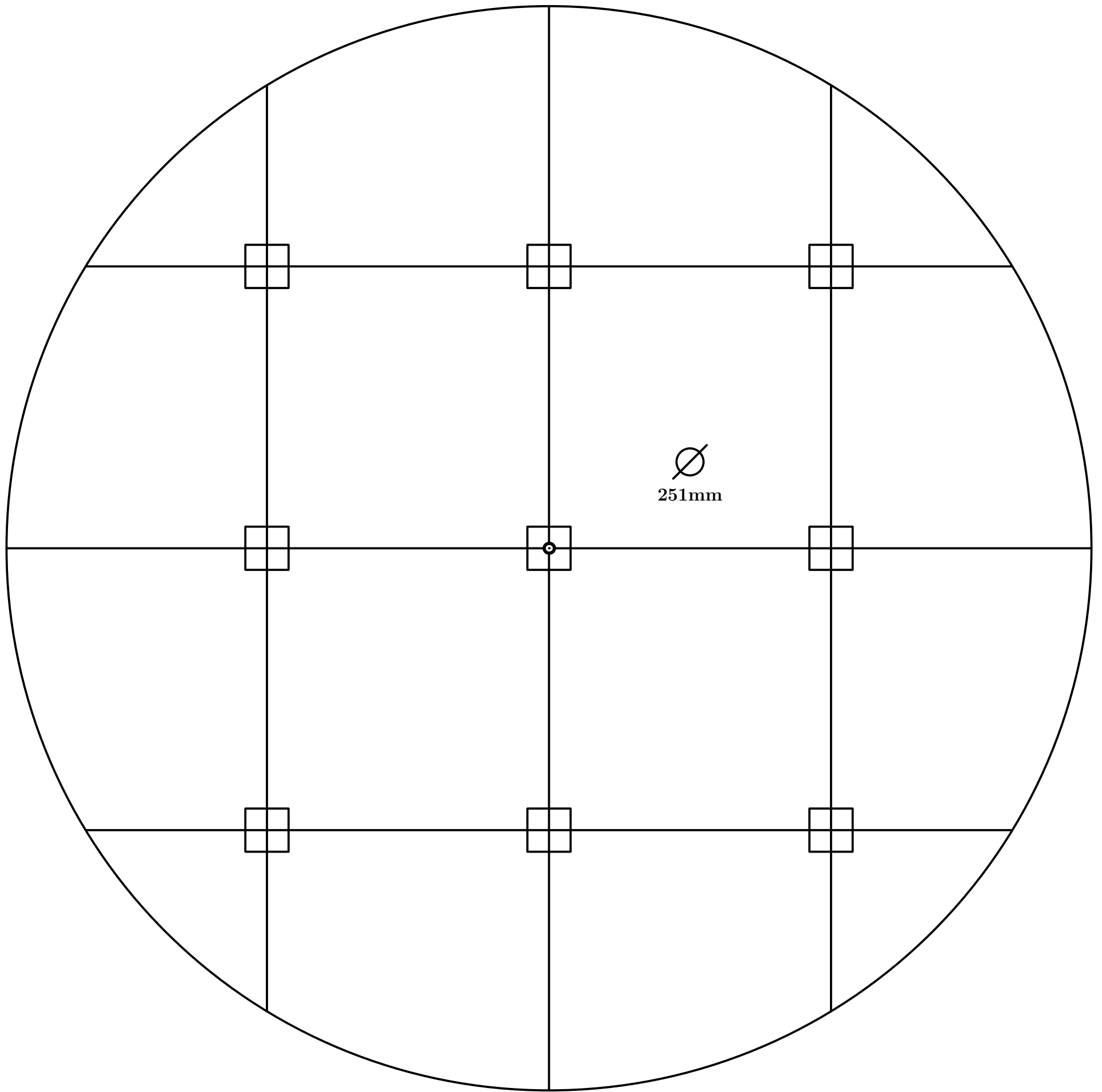

Fig. 605

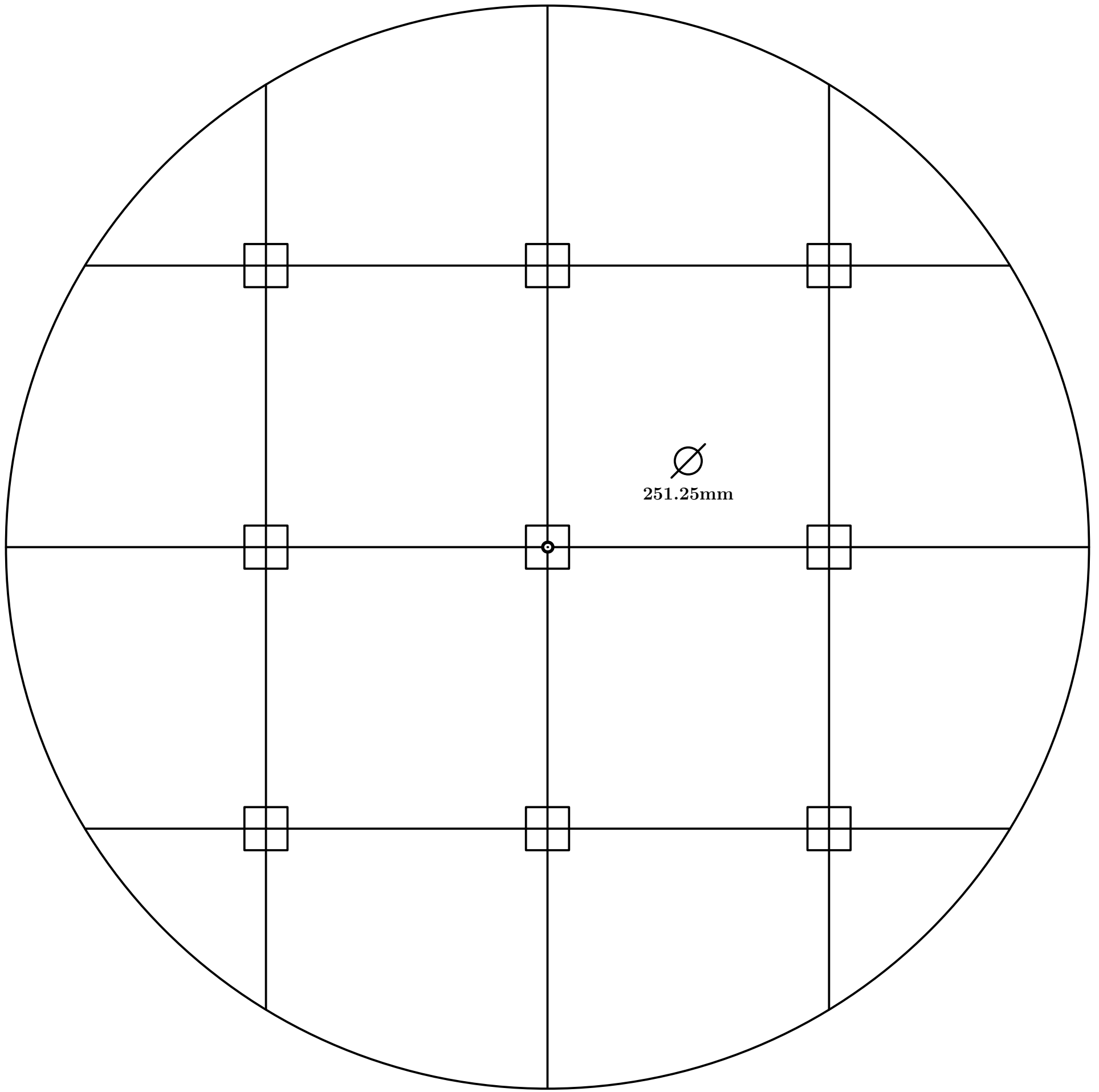

Fig. 606

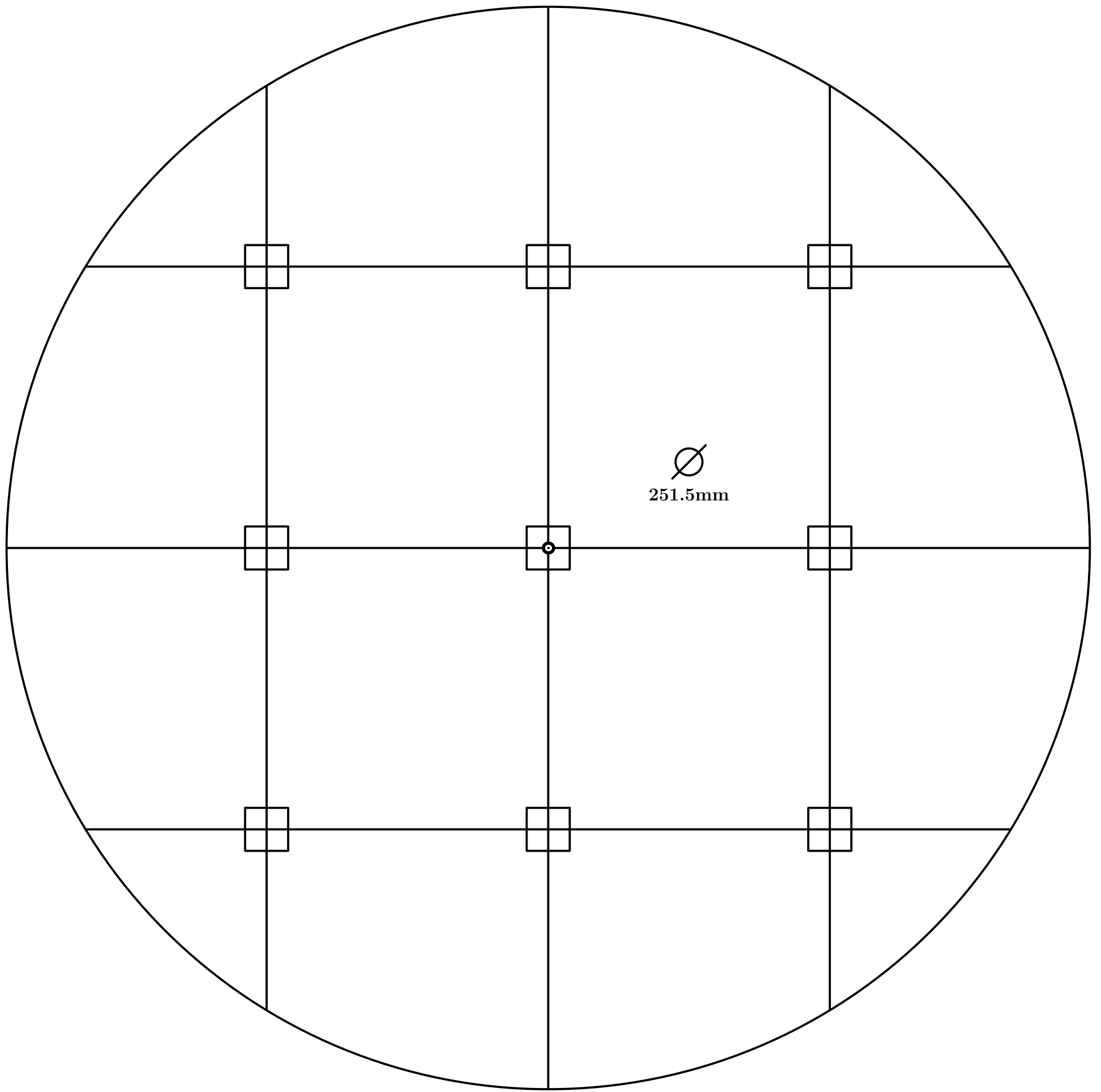

Fig. 607

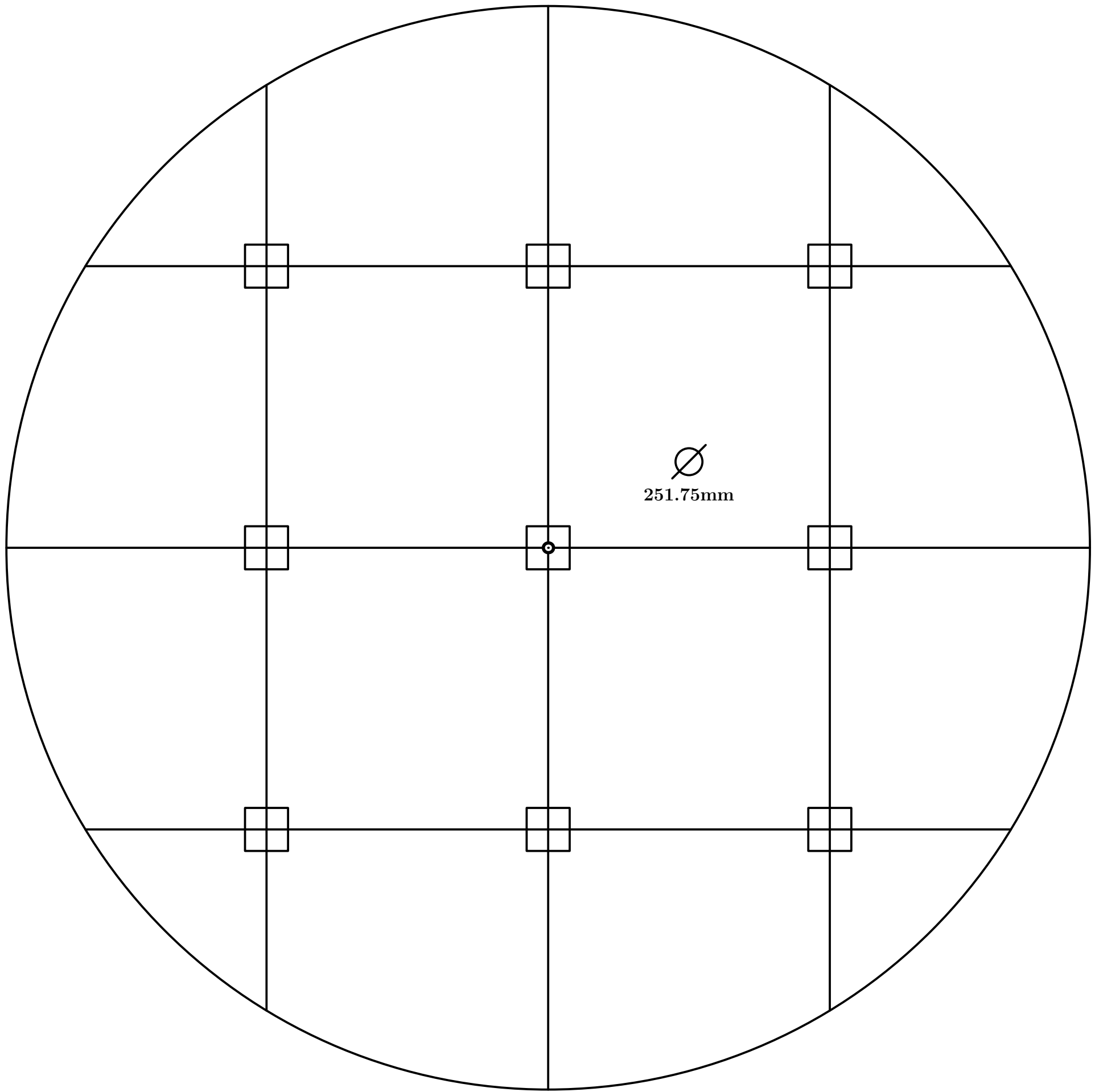

Fig. 608

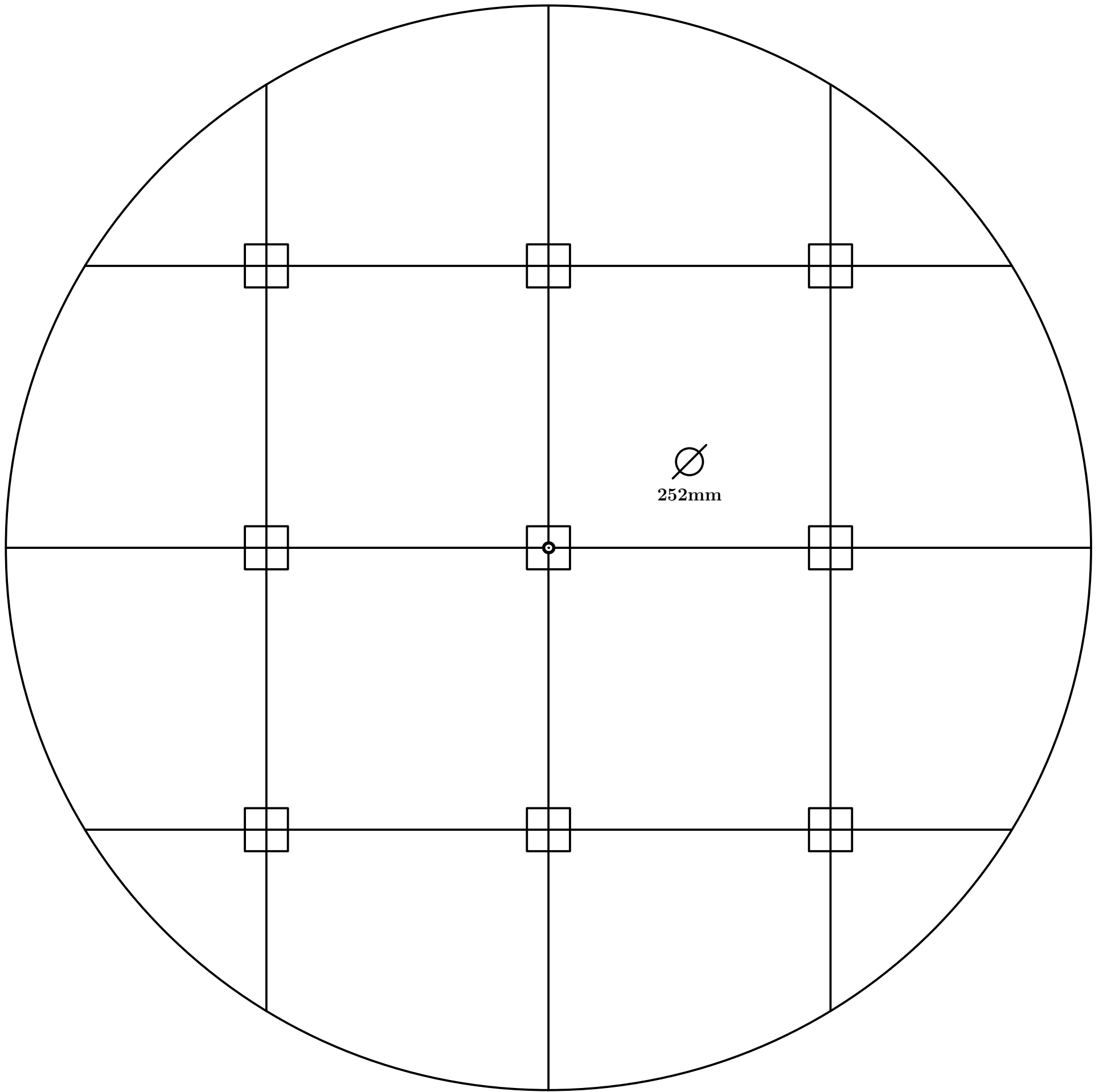

Fig. 609

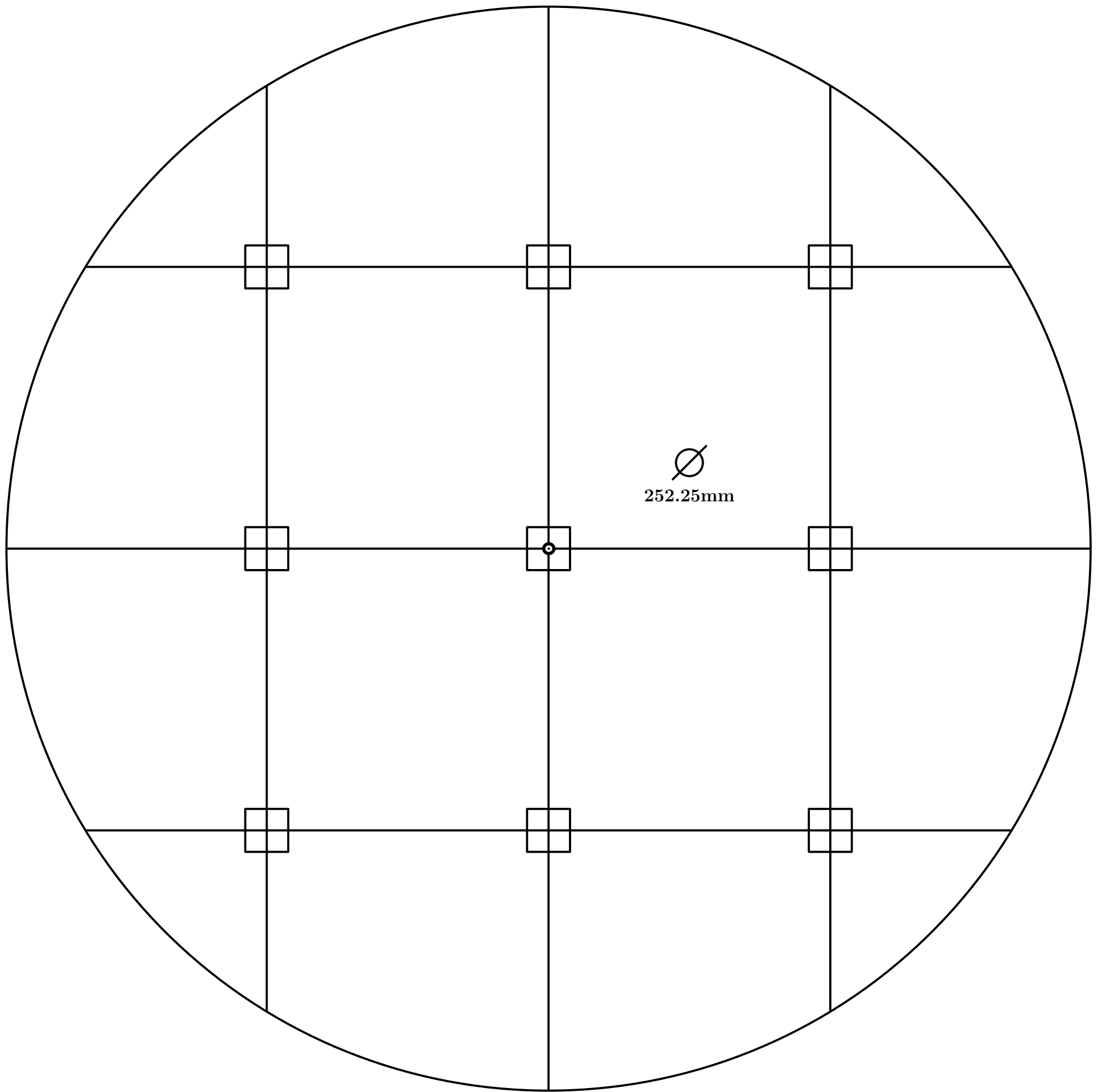

Fig. 610

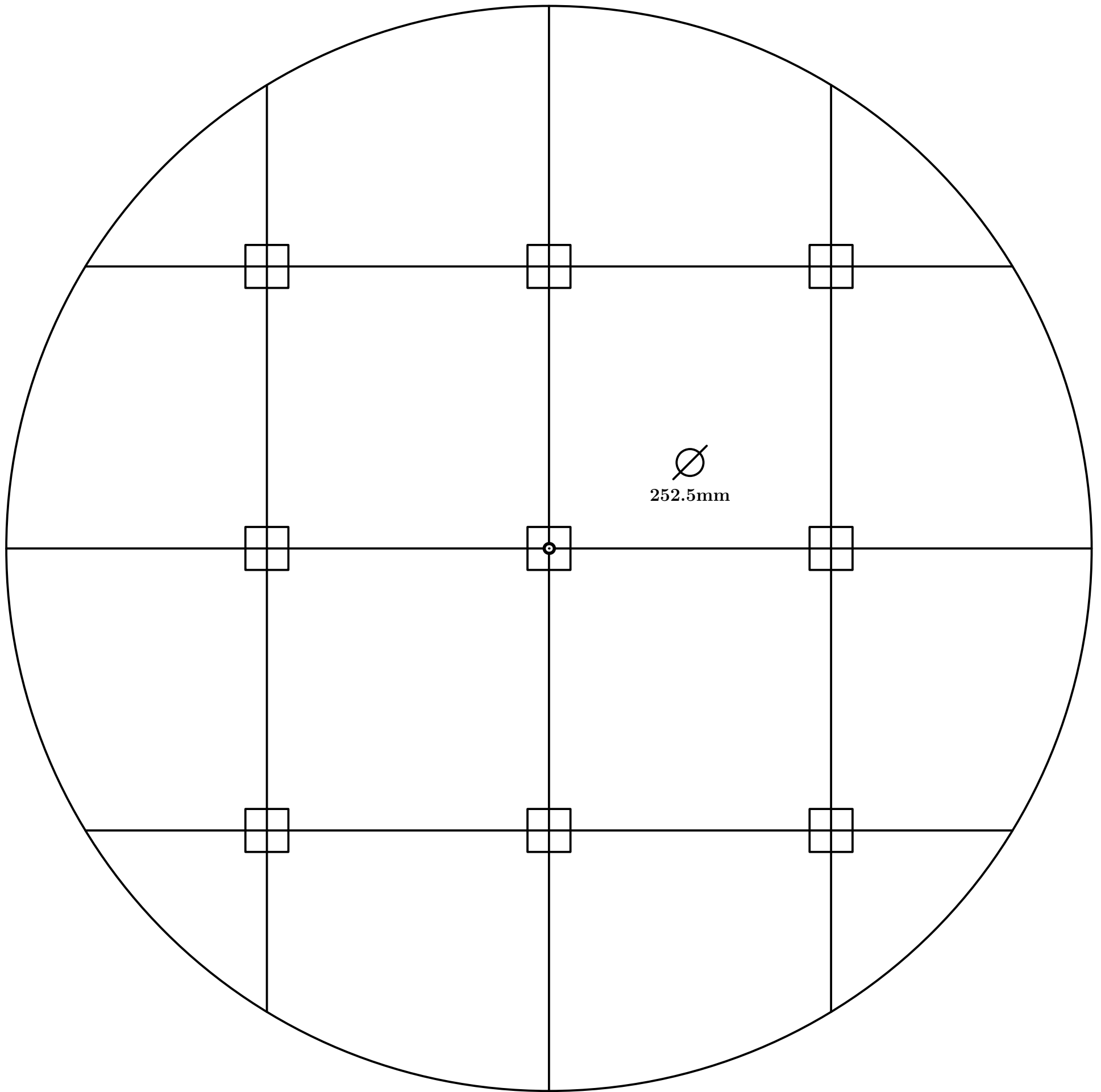

Fig. 611

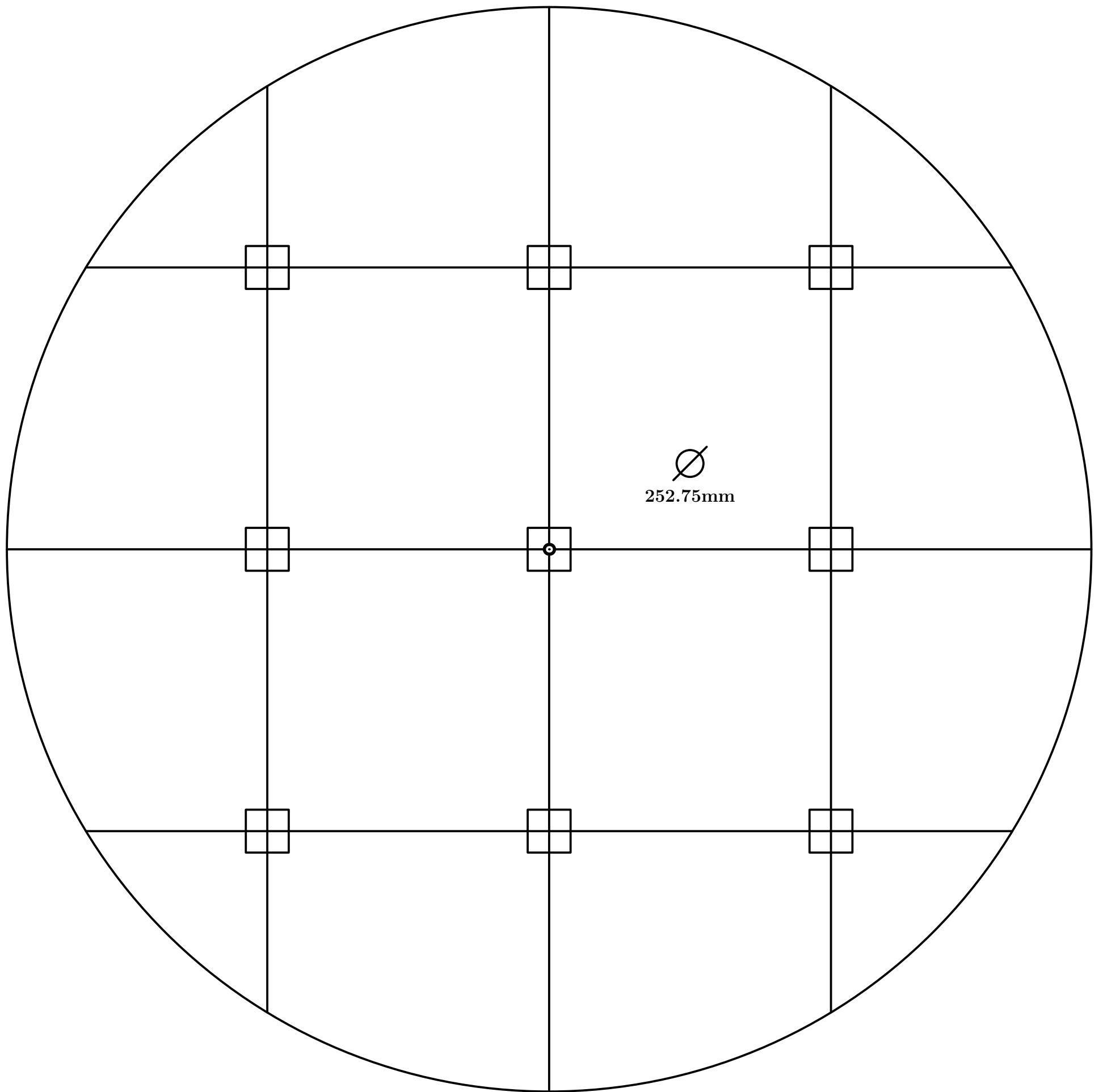

Fig. 612

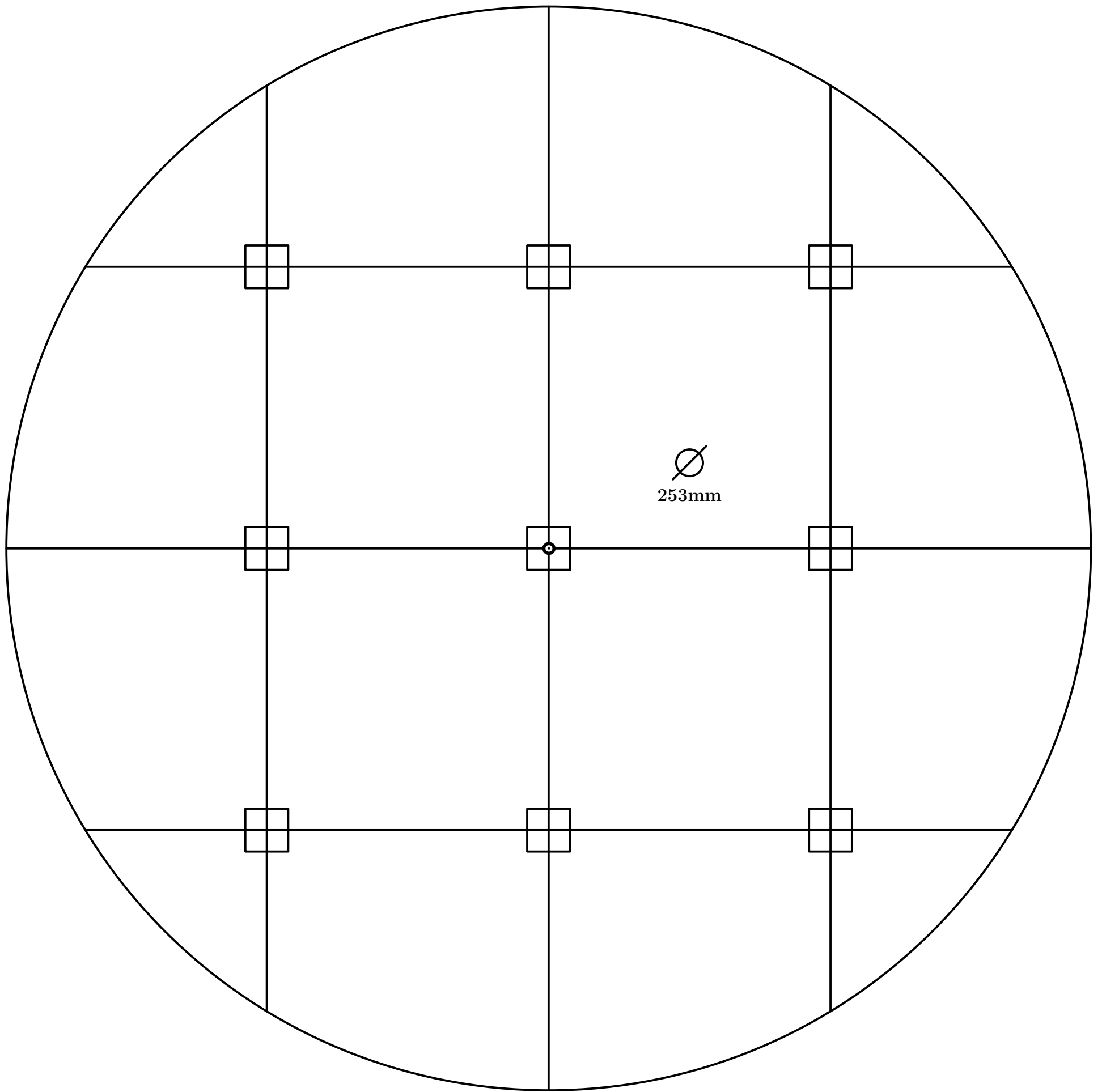

Fig. 613

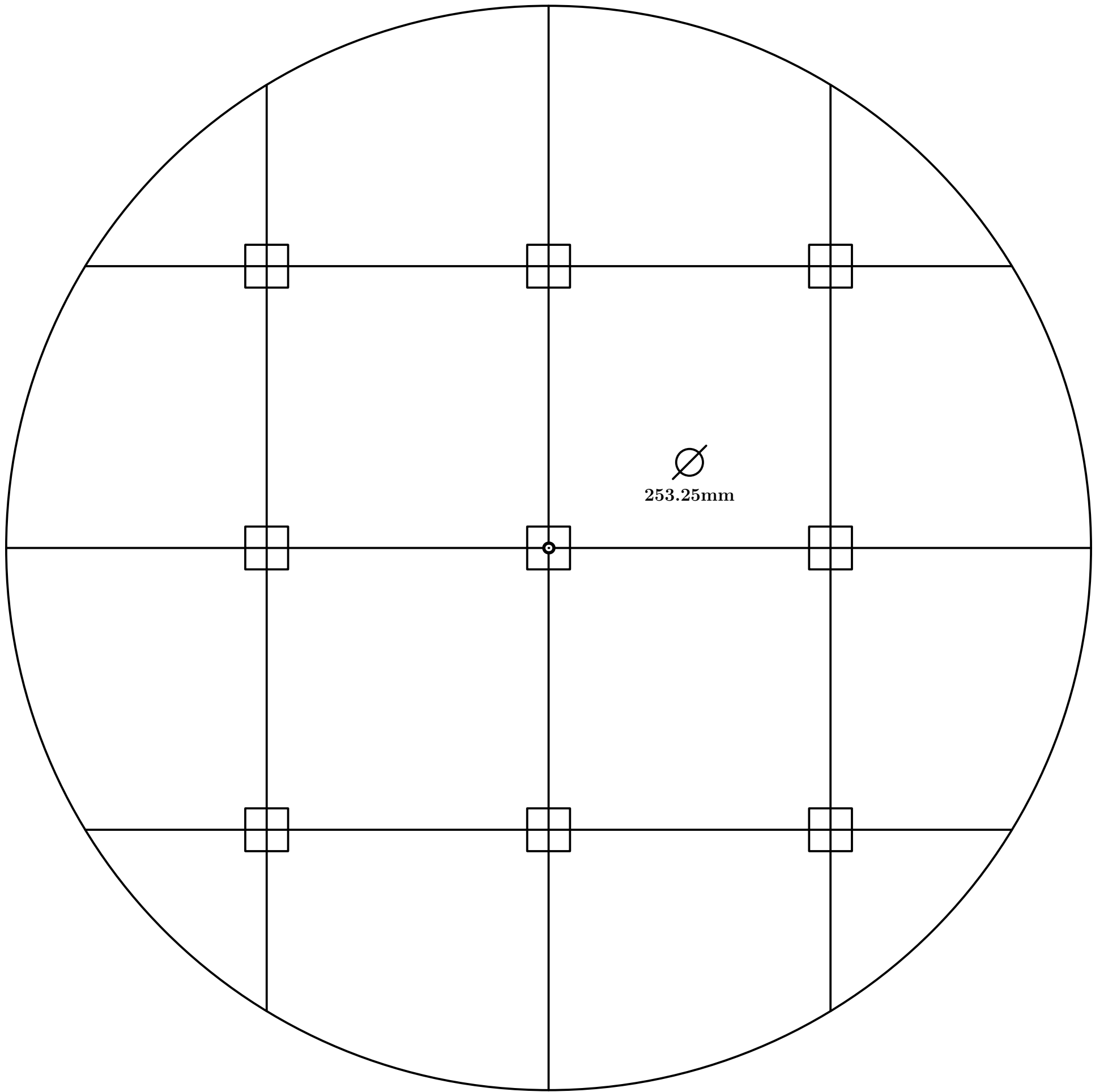

Fig. 614

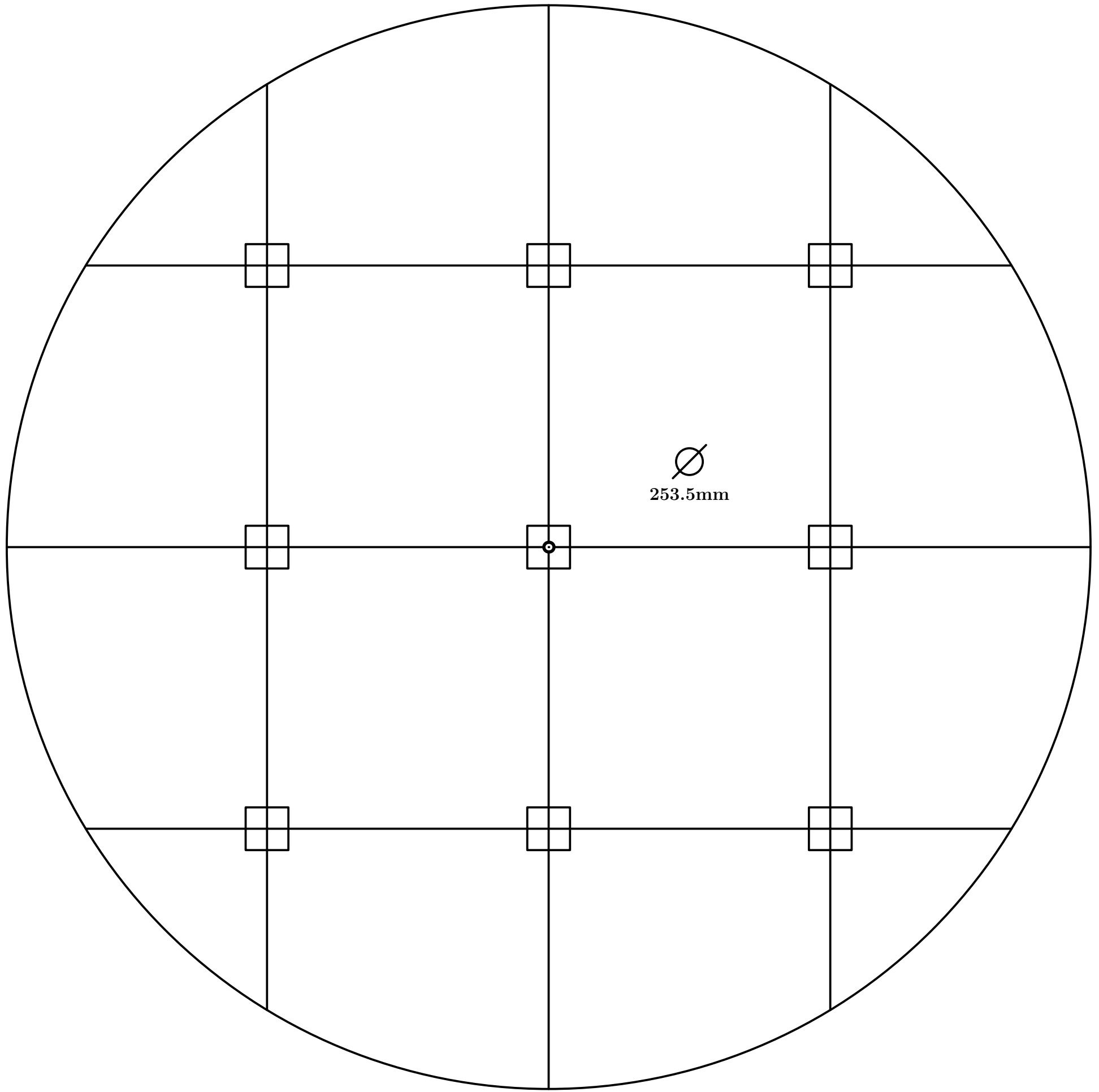

Fig. 615

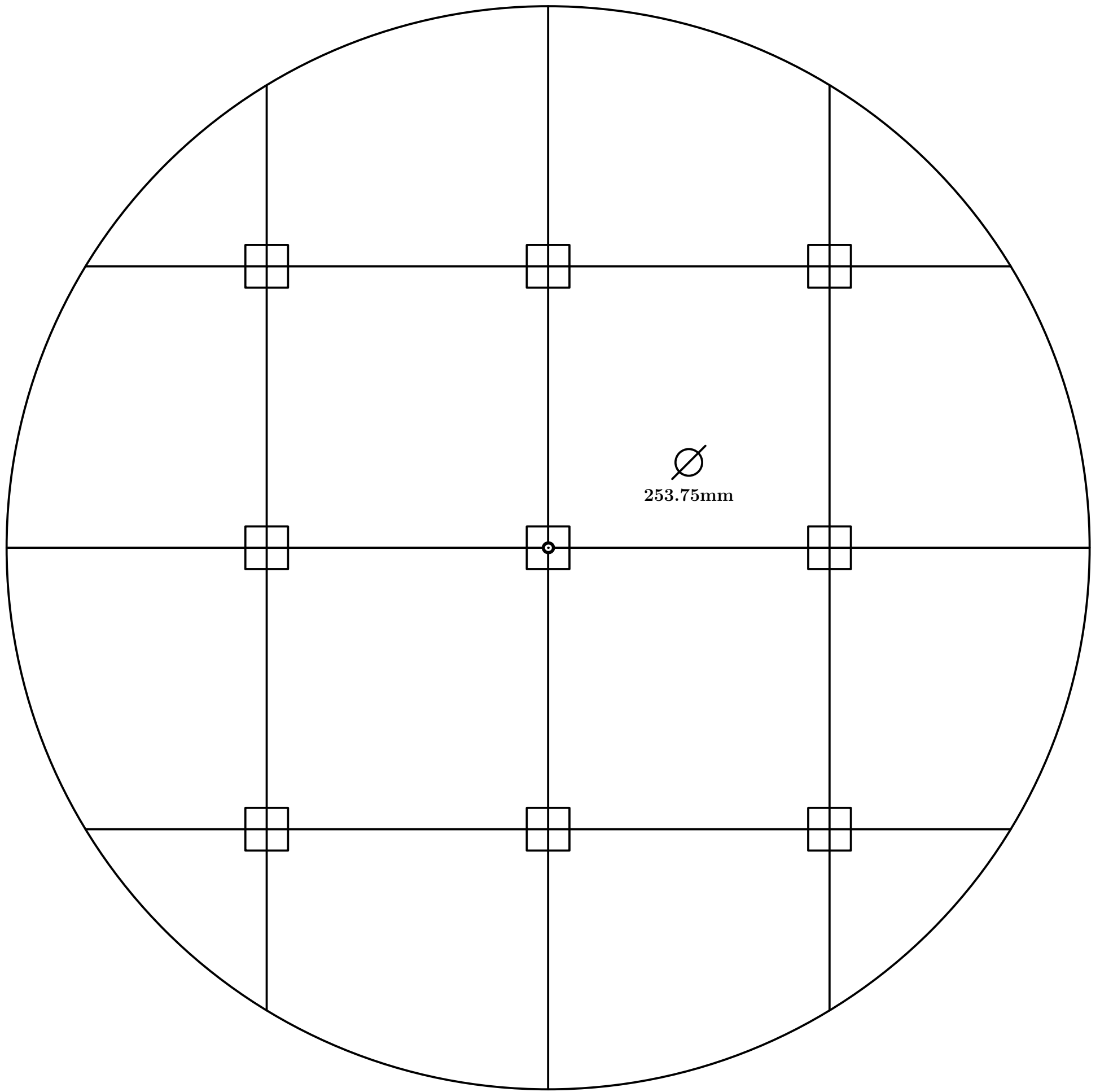

Fig. 616

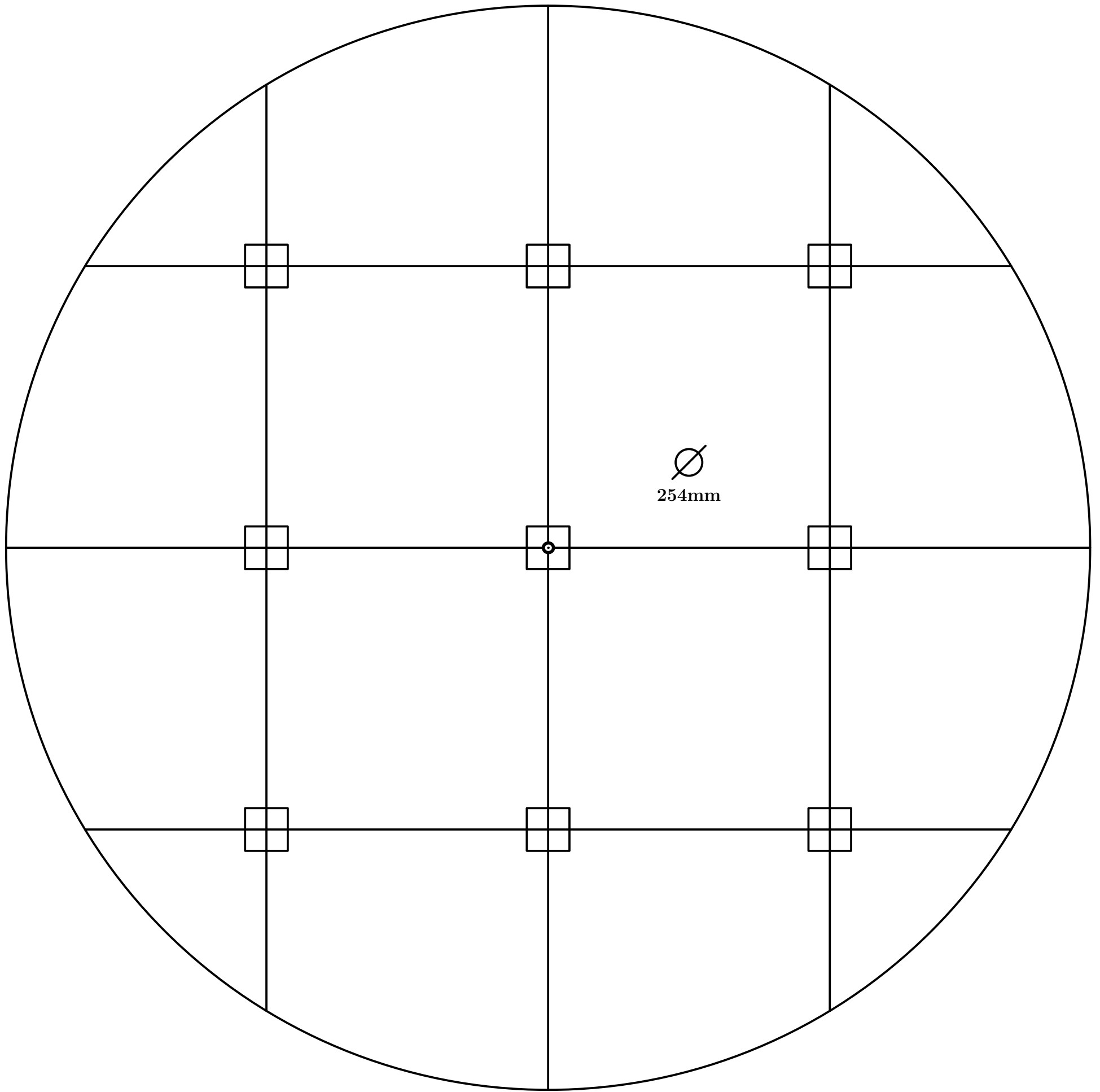

Fig. 617

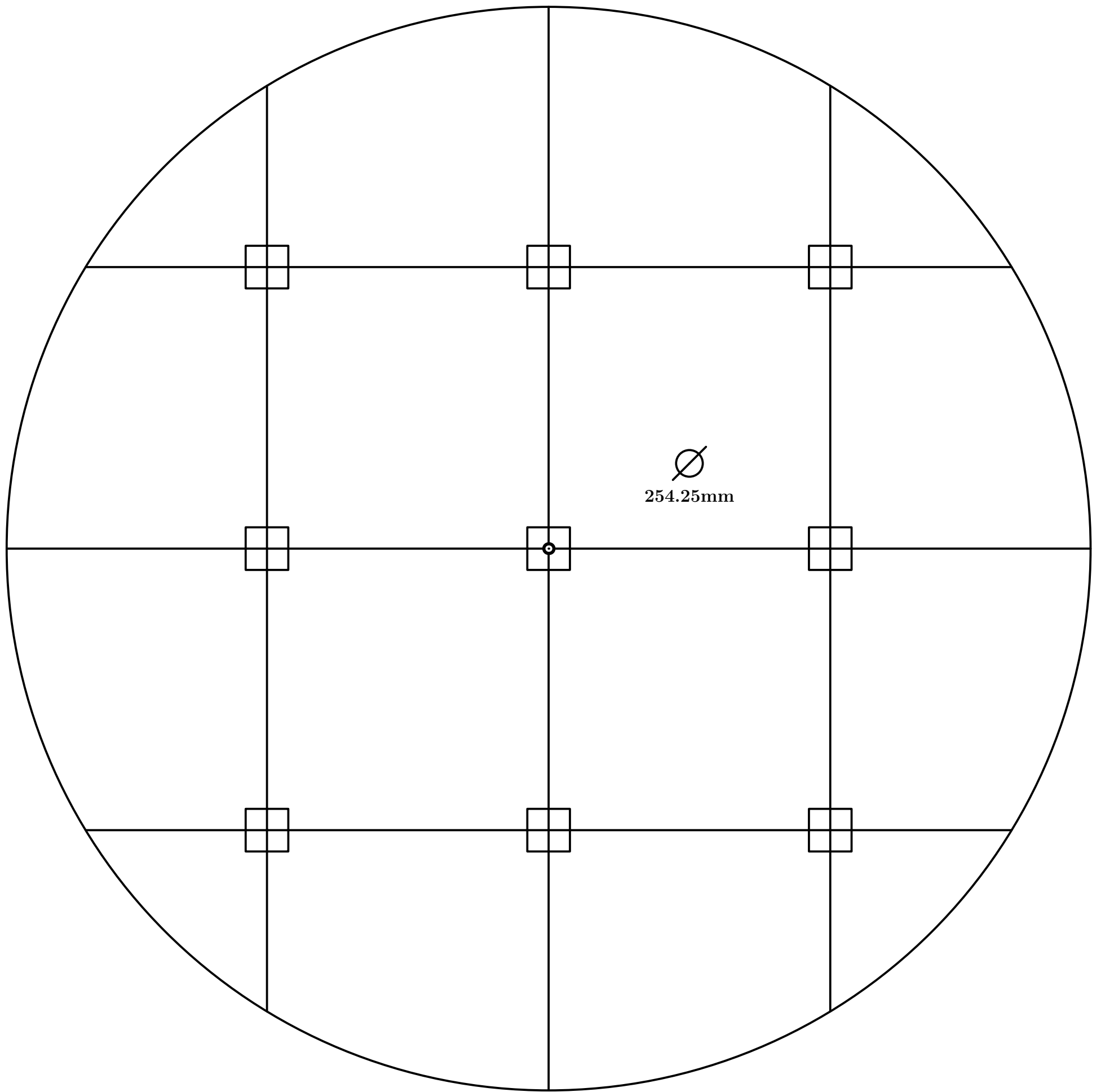

Fig. 618

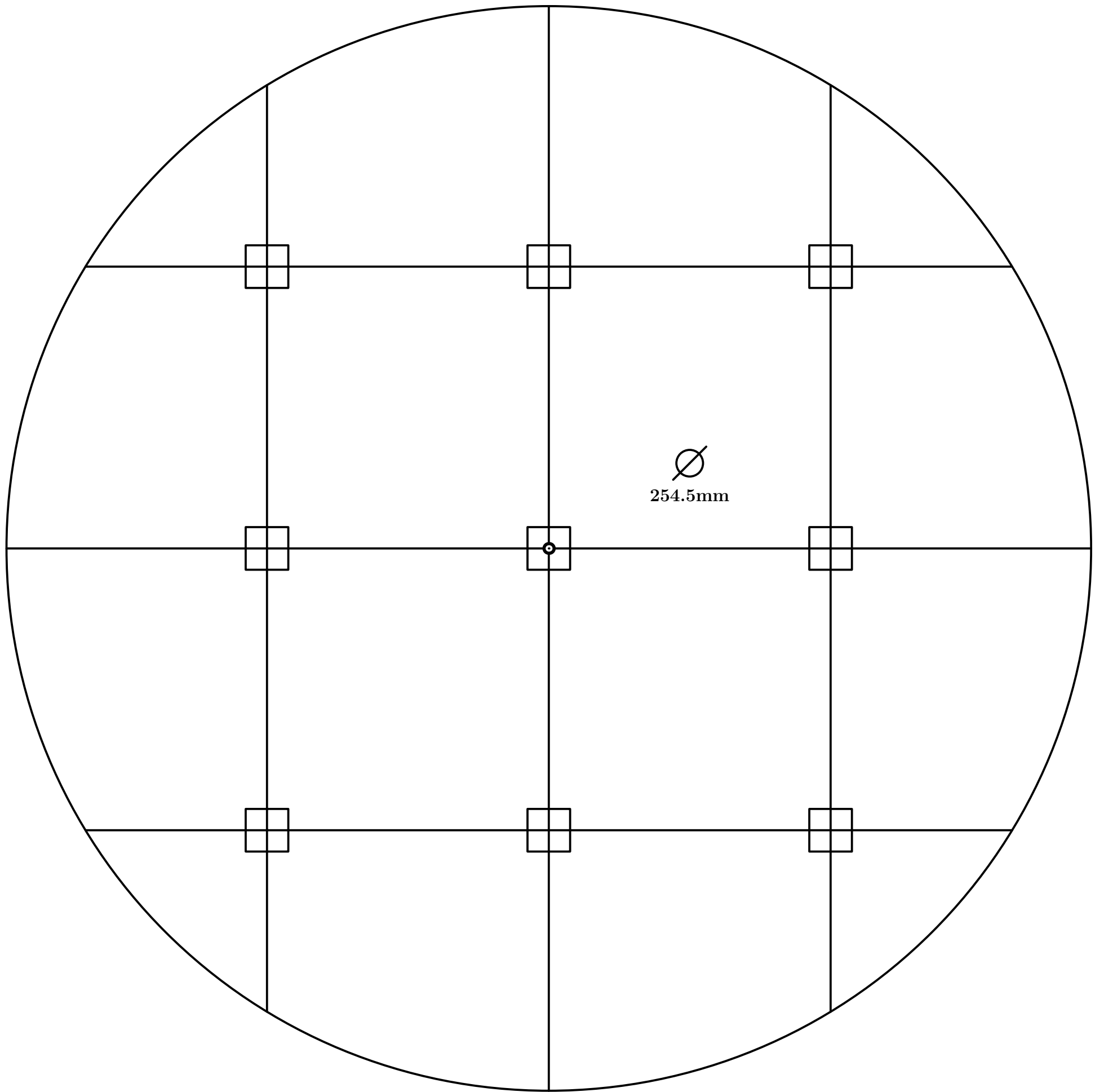

Fig. 619

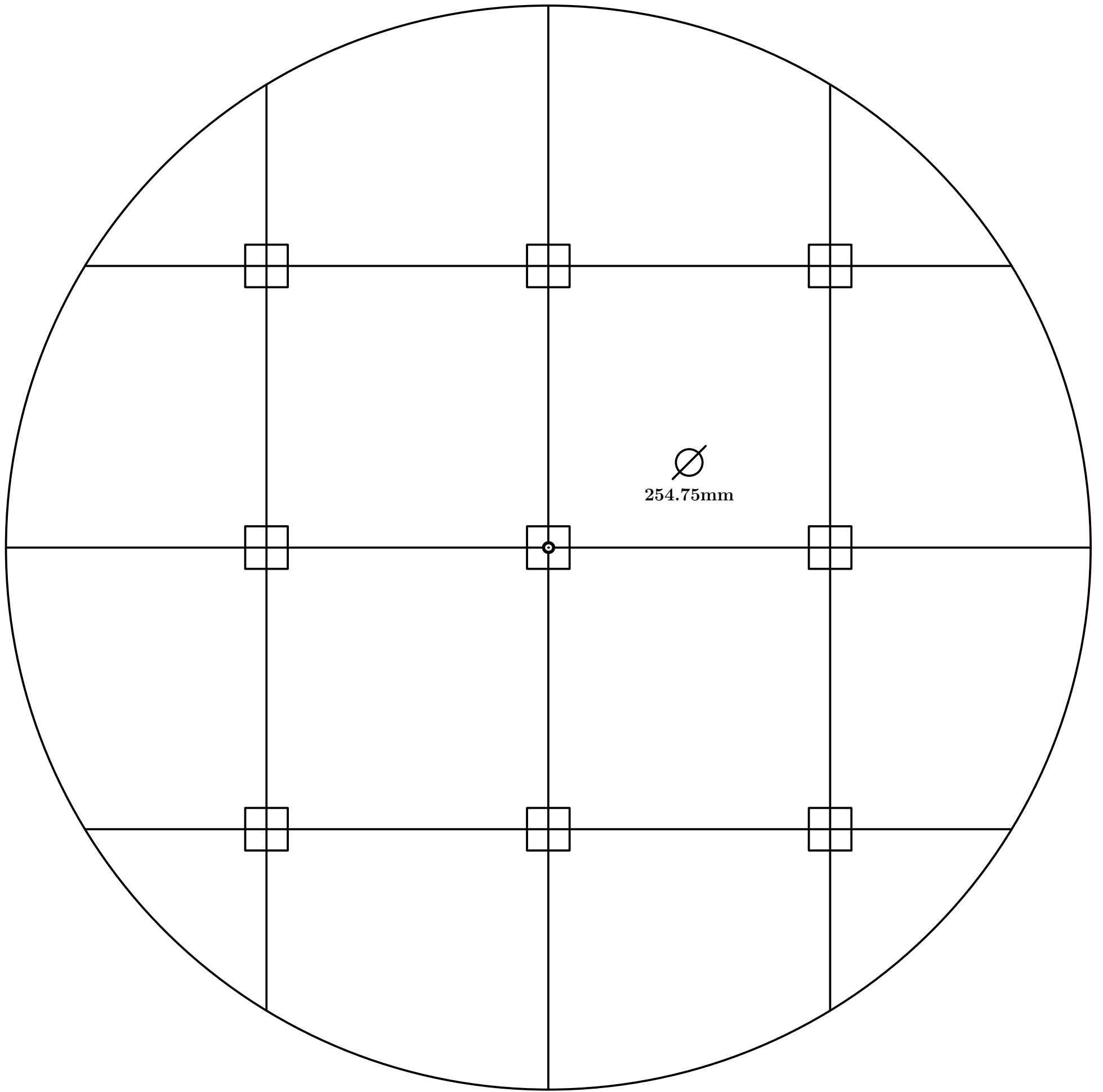

Fig. 620

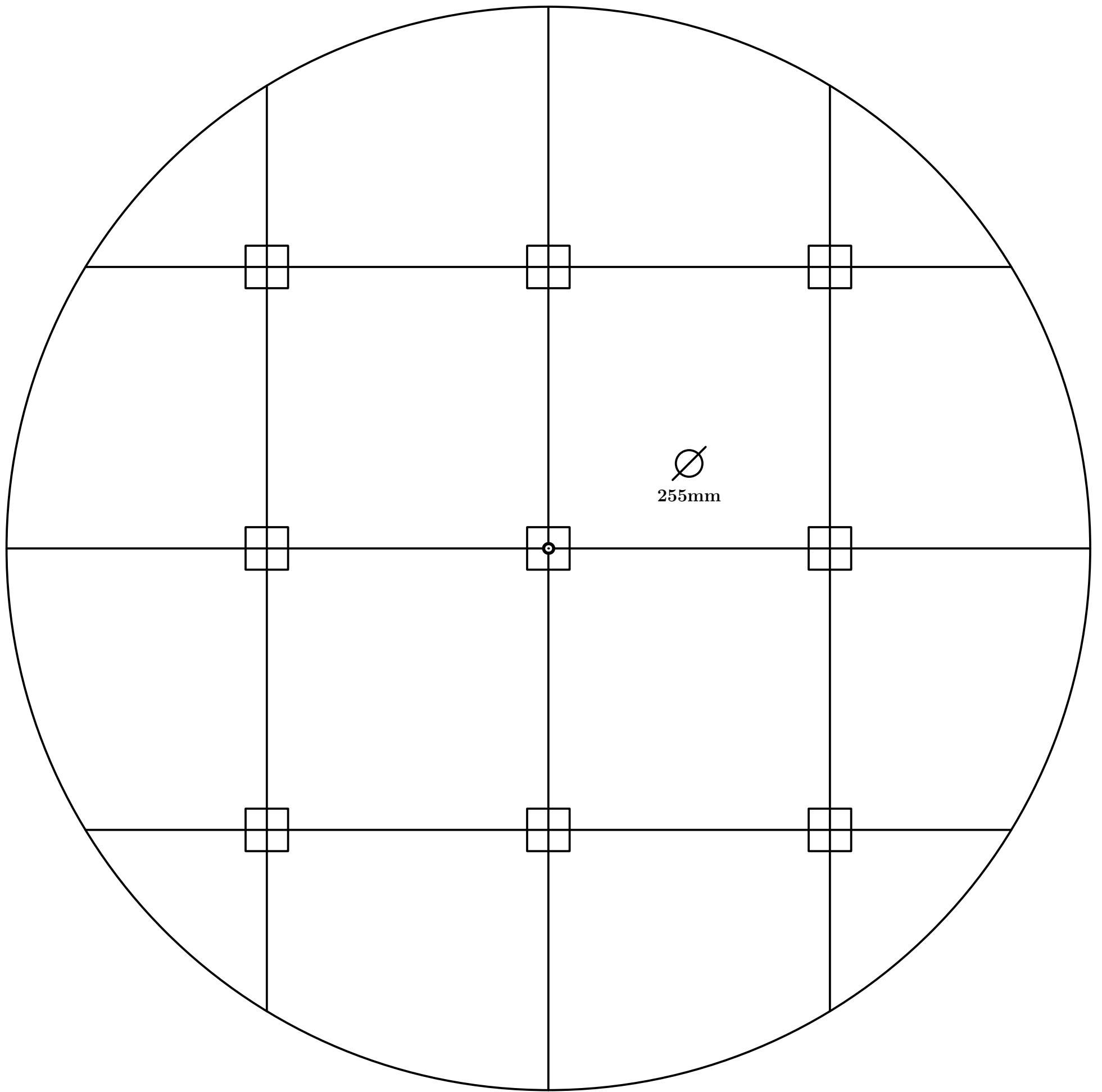

Fig. 621

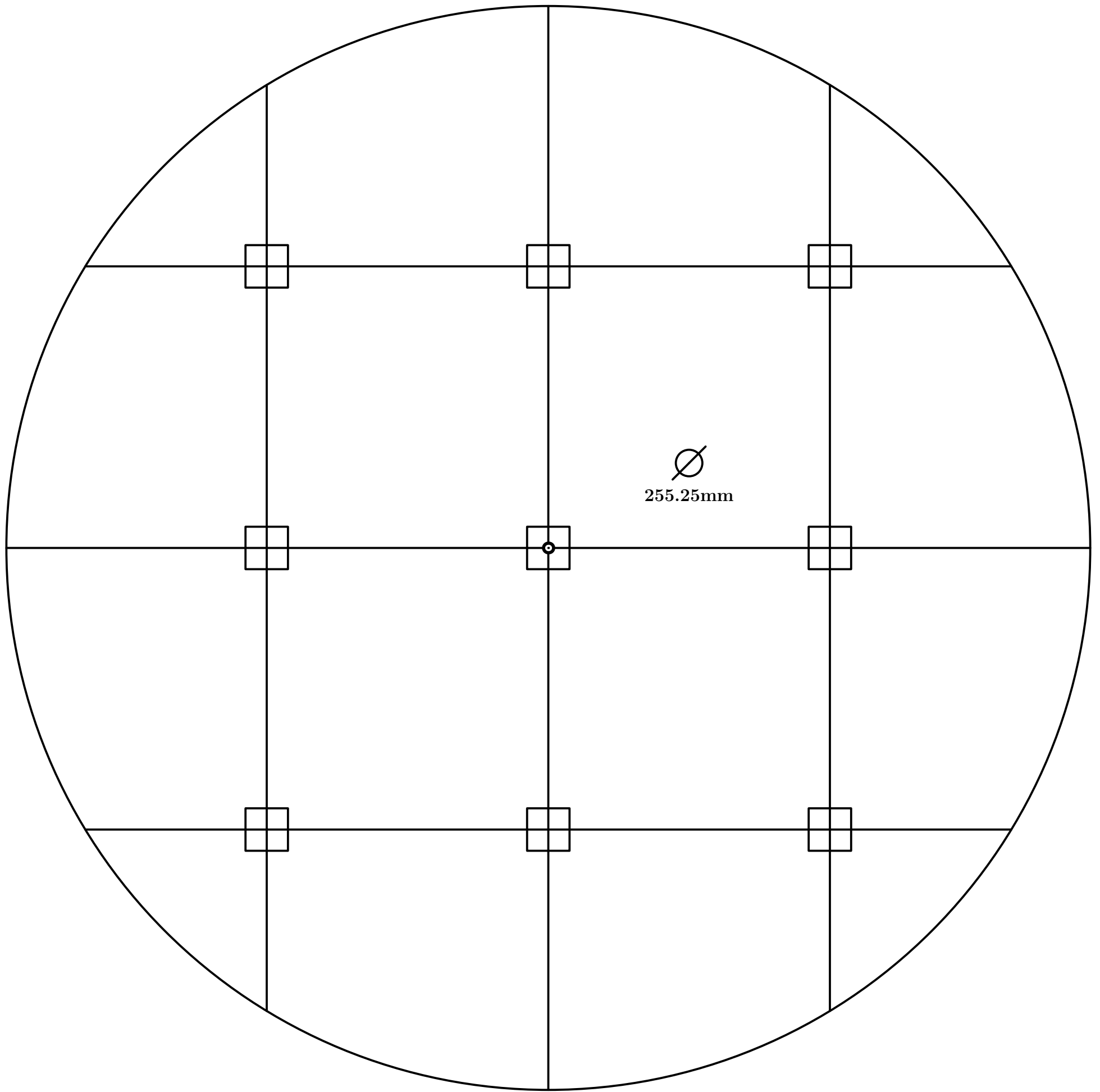

Fig. 622

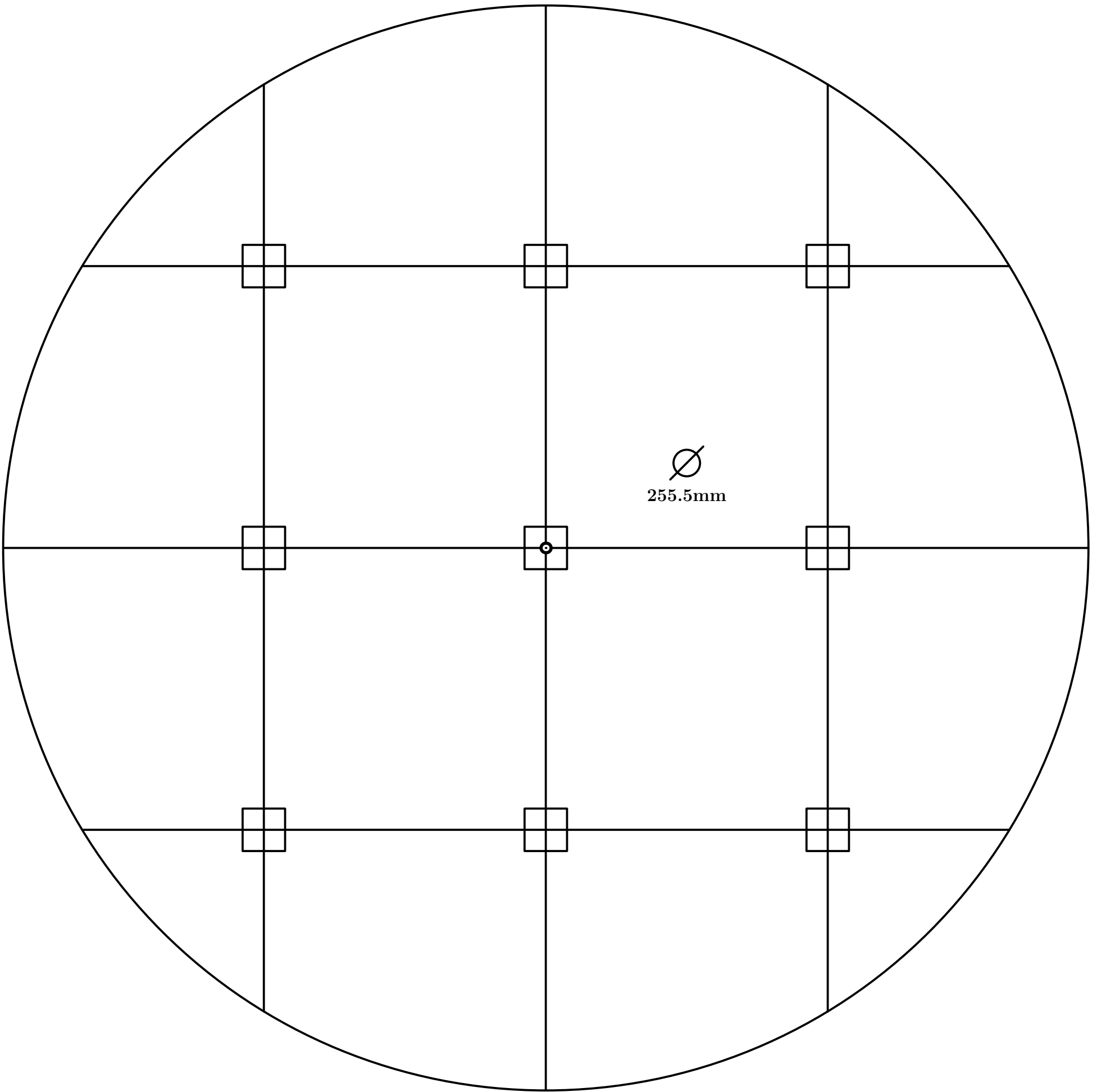

Fig. 623

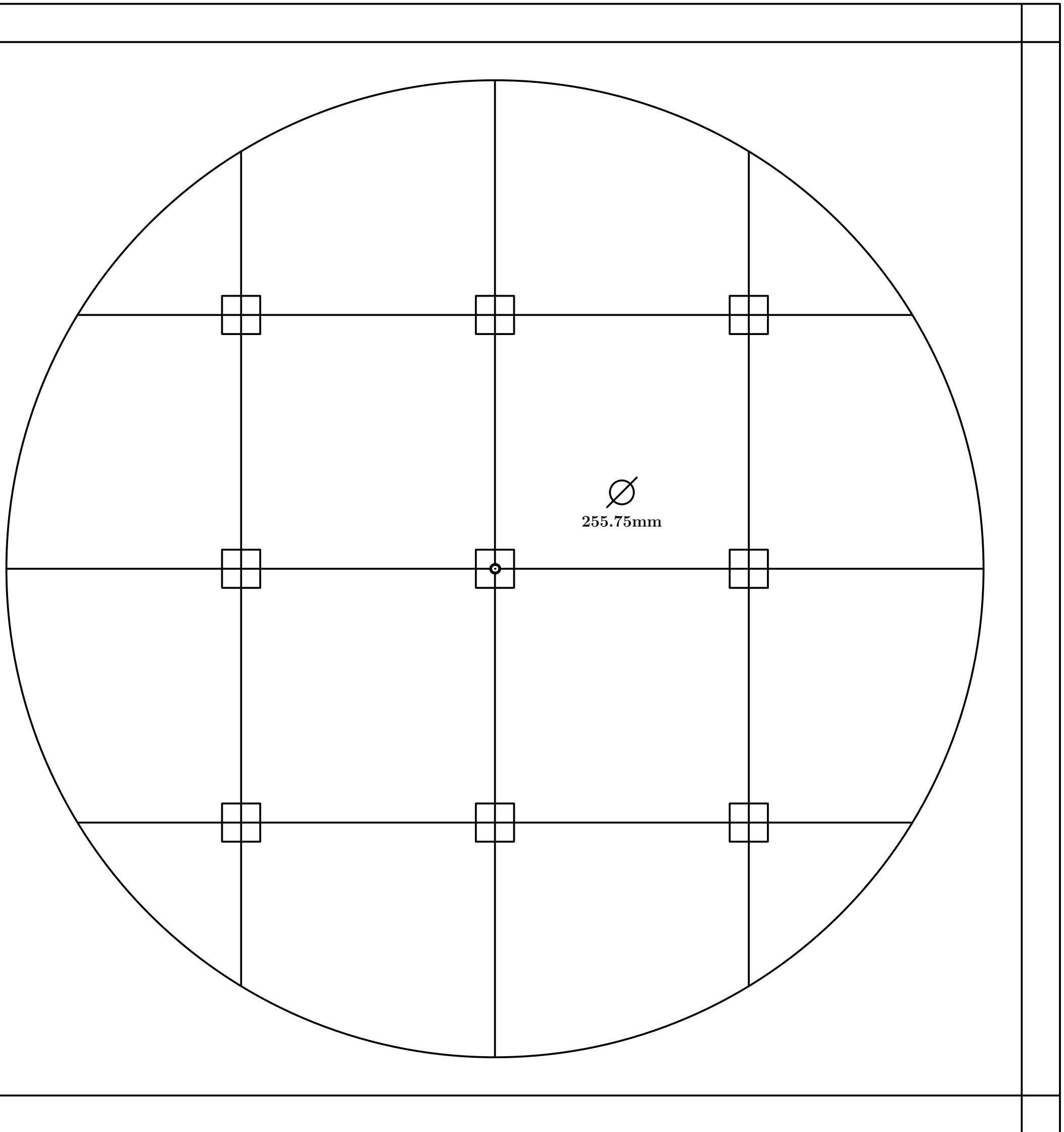

Fig. 624

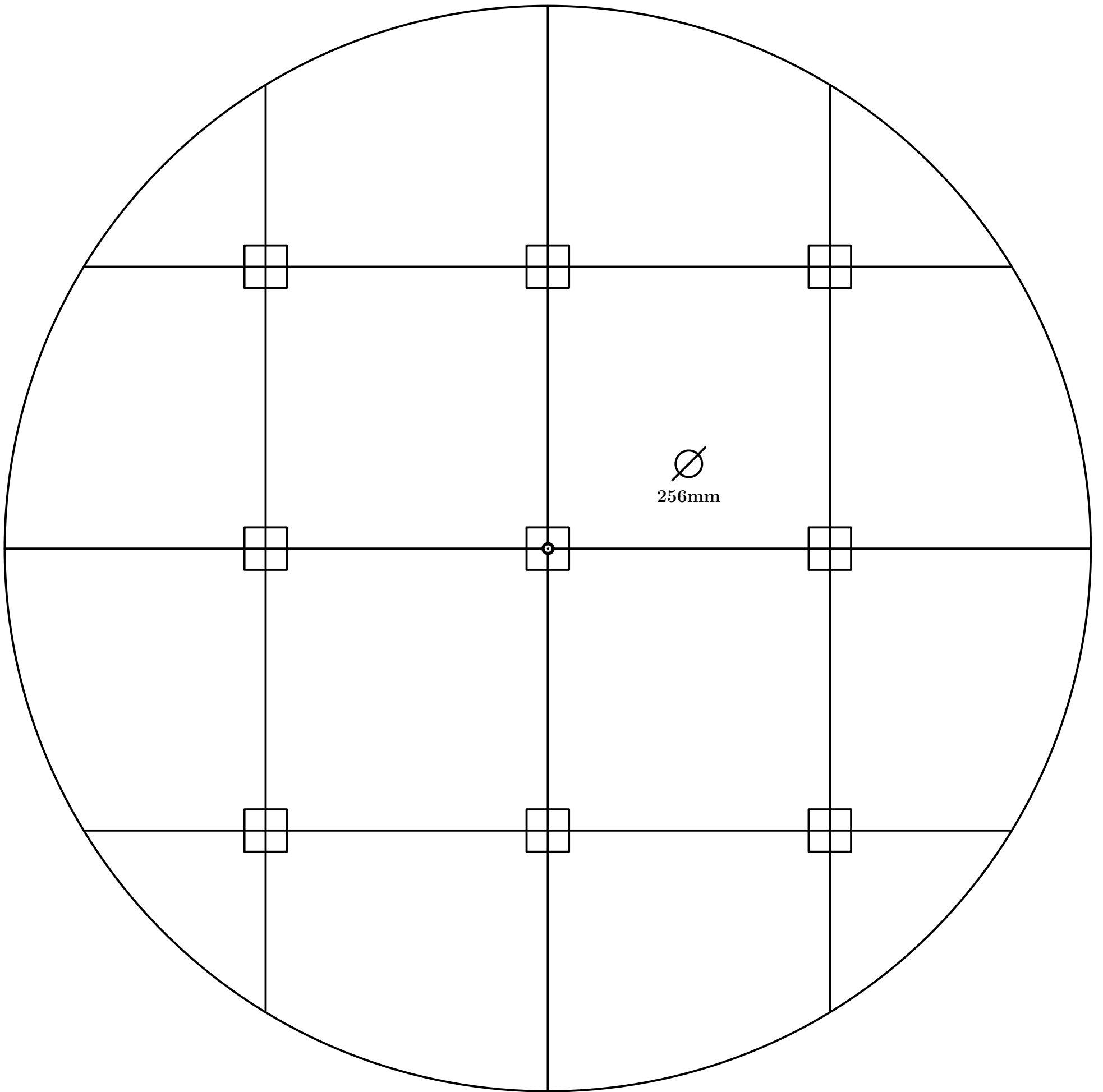

Fig. 625

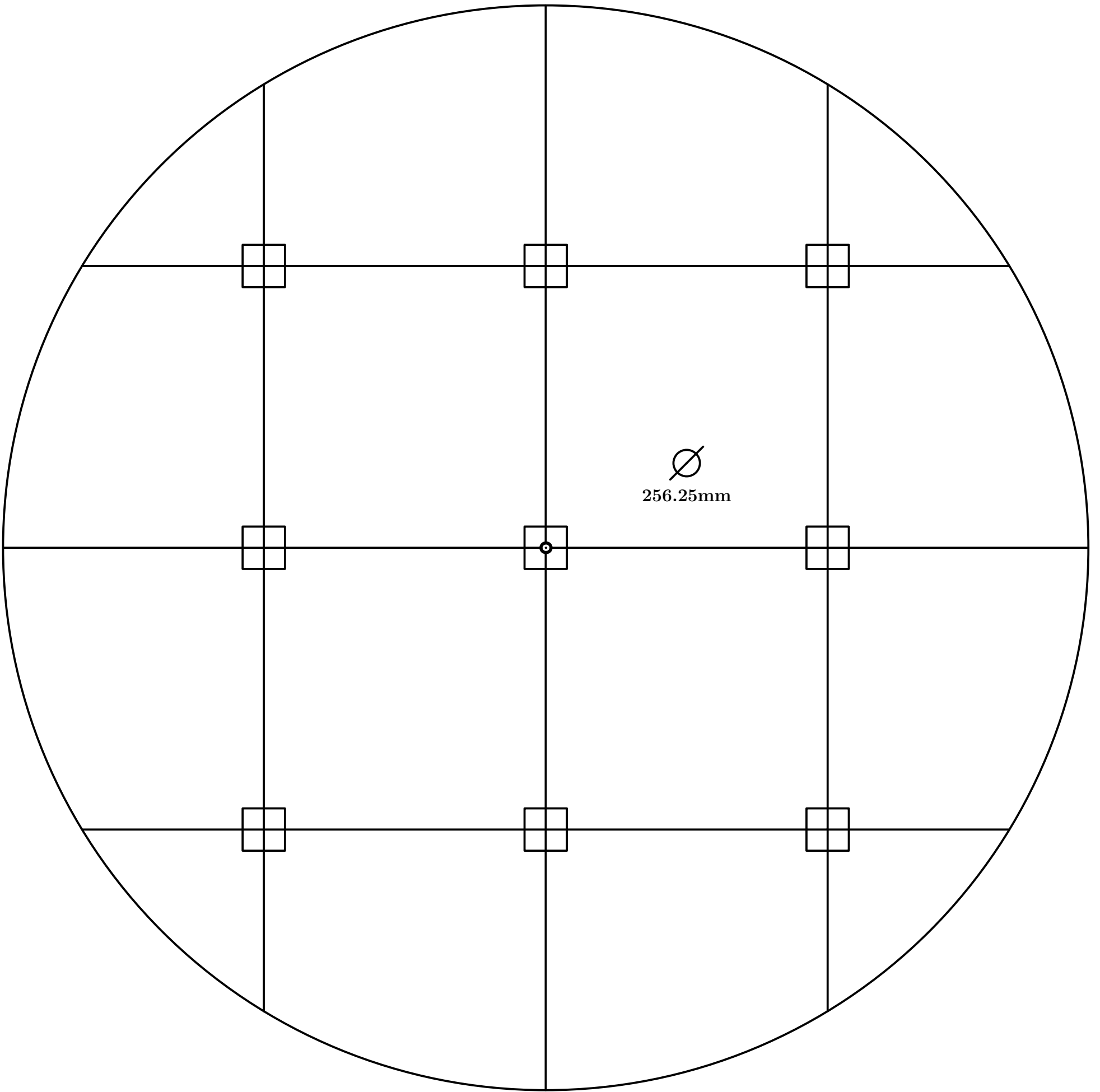

Fig. 626

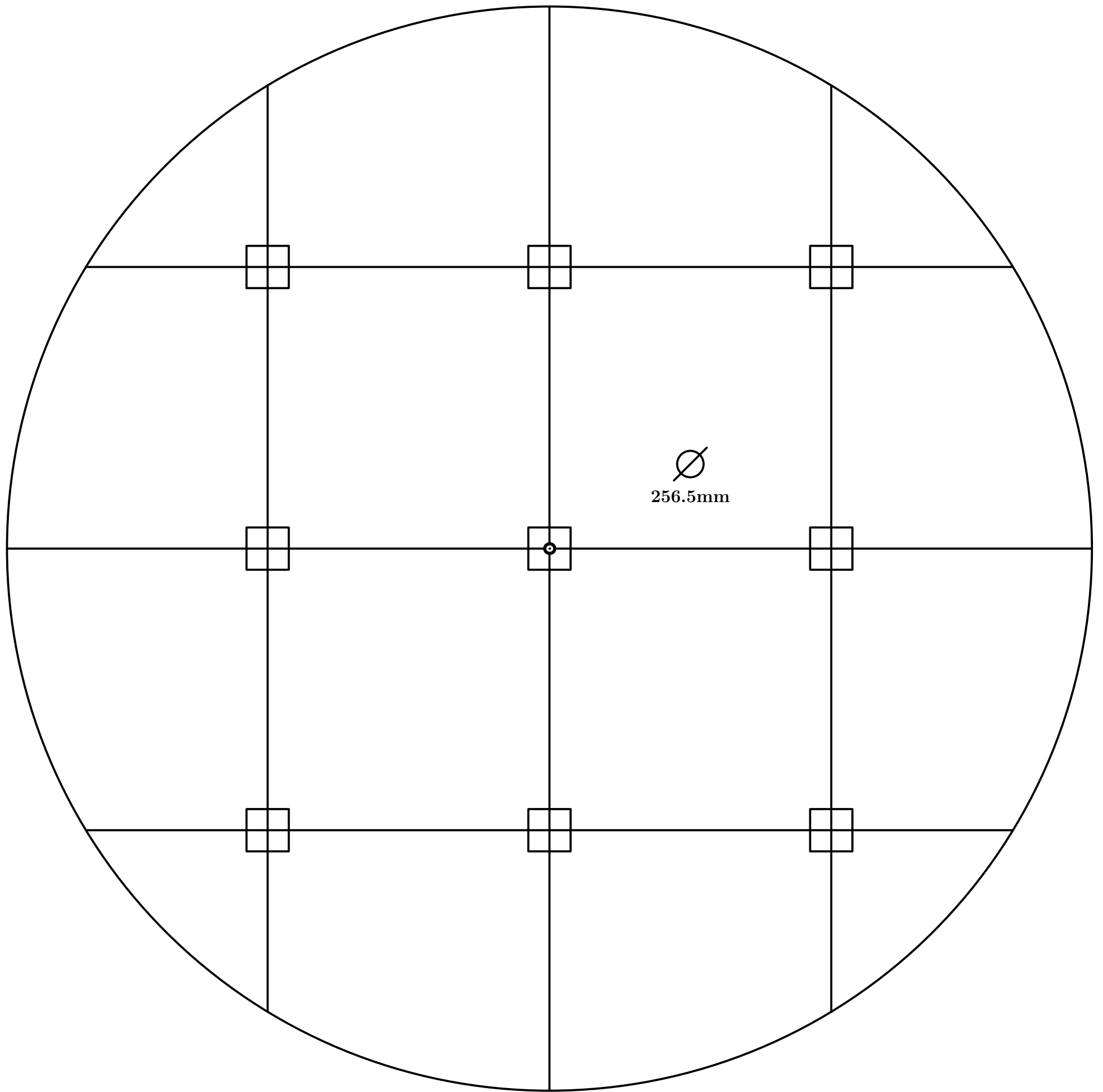

Fig. 627

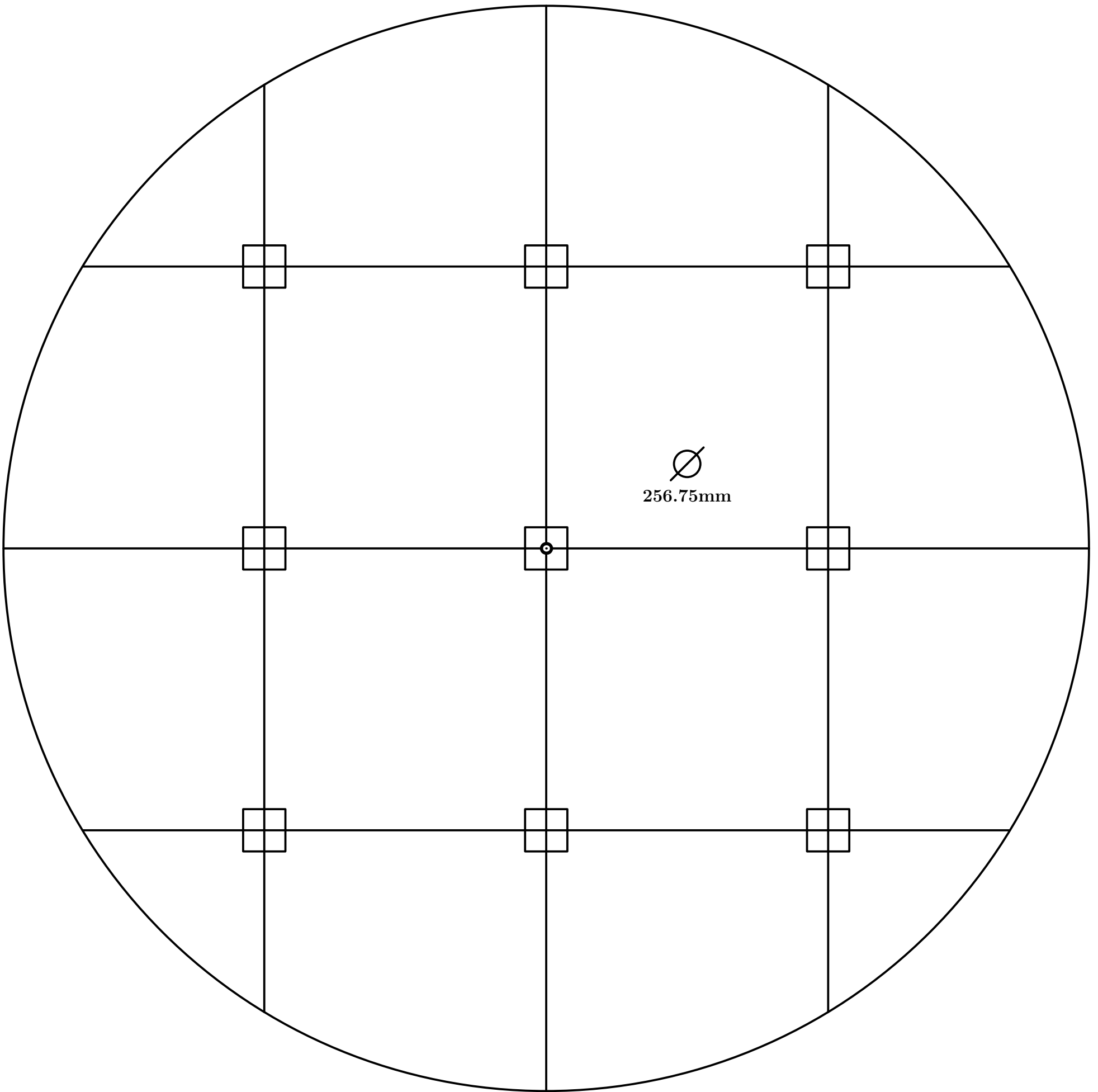

Fig. 628

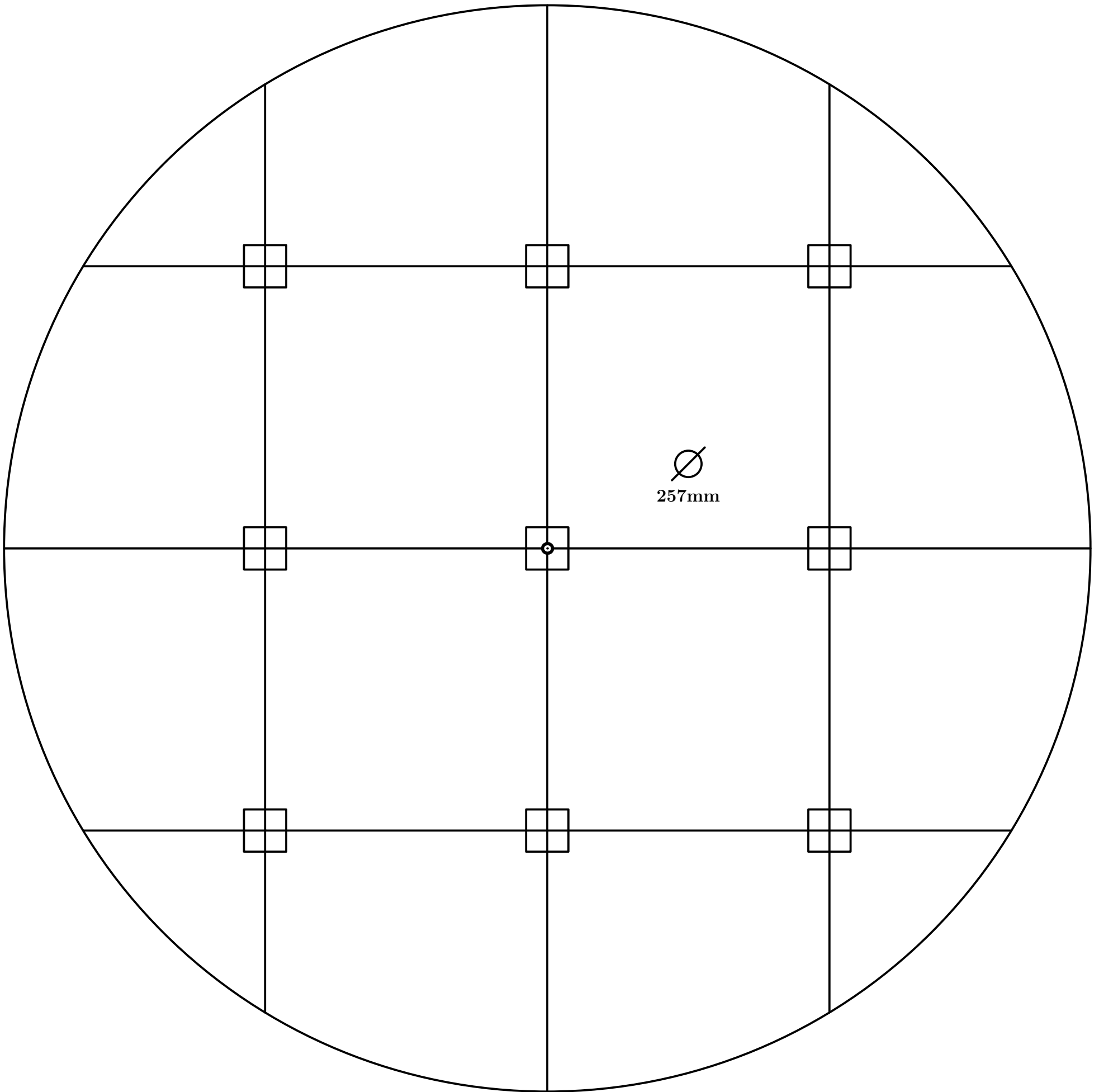

Fig. 629

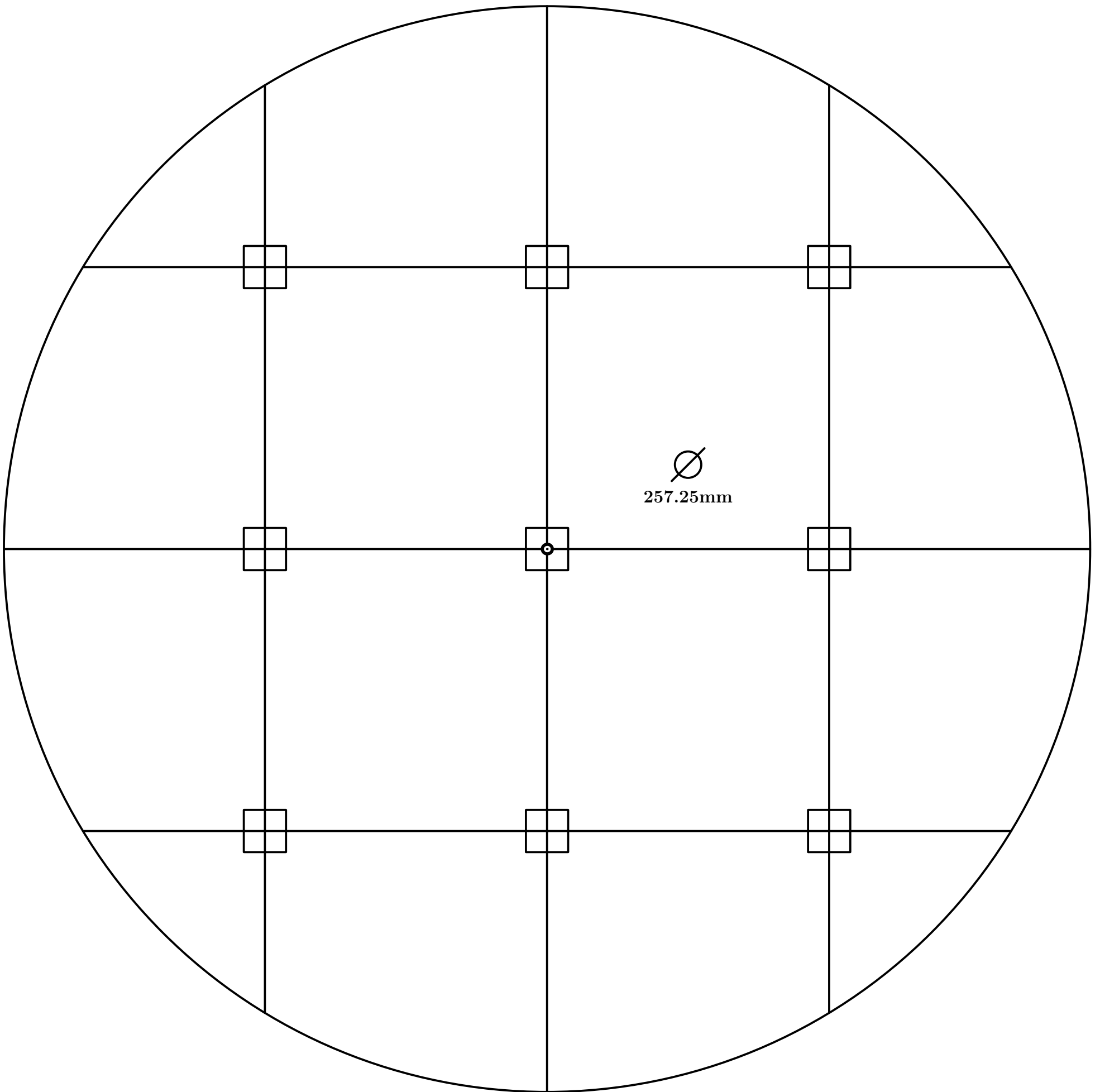

Fig. 630

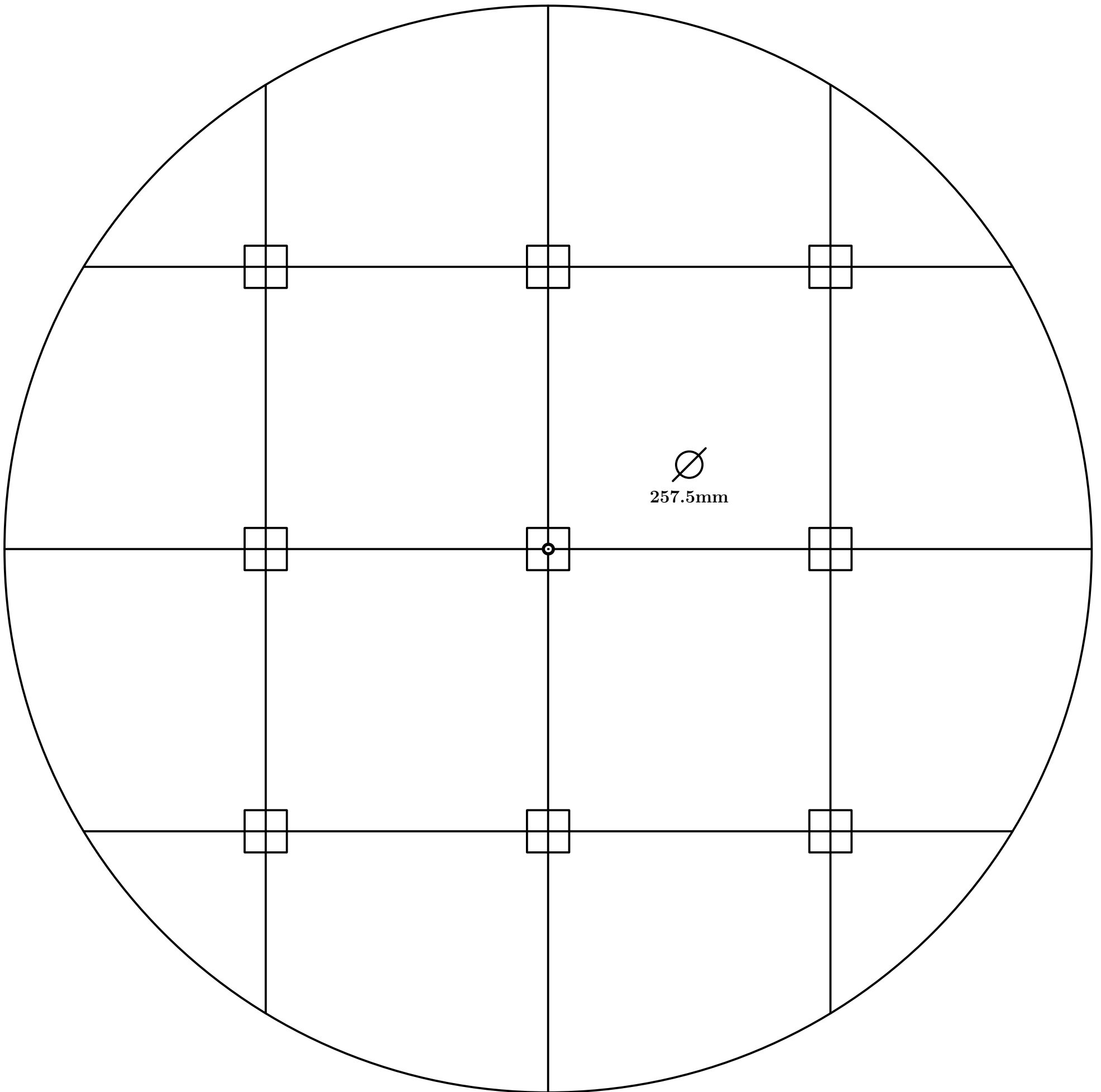

Fig. 631

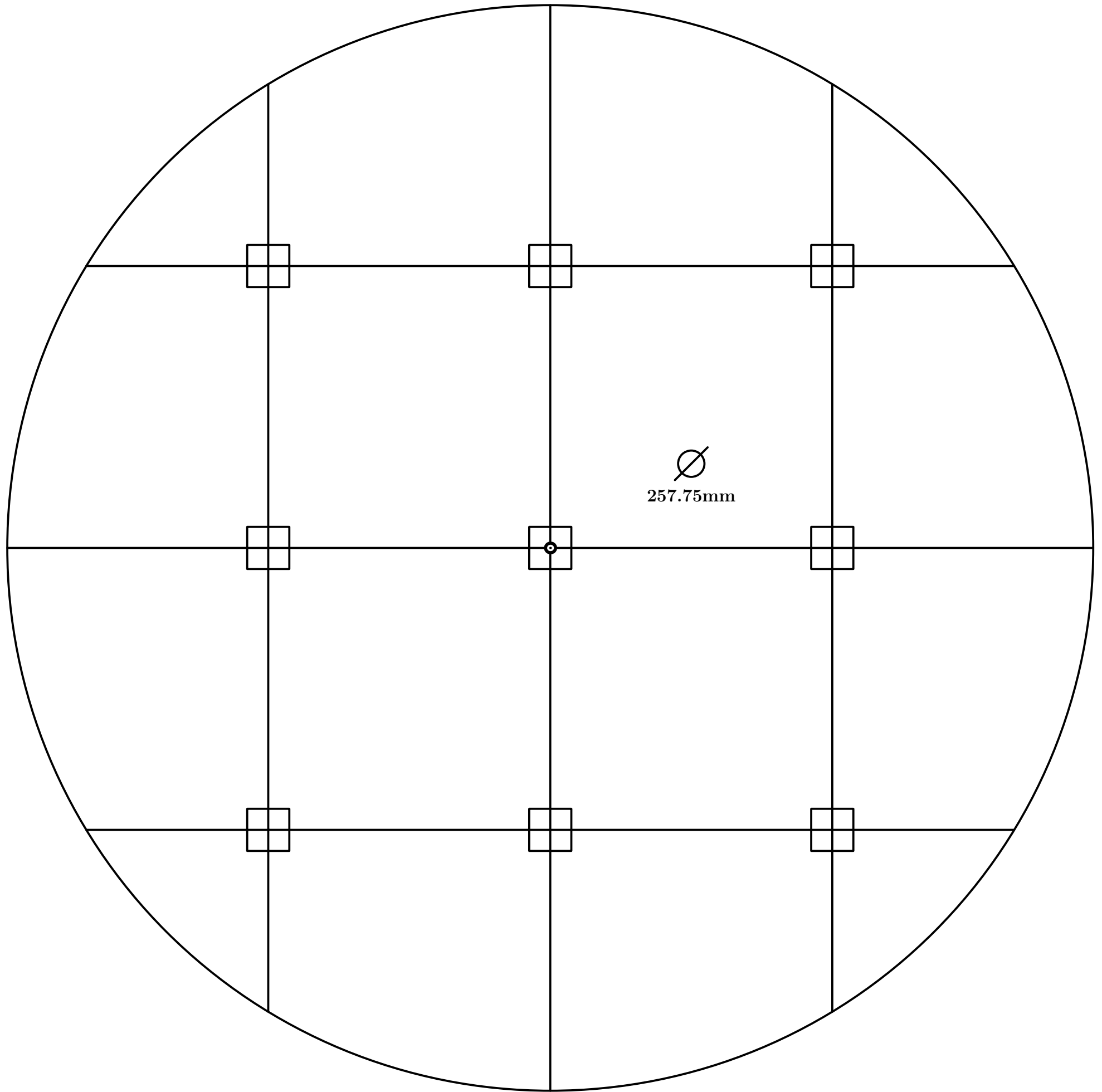

Fig. 632

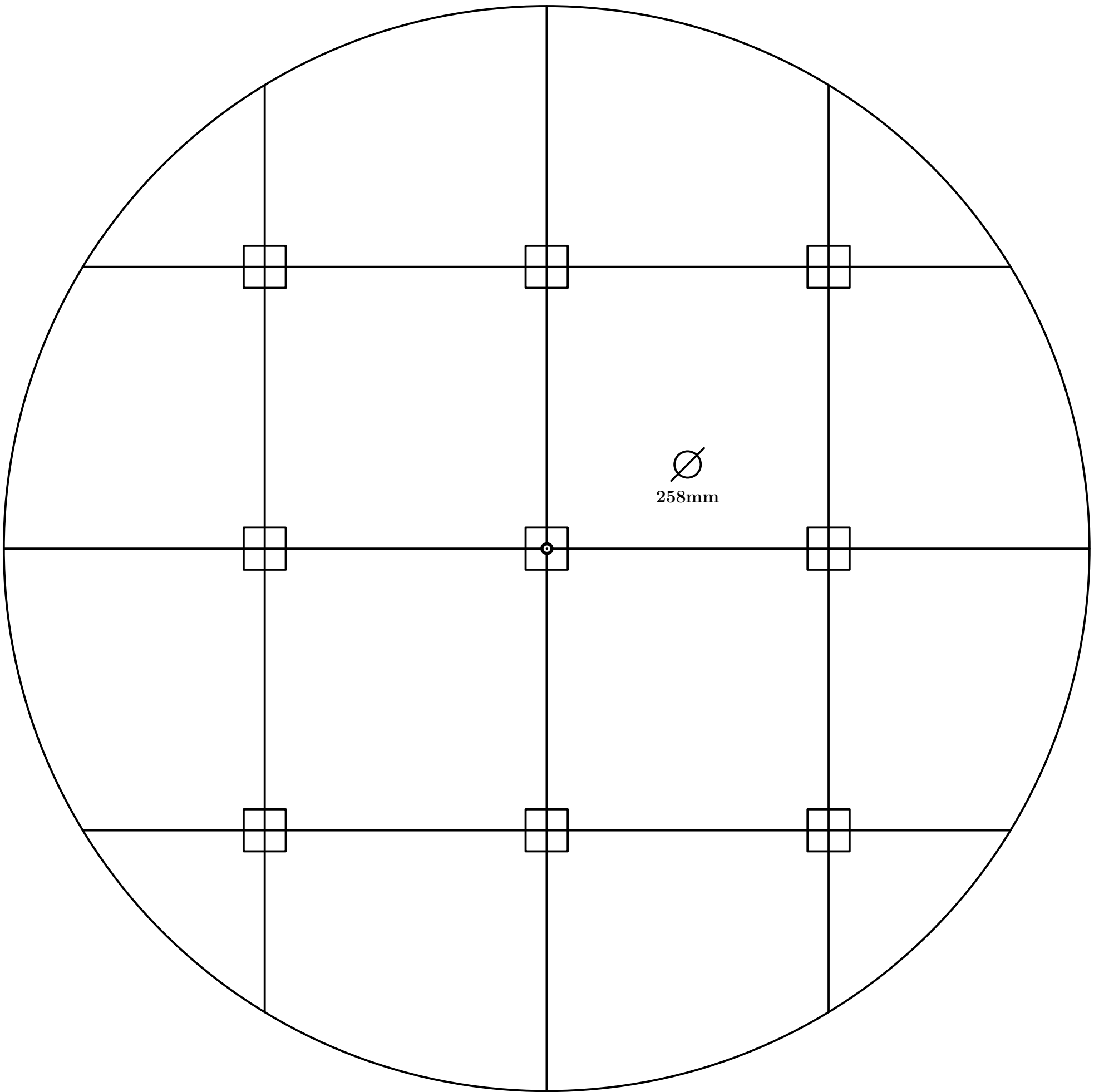

Fig. 633

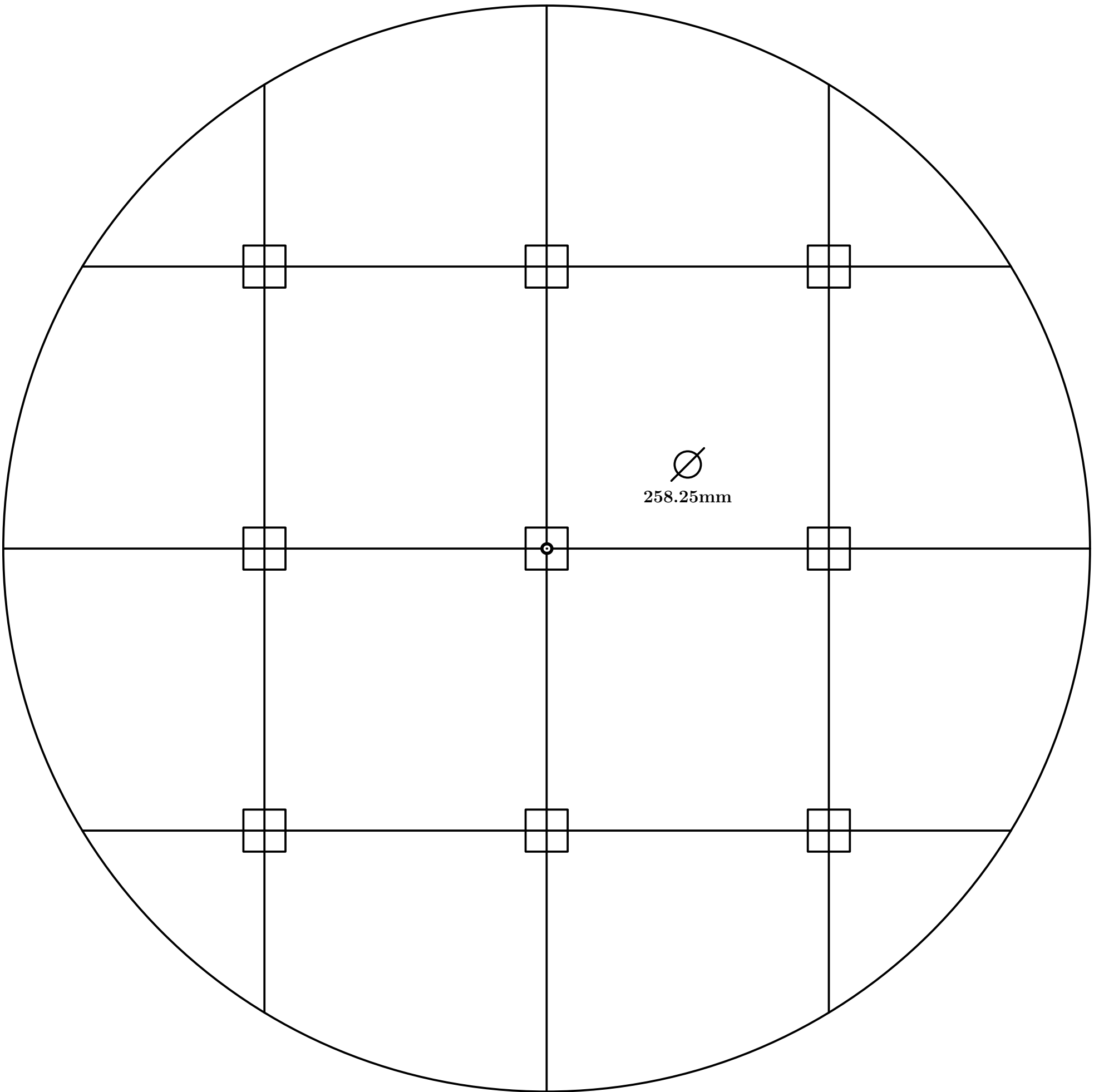

Fig. 634

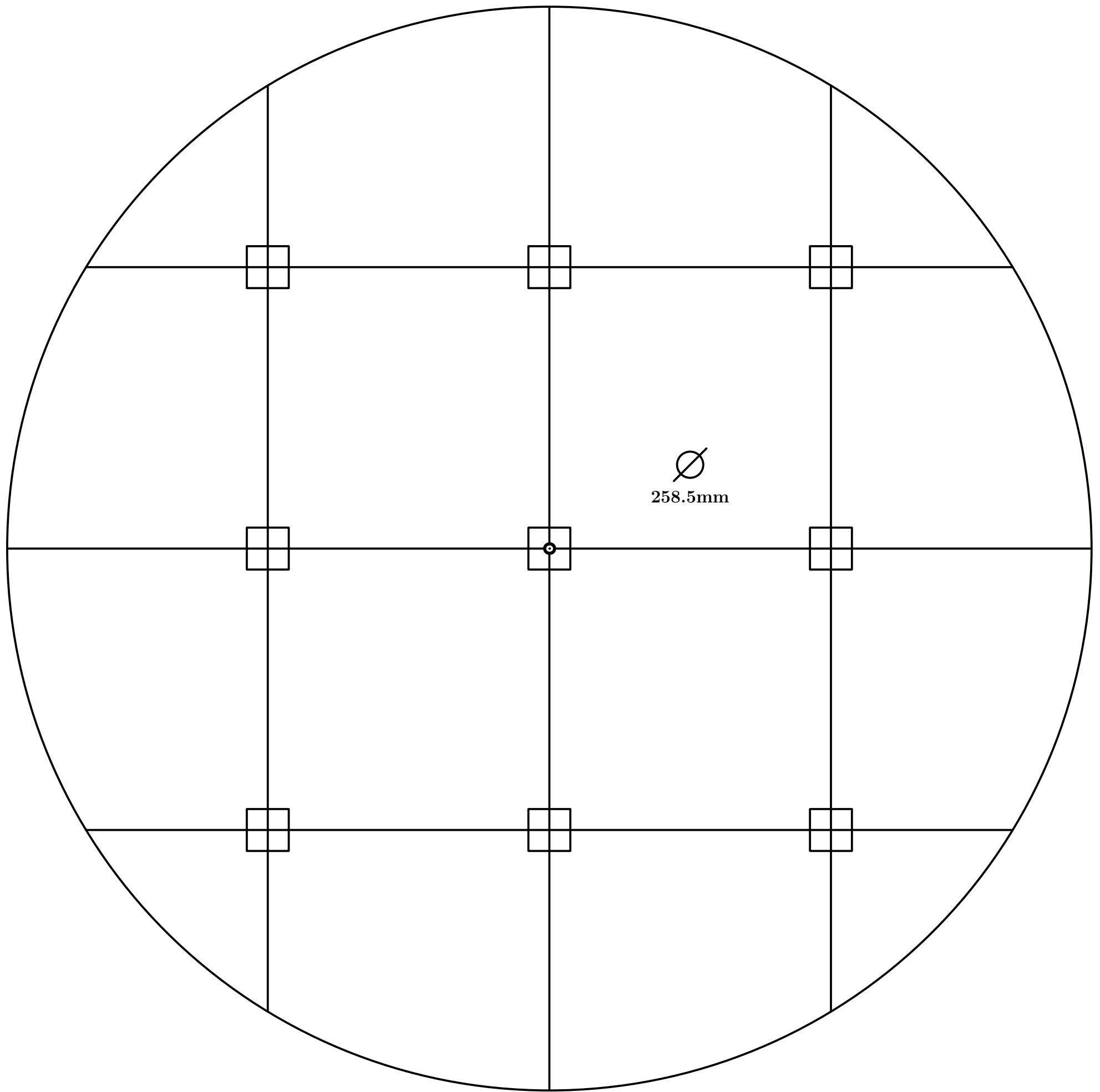

Fig. 635

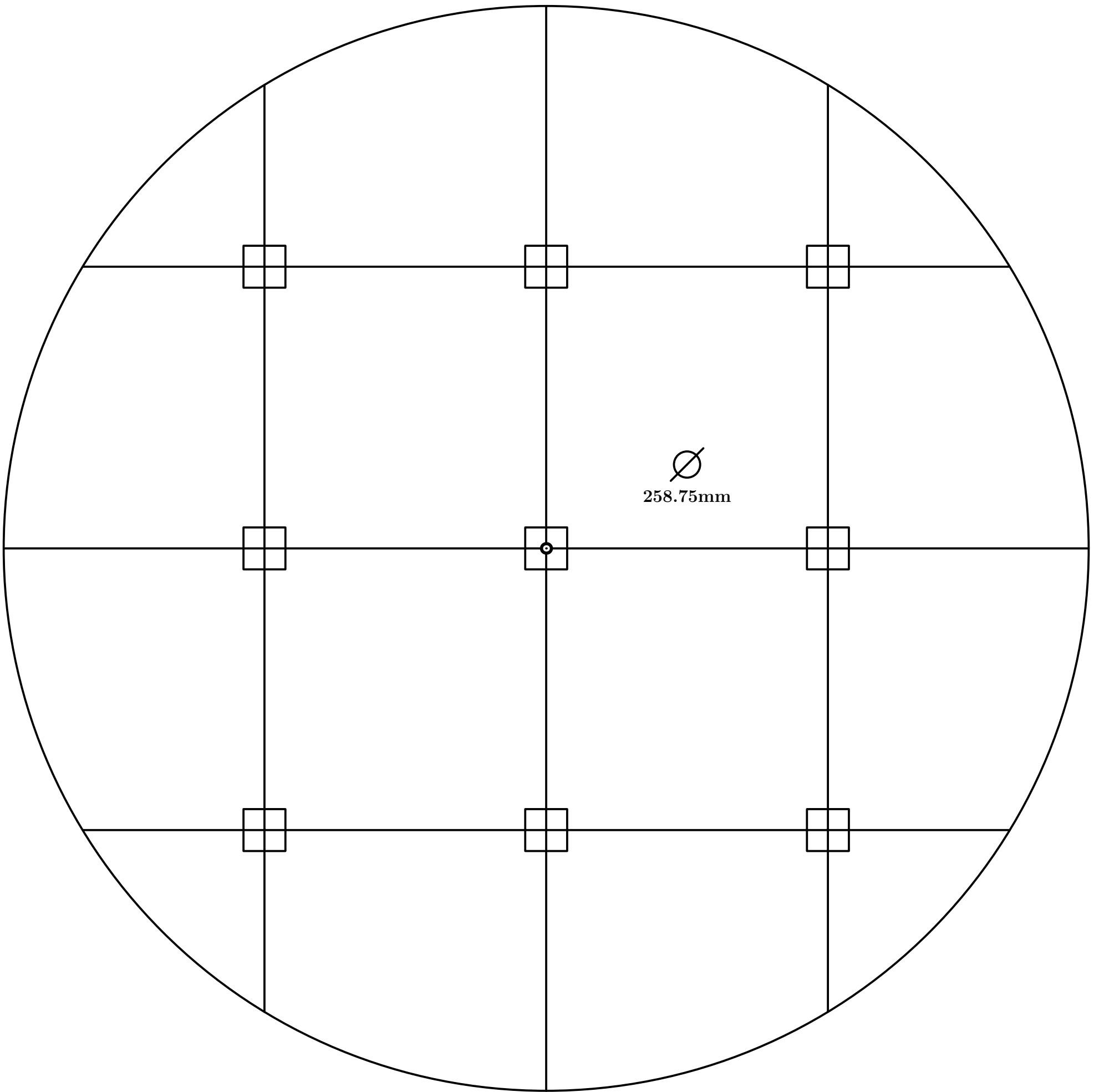

Fig. 636

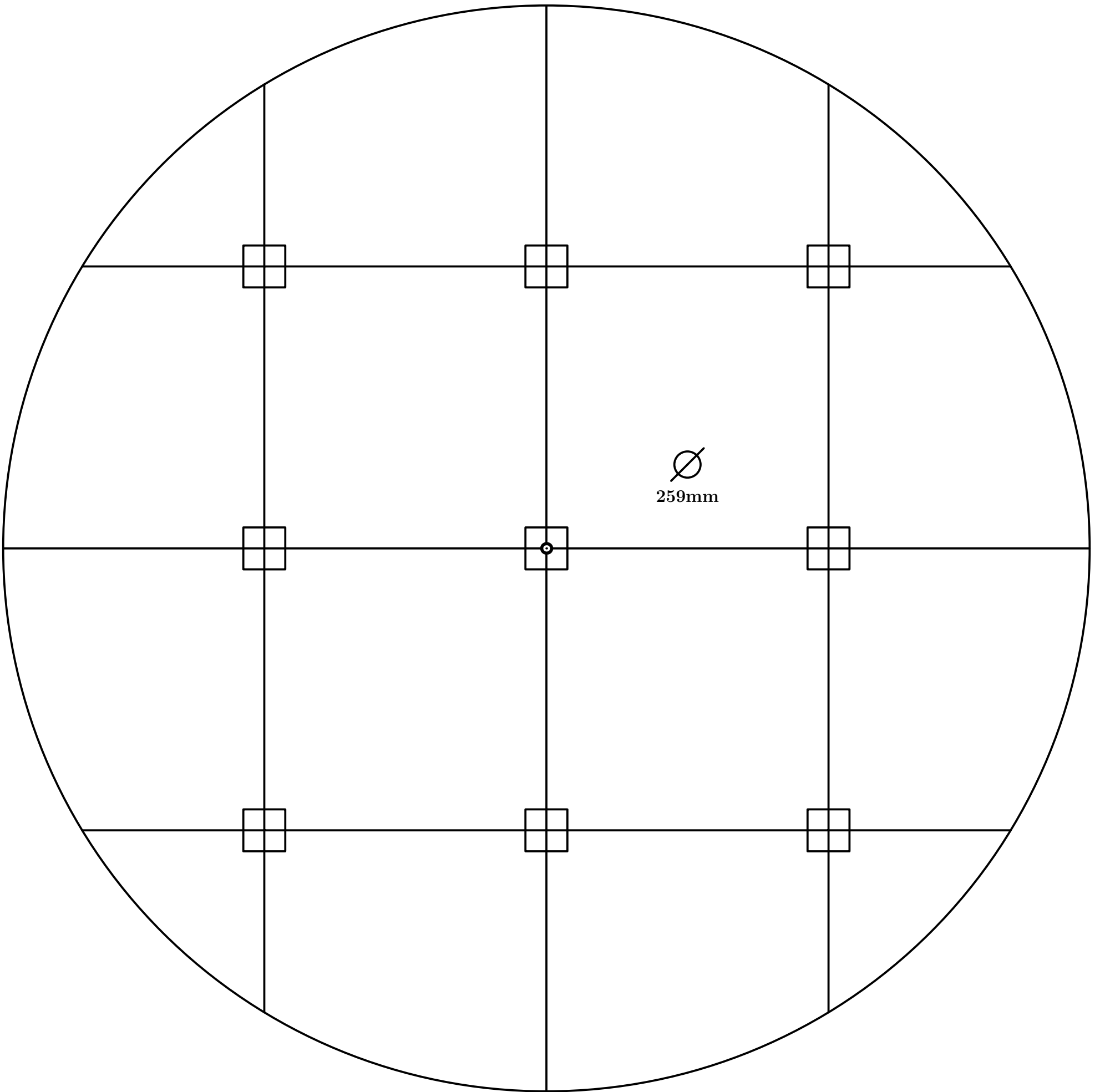

Fig. 637

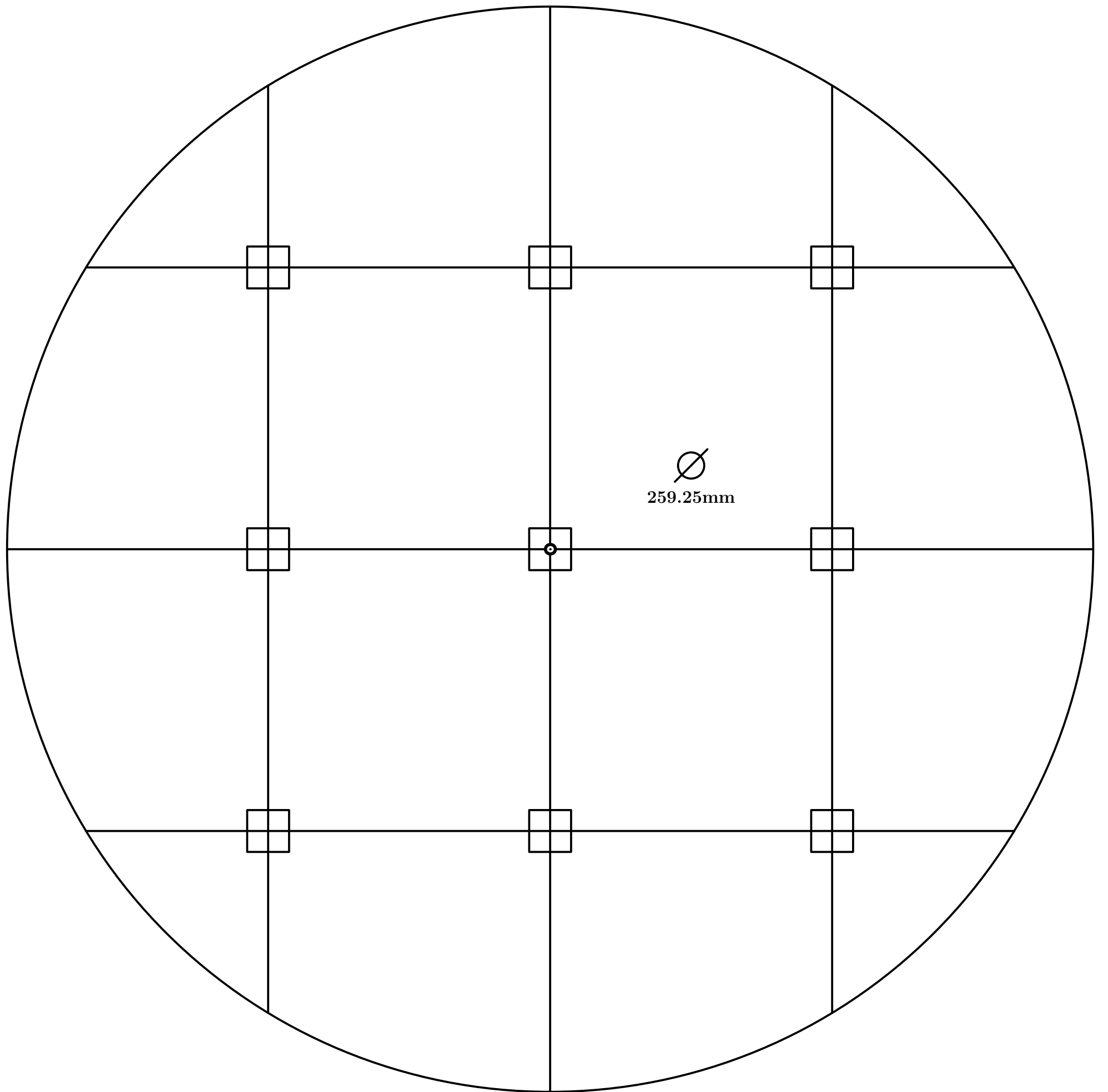

Fig. 638

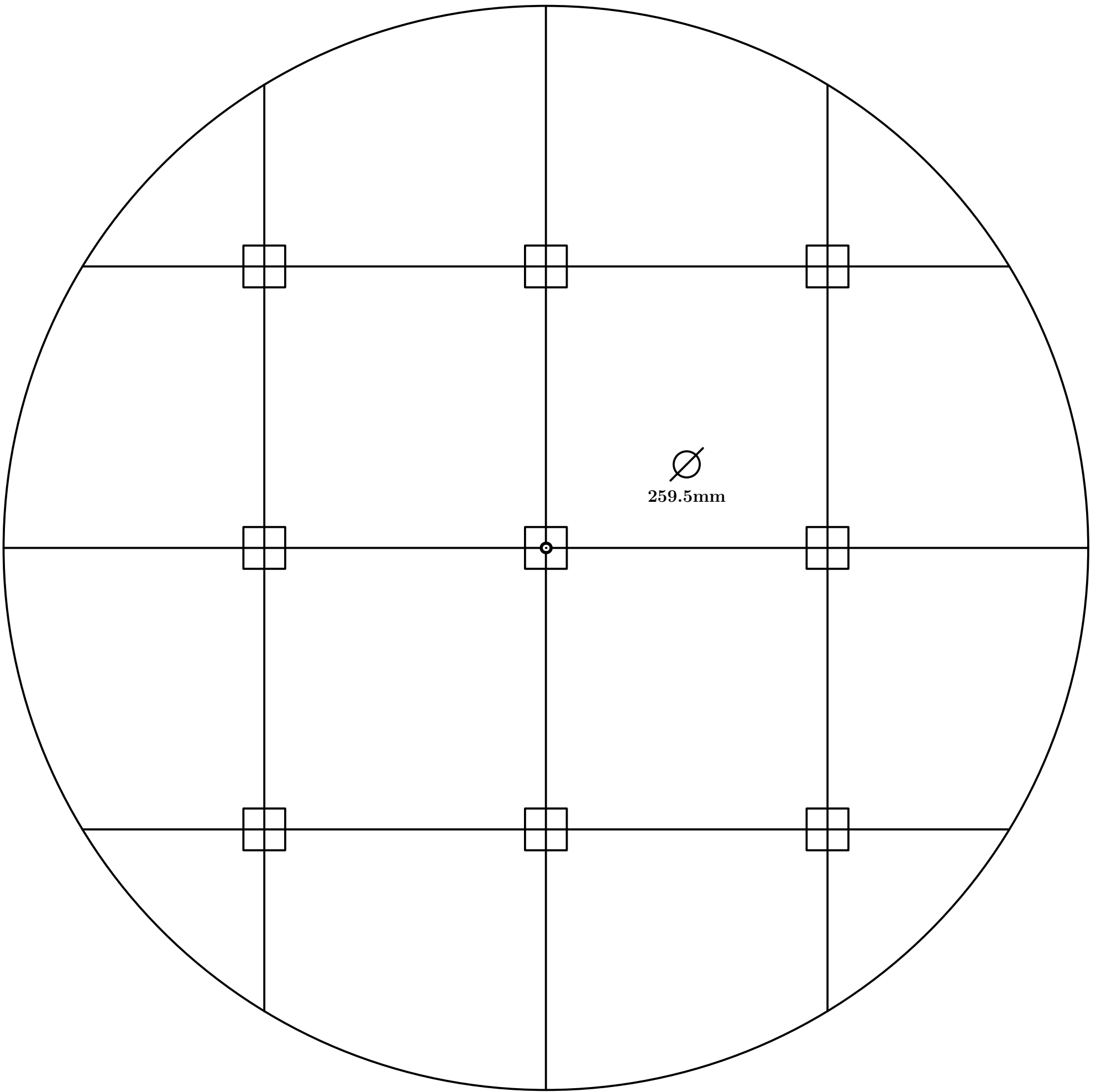

Fig. 639

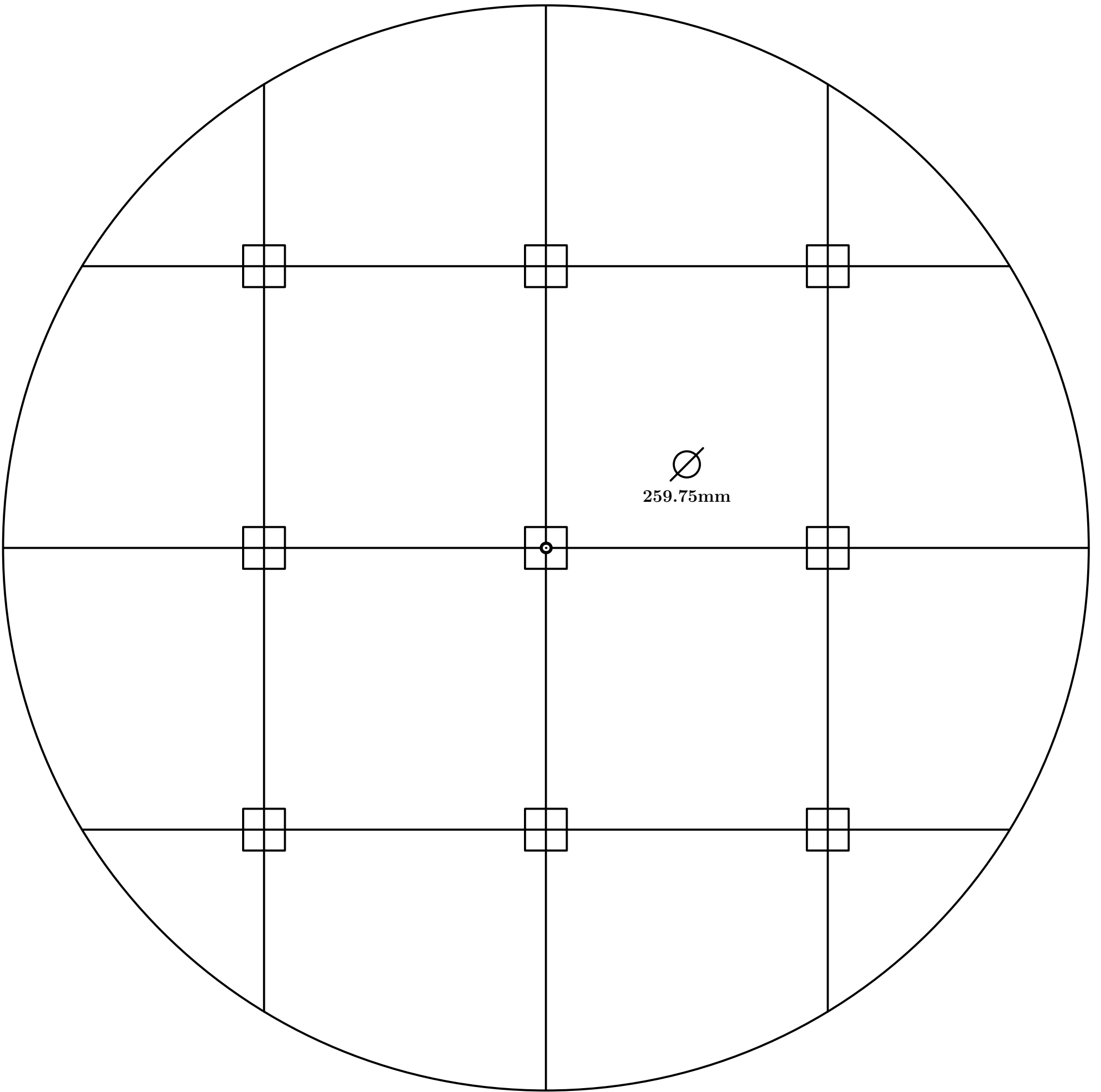

Fig. 640

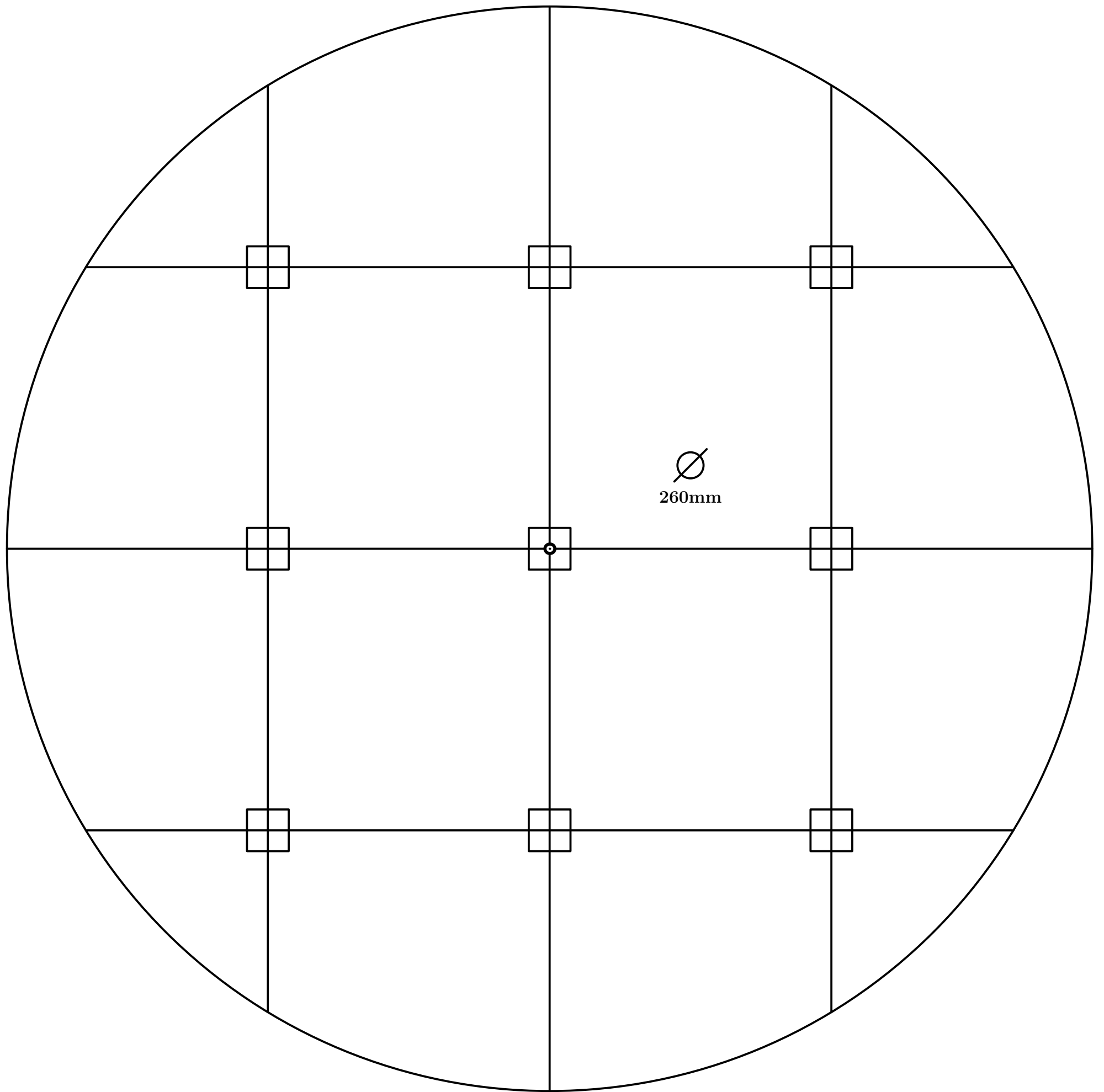

Fig. 641

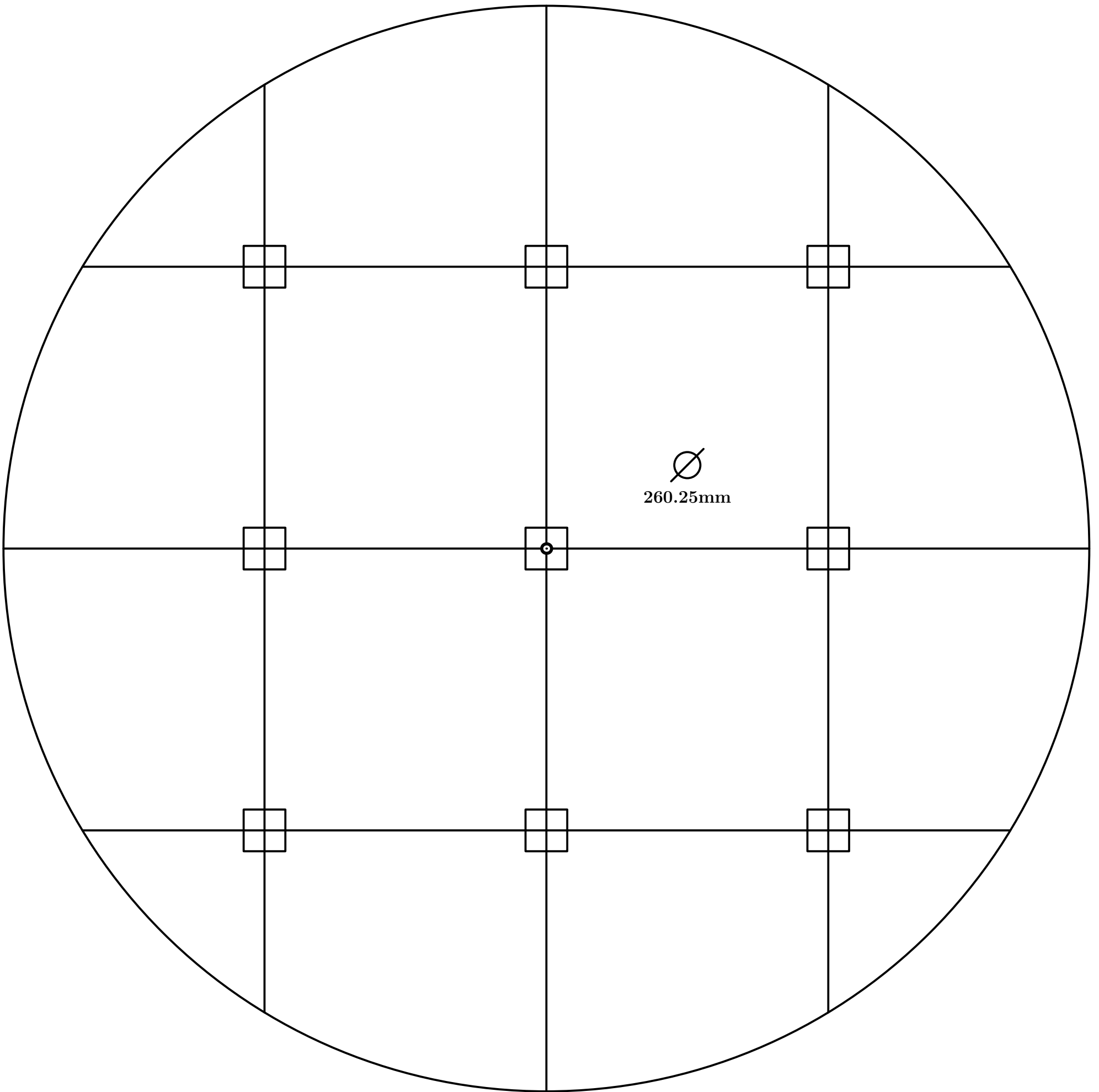

Fig. 642

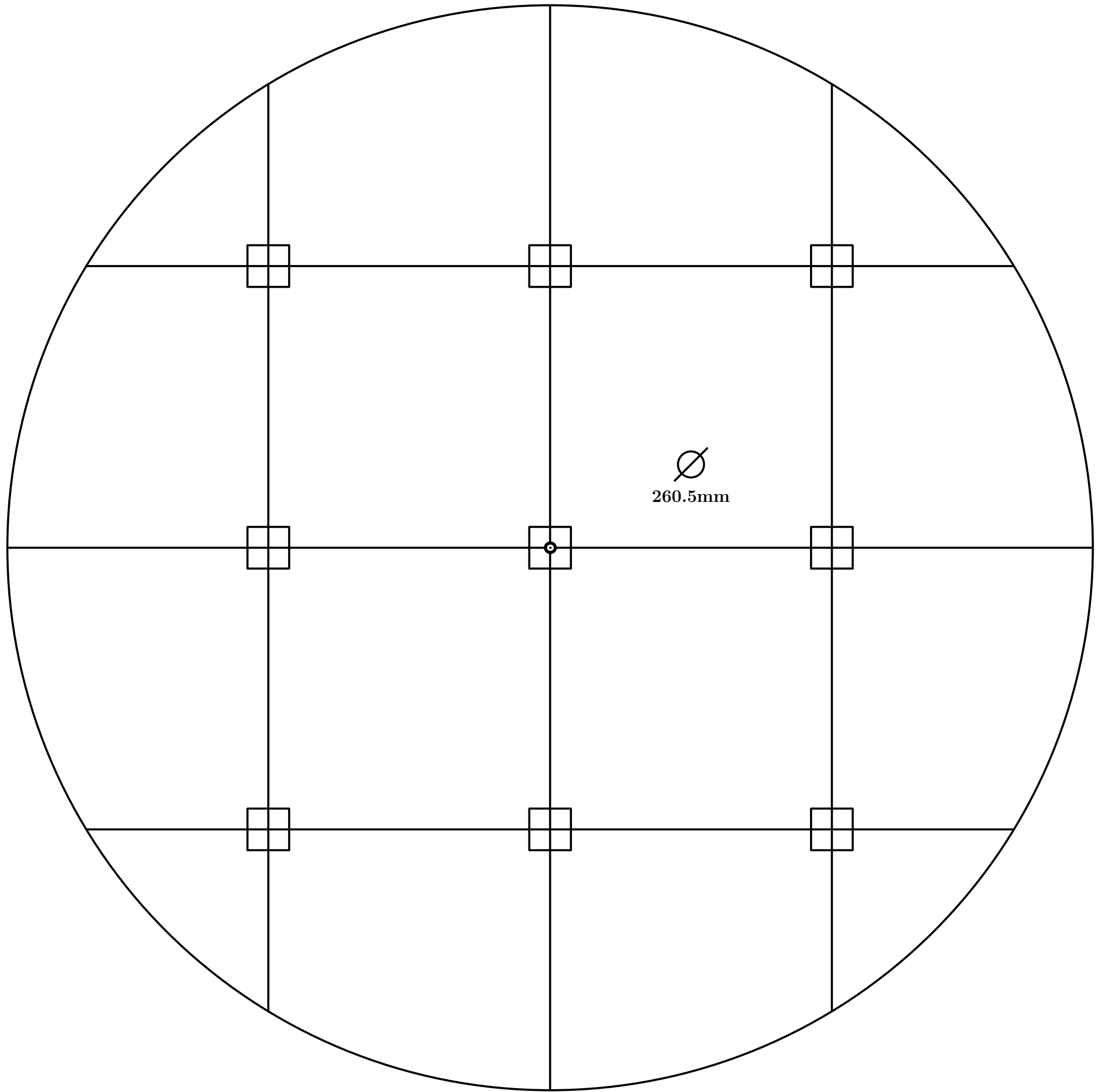

Fig. 643

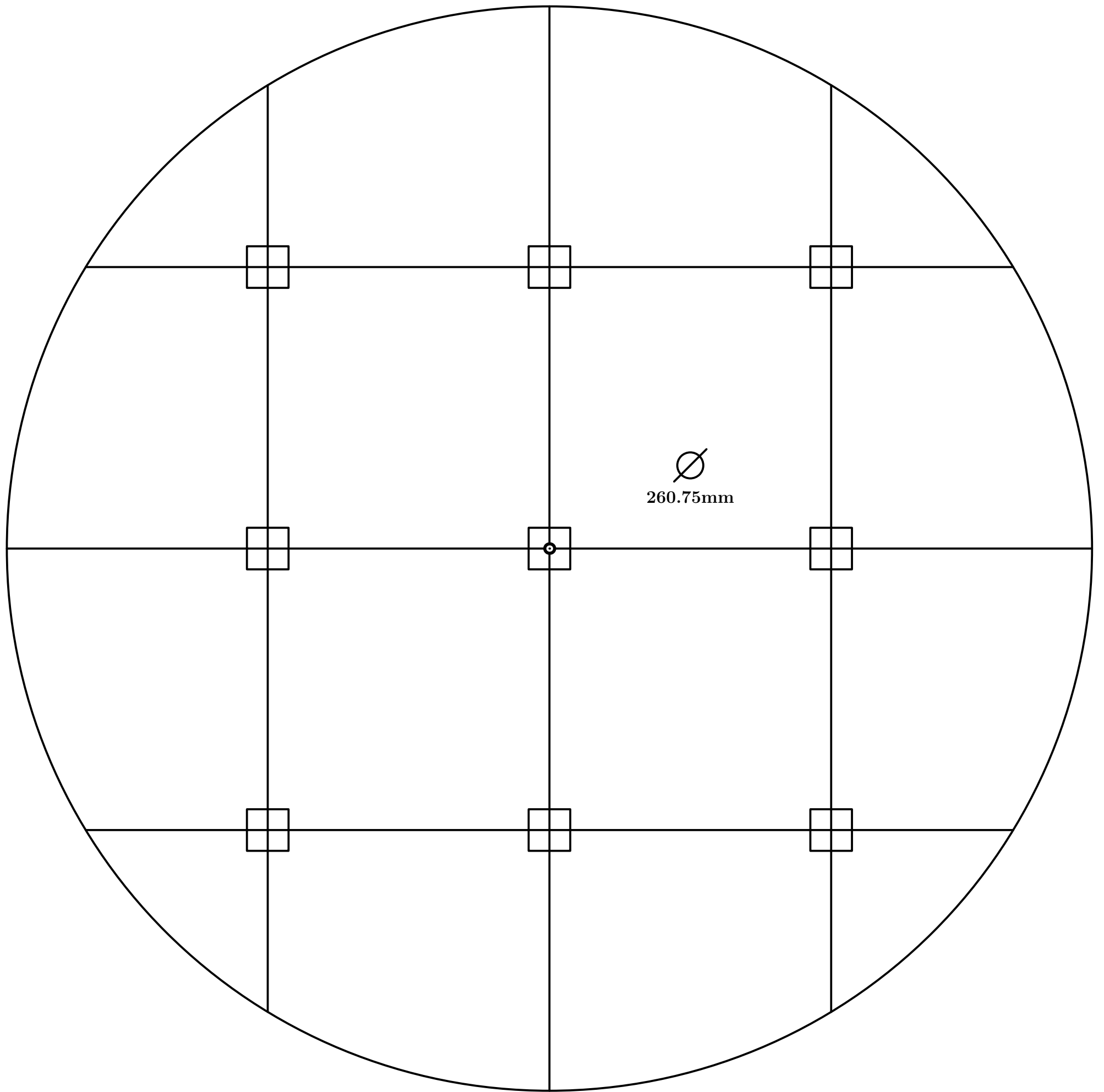

Fig. 644

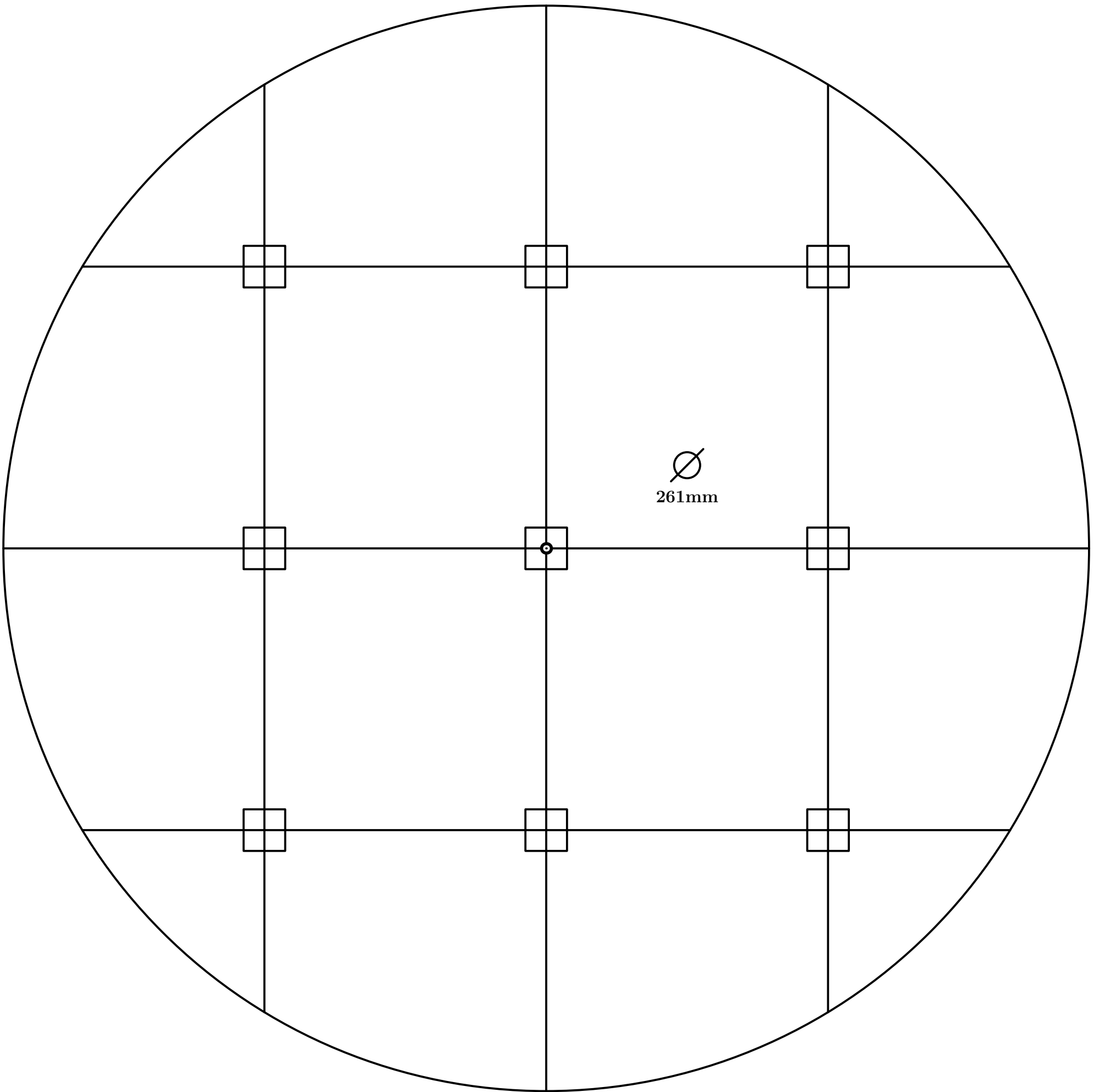

Fig. 645

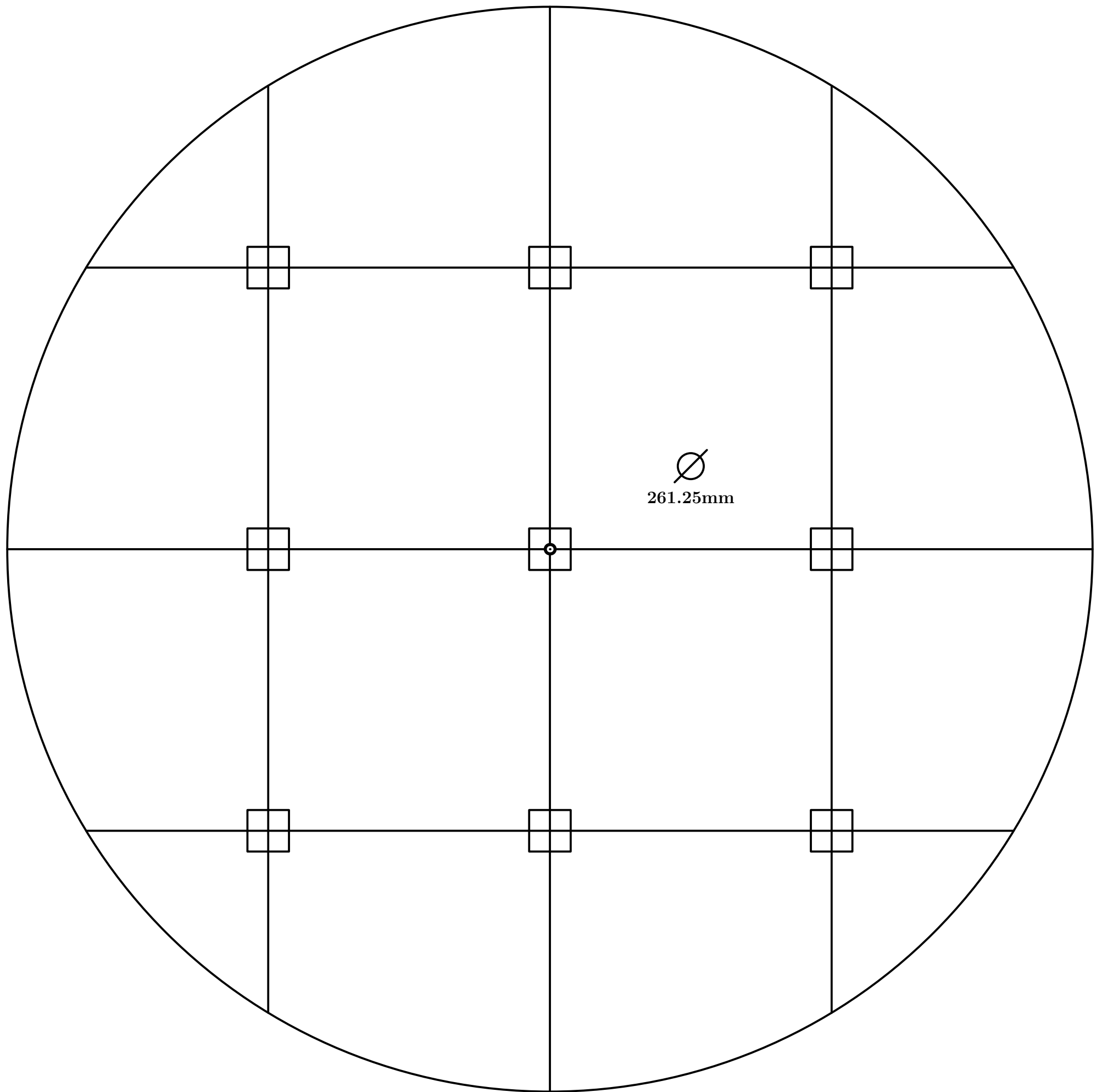

Fig. 646

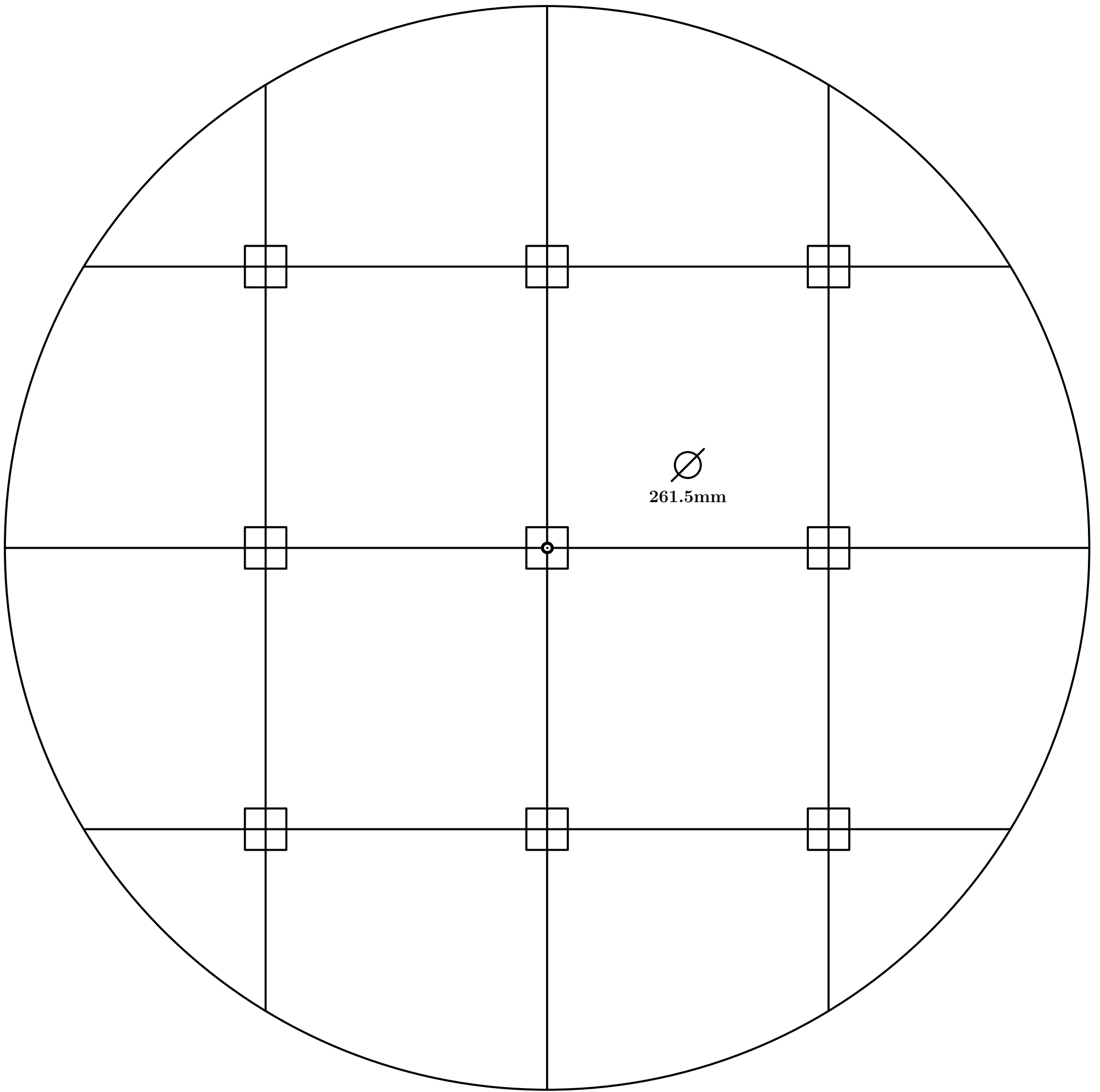

Fig. 647

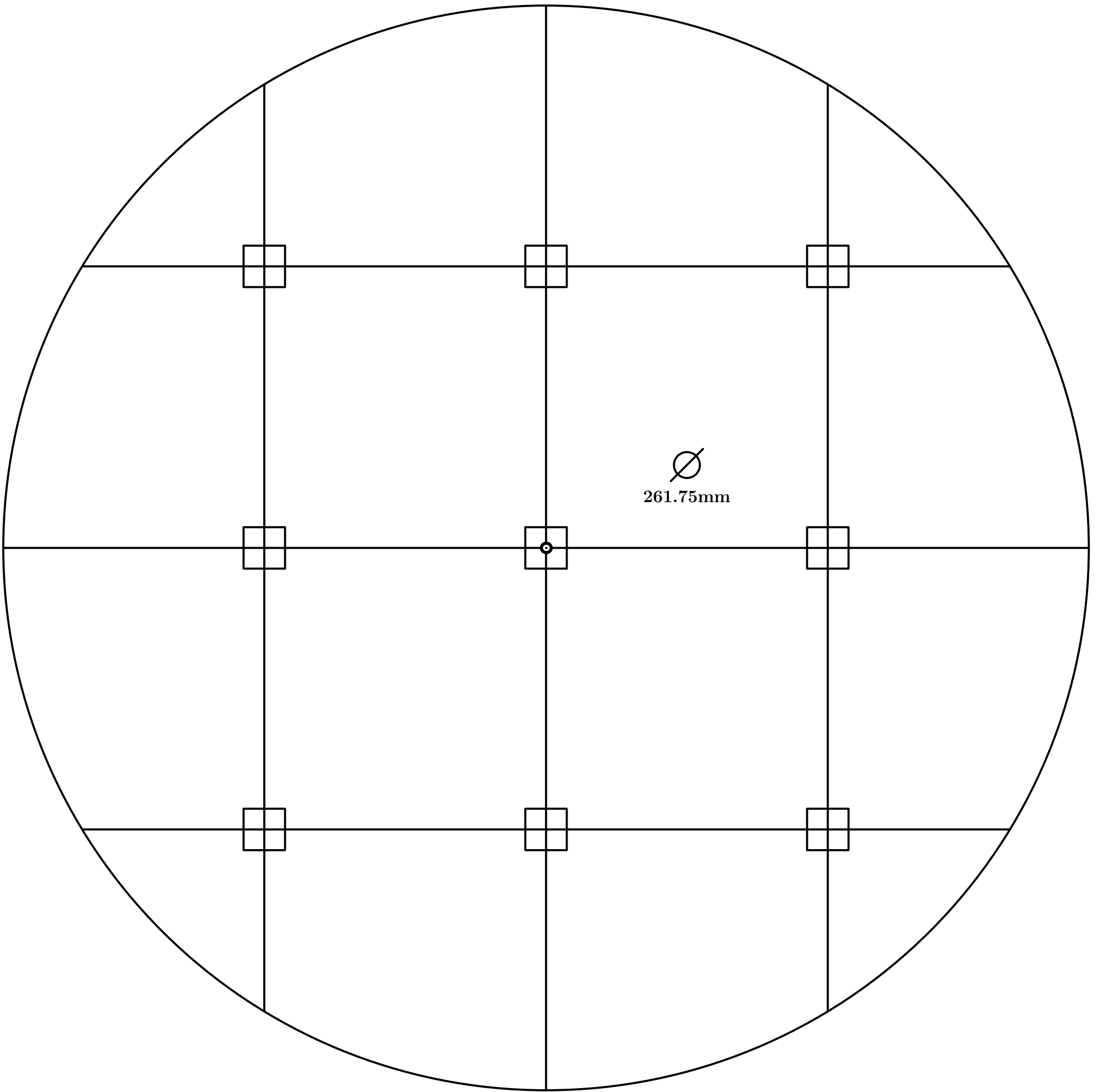

Fig. 648

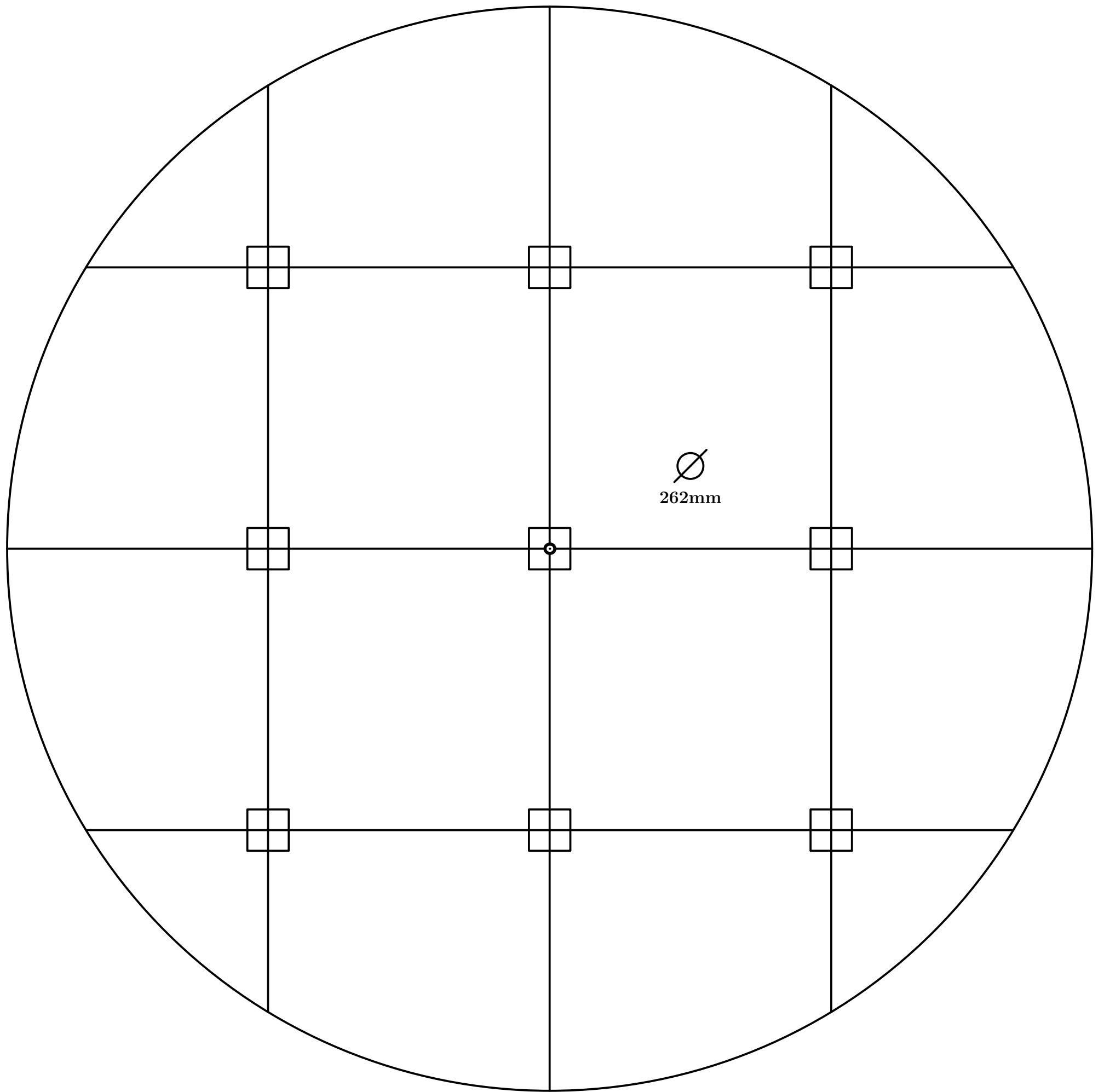

Fig. 649

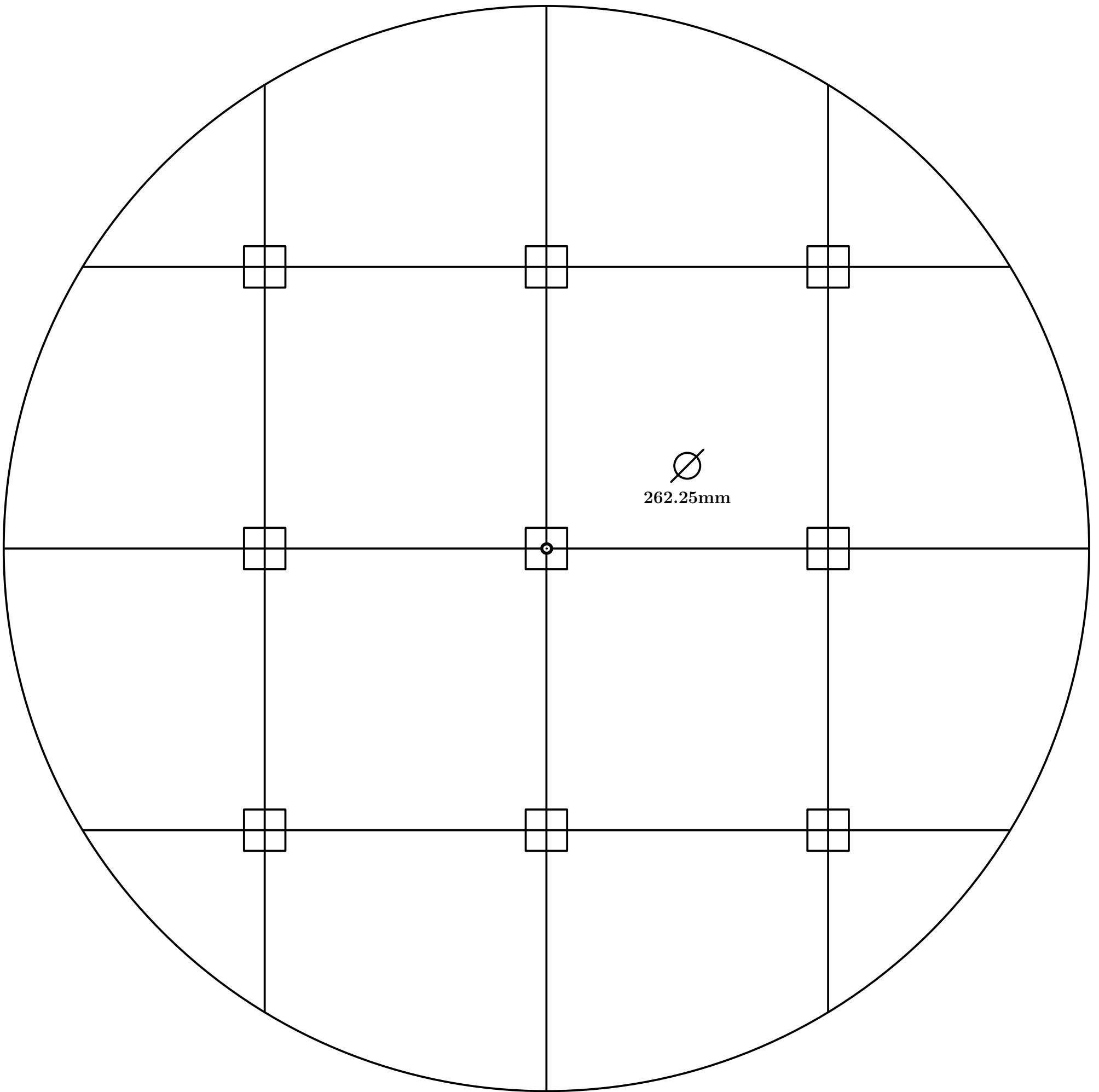

Fig. 650

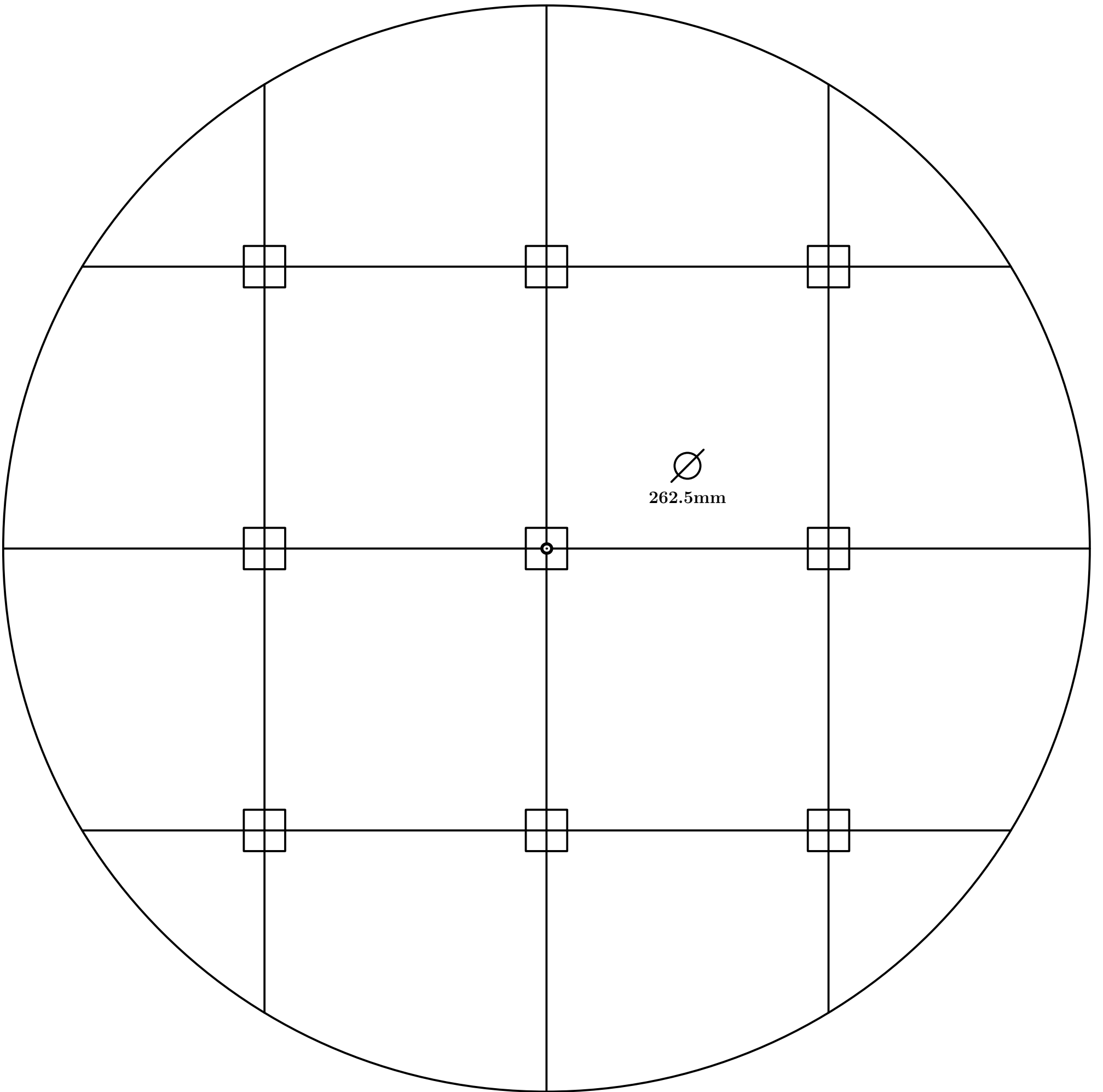

Fig. 651

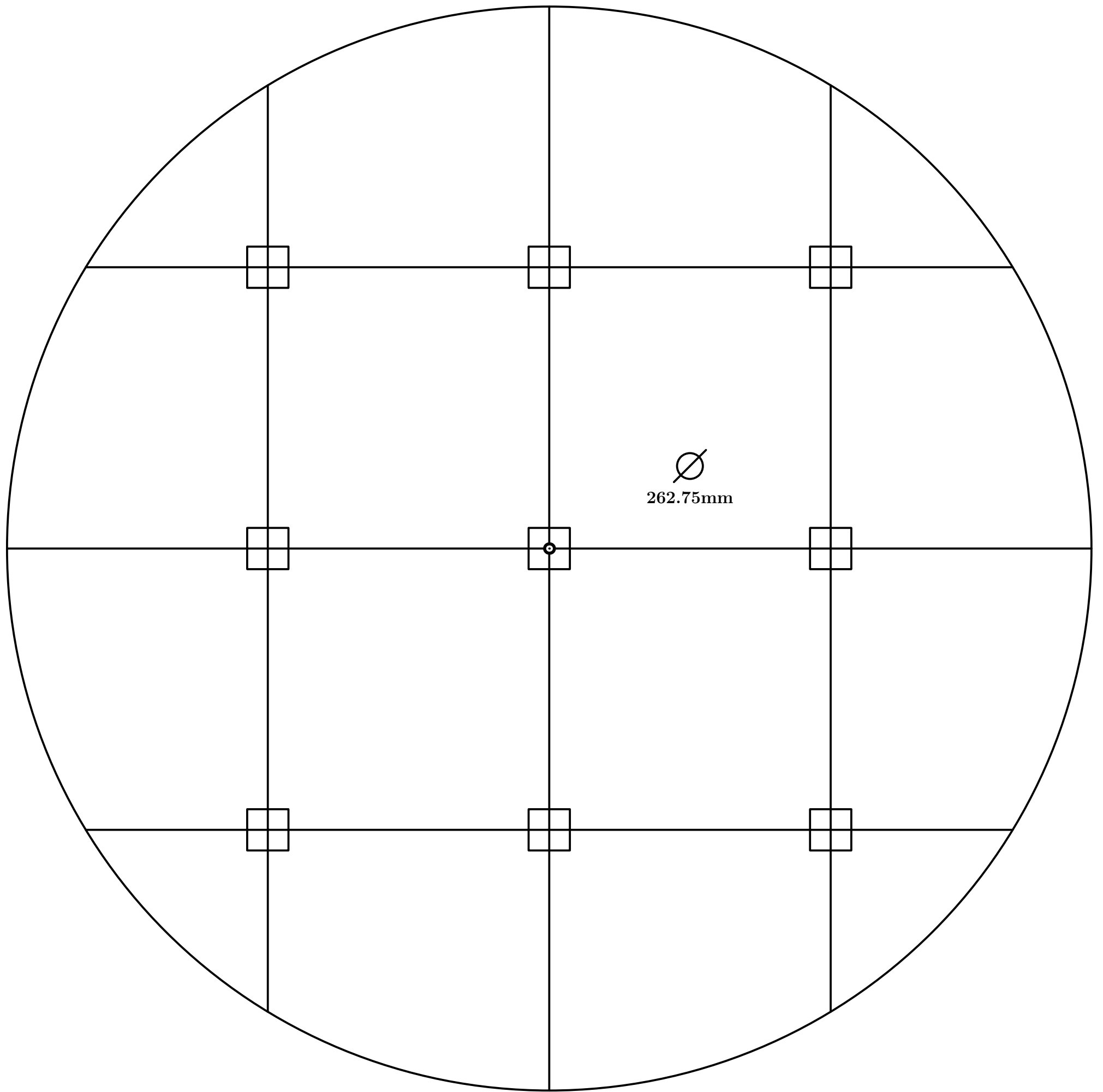

Fig. 652

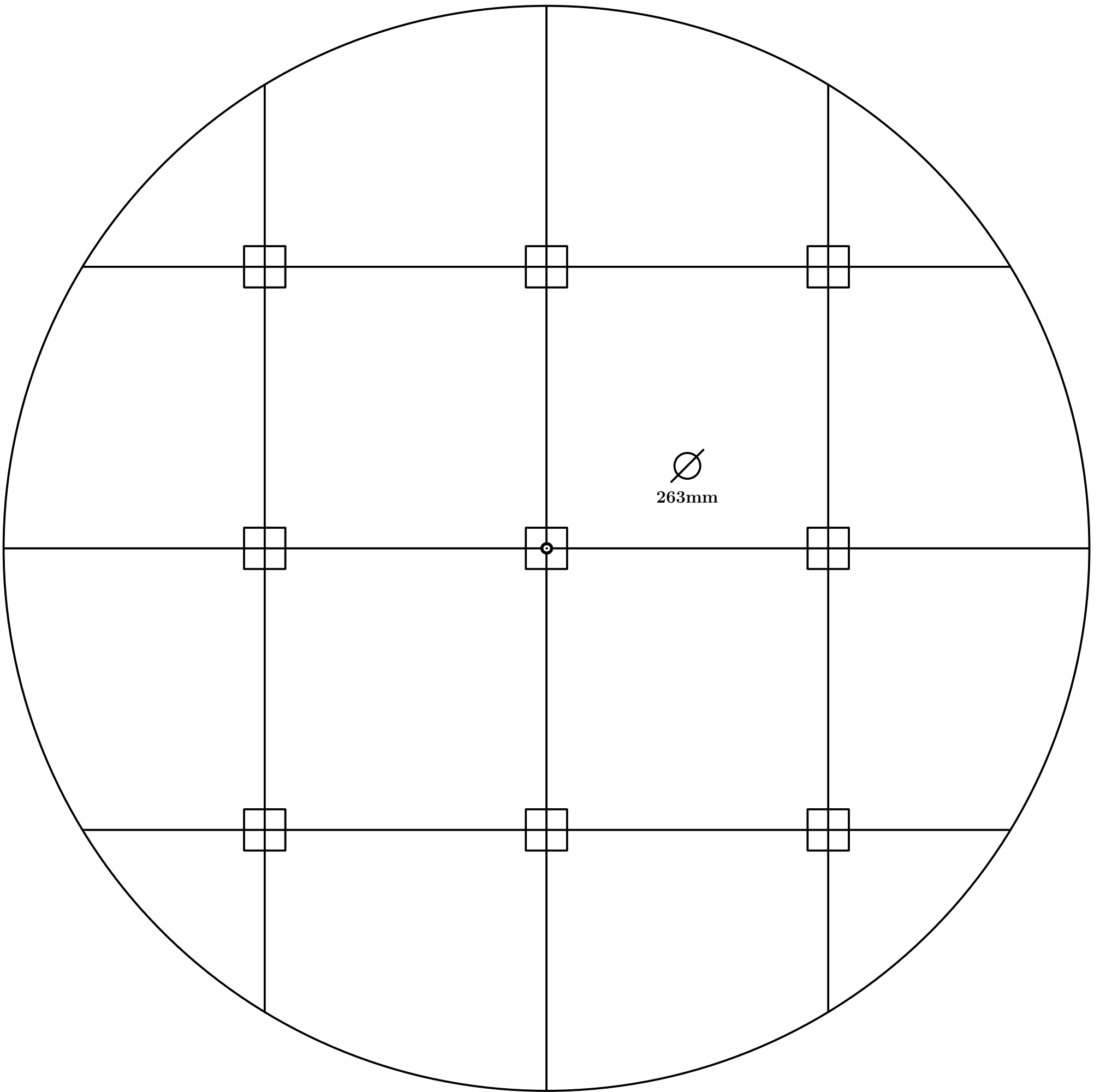

Fig. 653

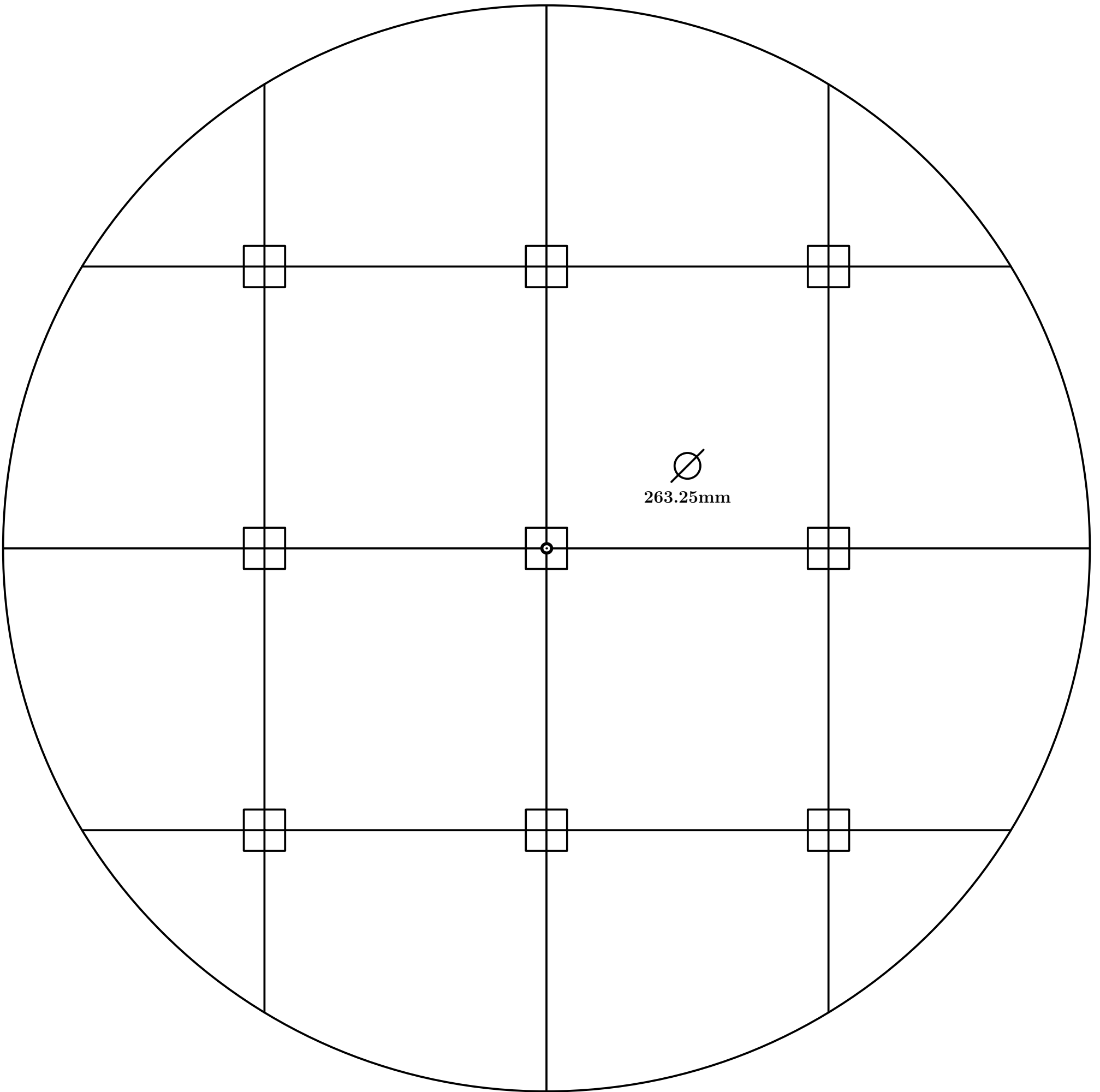

Fig. 654

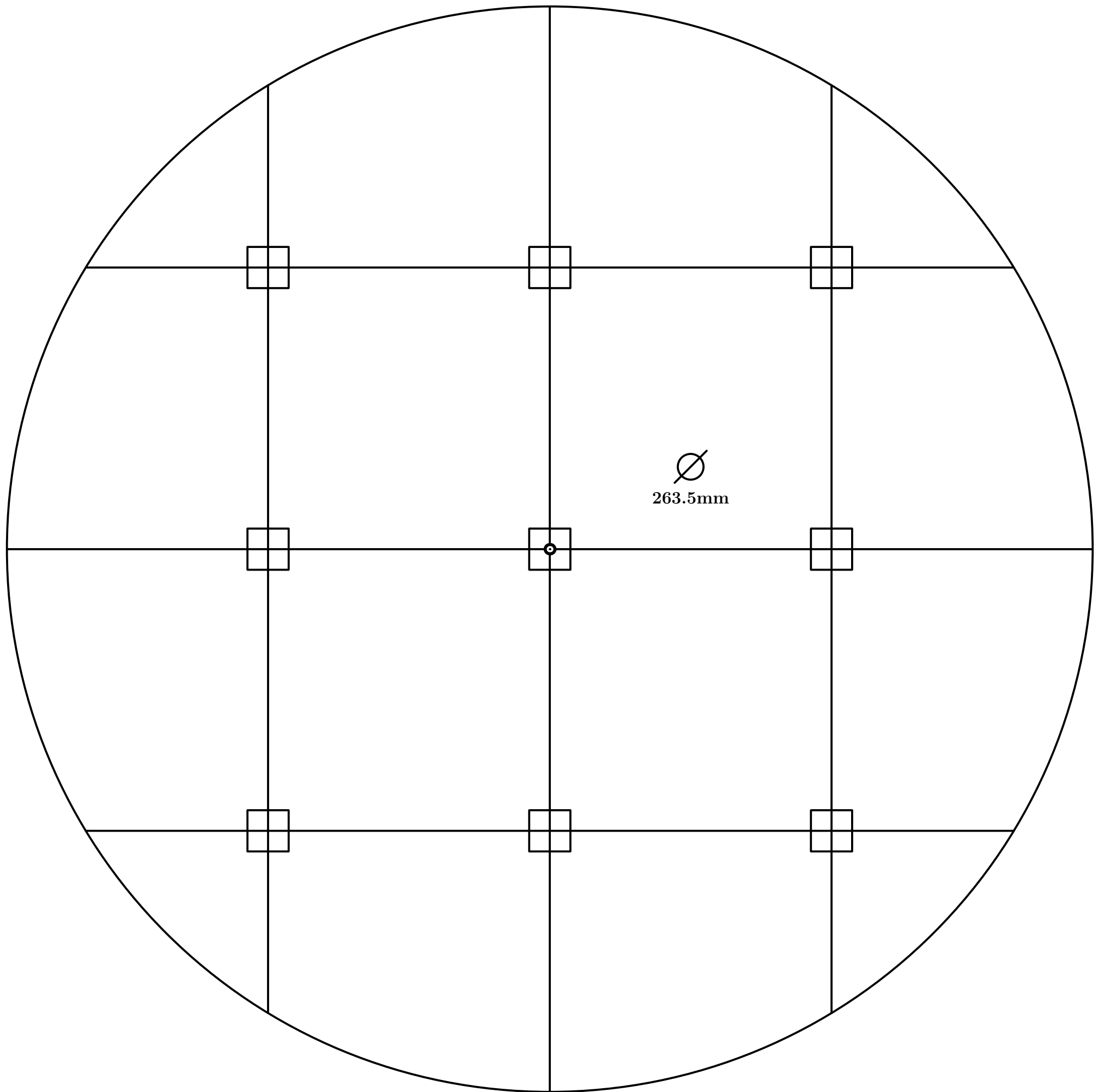

Fig. 655

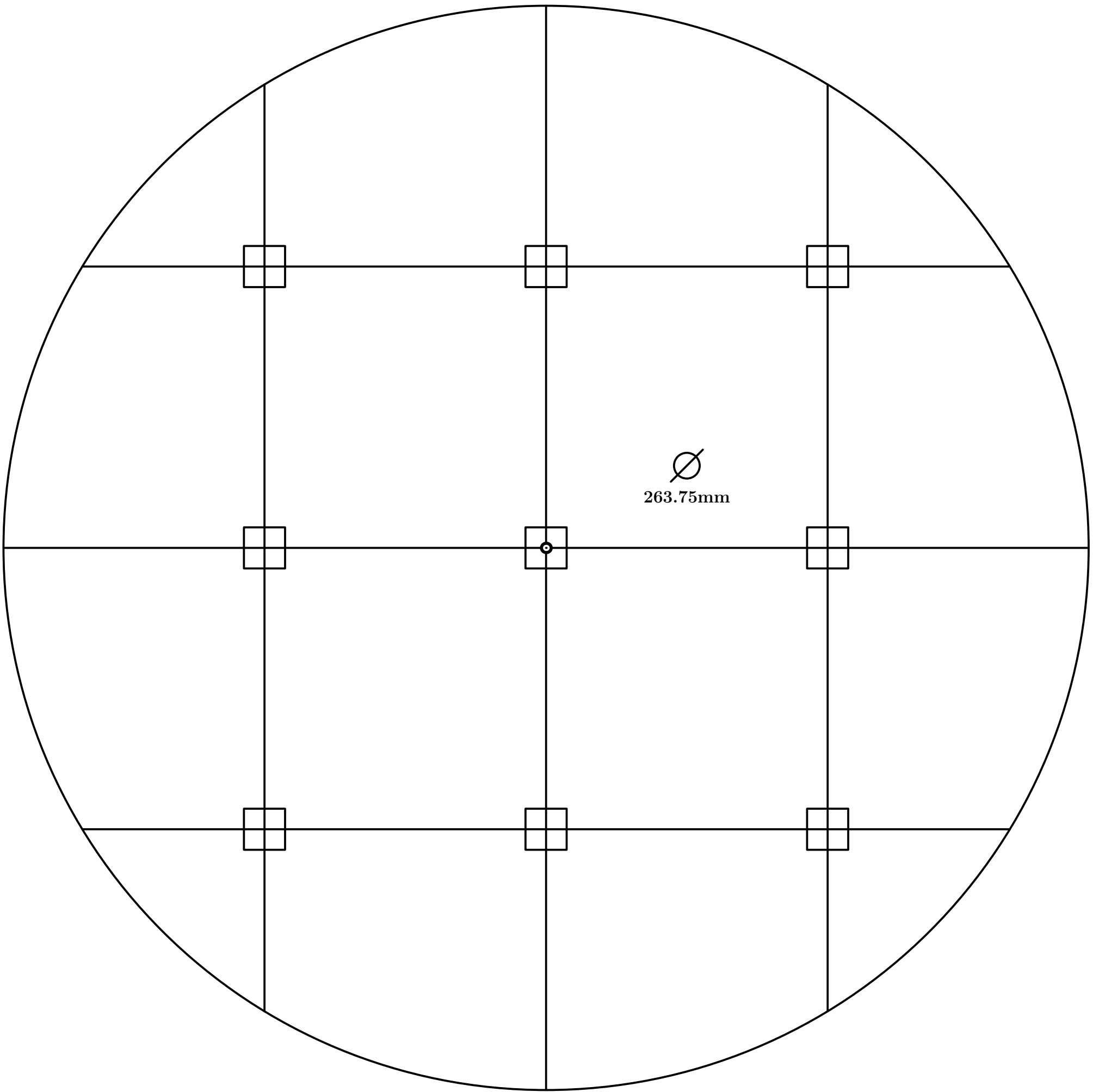

Fig. 656

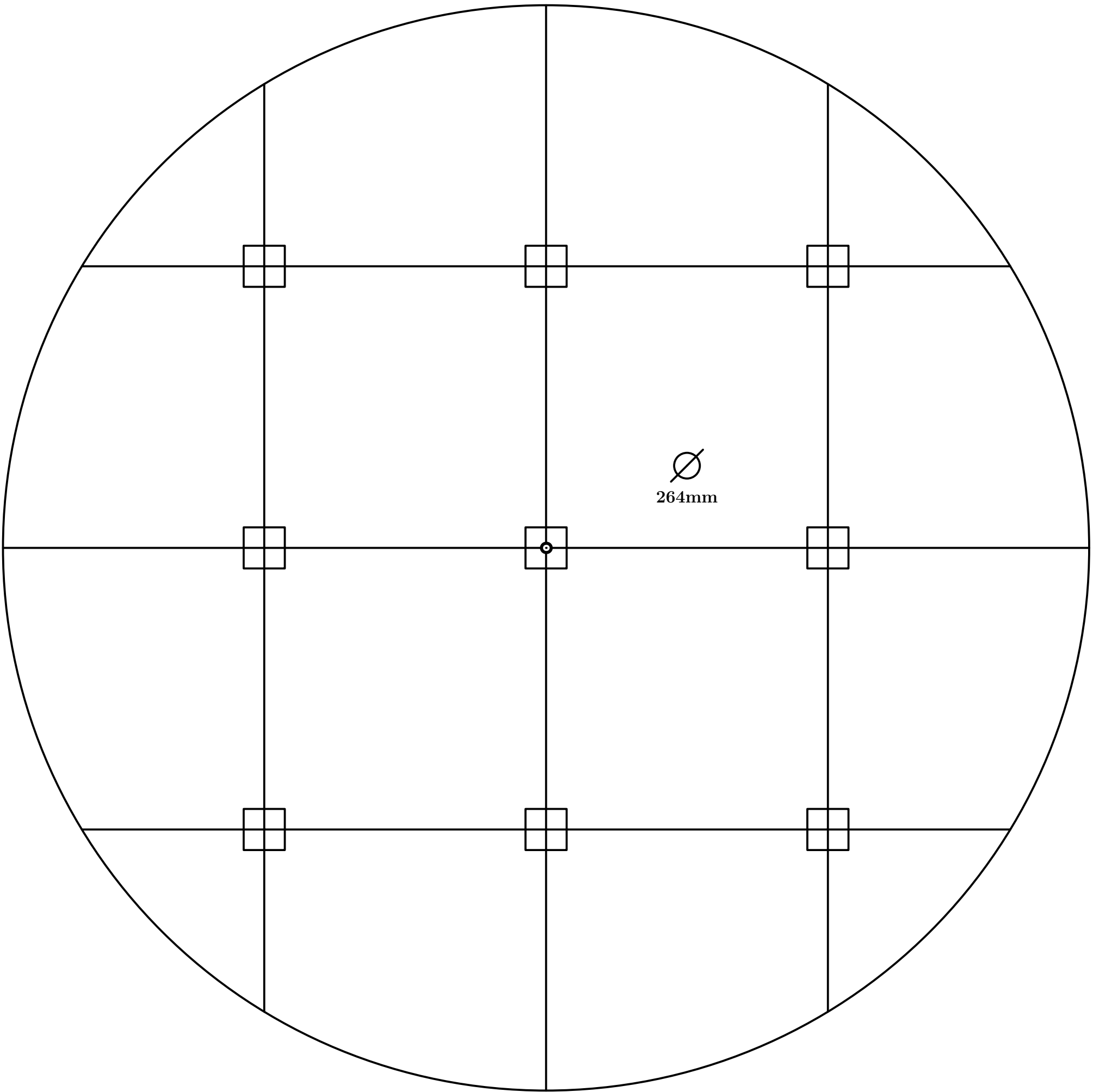

Fig. 657

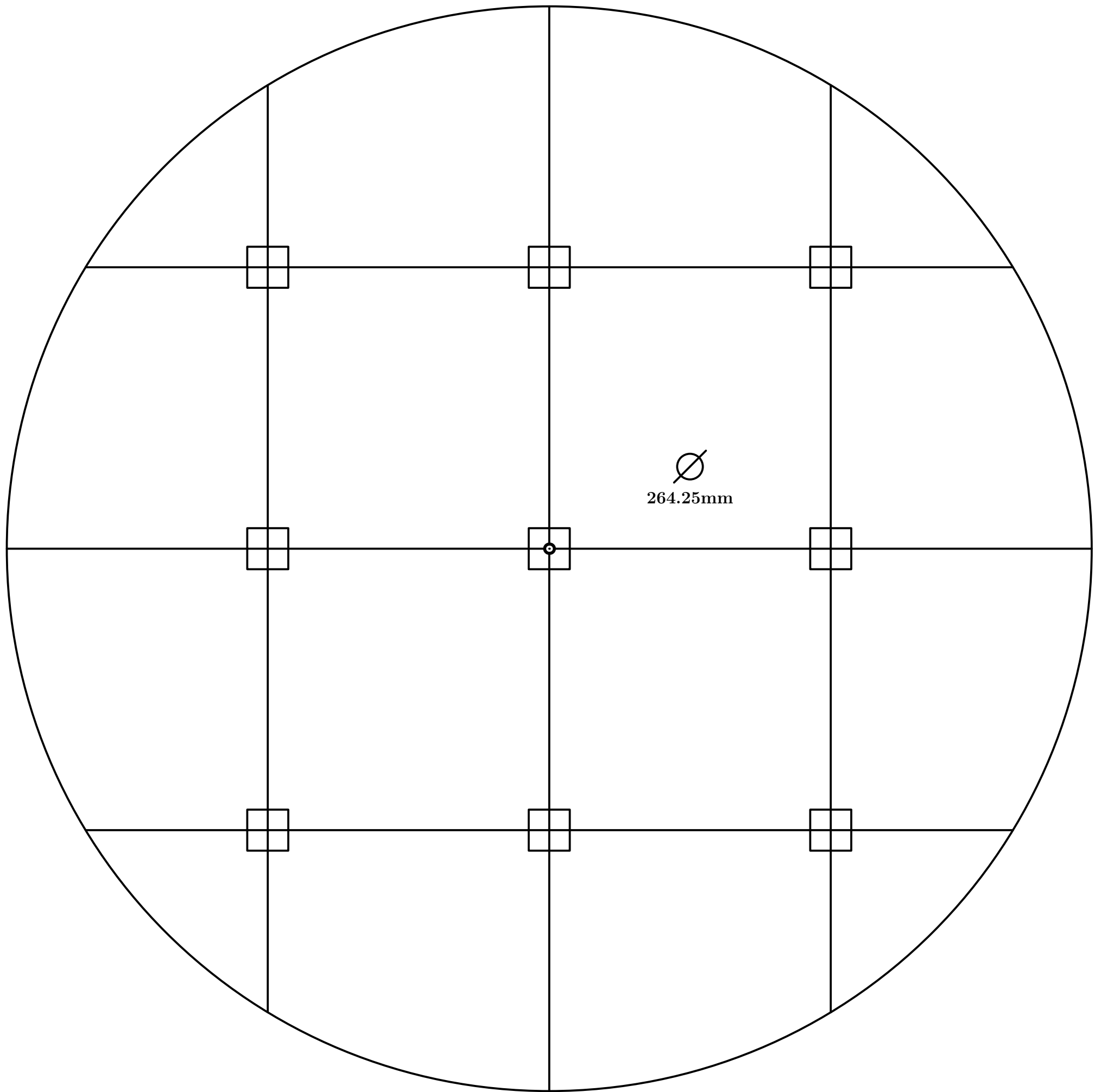

Fig. 658

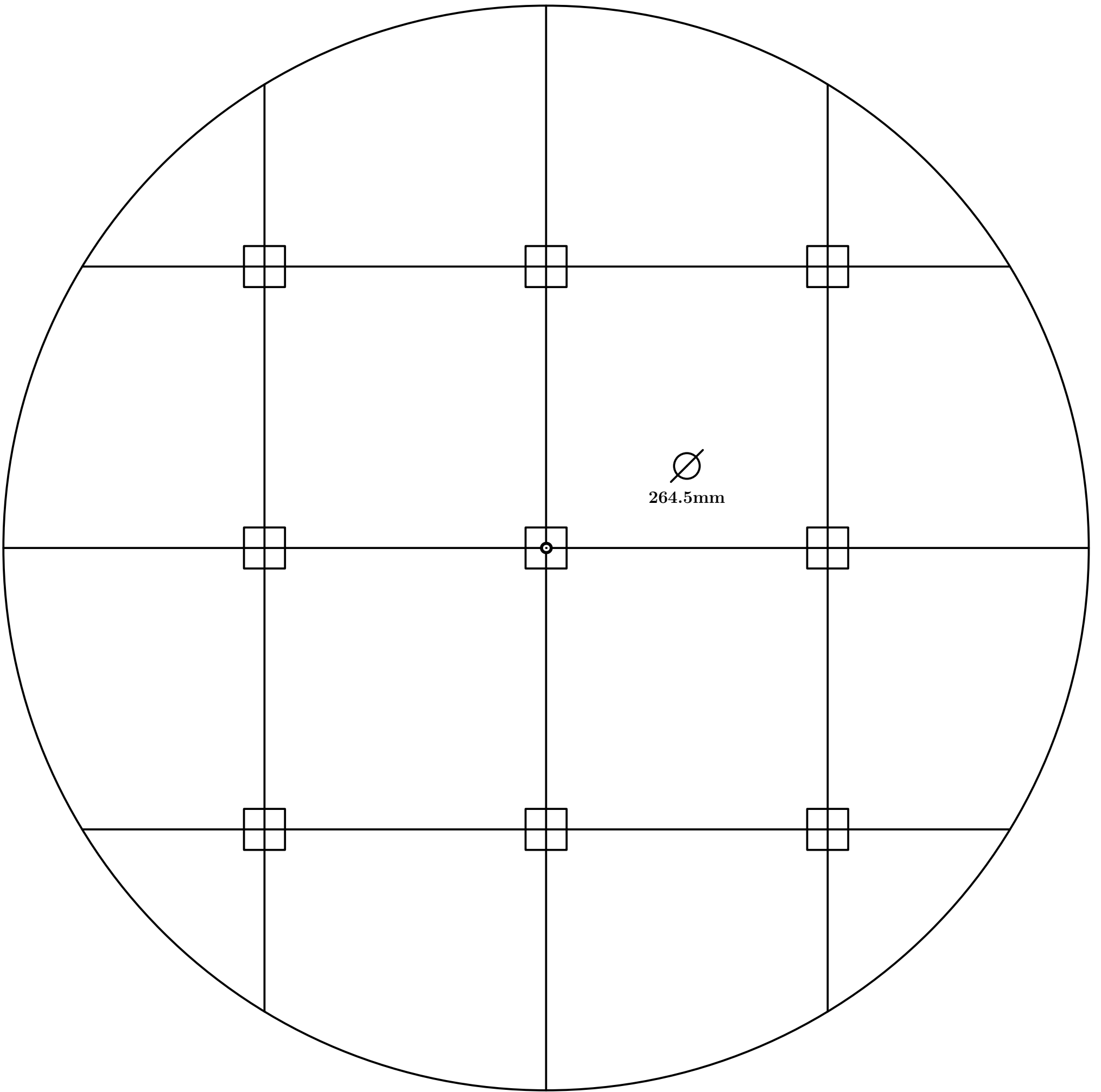

Fig. 659

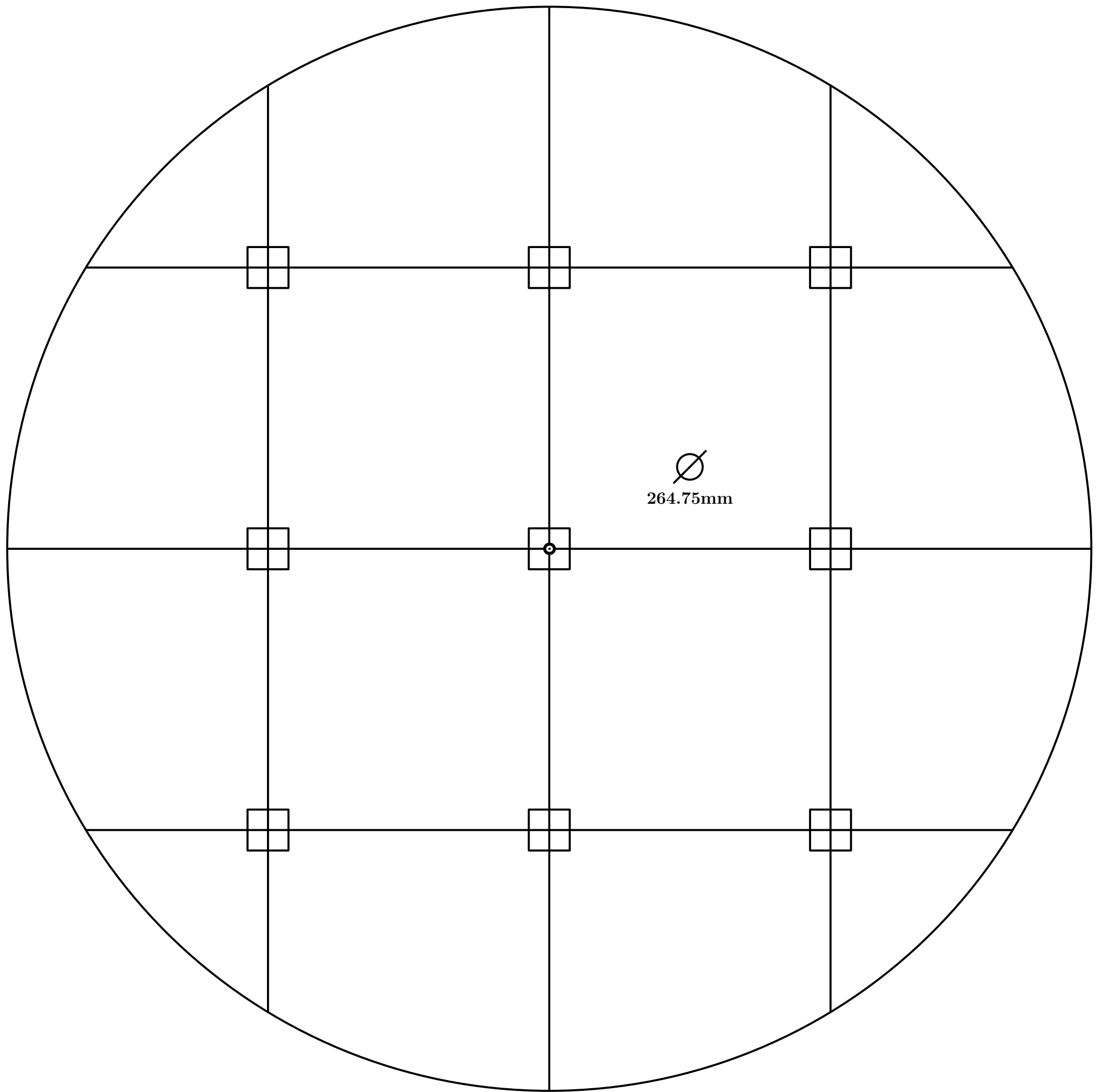

Fig. 660

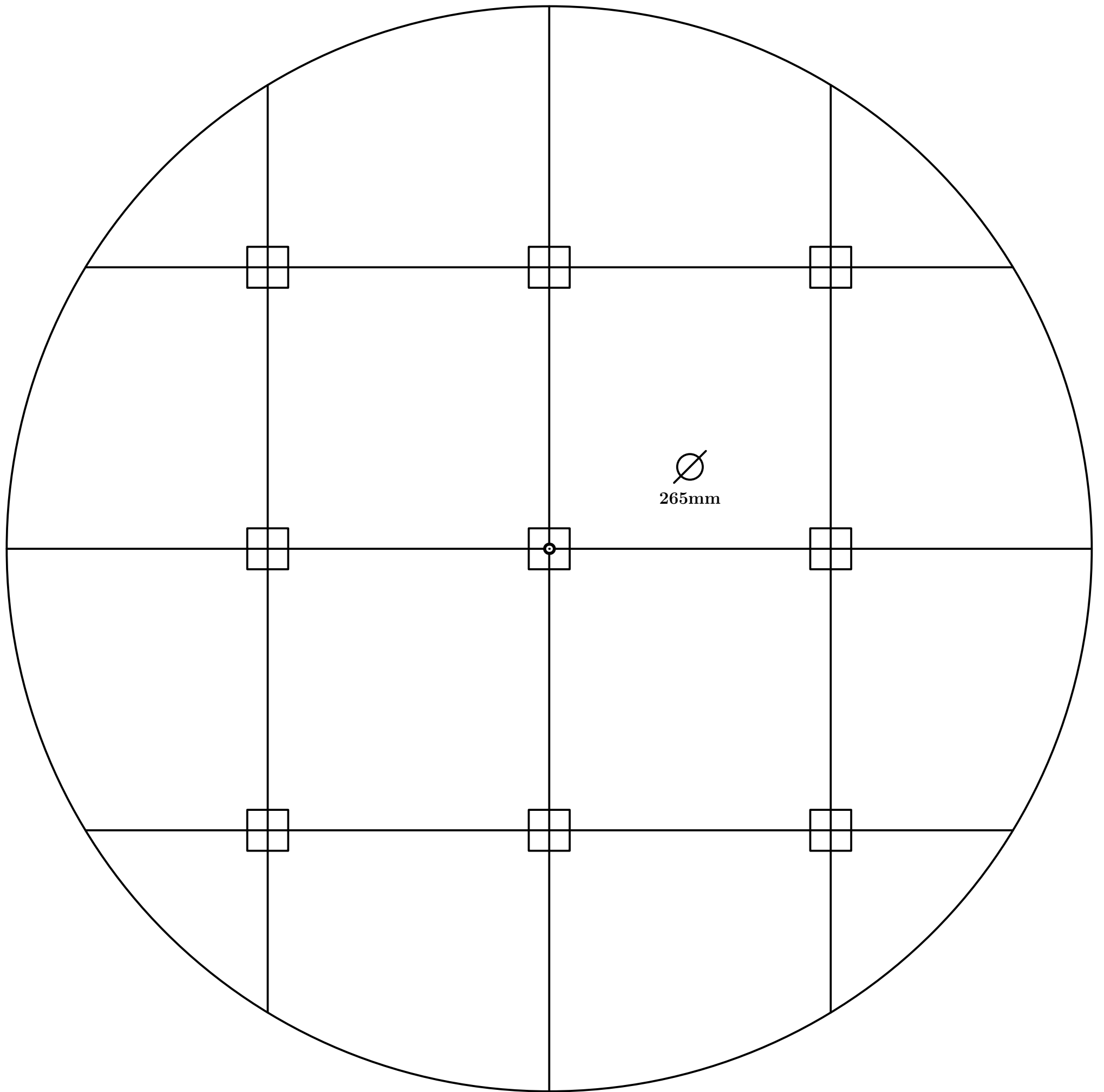

Fig. 661

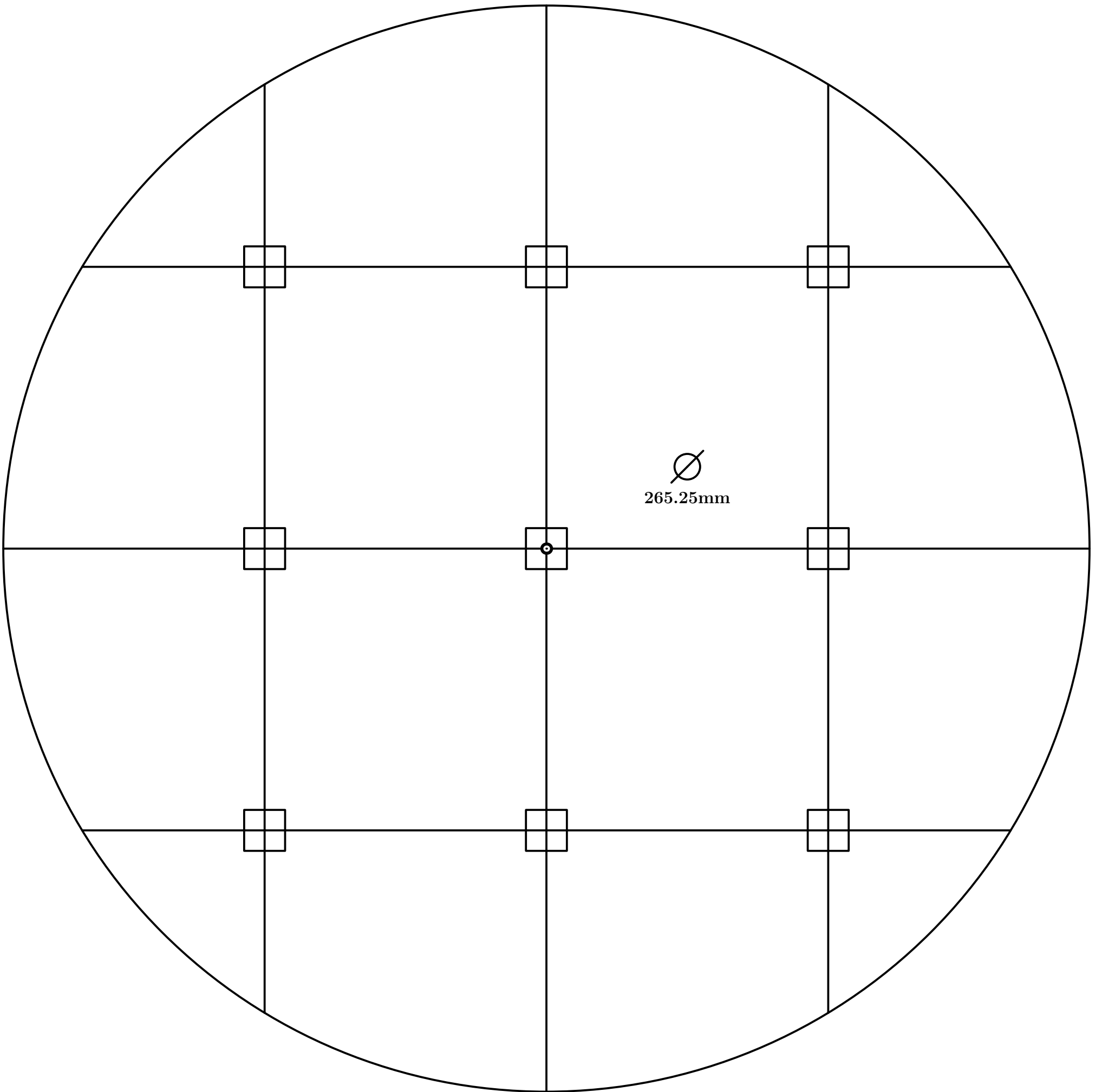

Fig. 662

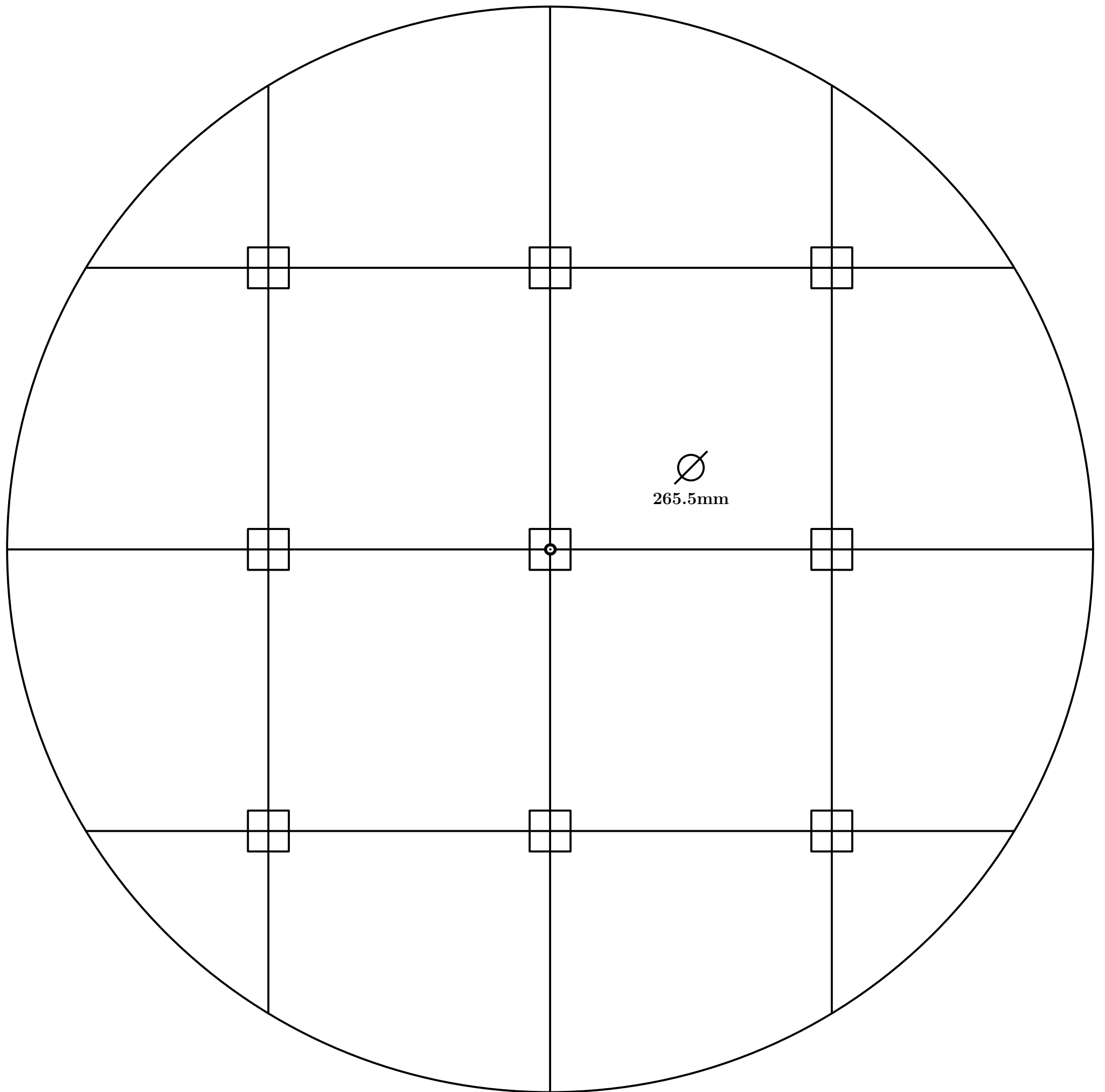

Fig. 663

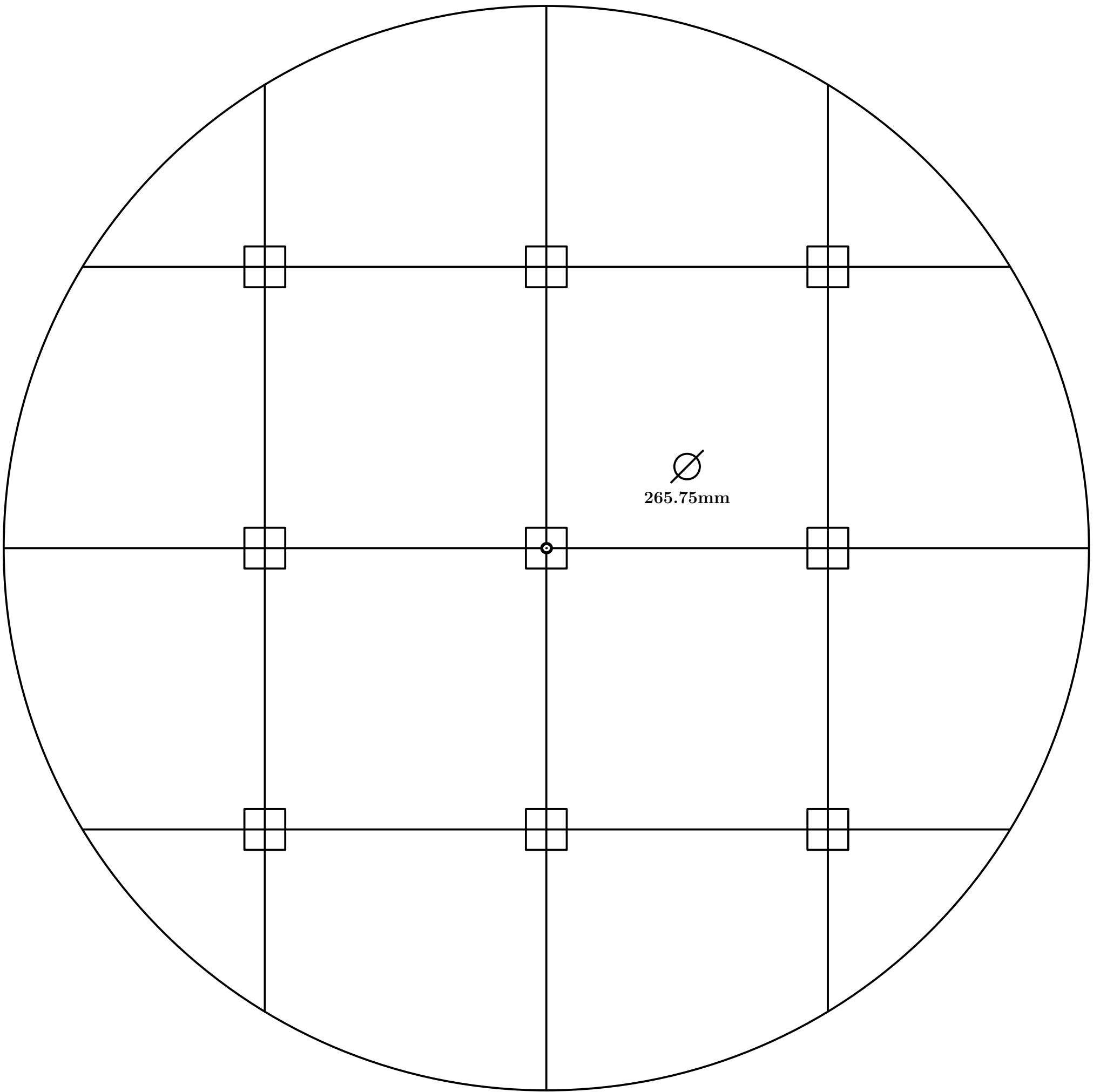

Fig. 664

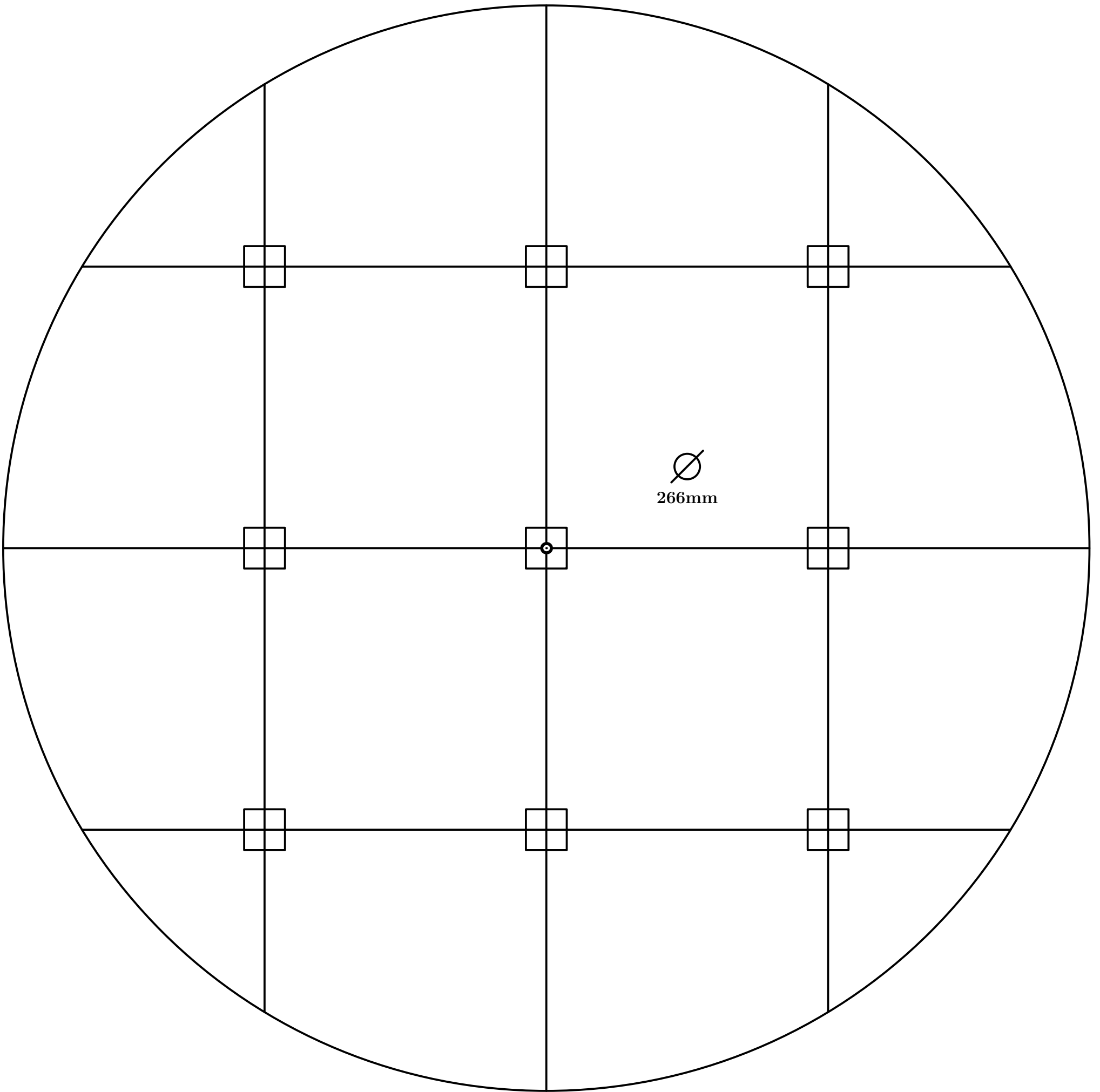

Fig. 665

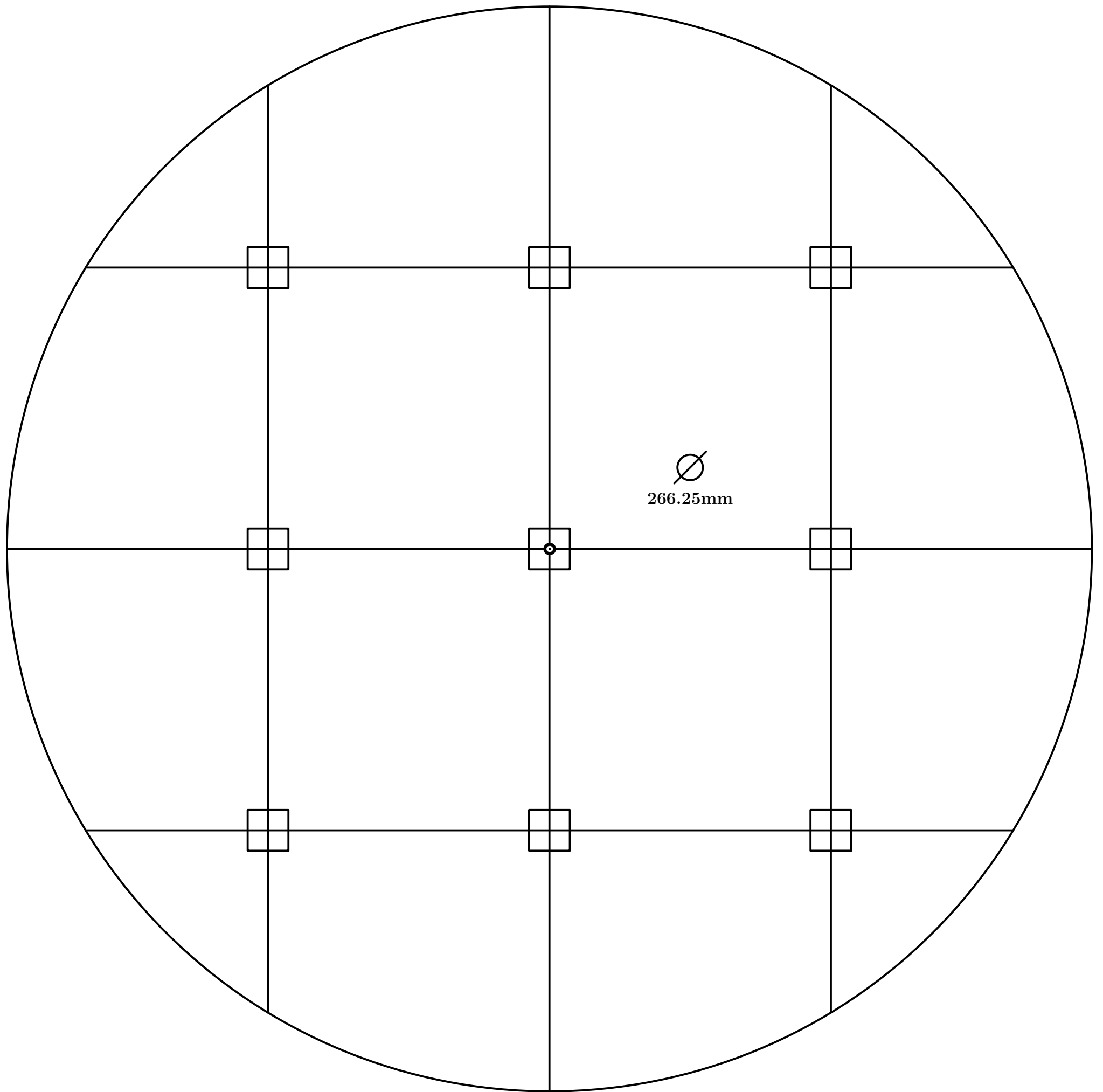

Fig. 666

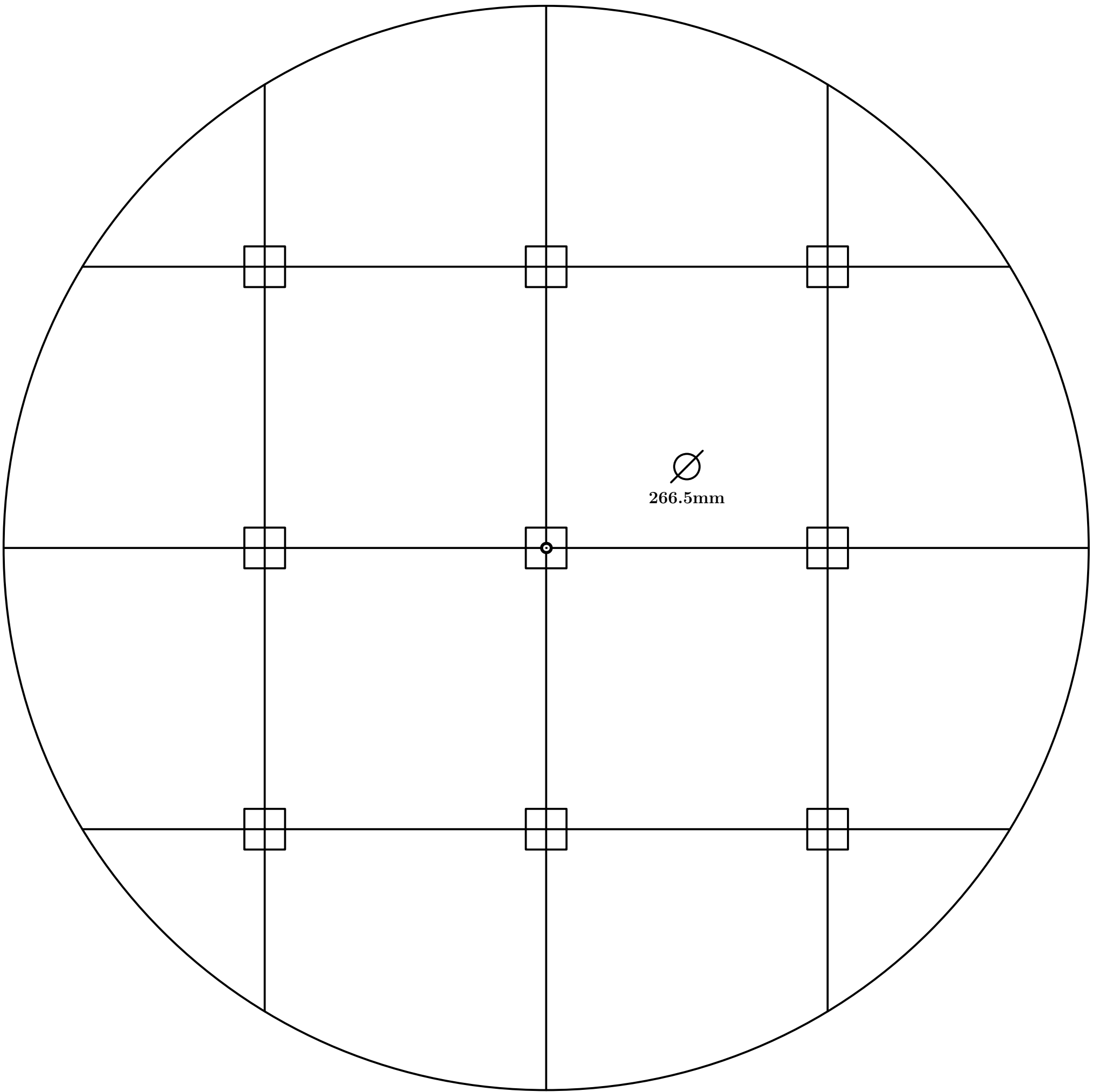

Fig. 667

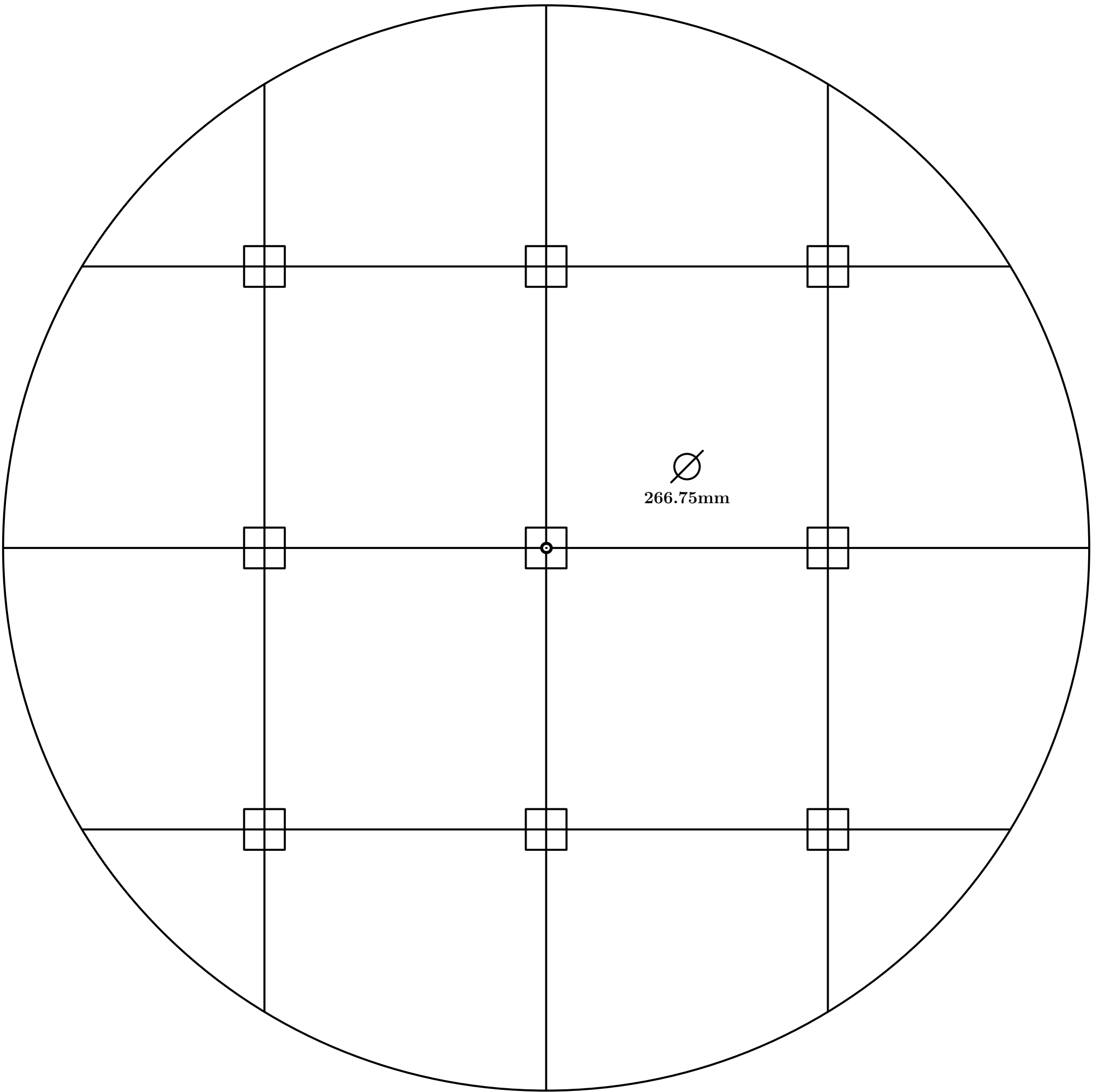

Fig. 668

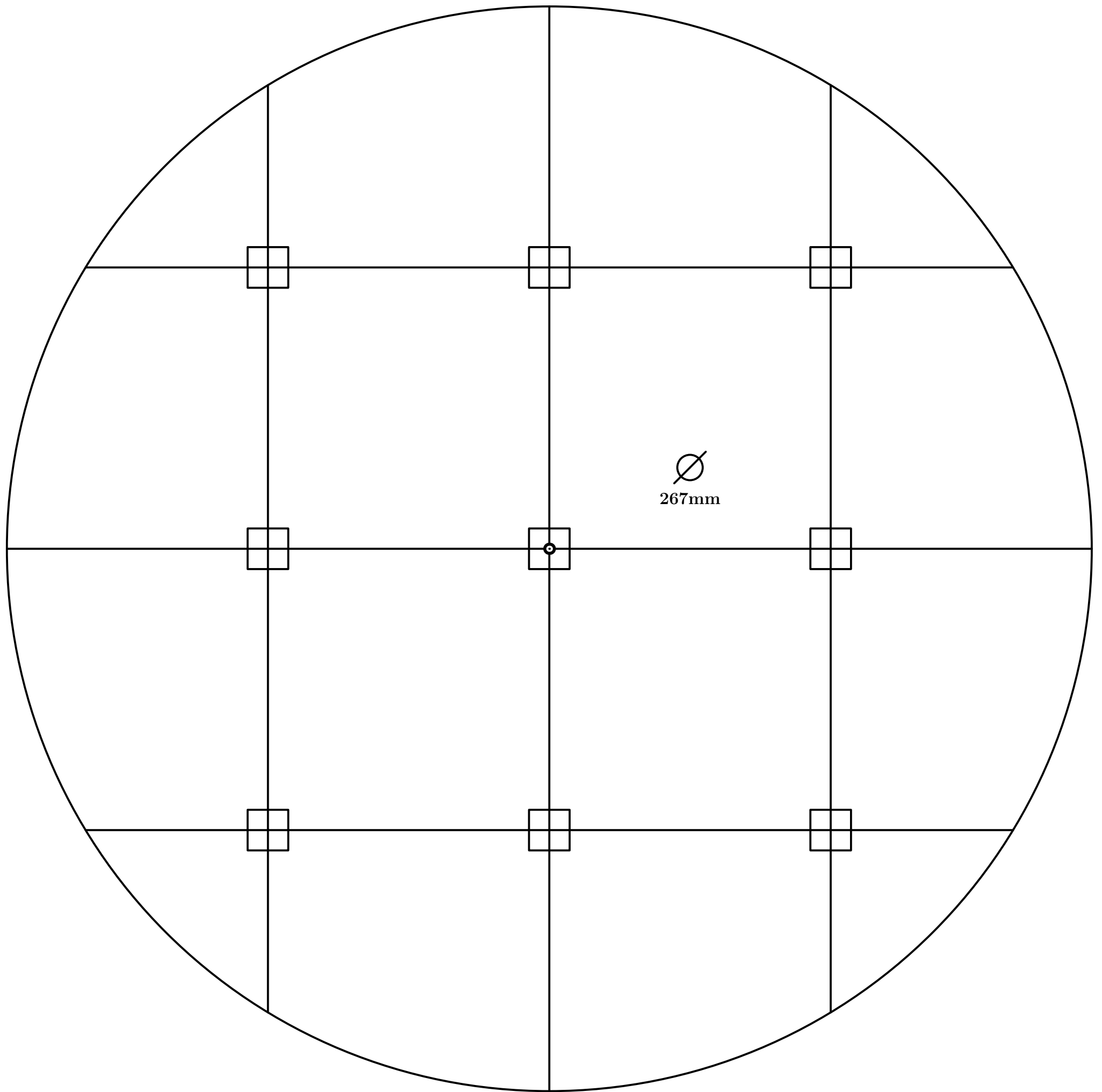

Fig. 669

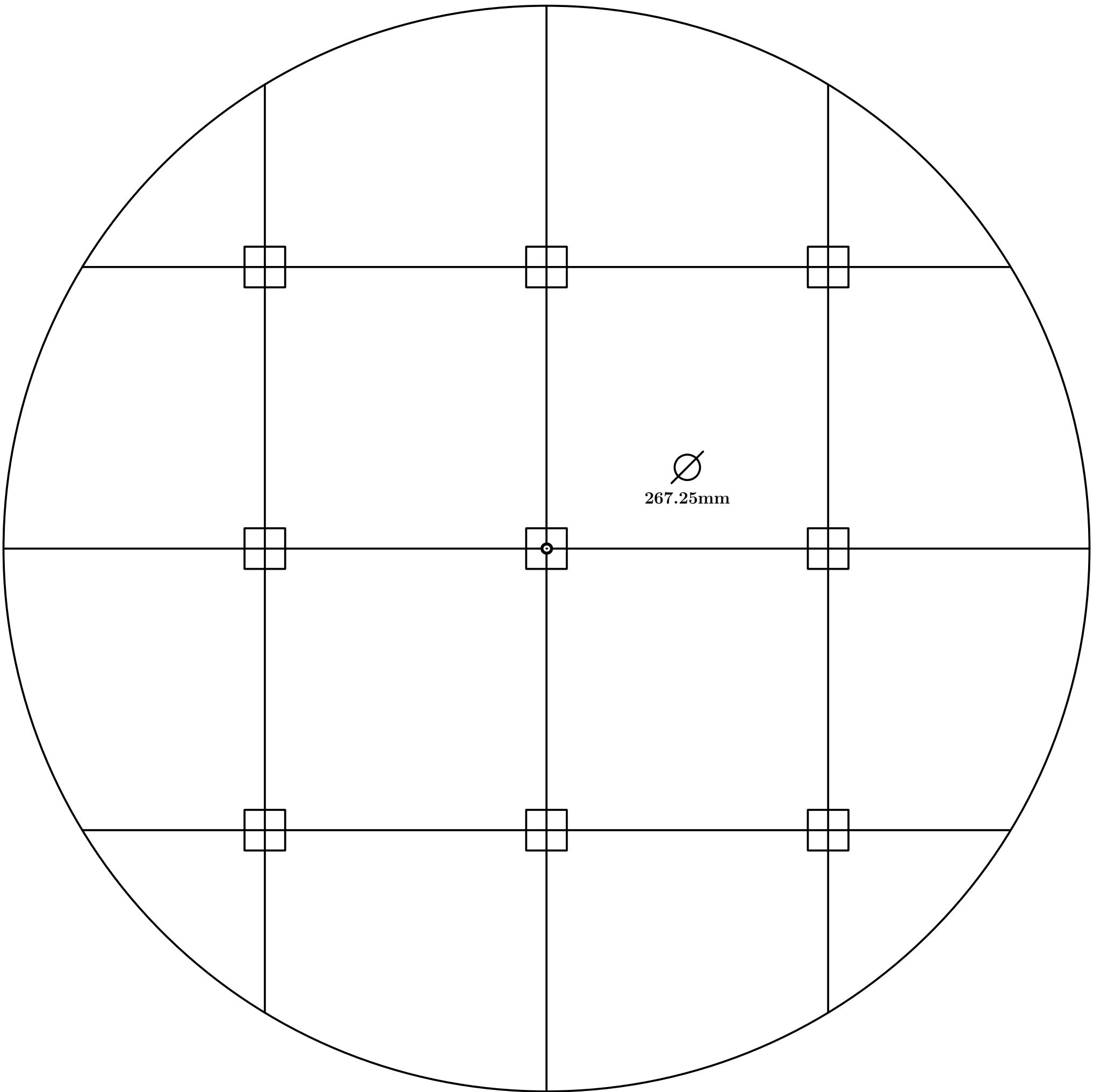

Fig. 670

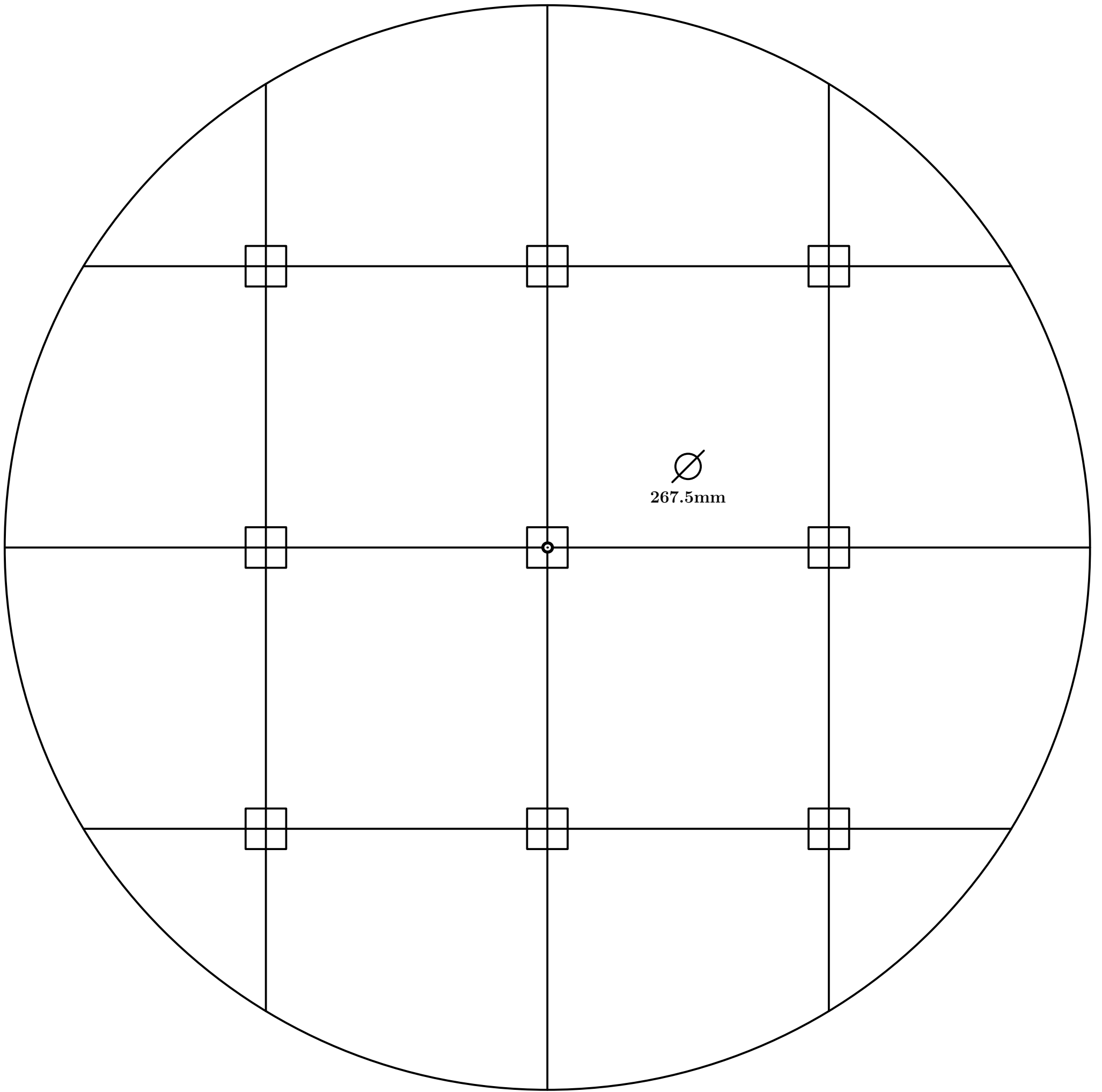

Fig. 671

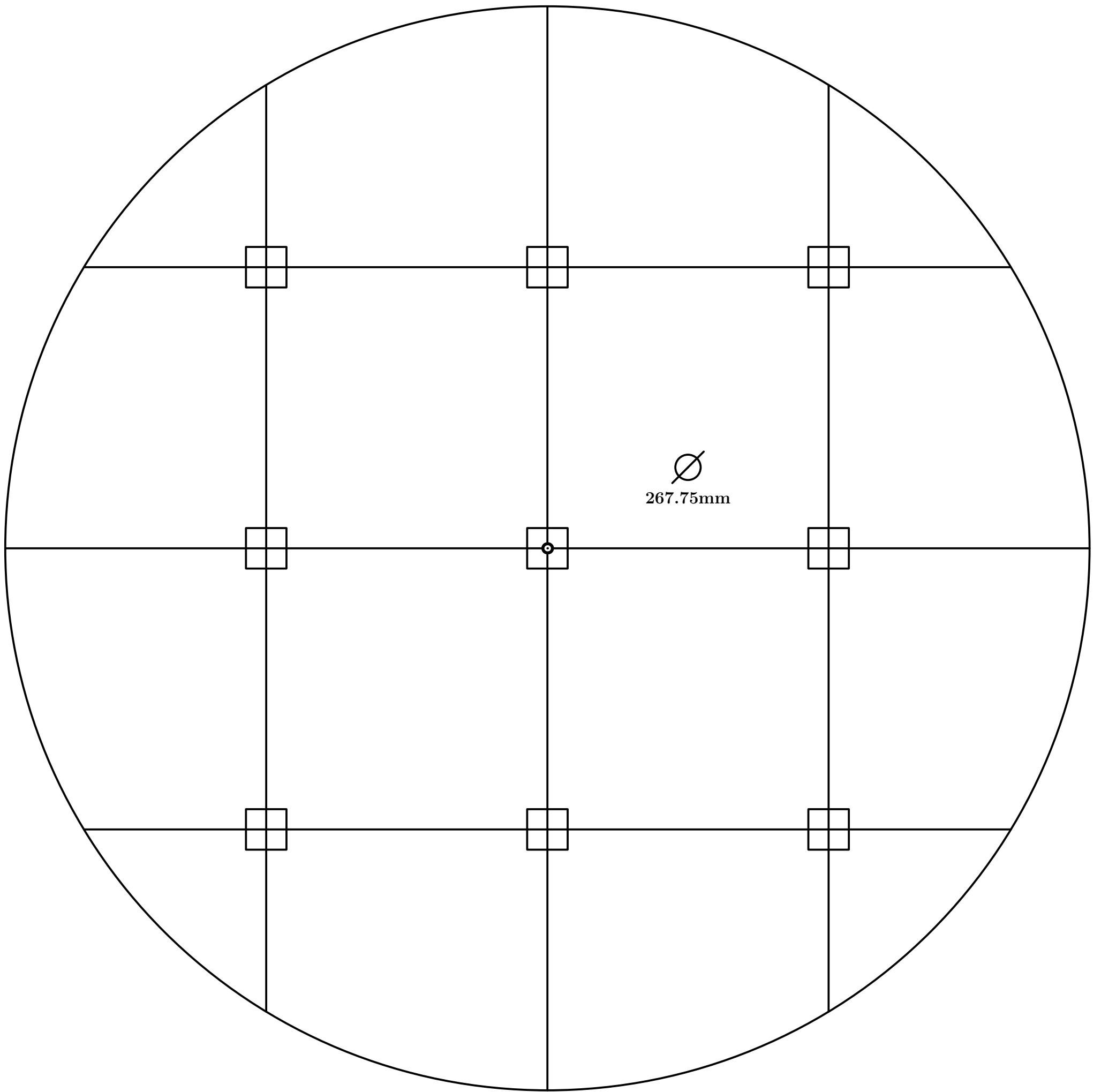

Fig. 672

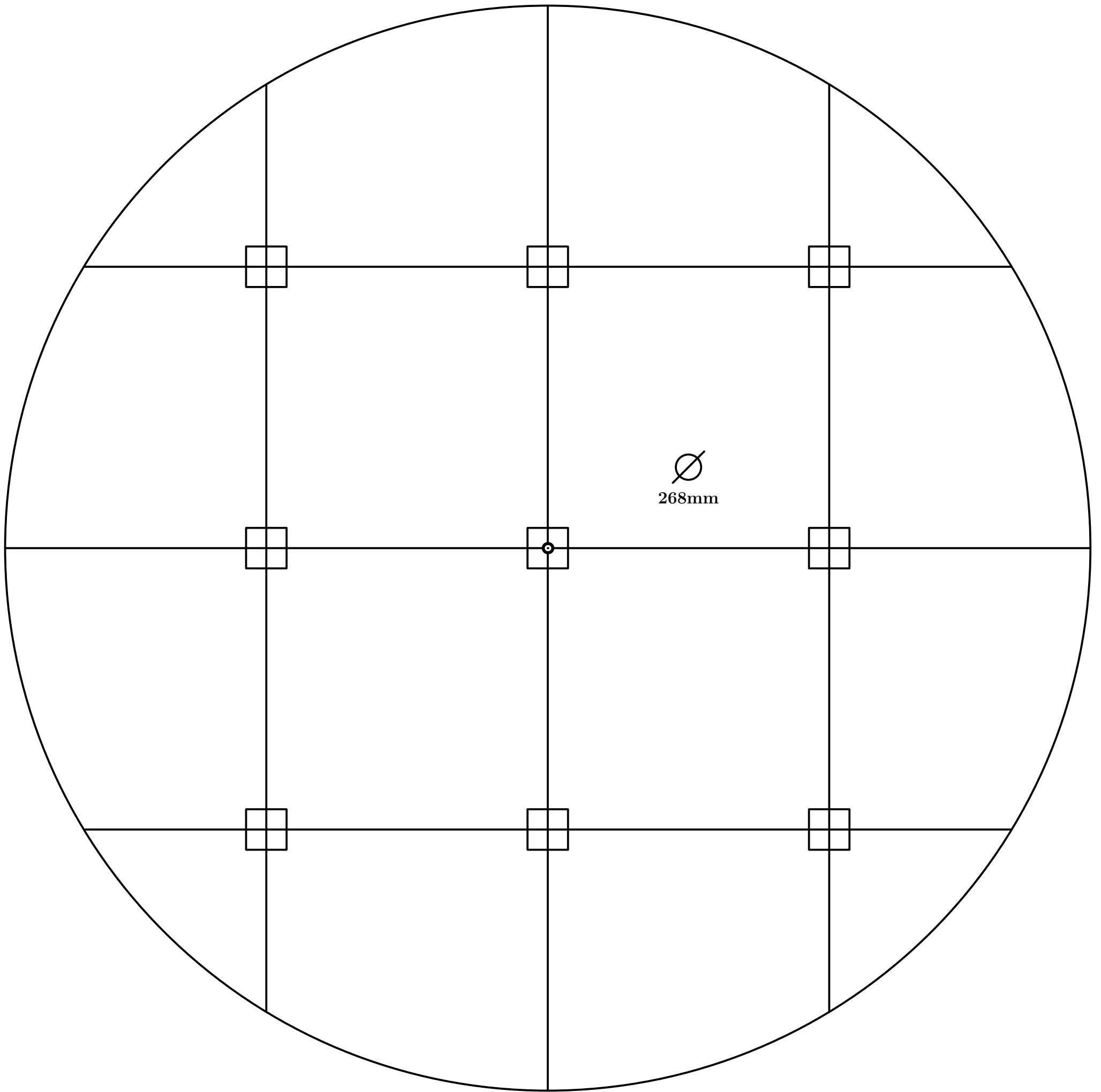

Fig. 673

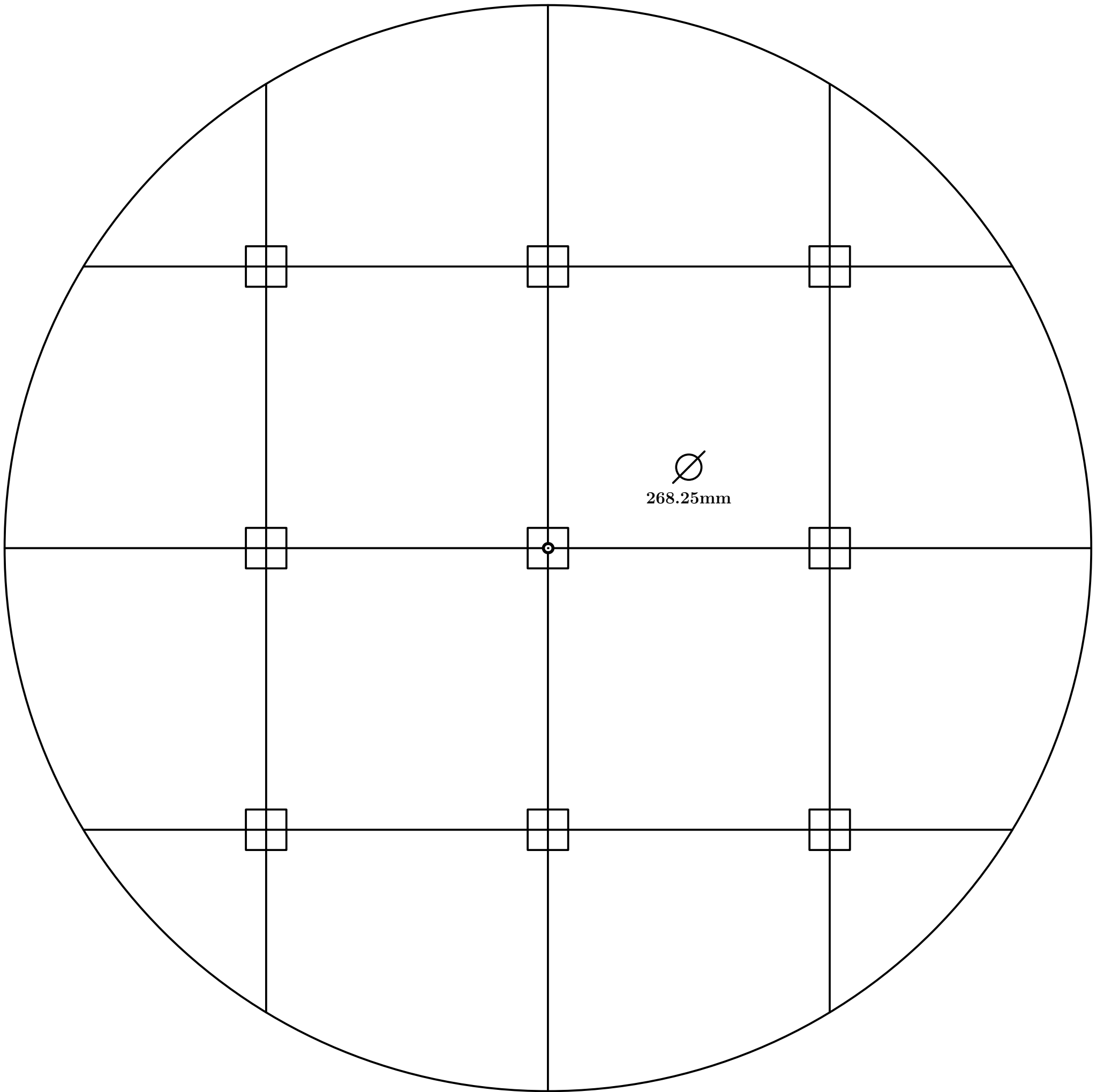

Fig. 674

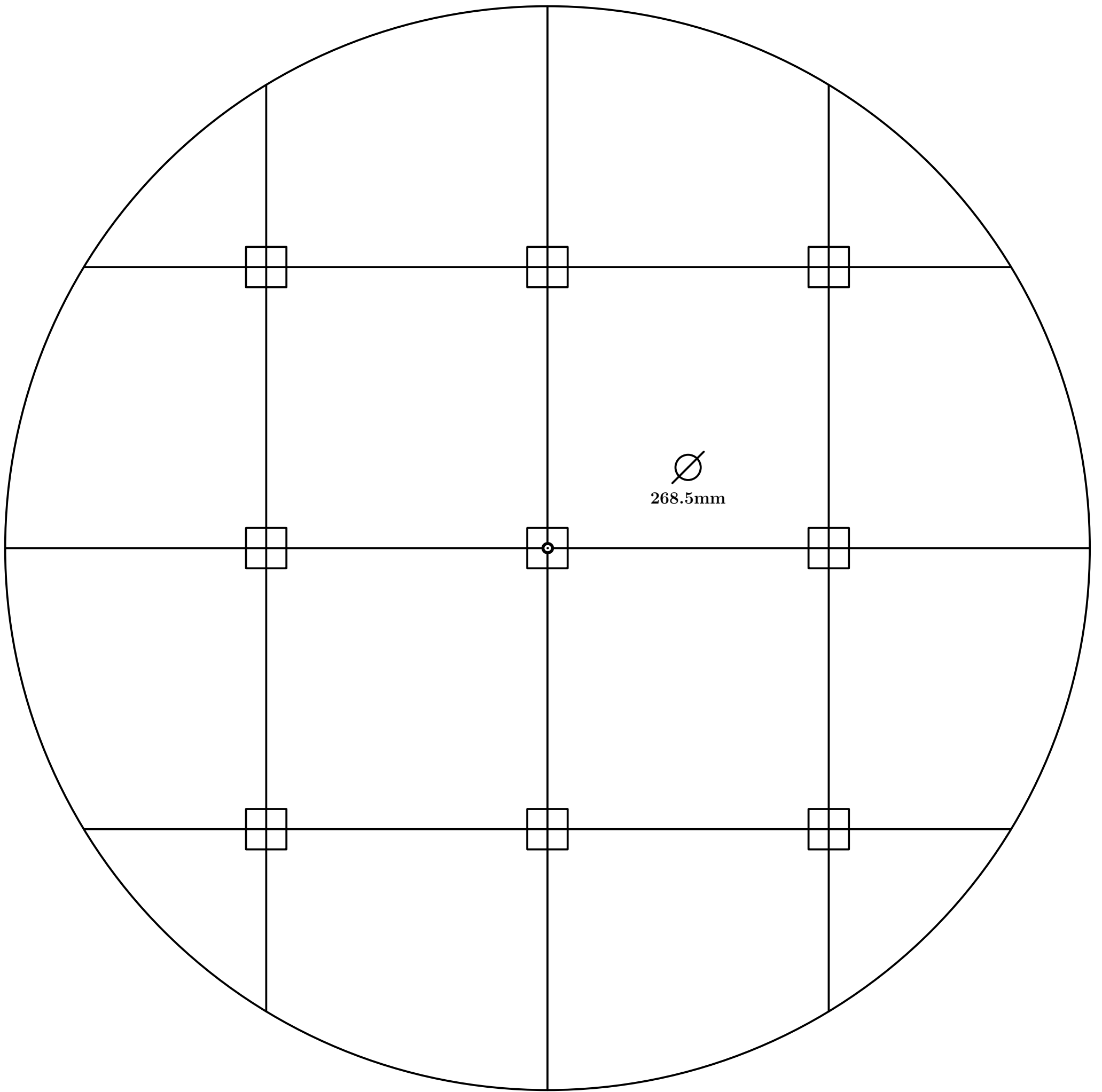

Fig. 675

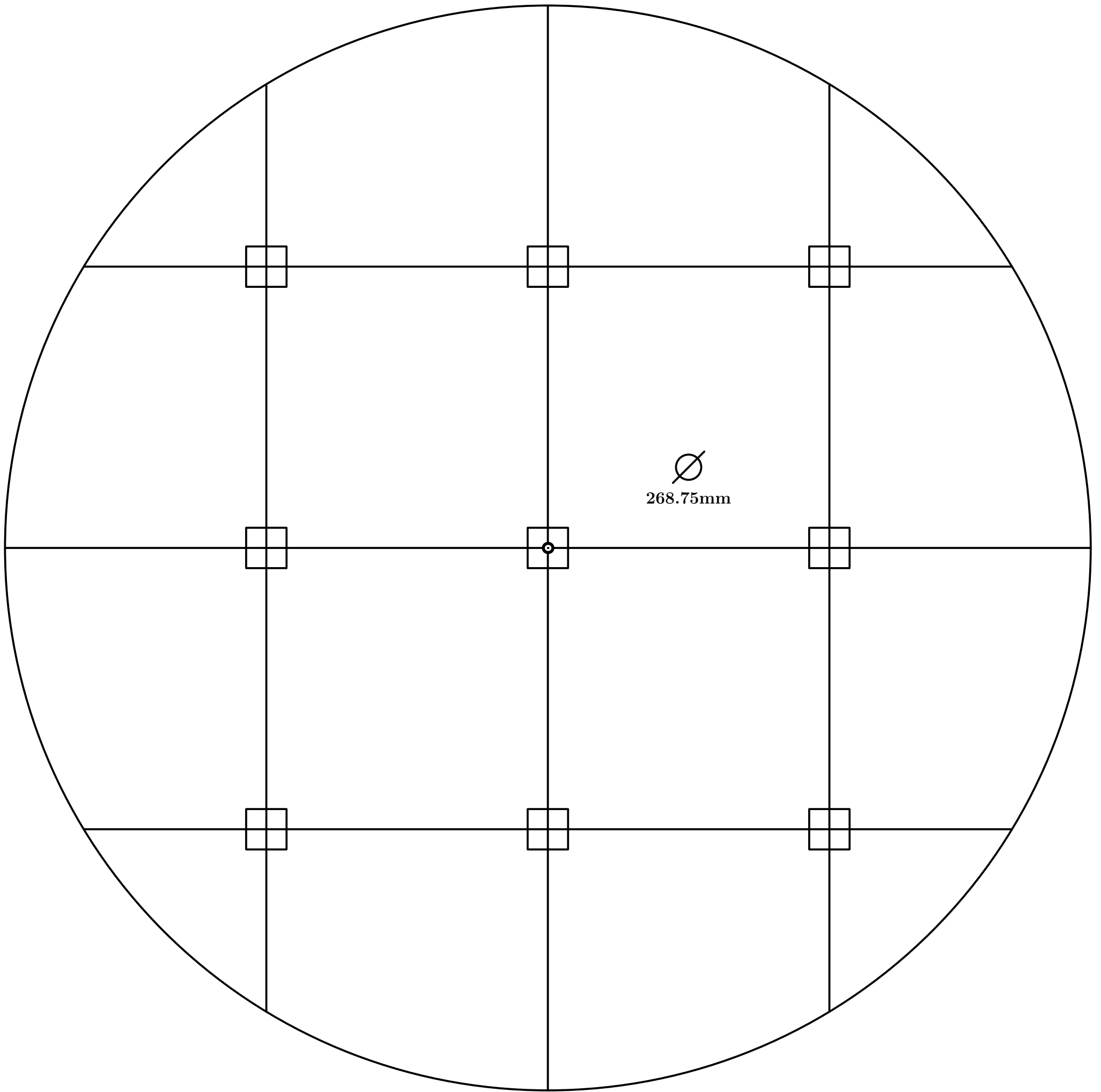

Fig. 676

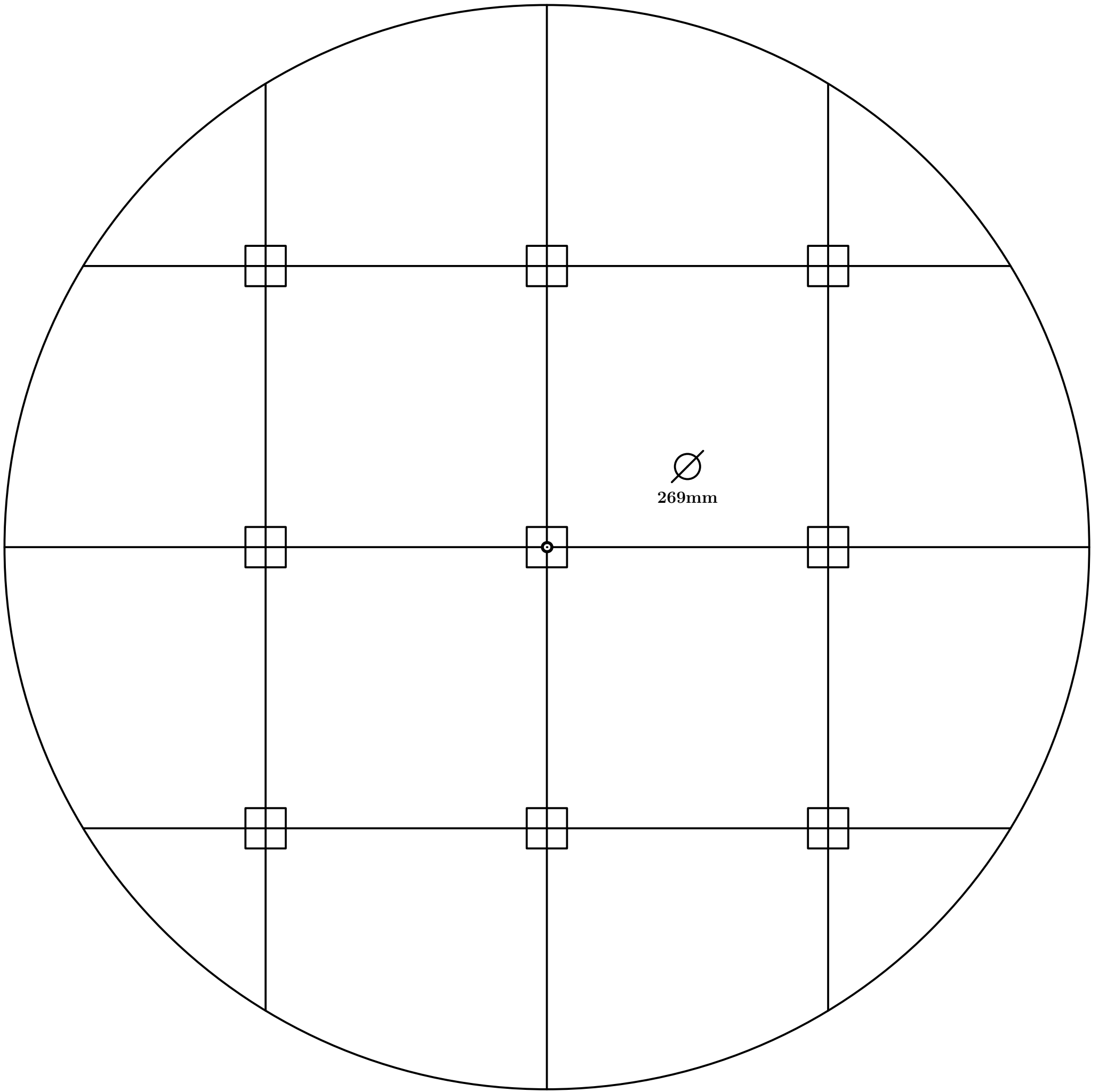

Fig. 677

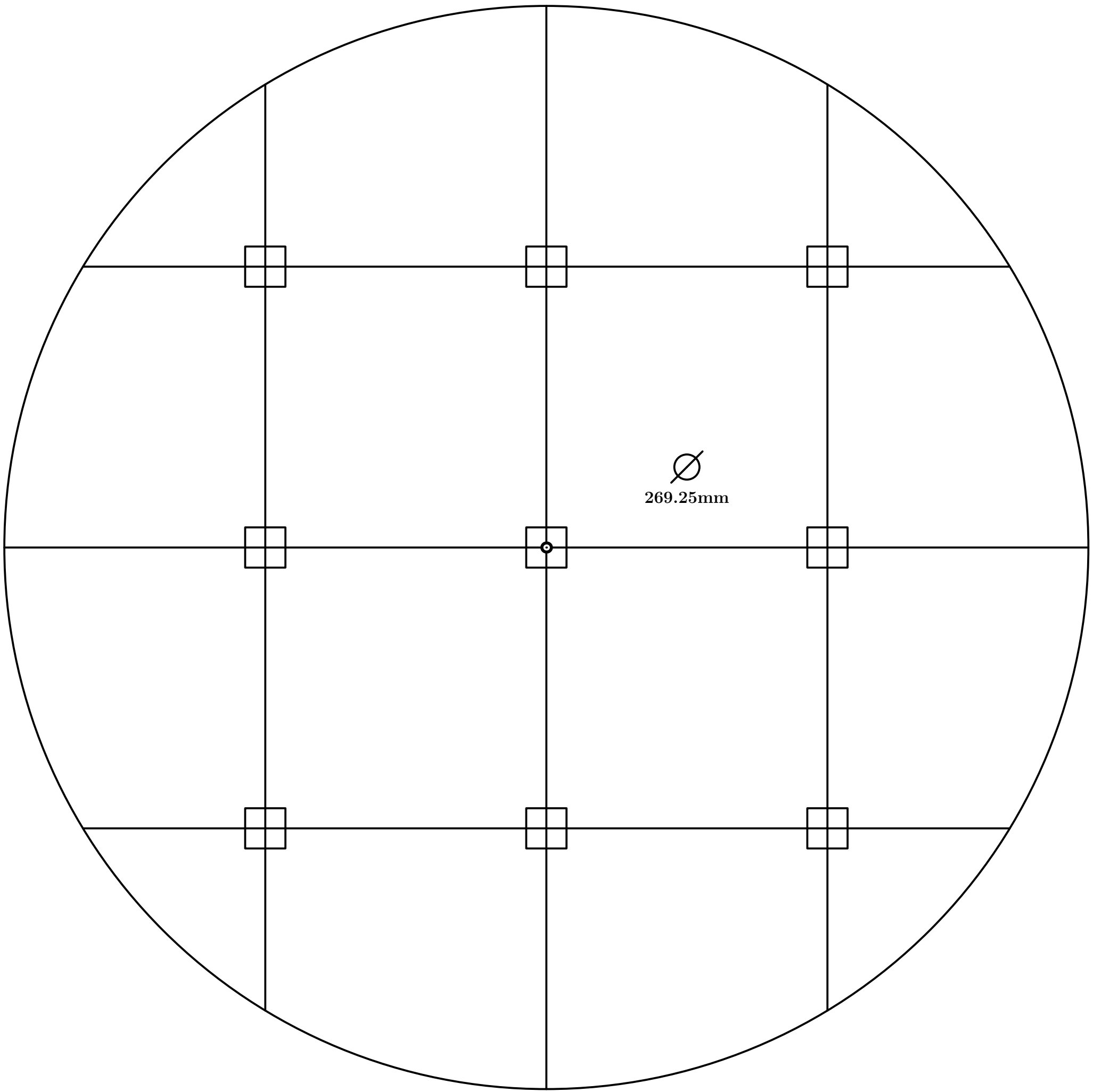

Fig. 678

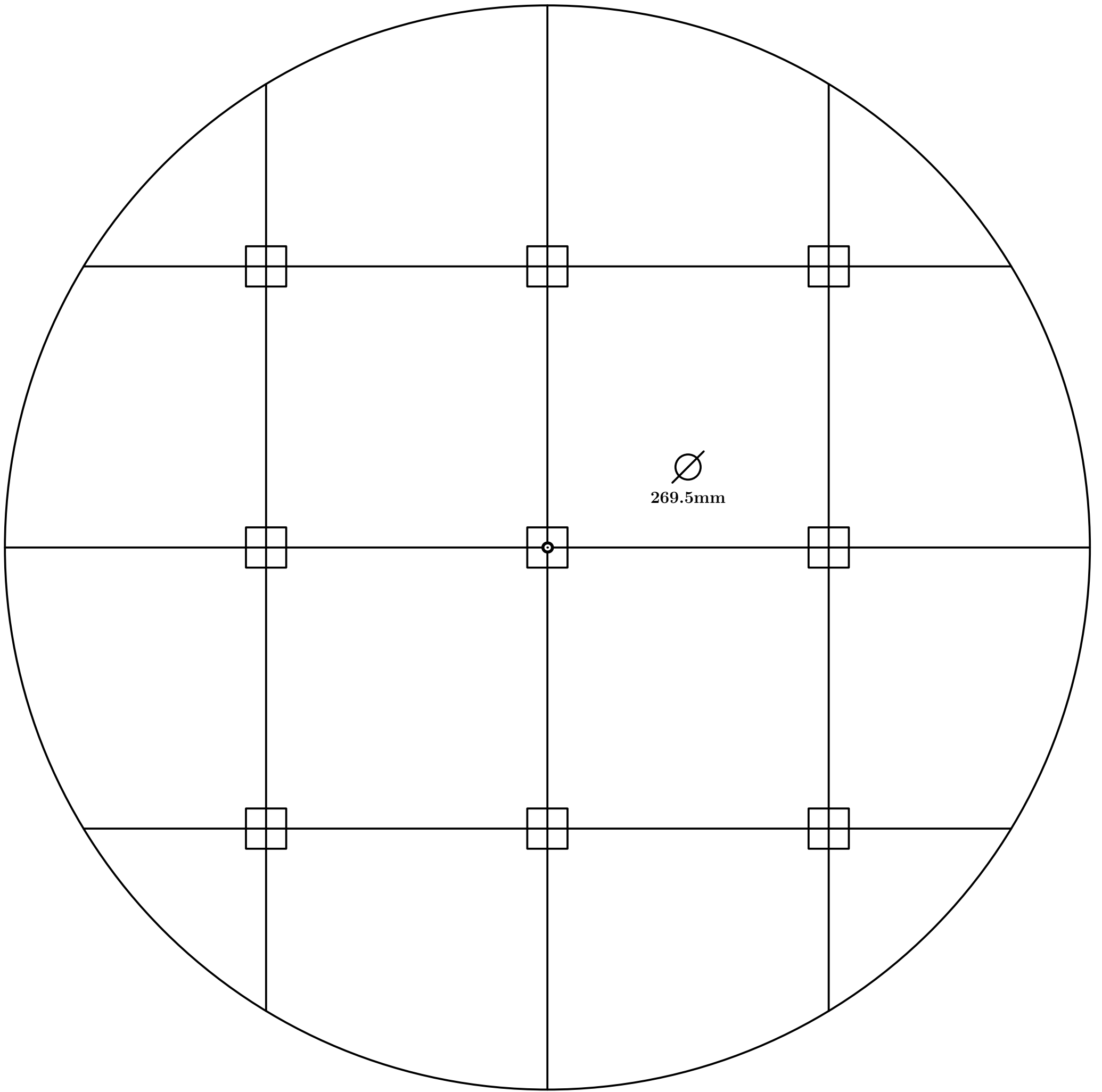

Fig. 679

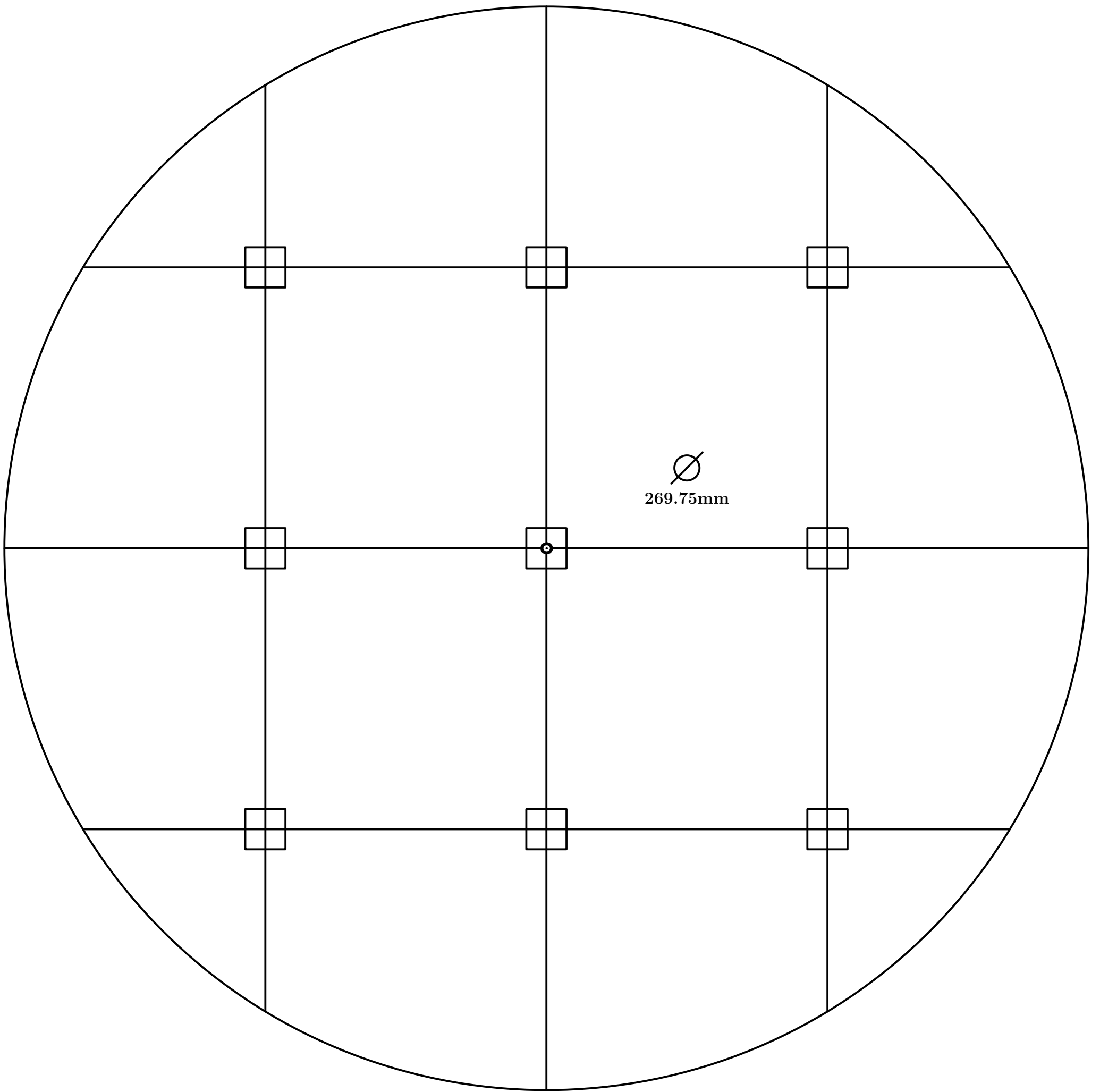

Fig. 680

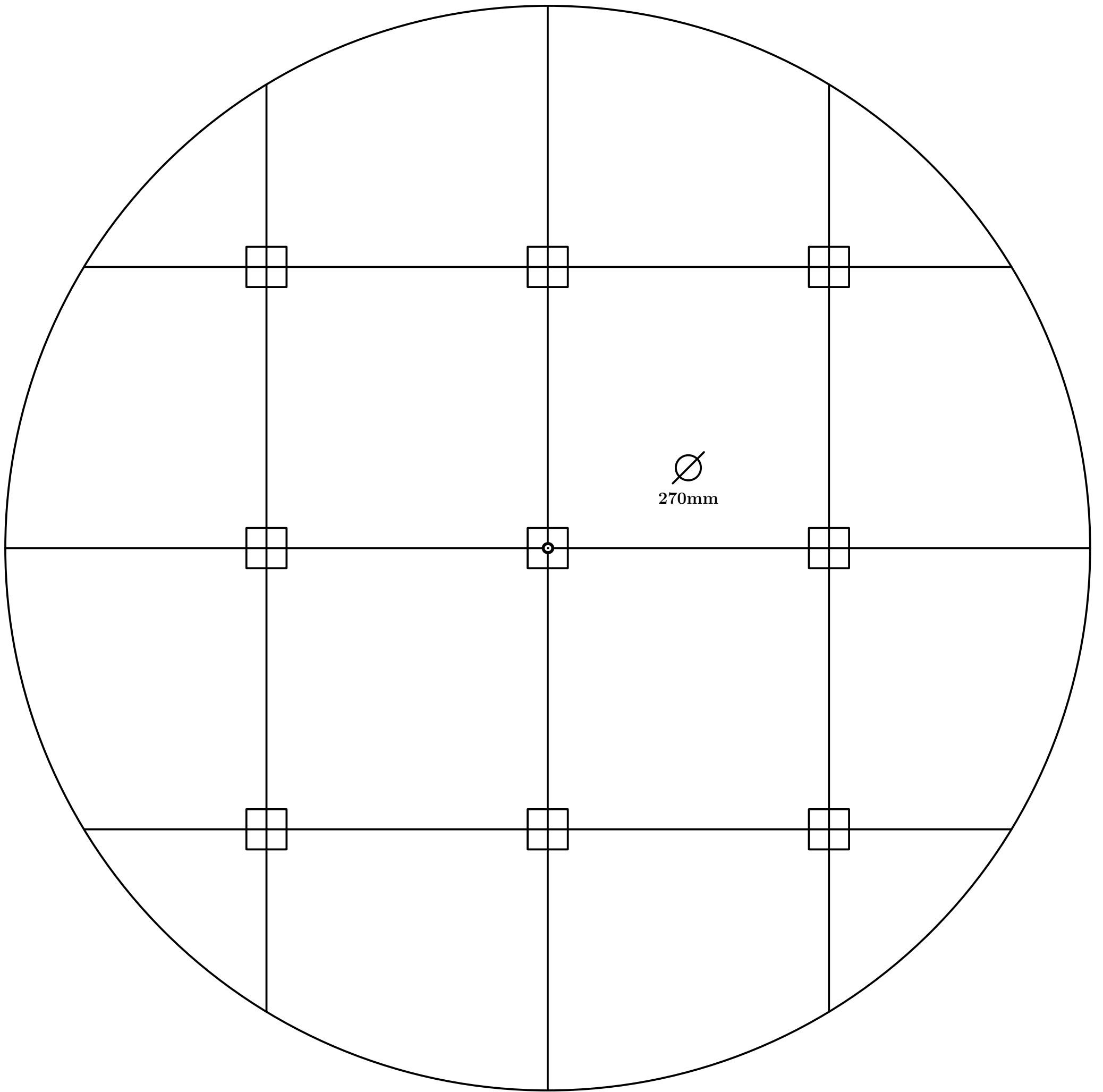

Fig. 681

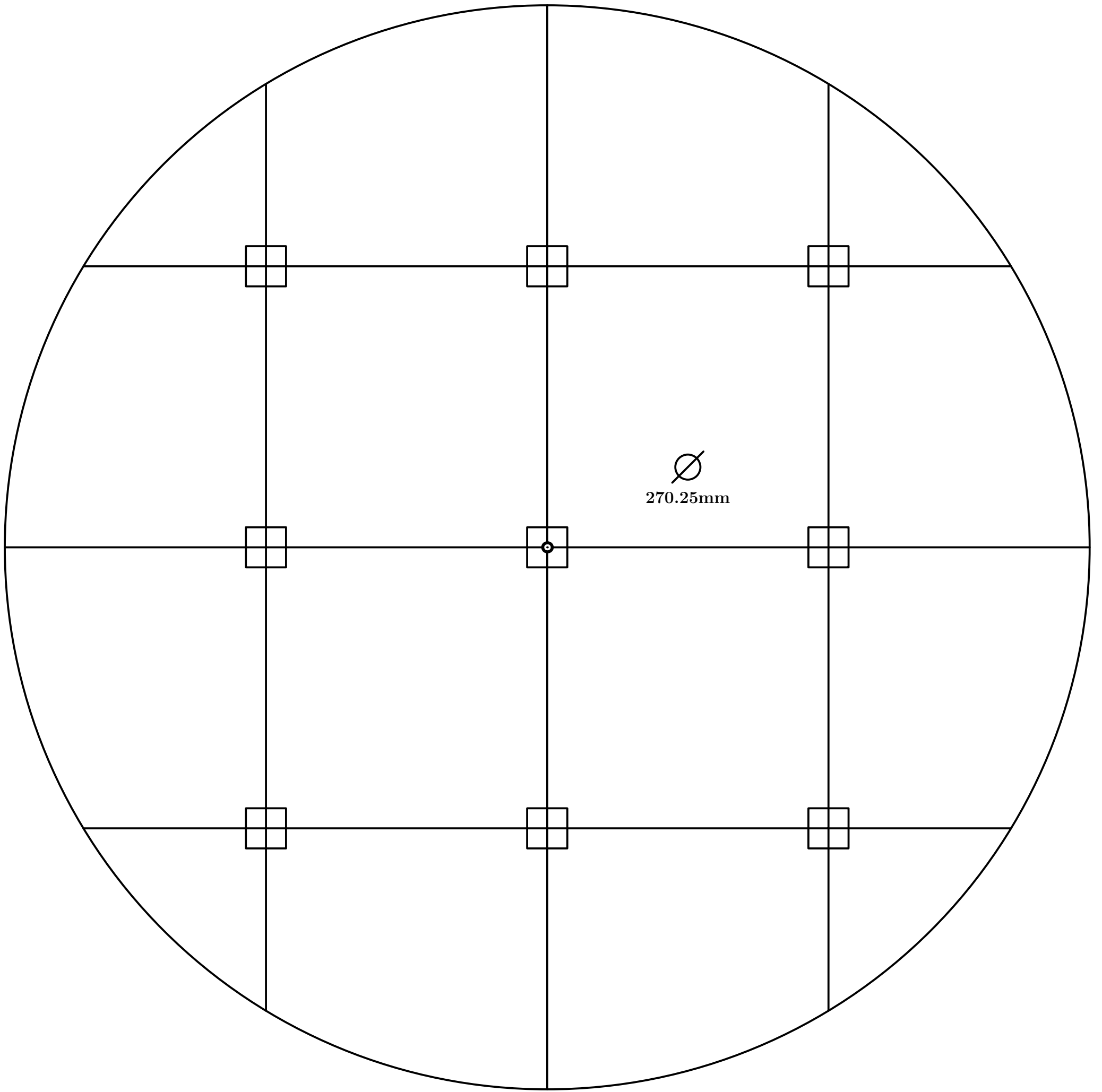

Fig. 682

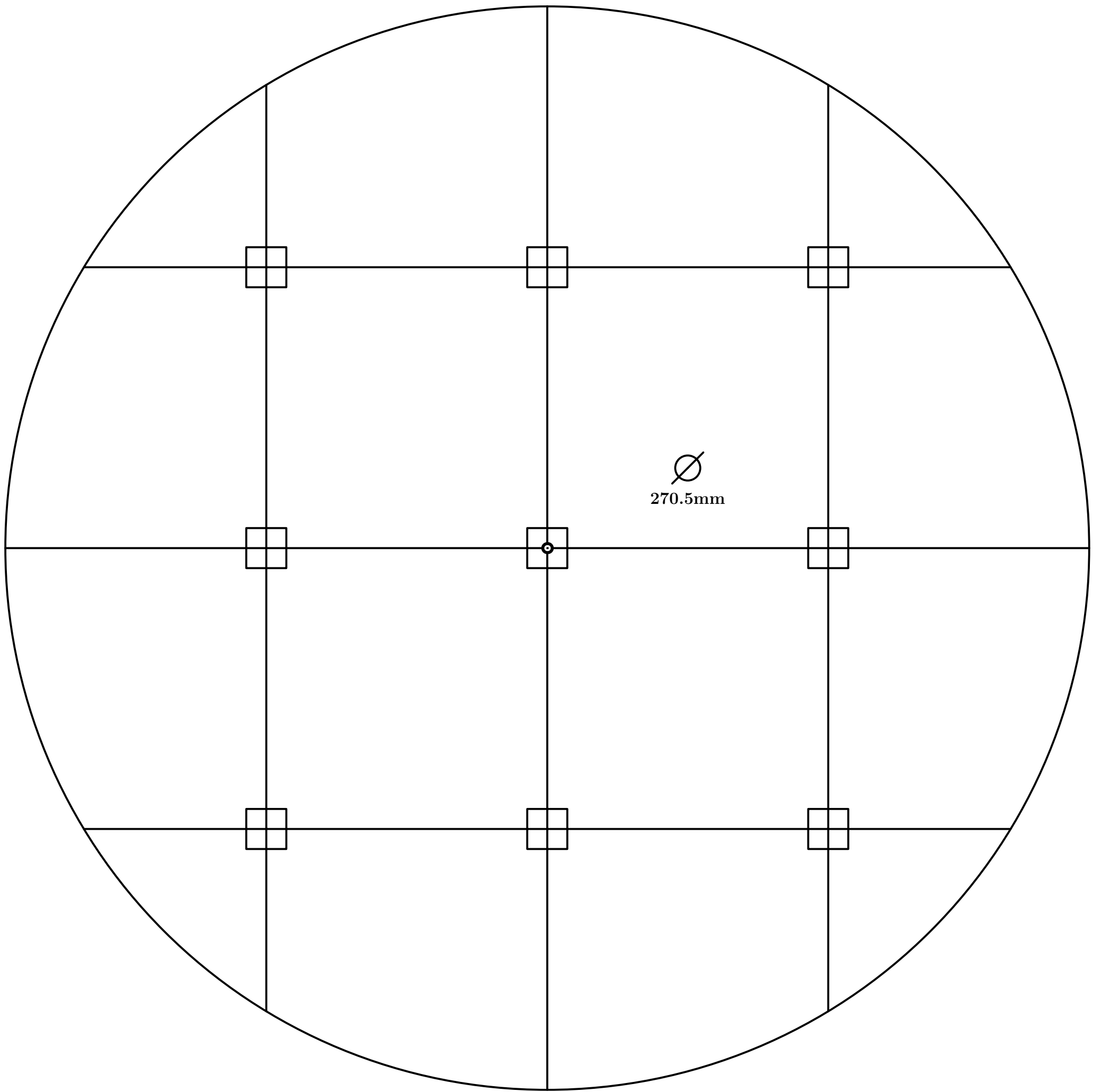

Fig. 683

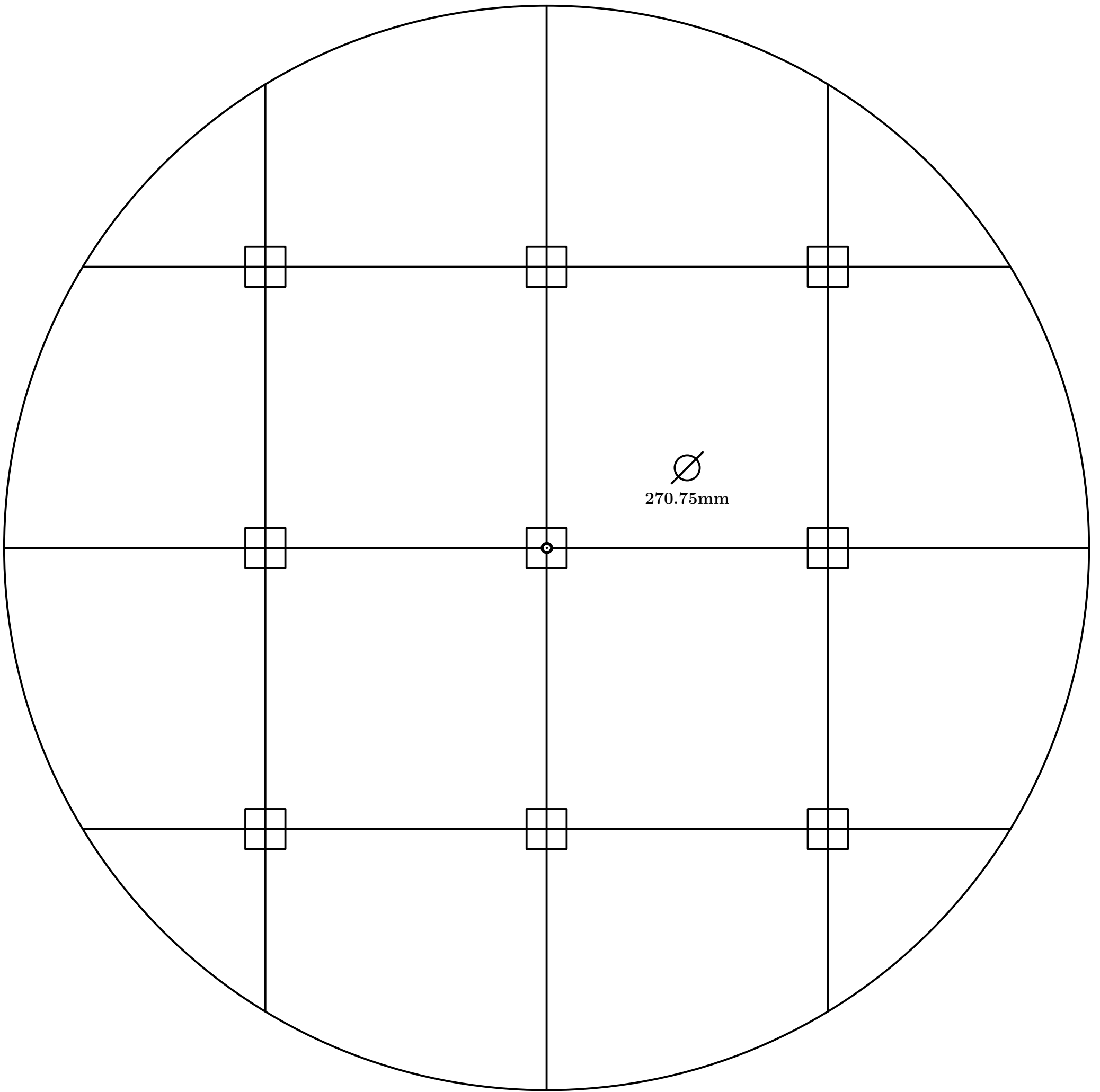

Fig. 684

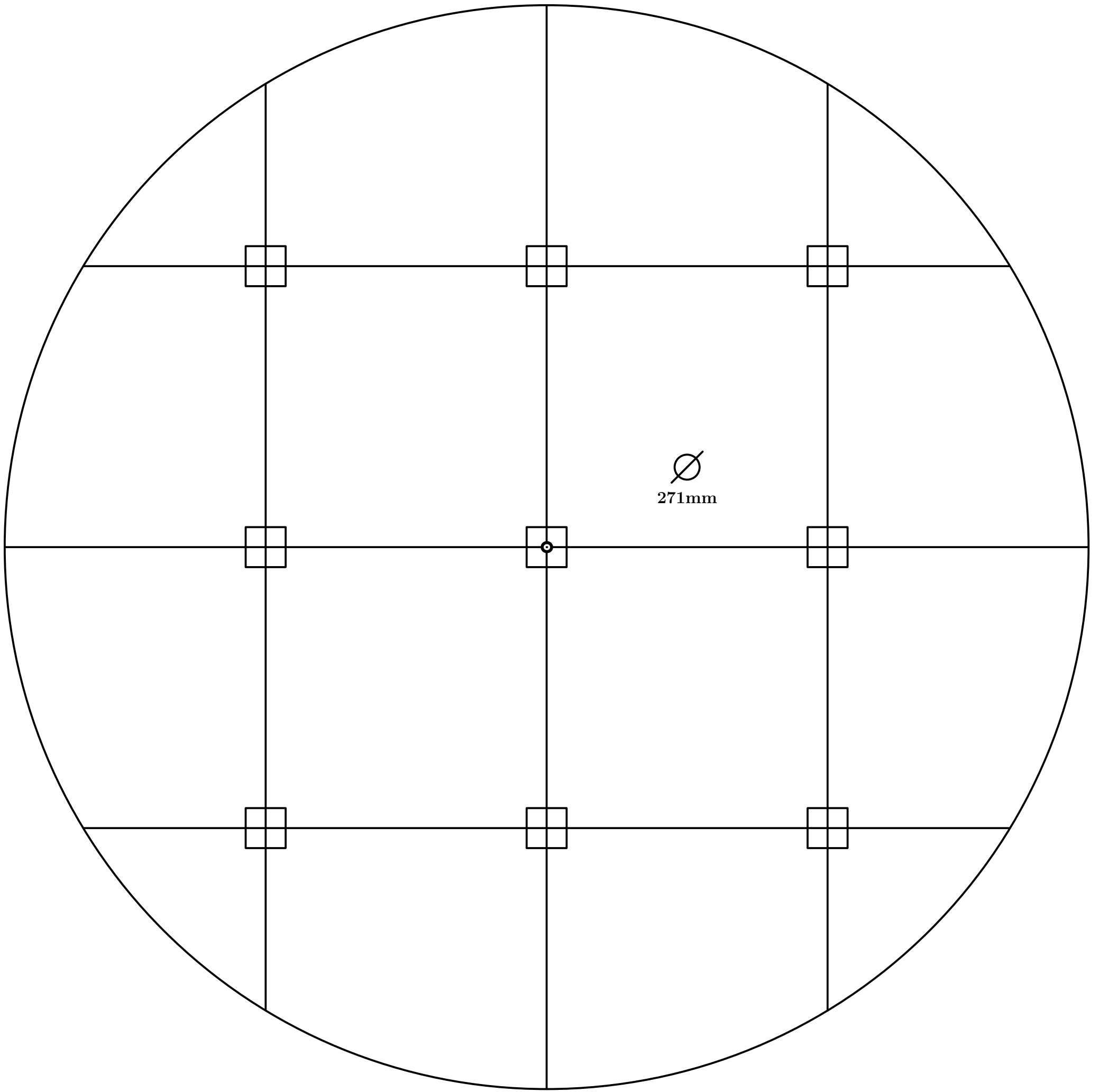

Fig. 685

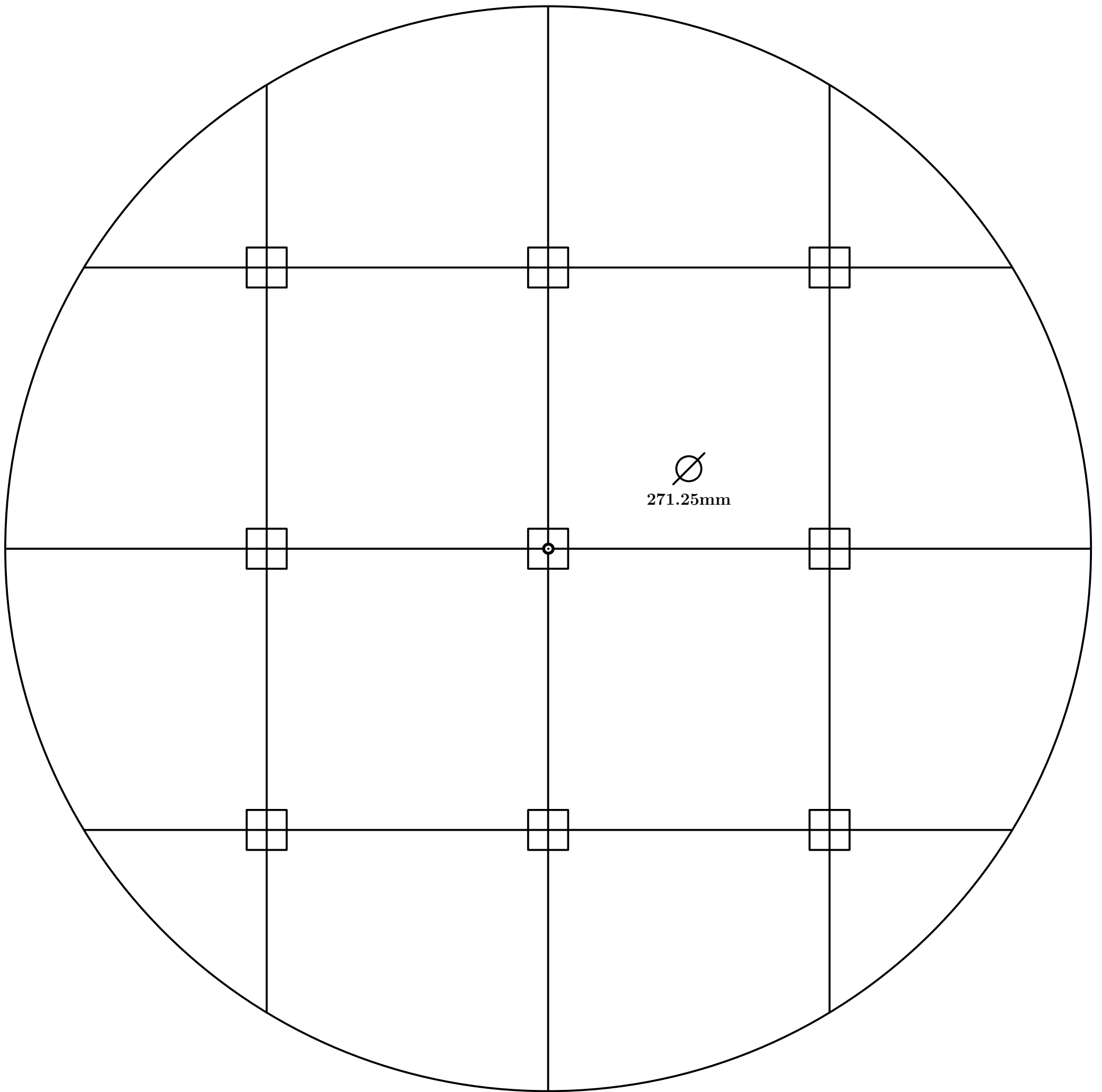

Fig. 686

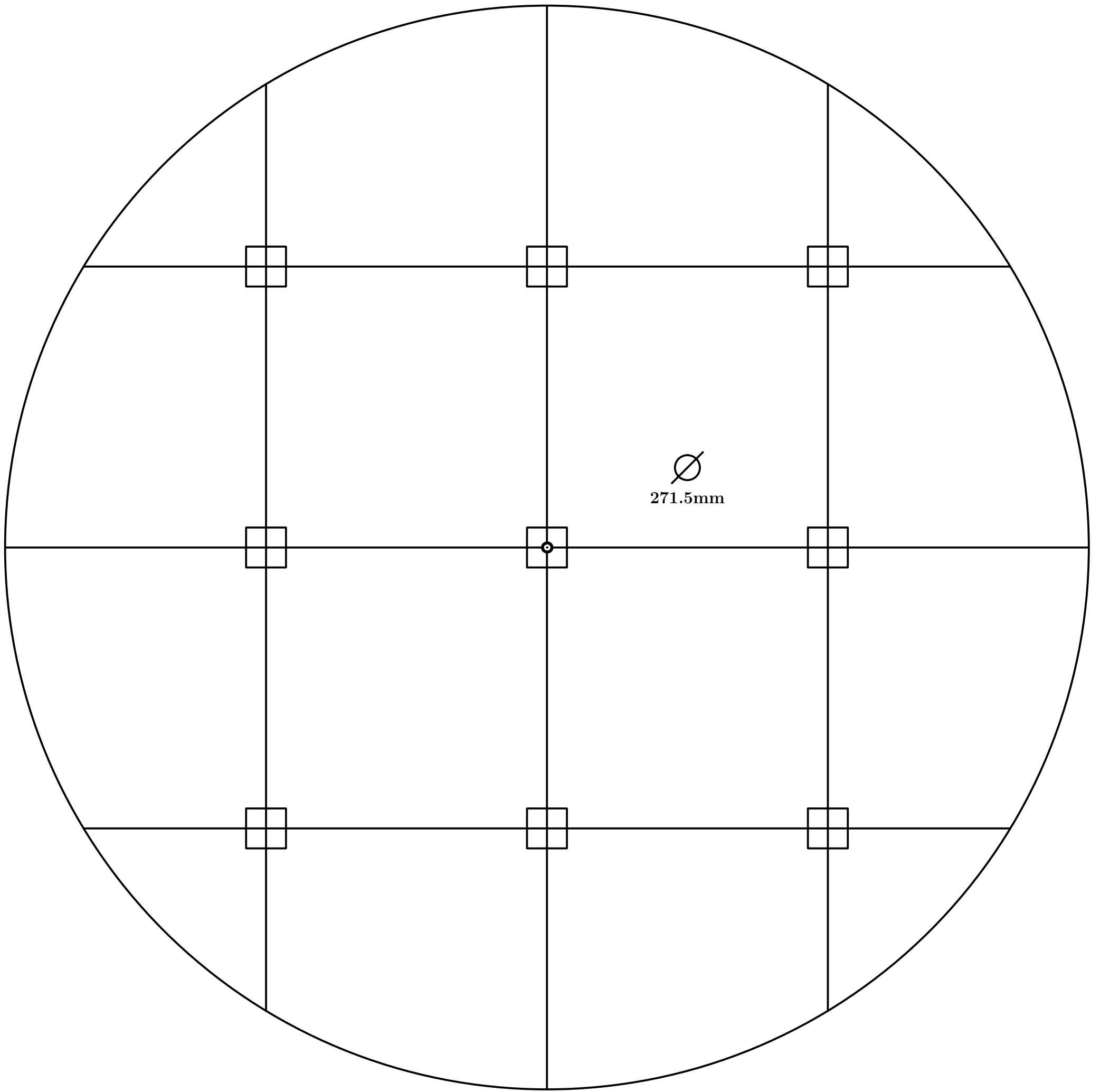

Fig. 687

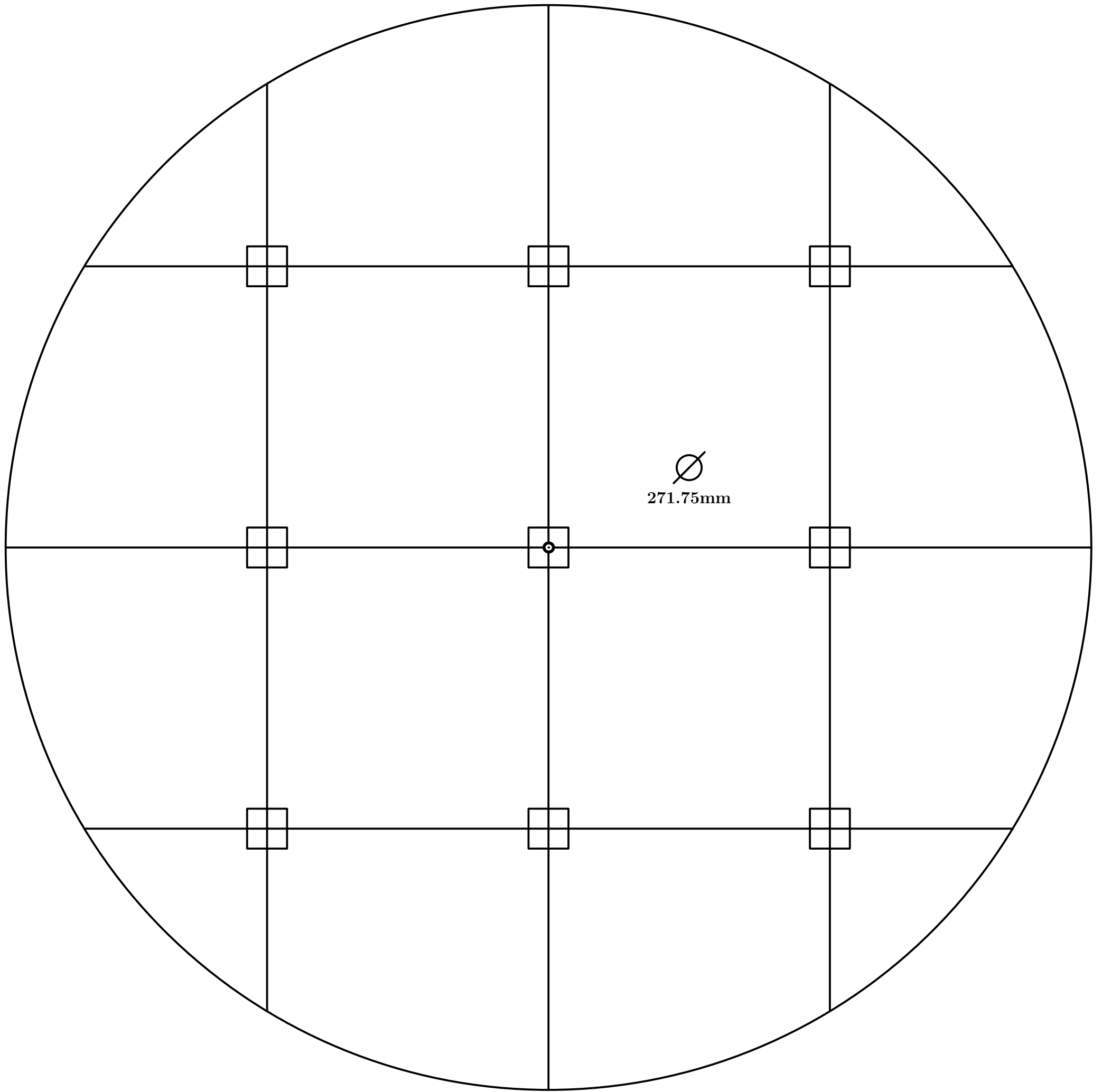

Fig. 688

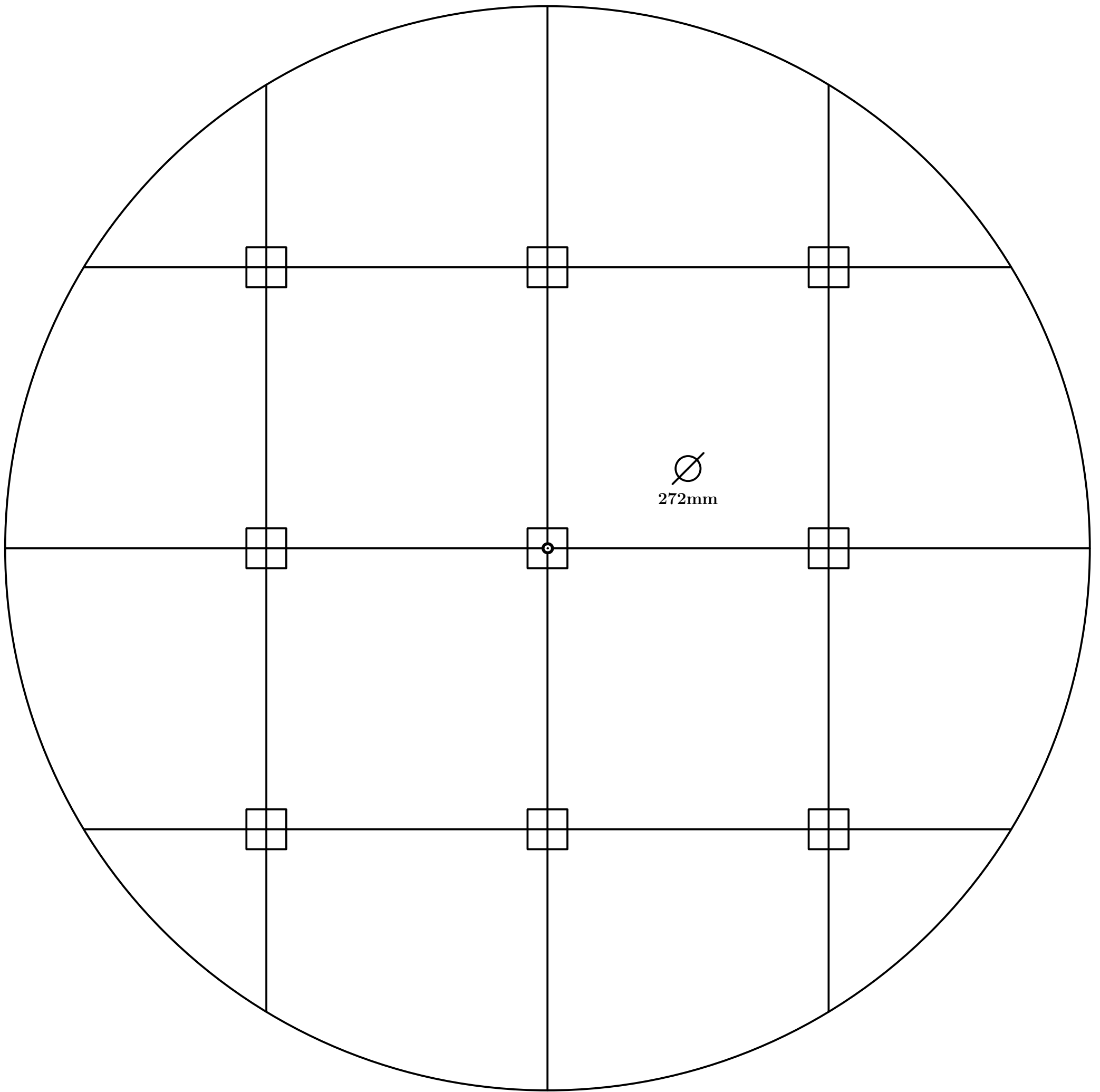

Fig. 689

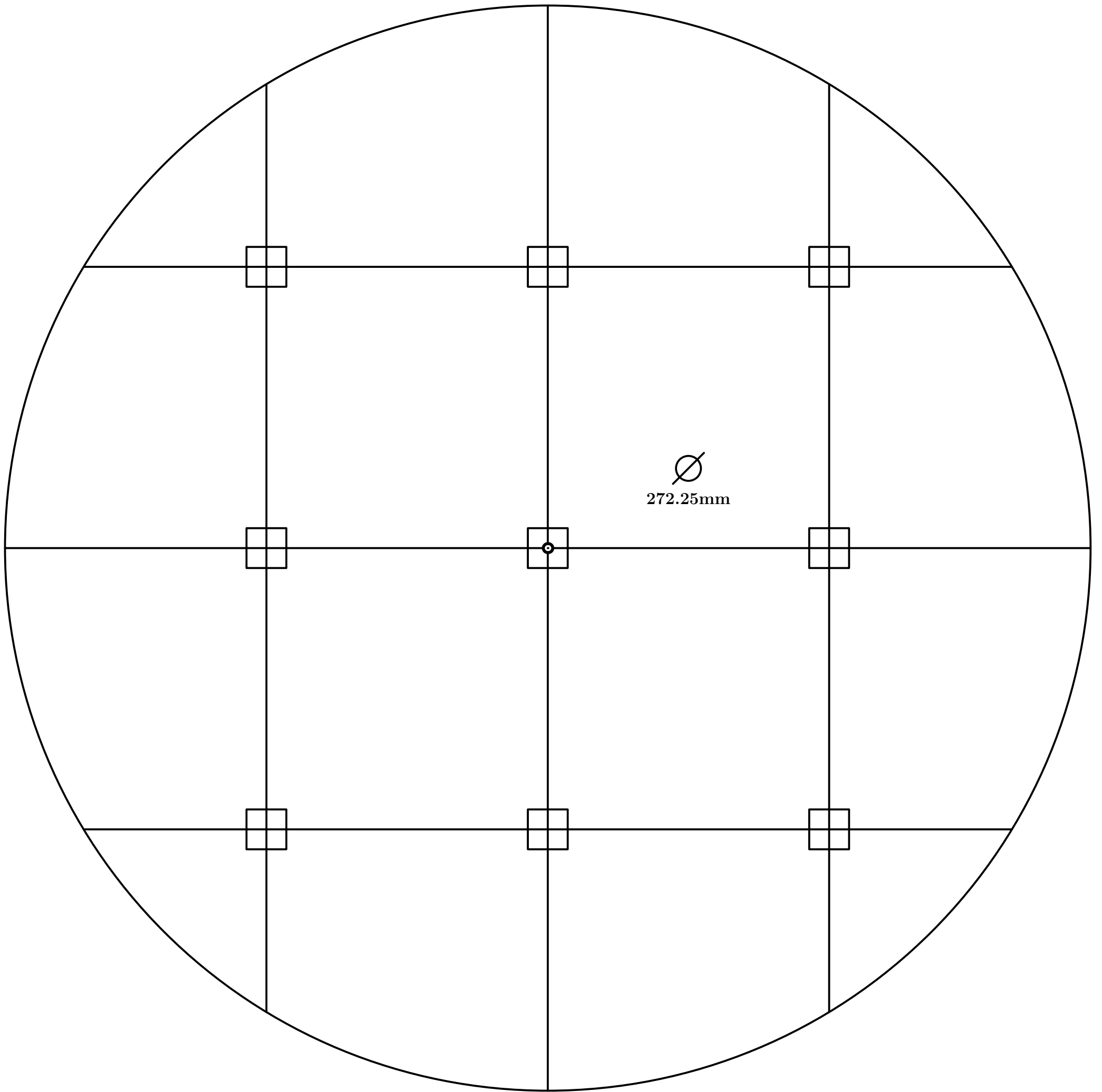

Fig. 690

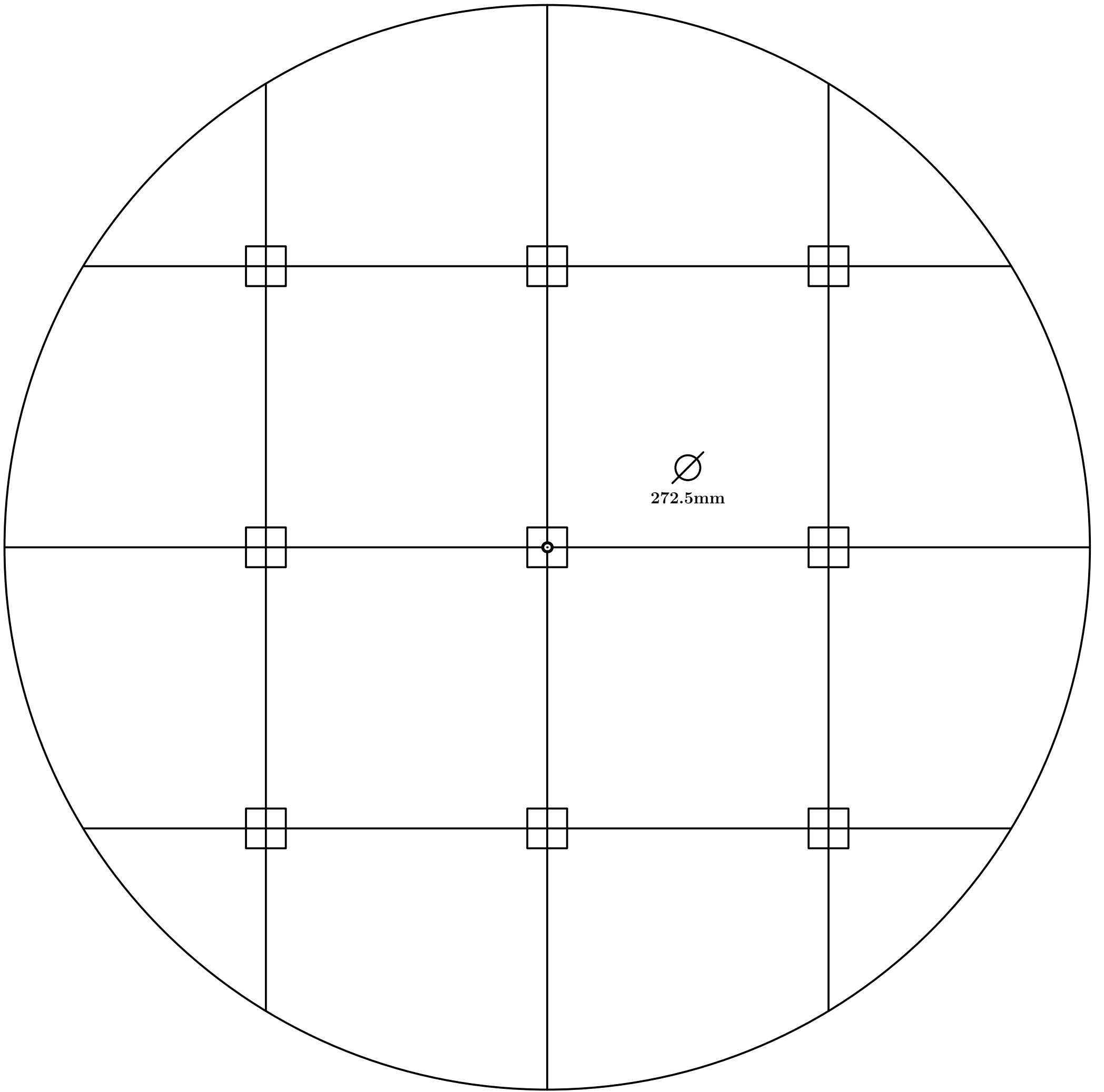

Fig. 691

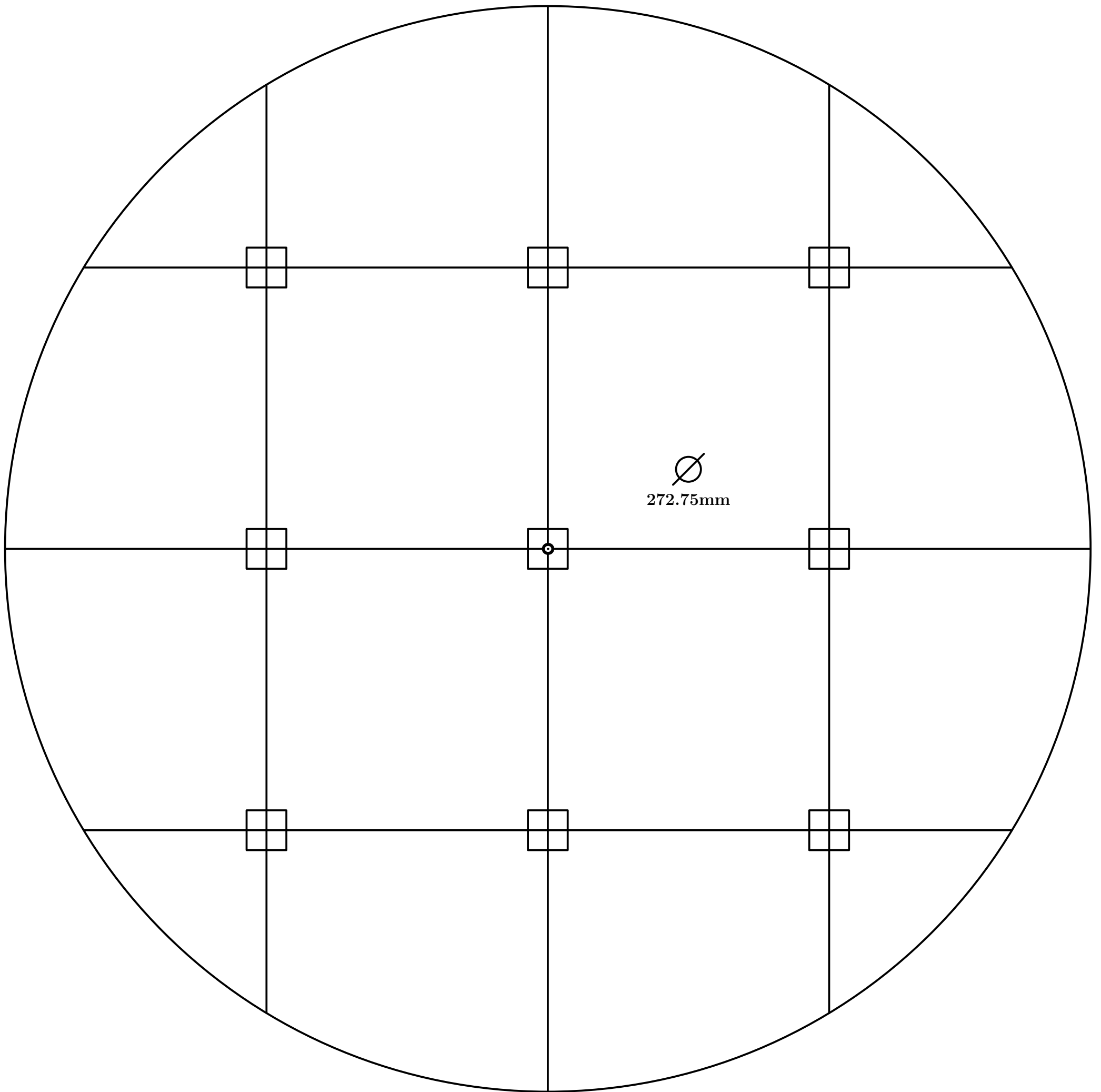

Fig. 692

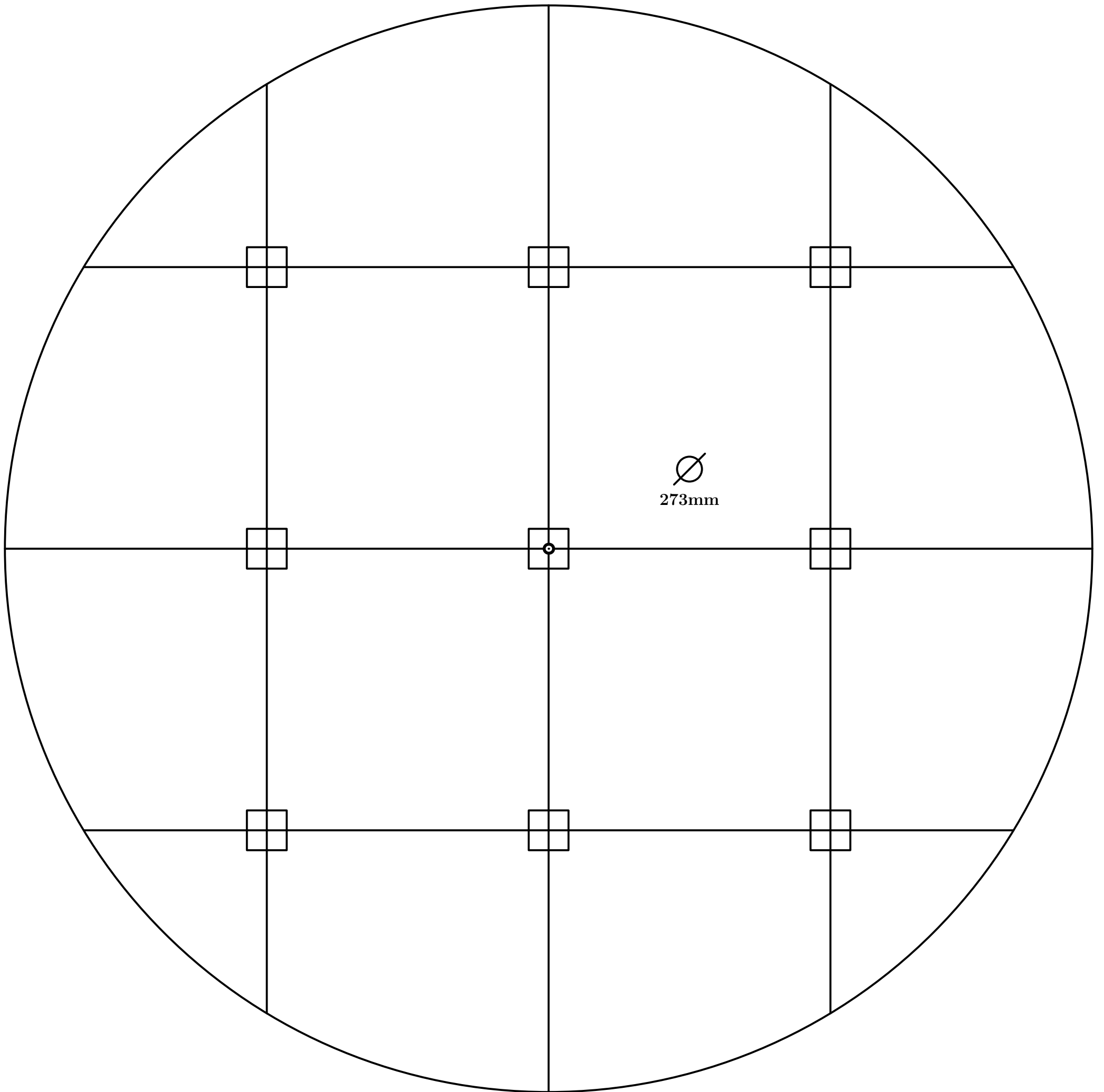

Fig. 693

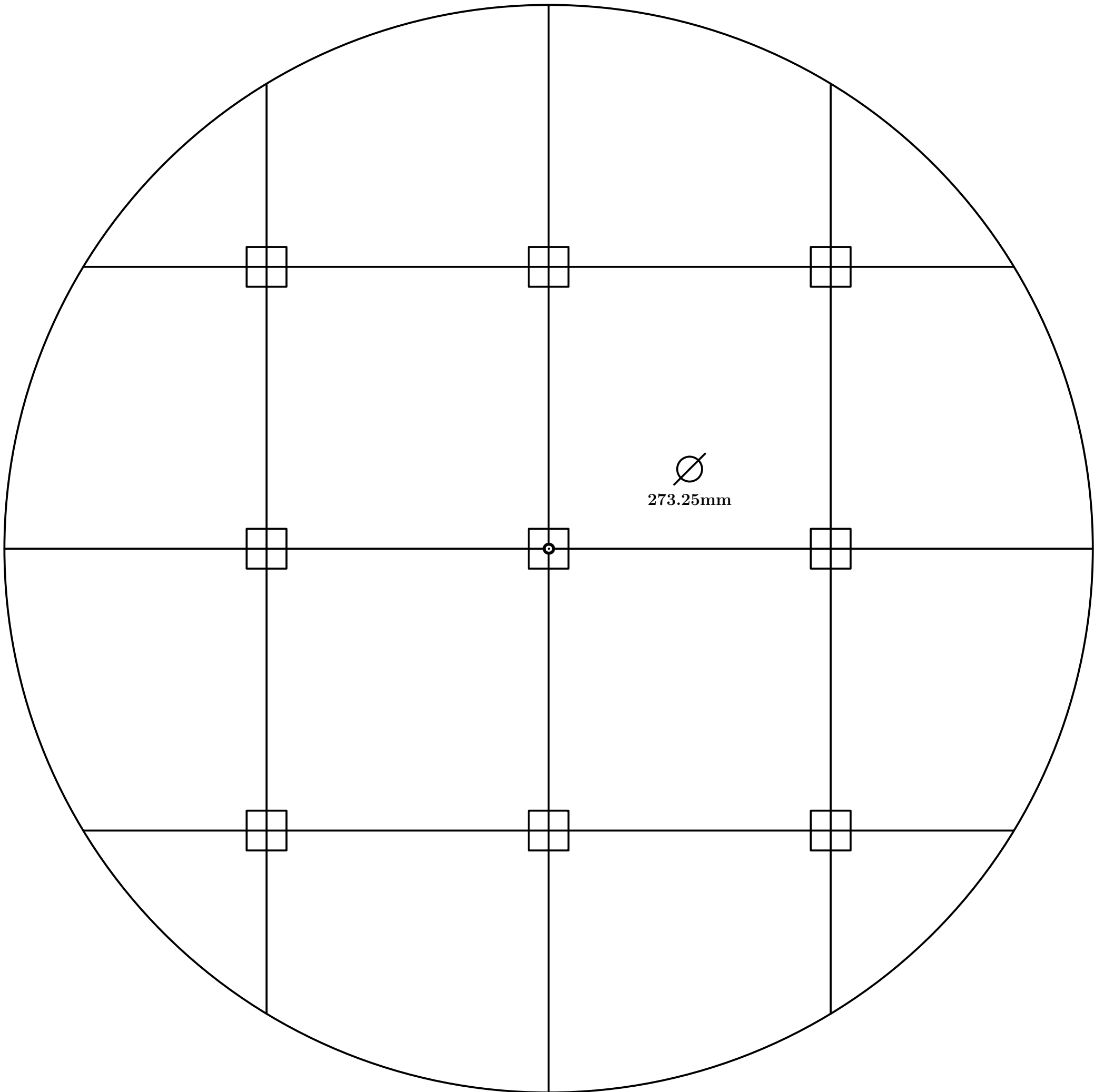

Fig. 694

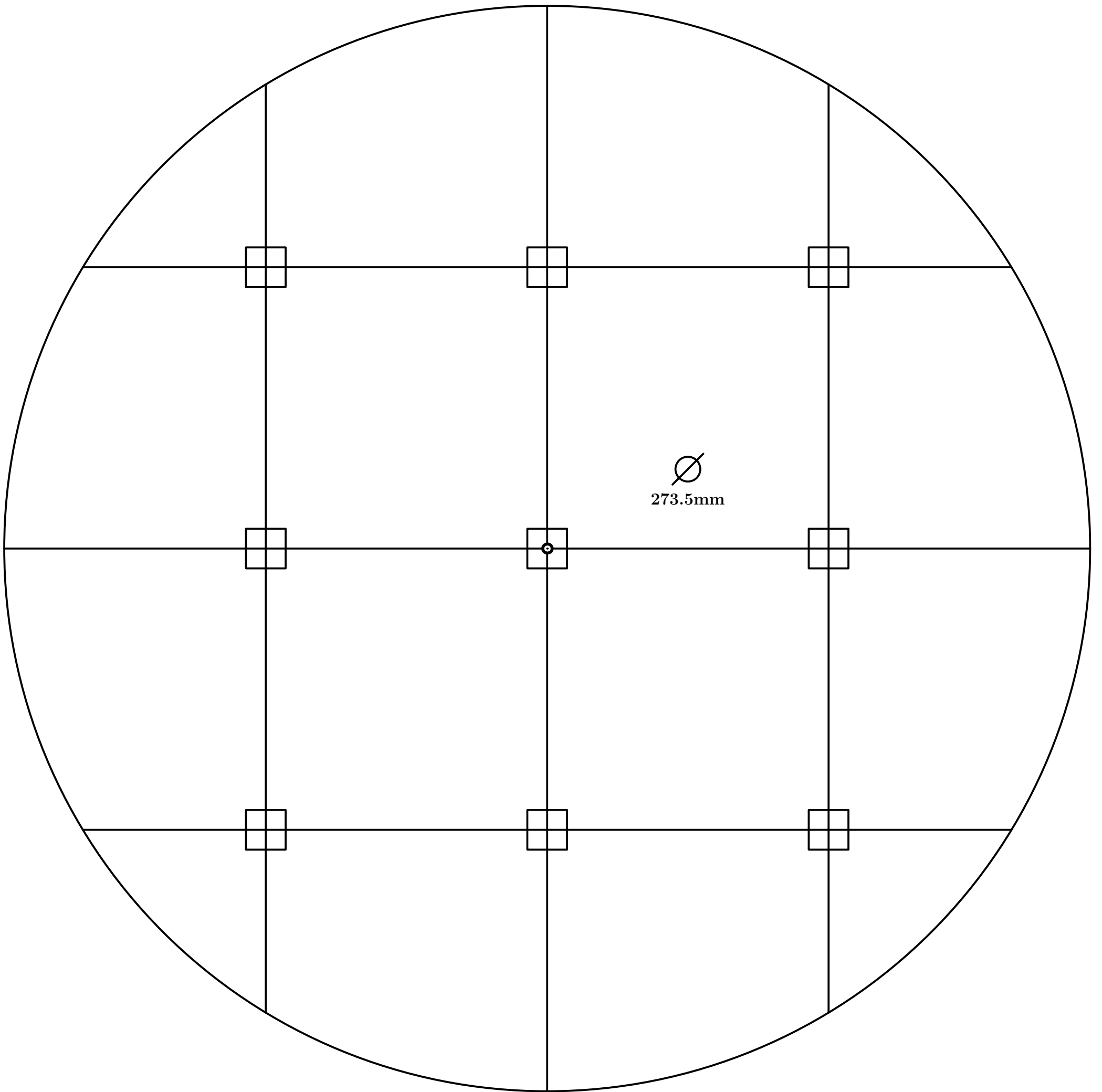

Fig. 695

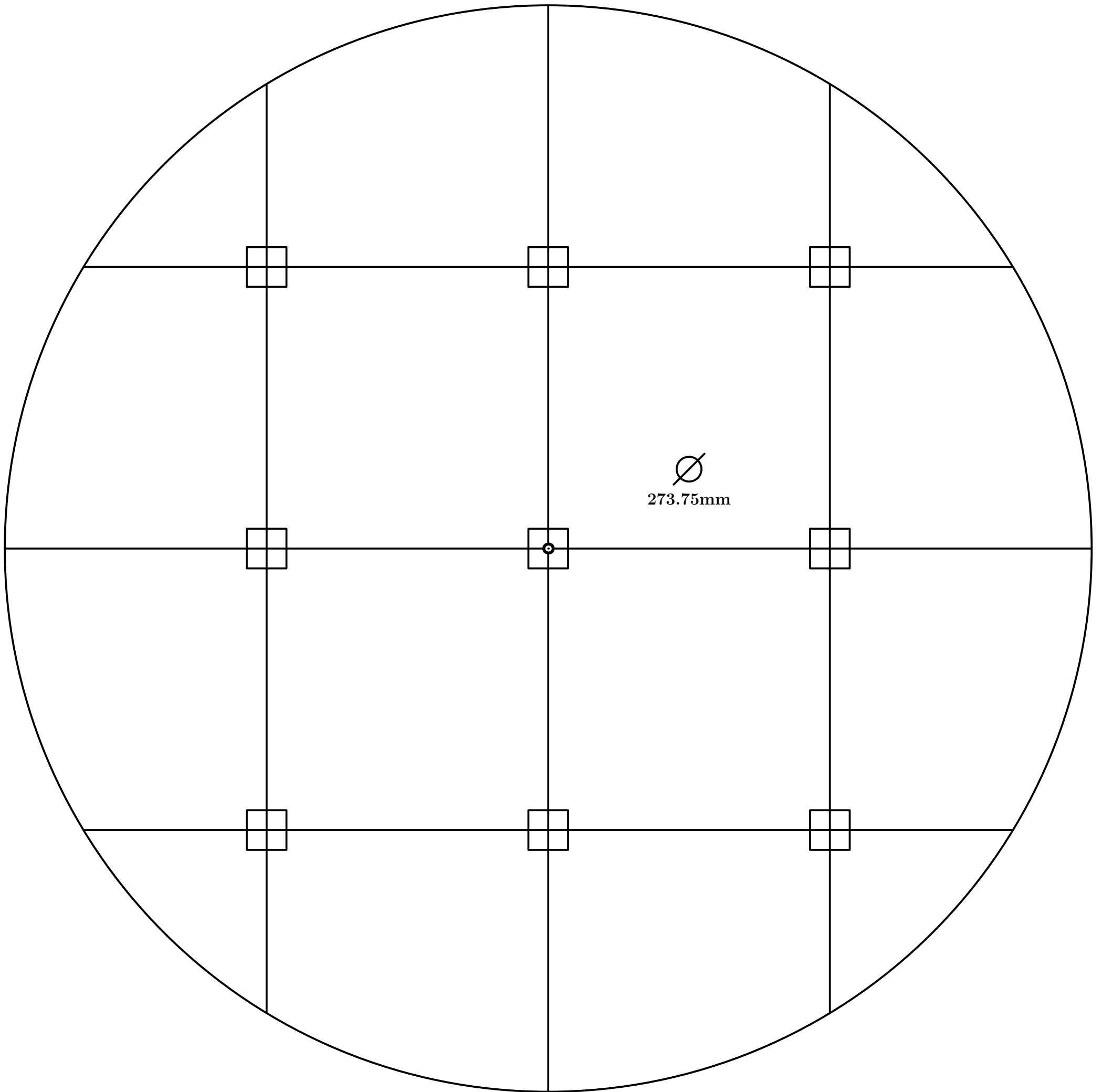

Fig. 696

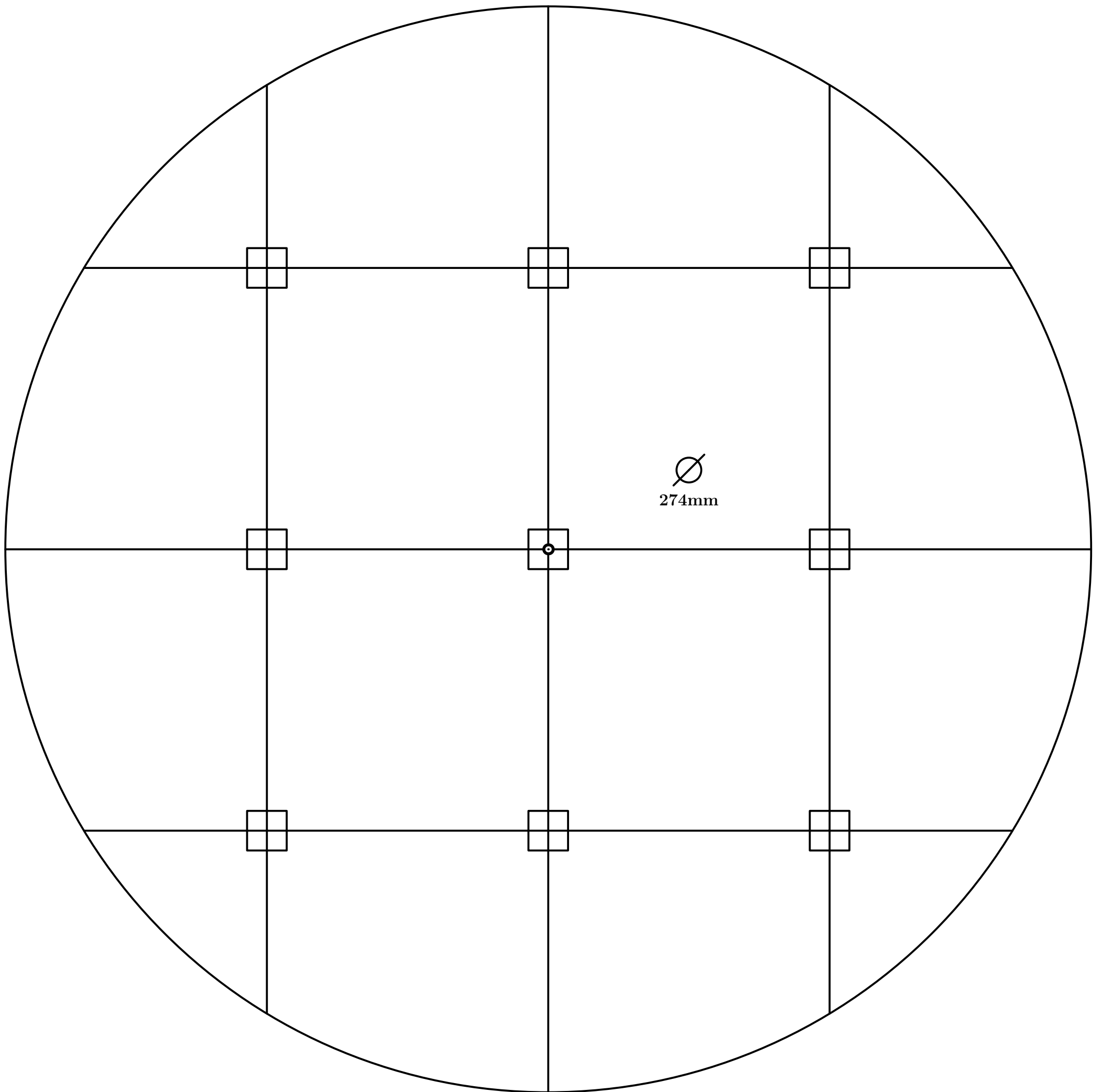

Fig. 697

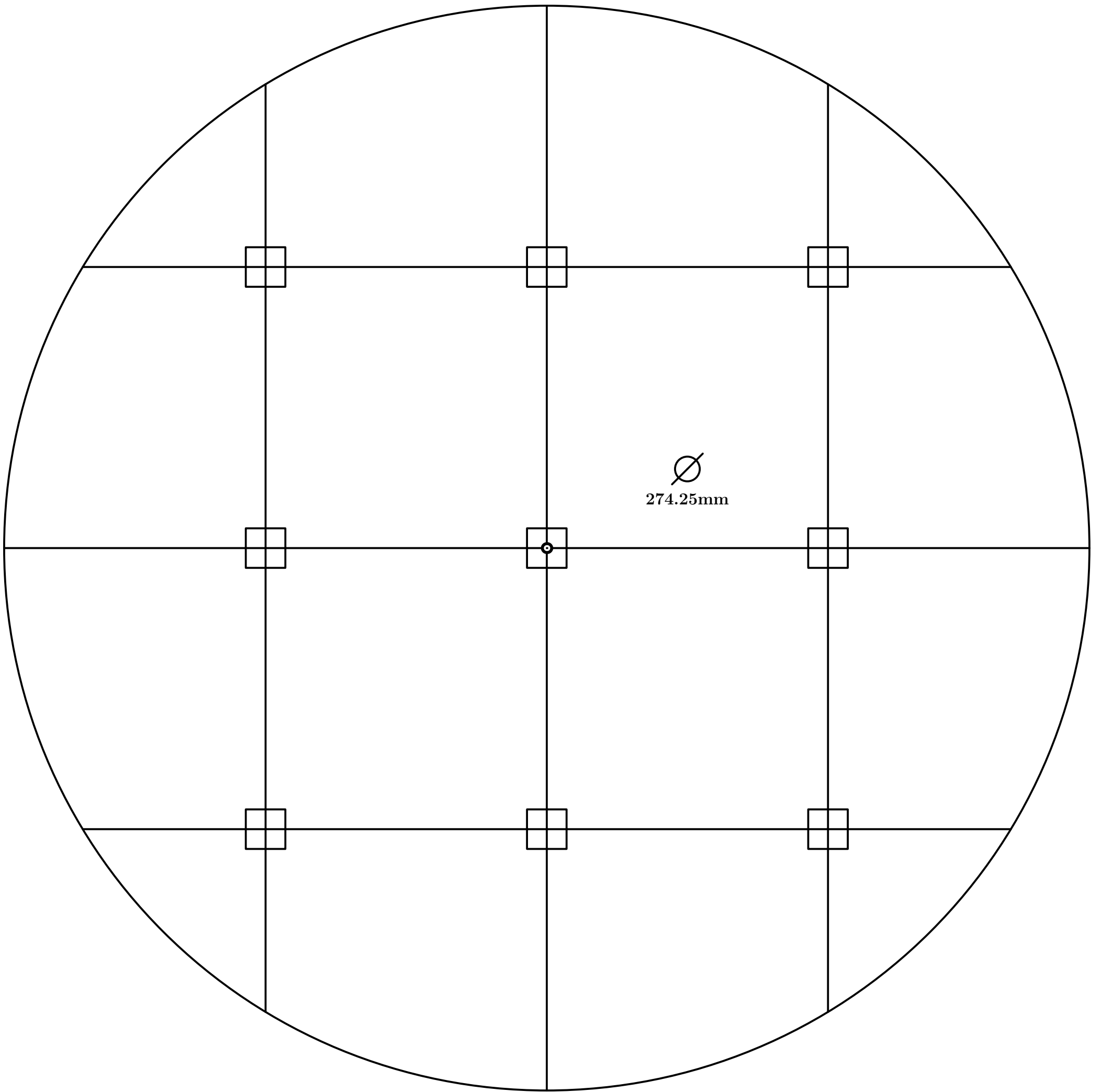

Fig. 698

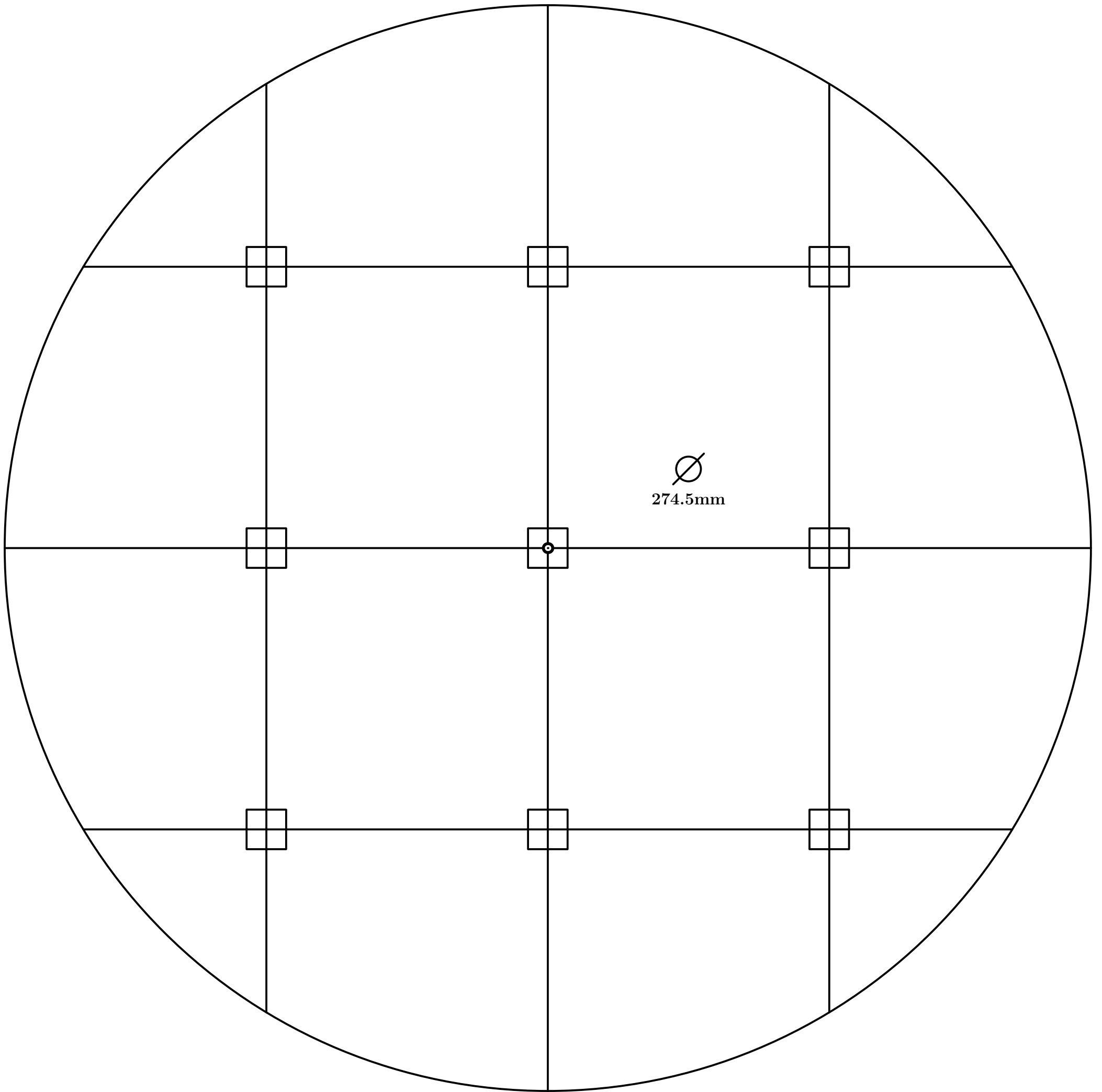

Fig. 699

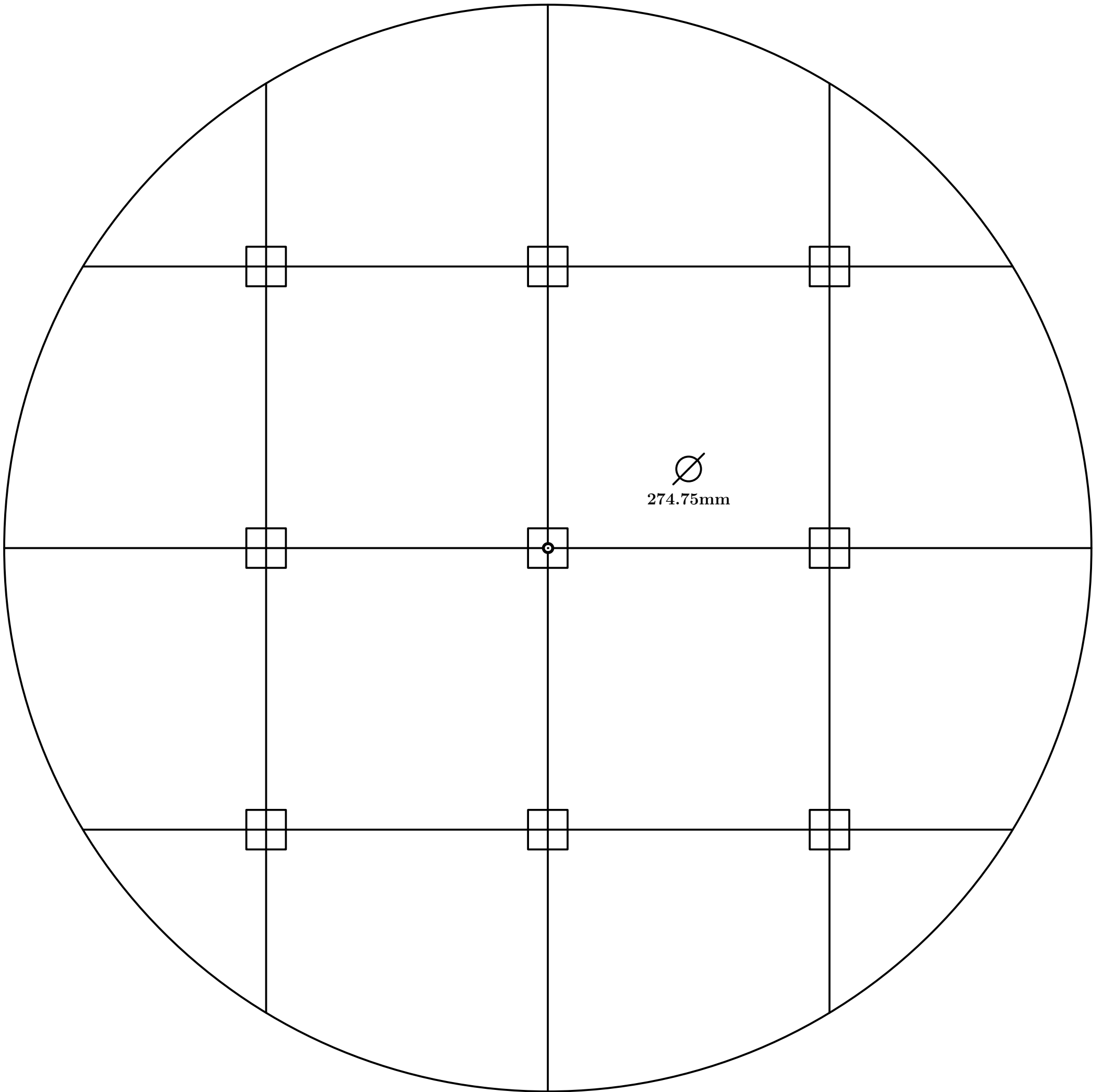

Fig. 700

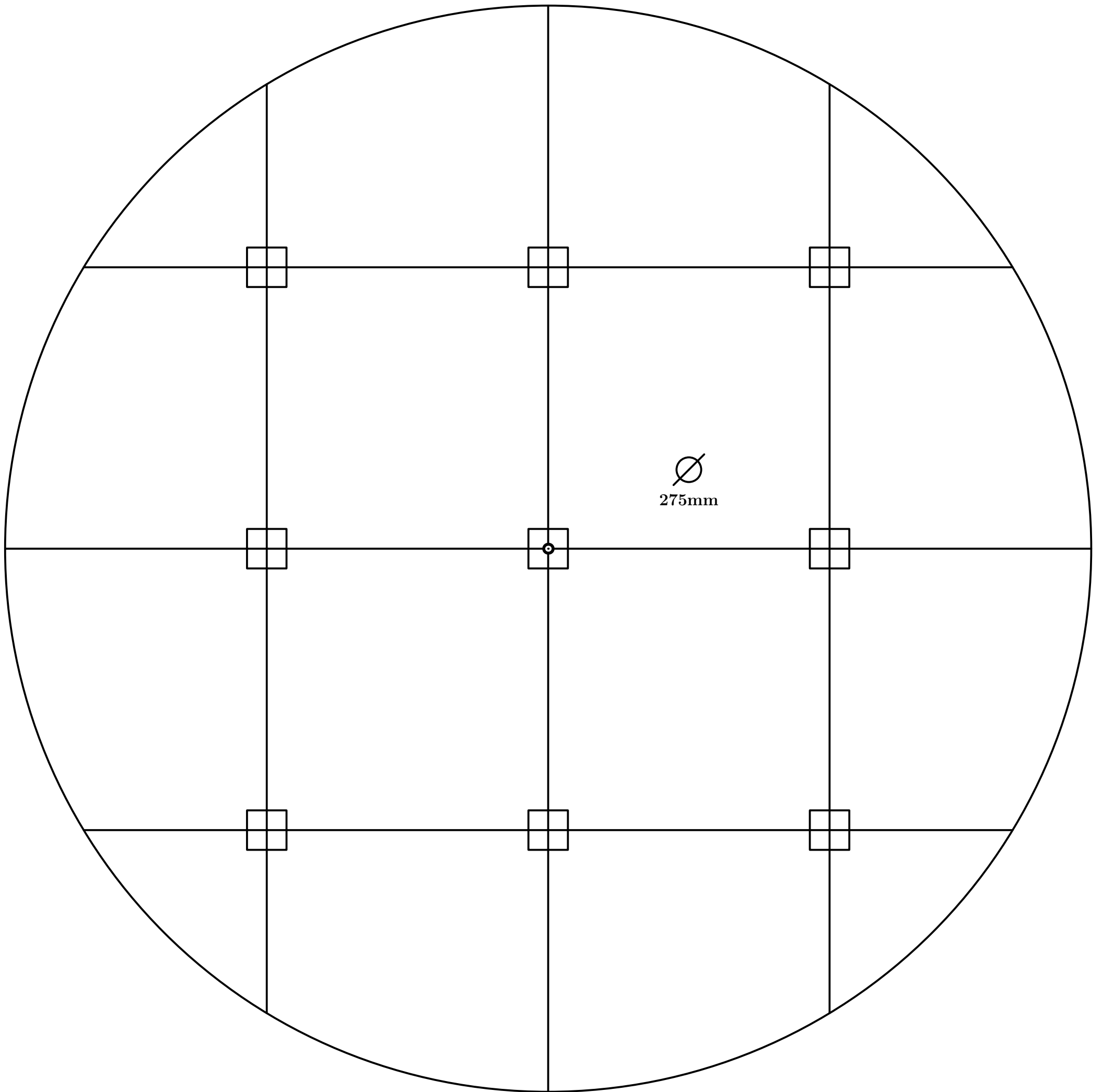

Fig. 701

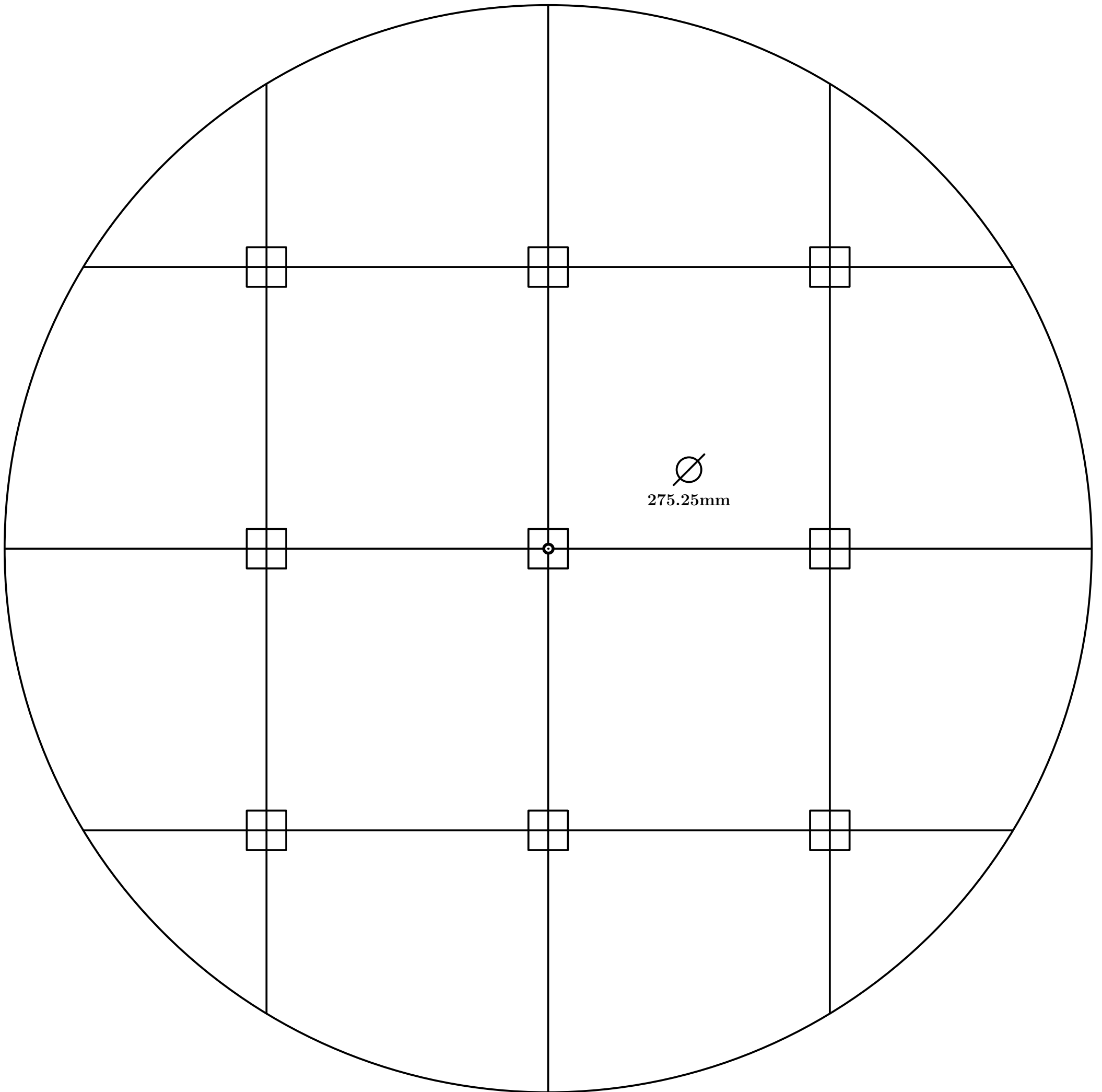

Fig. 702

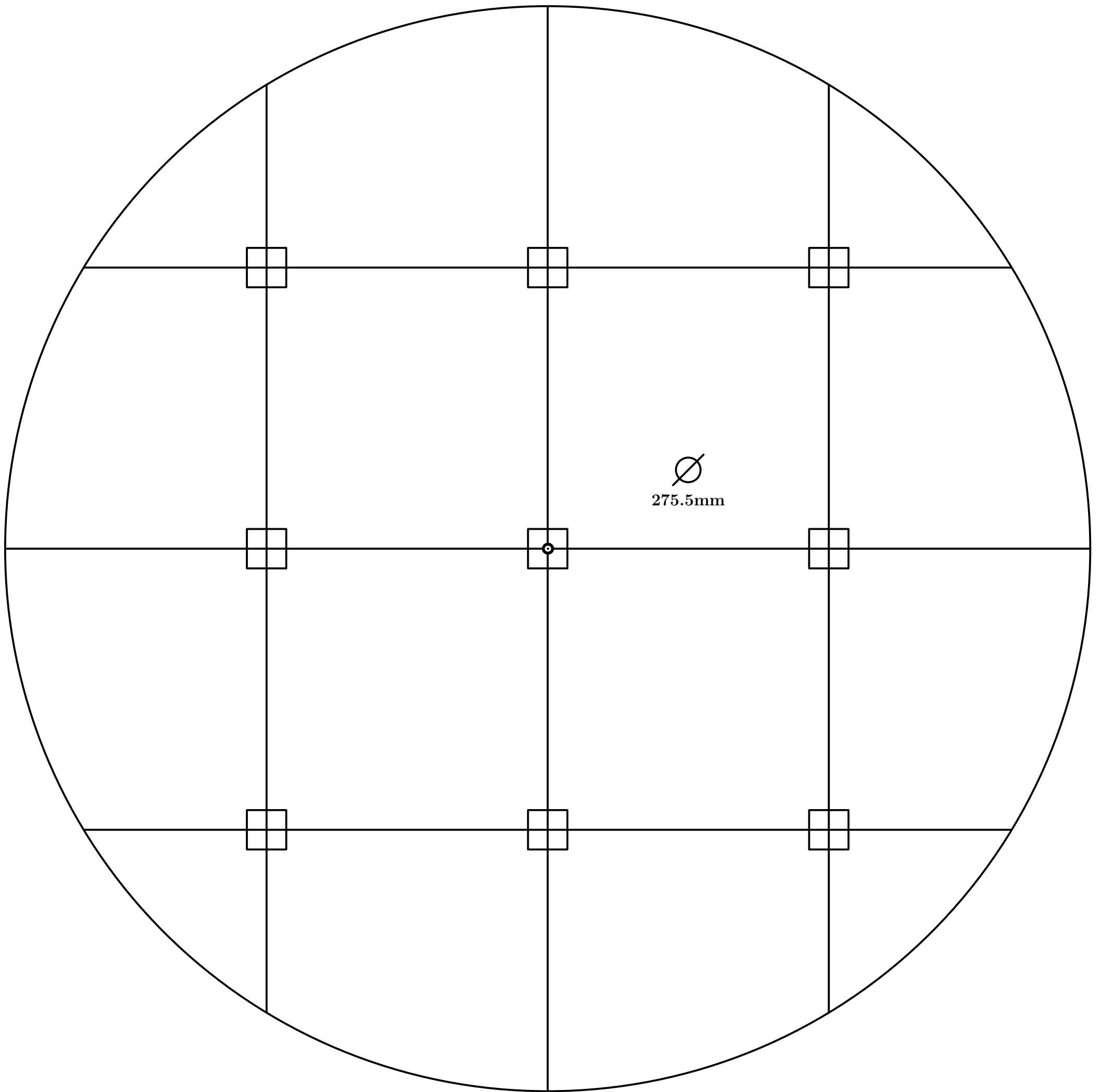

Fig. 703

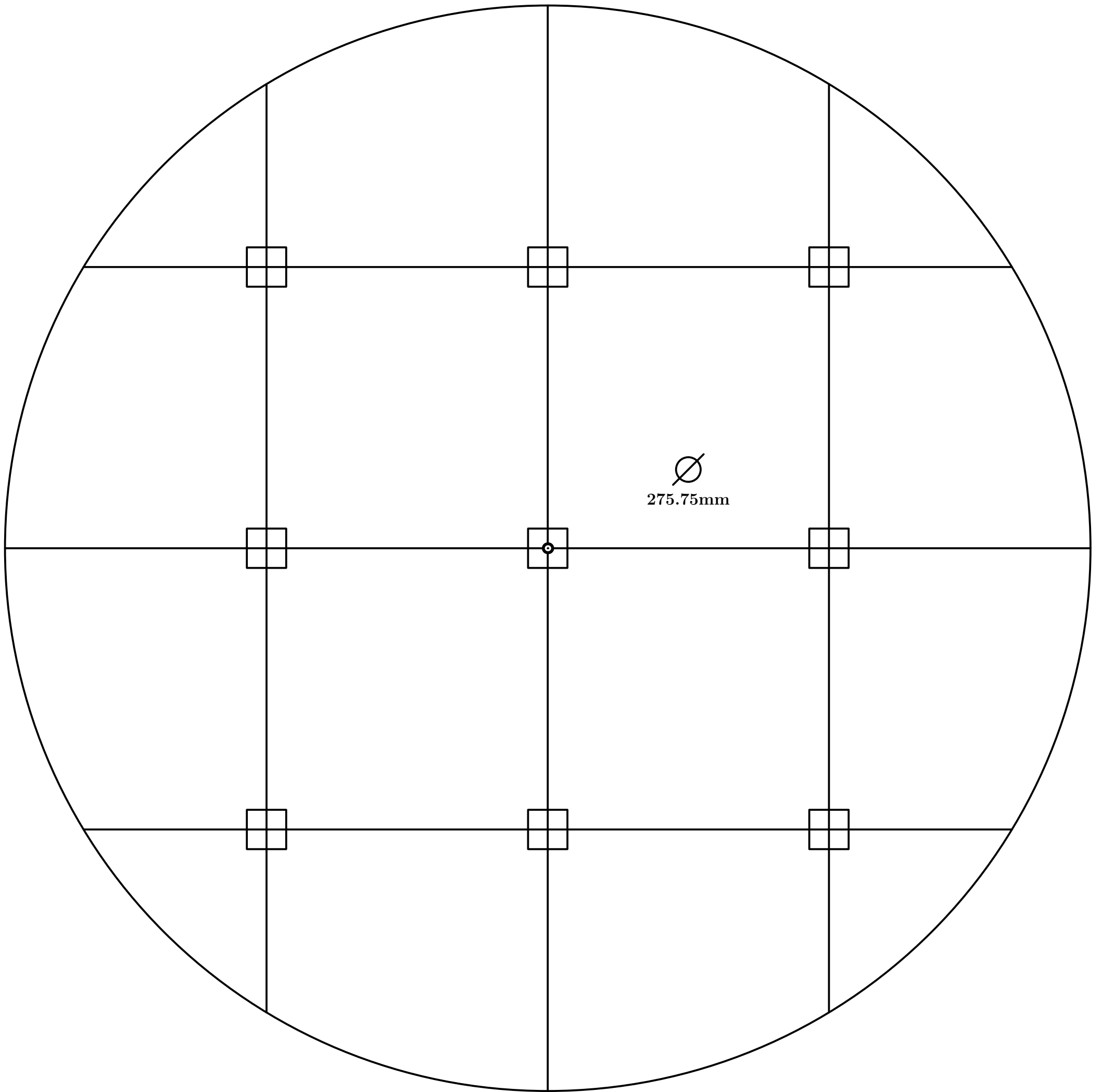

Fig. 704

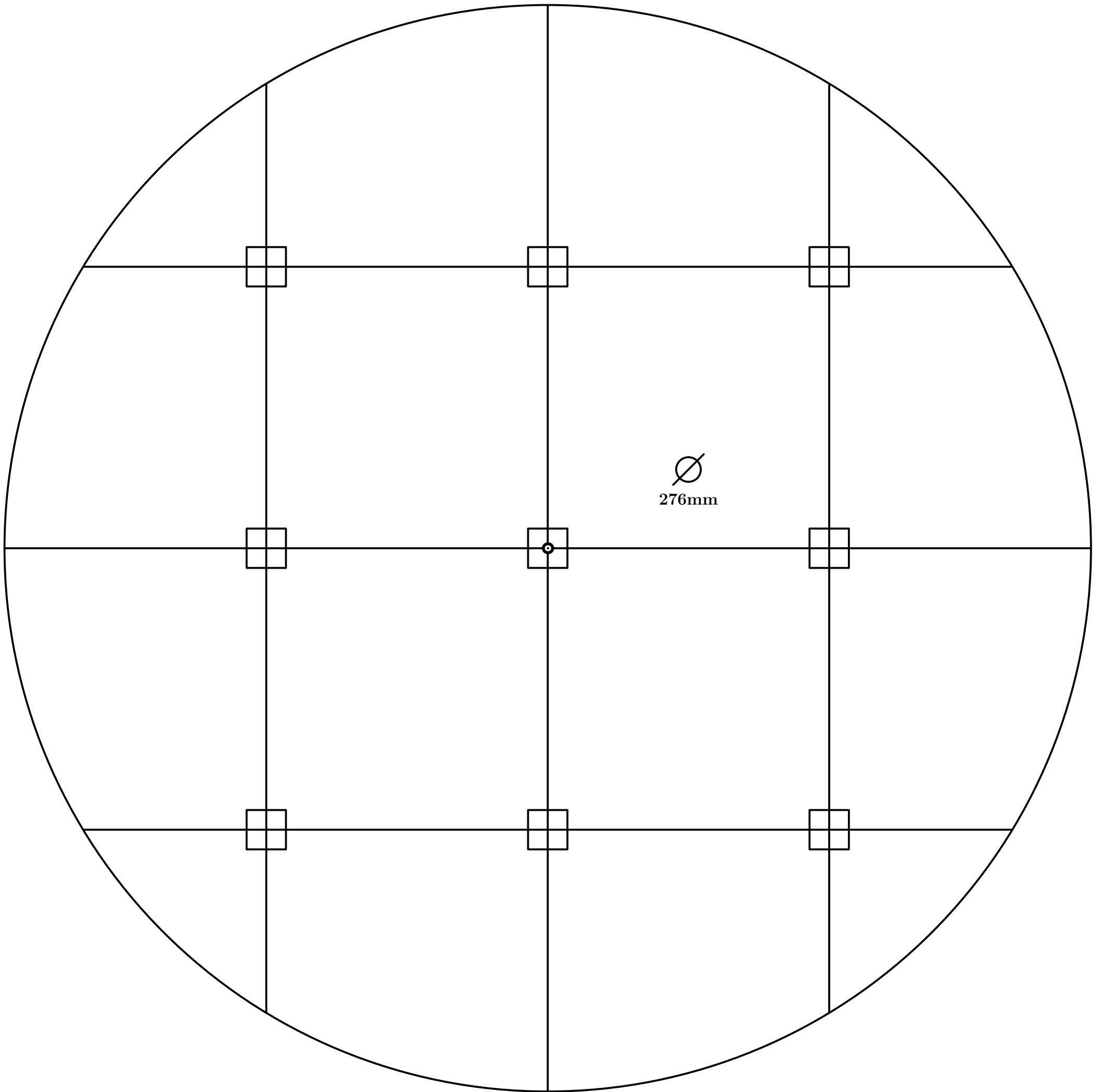

Fig. 705

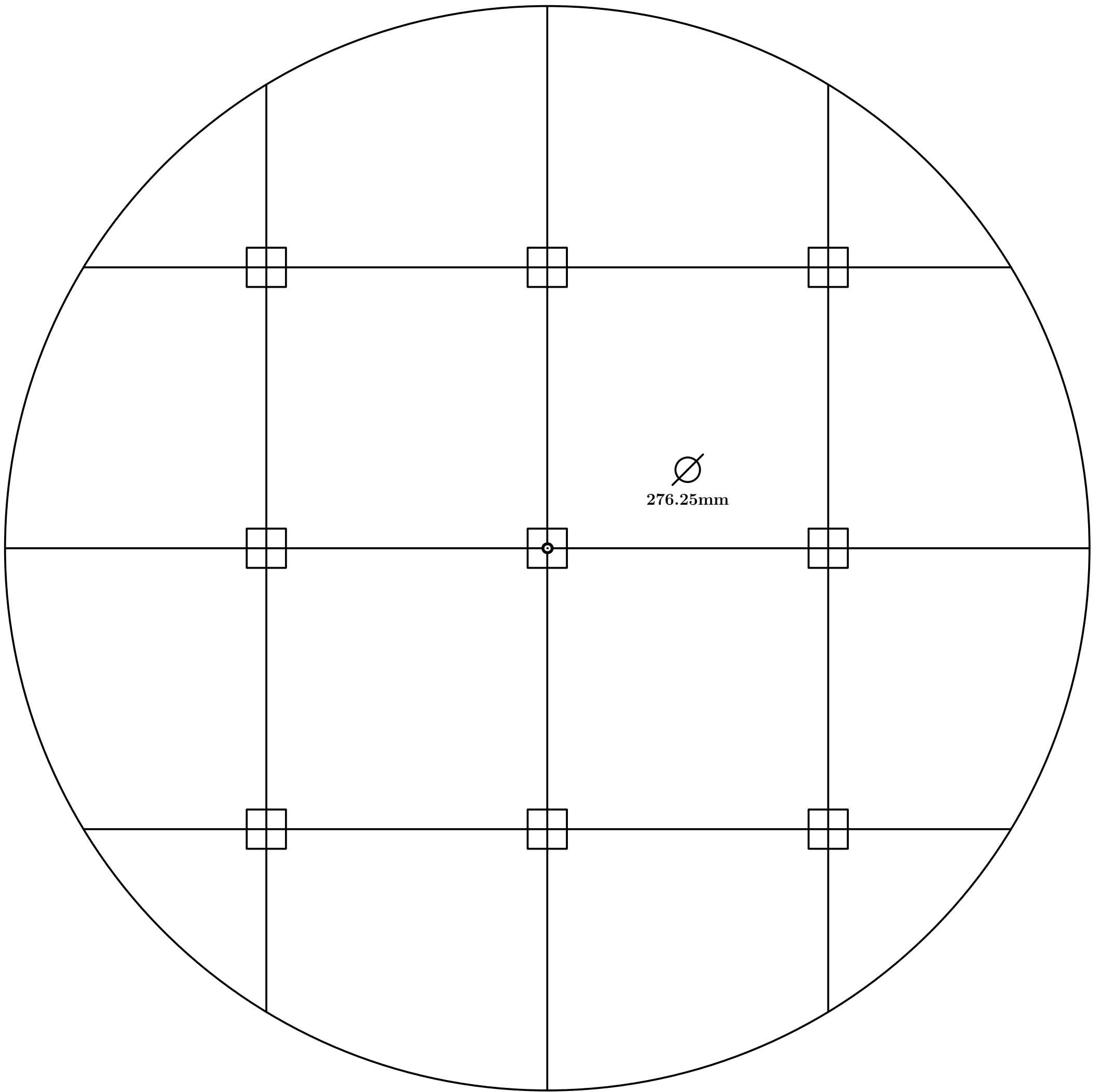

Fig. 706

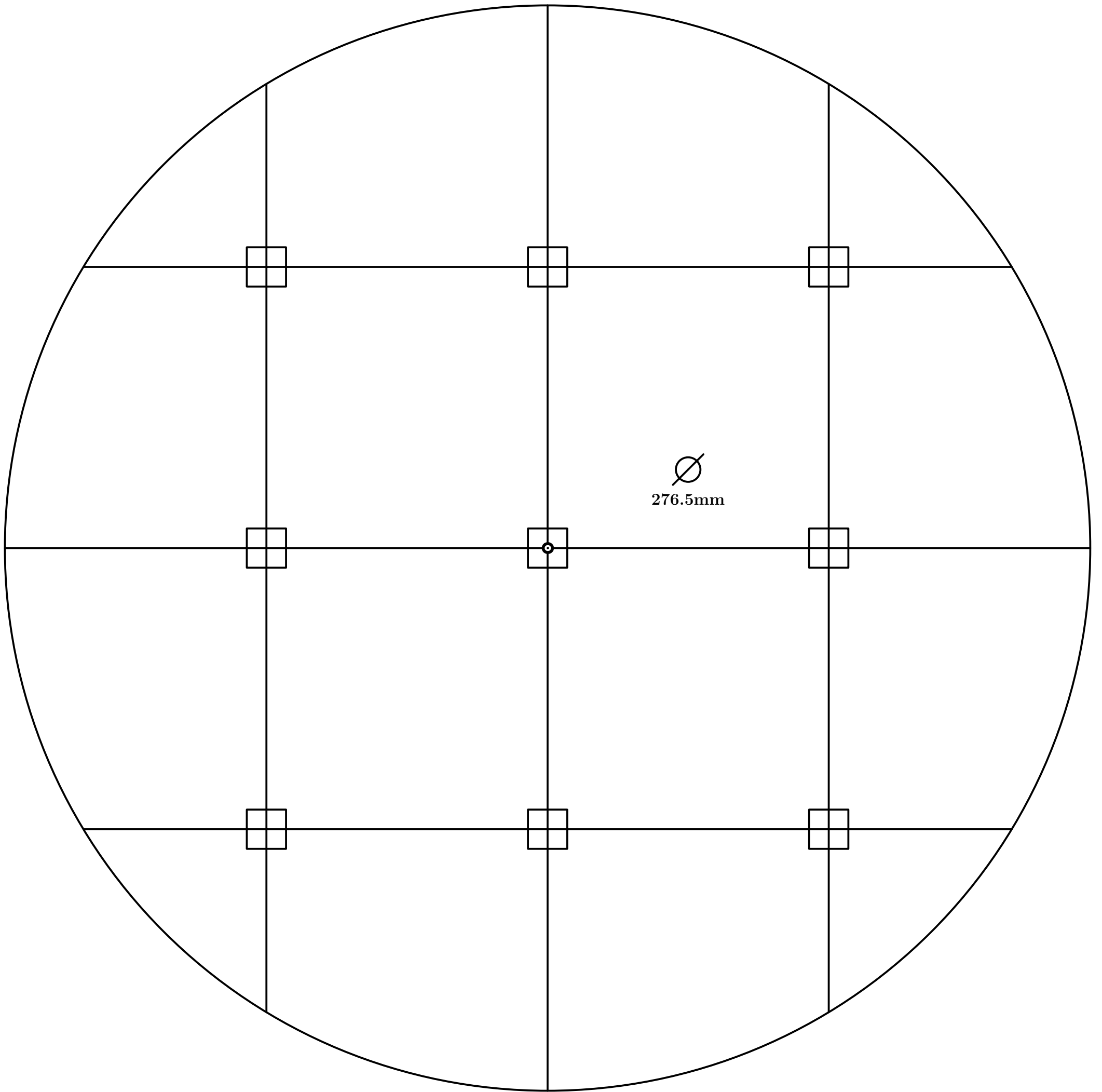

Fig. 707

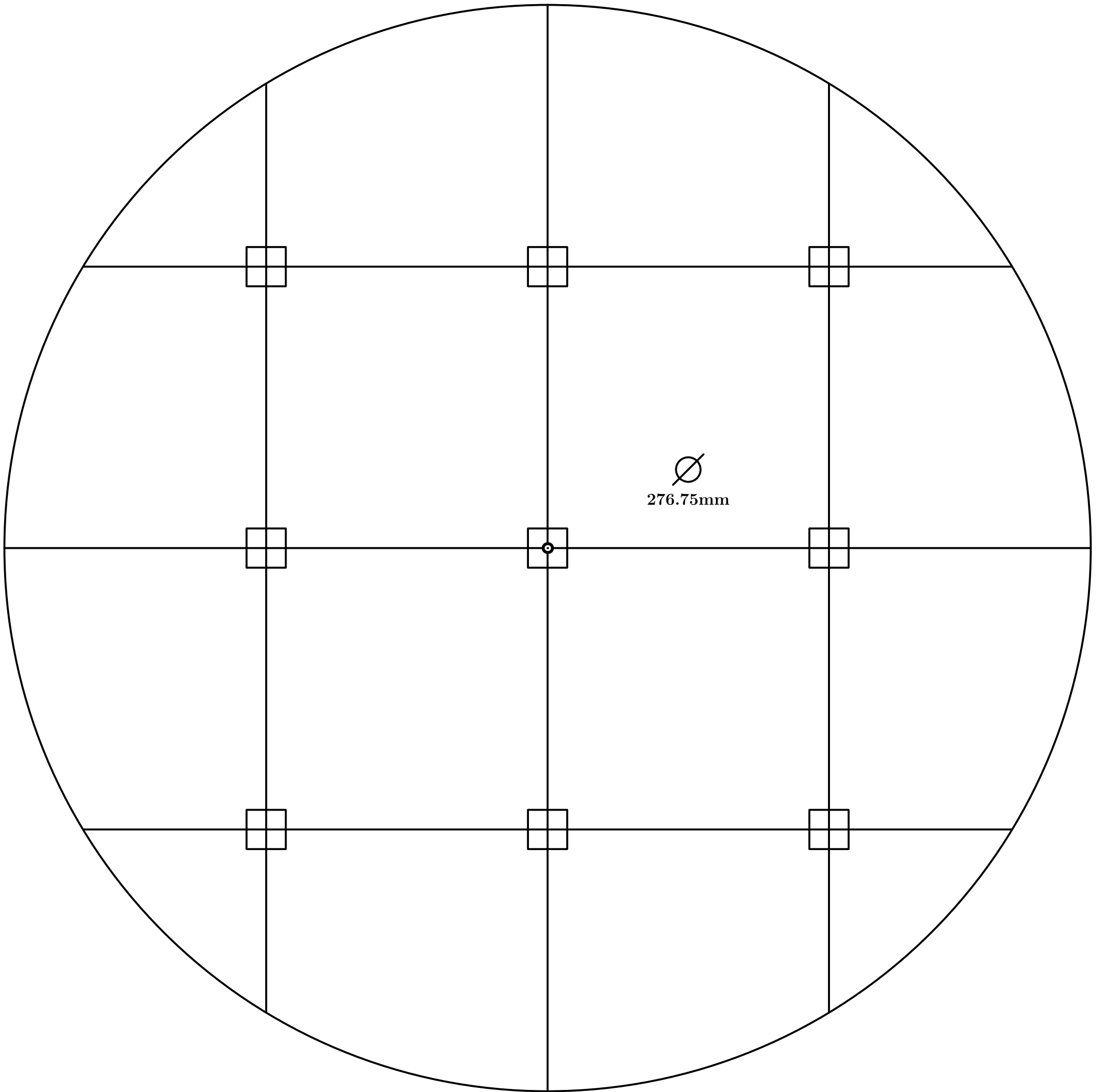

Fig. 708

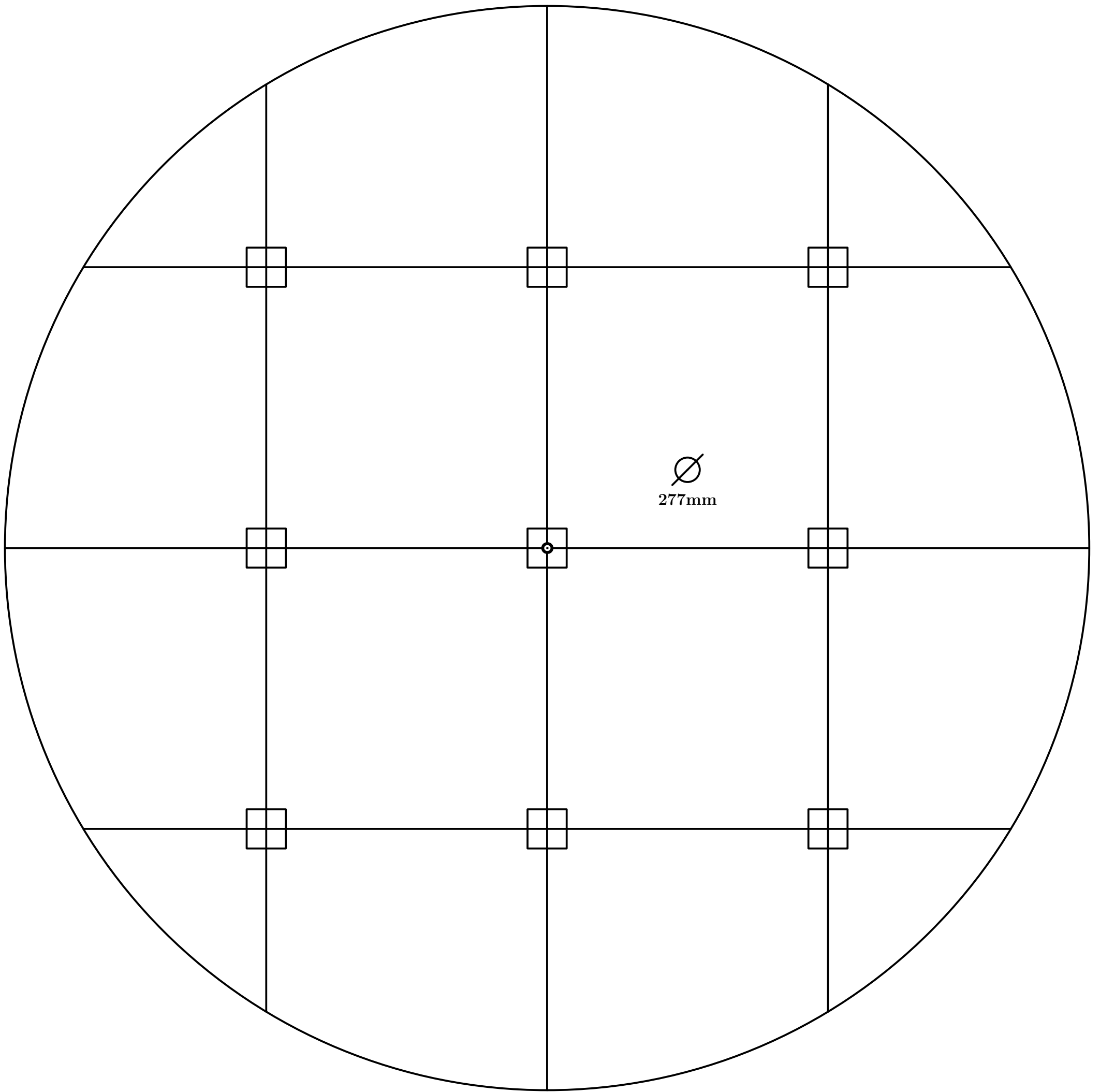

Fig. 709

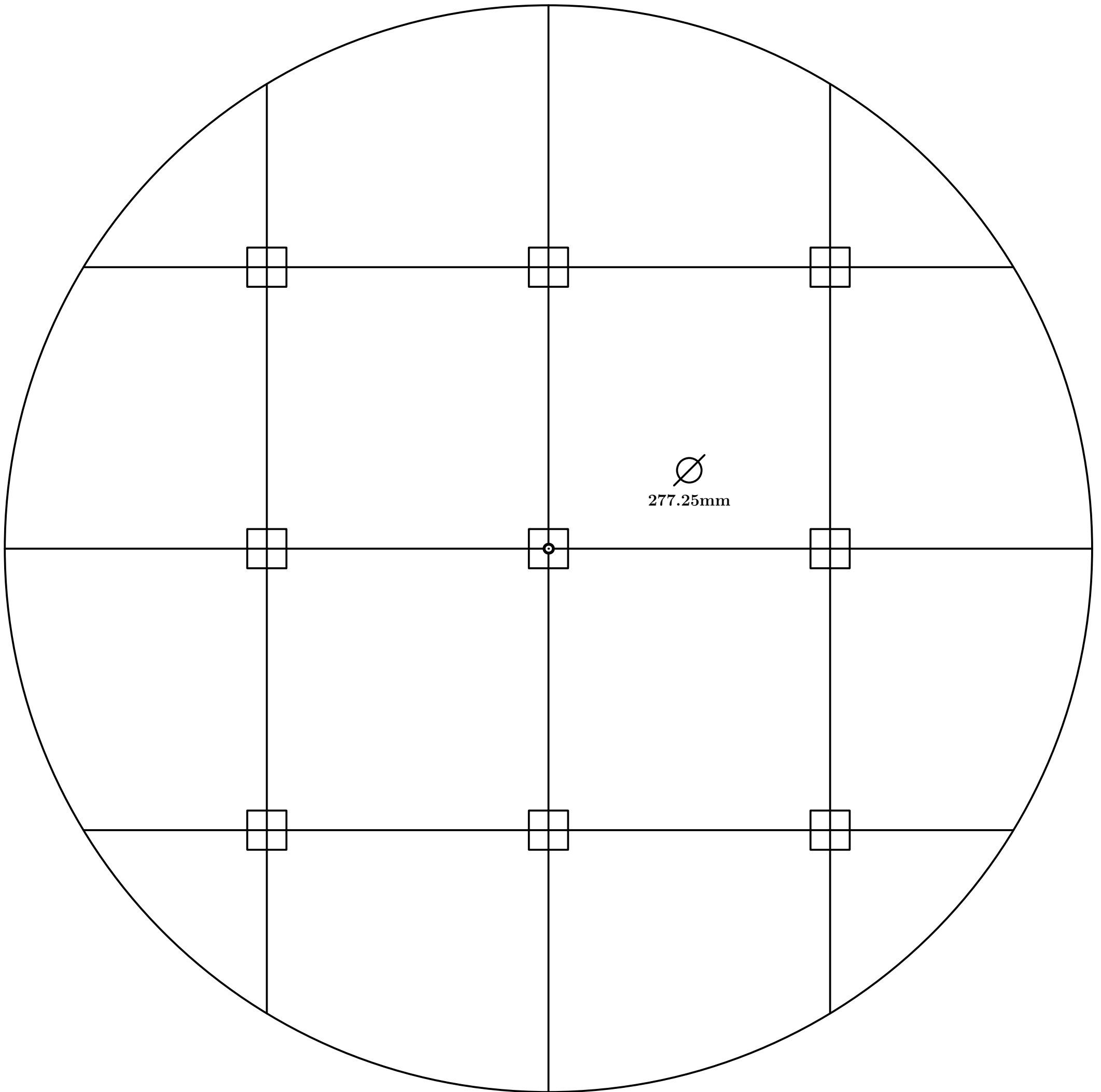

Fig. 710

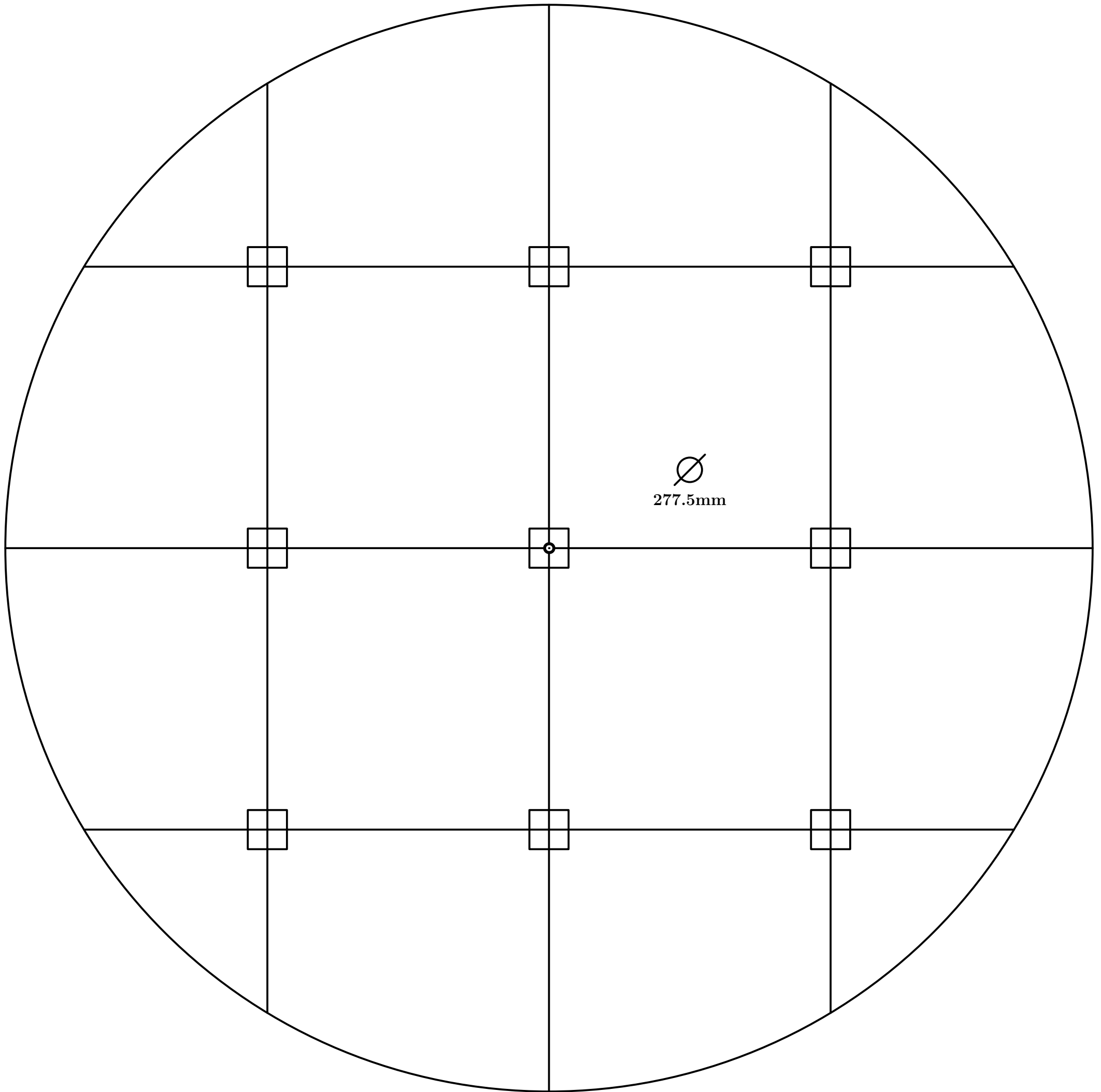

Fig. 711

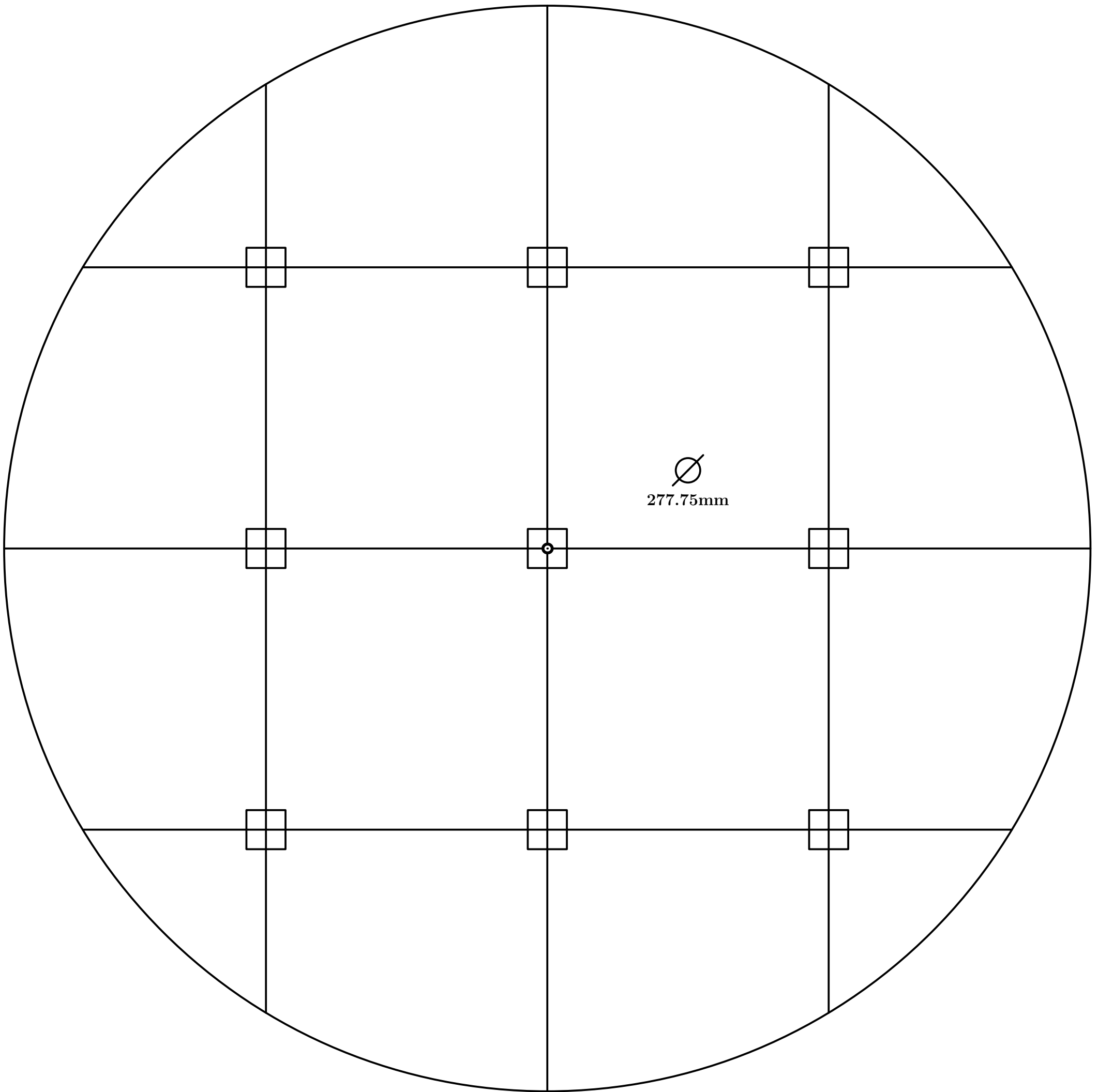

Fig. 712

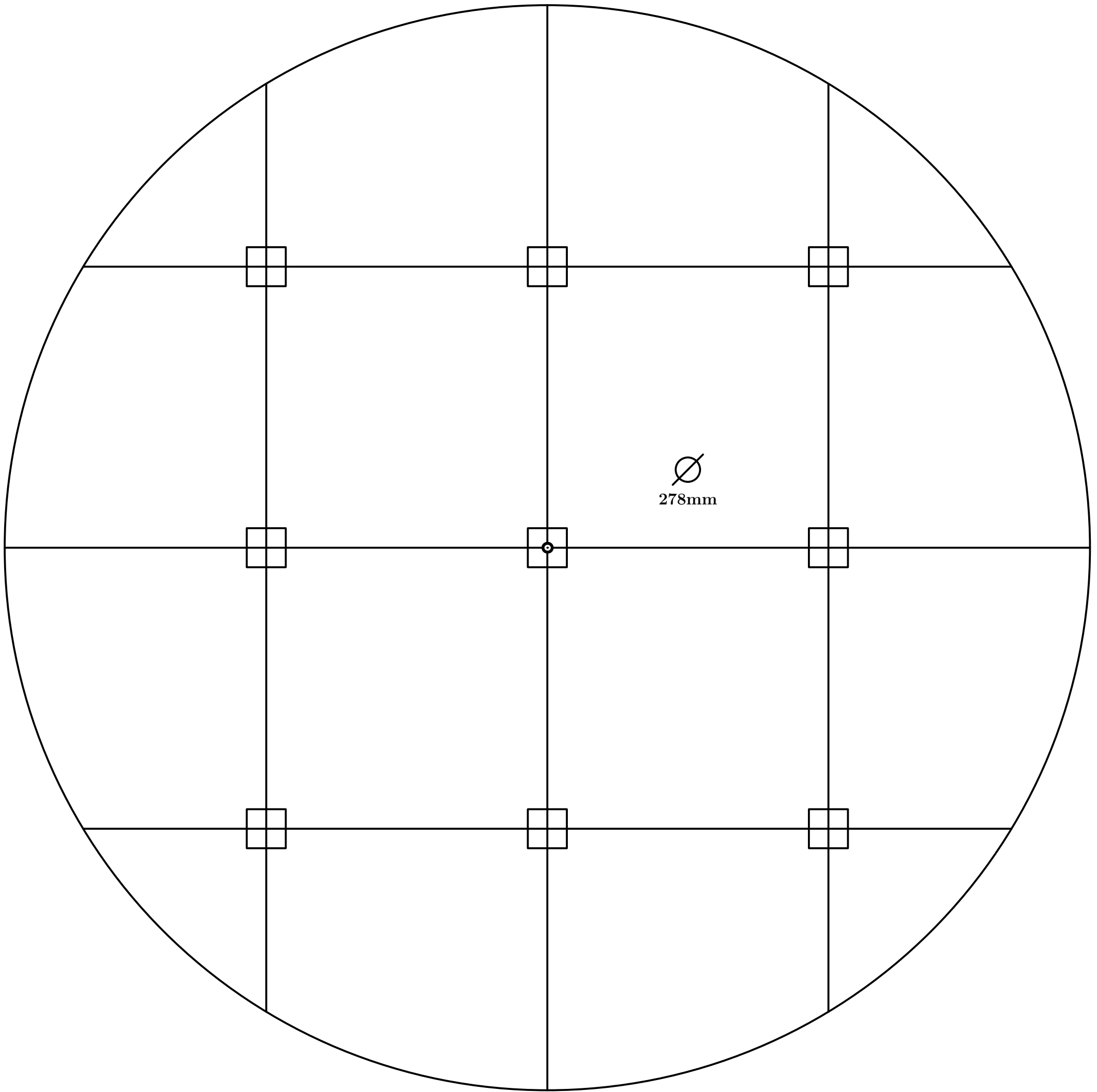

Fig. 713

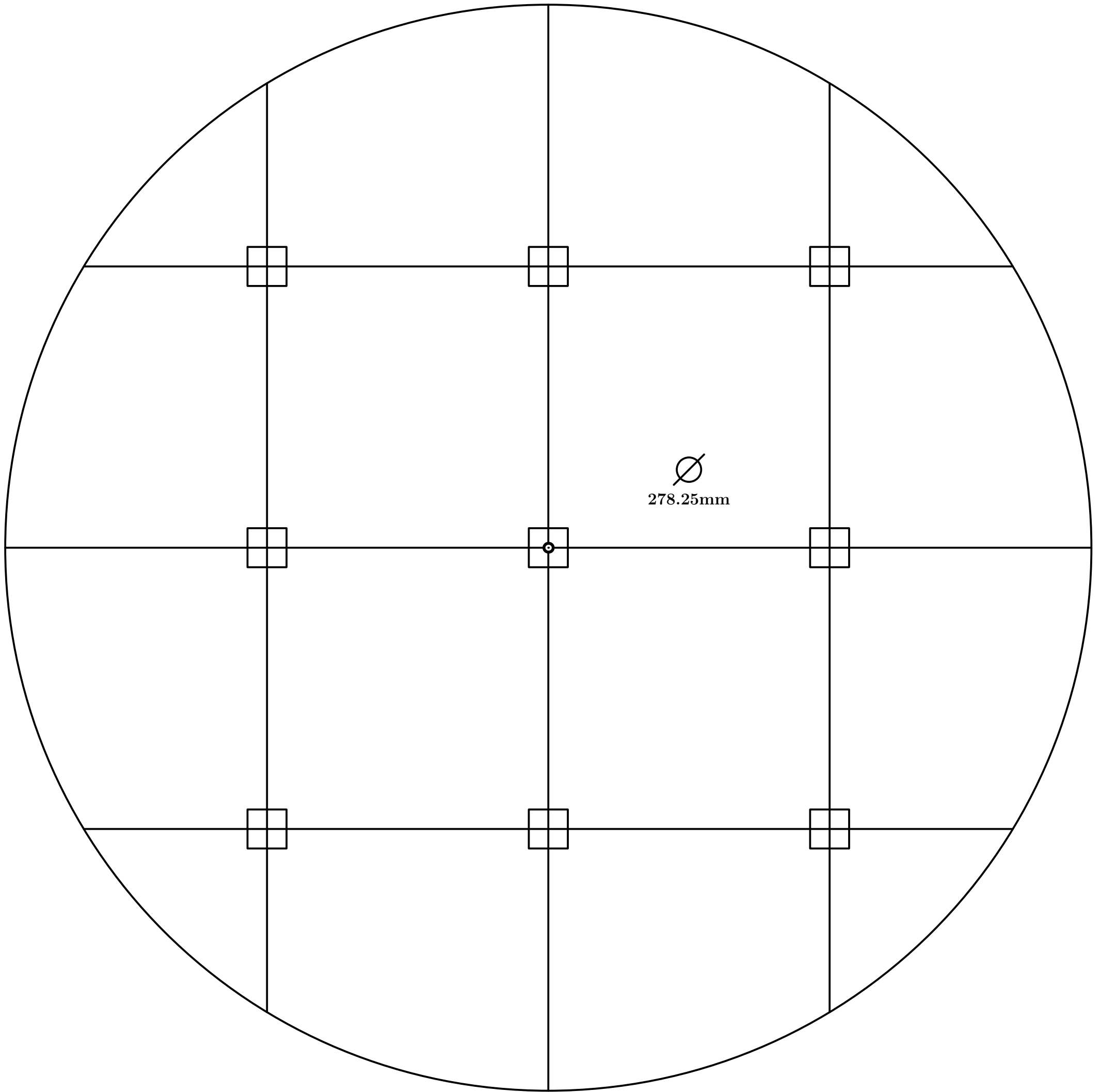

Fig. 714

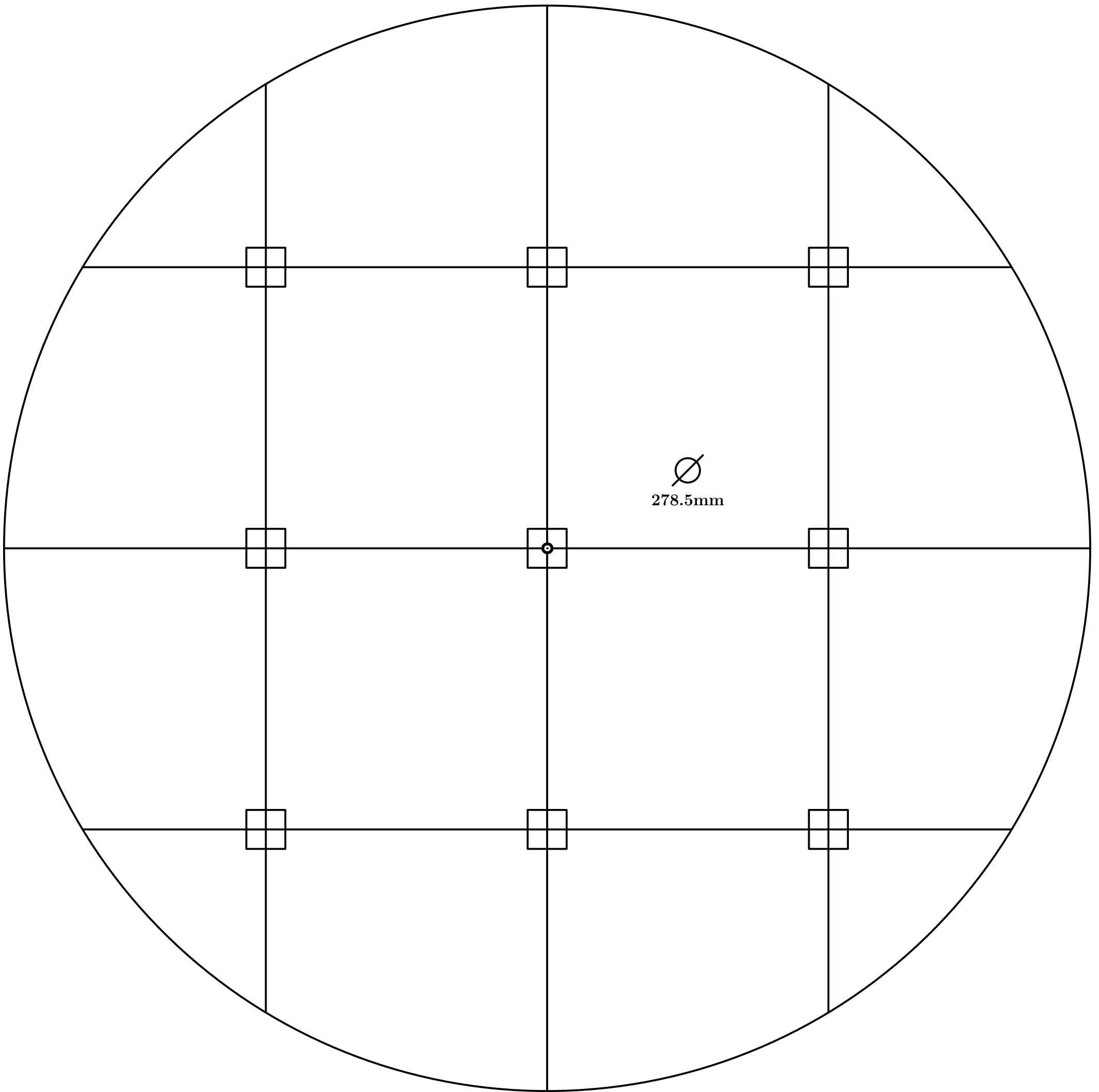

Fig. 715

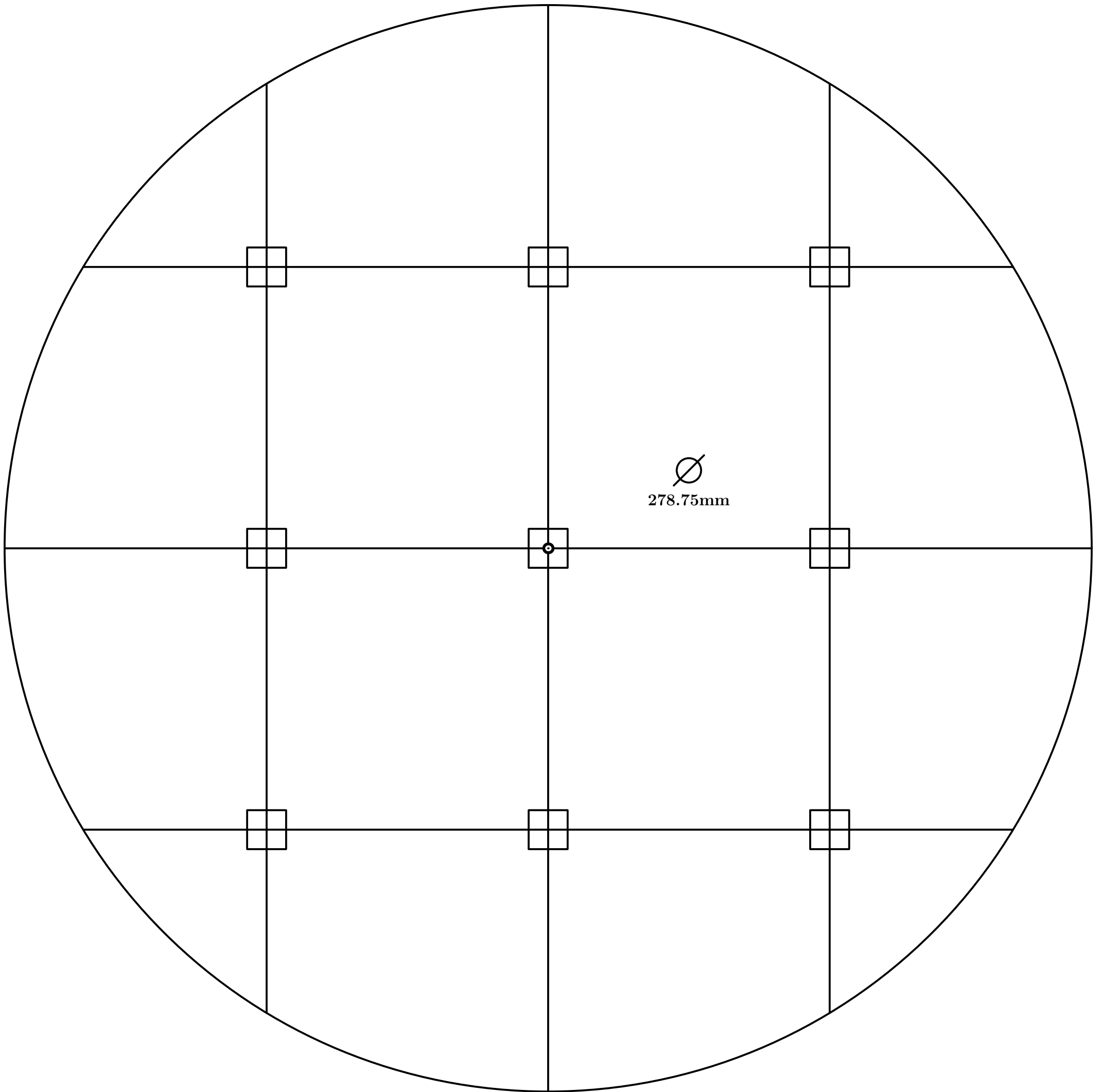

Fig. 716

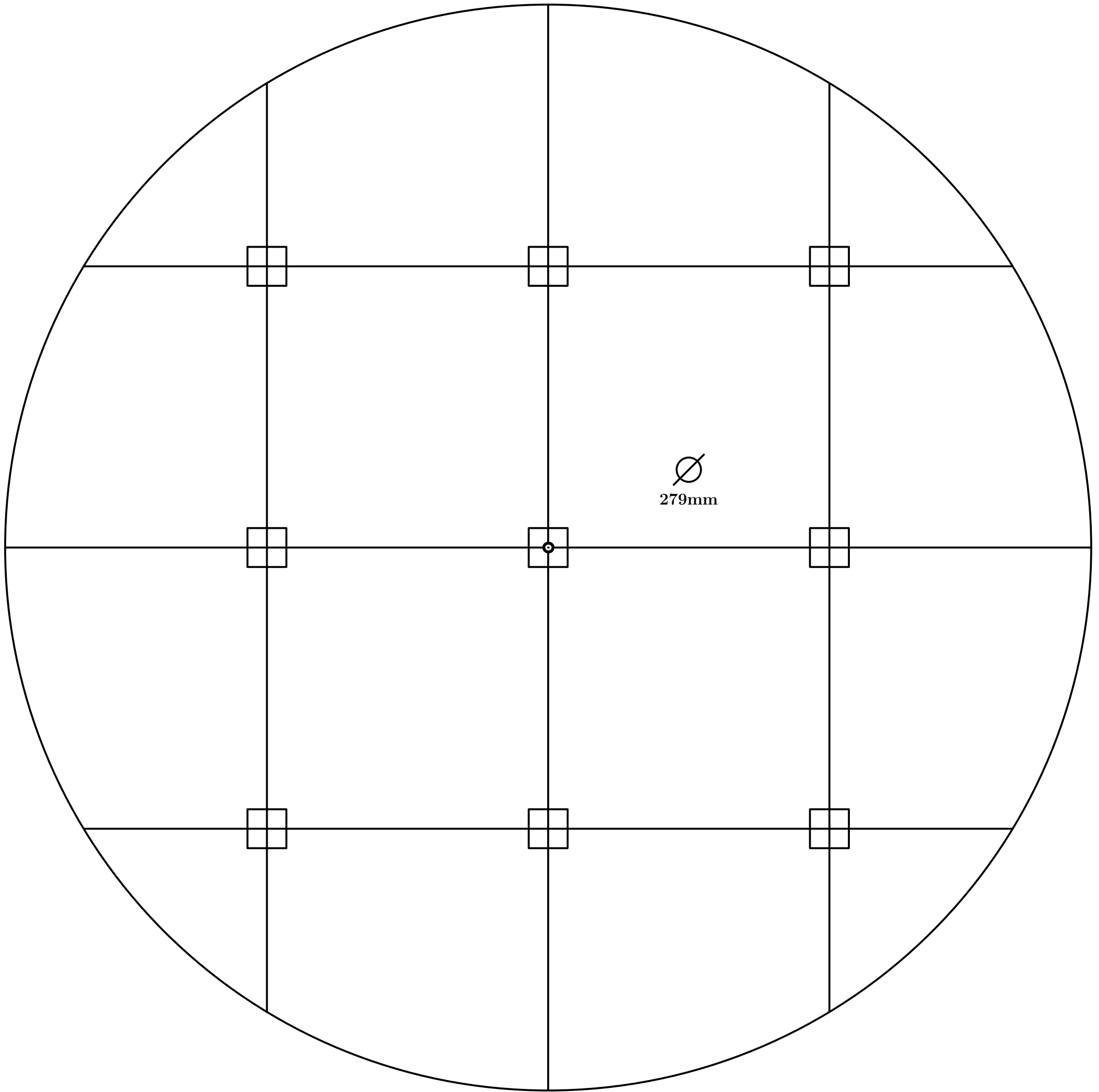

Fig. 717

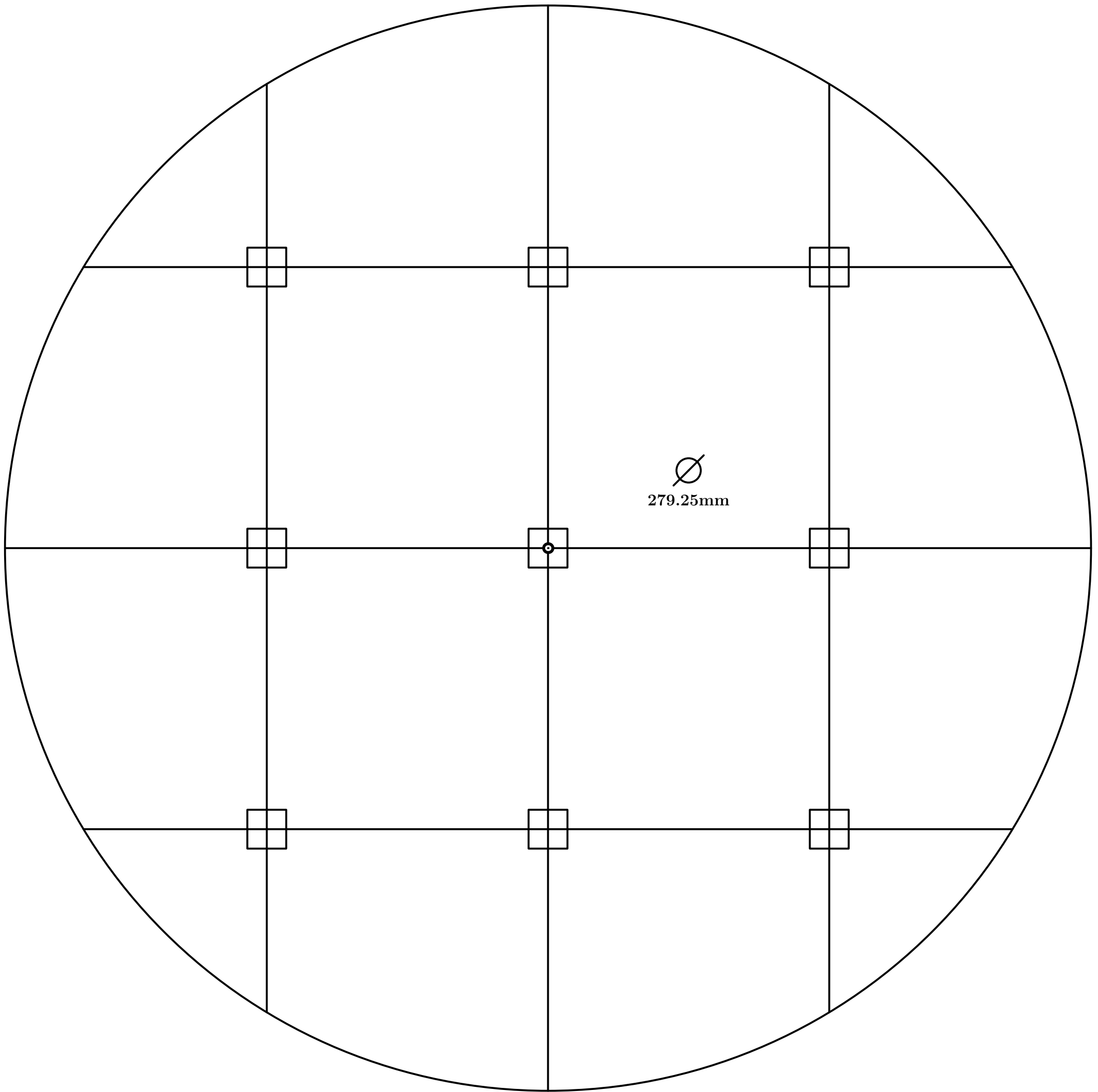

Fig. 718

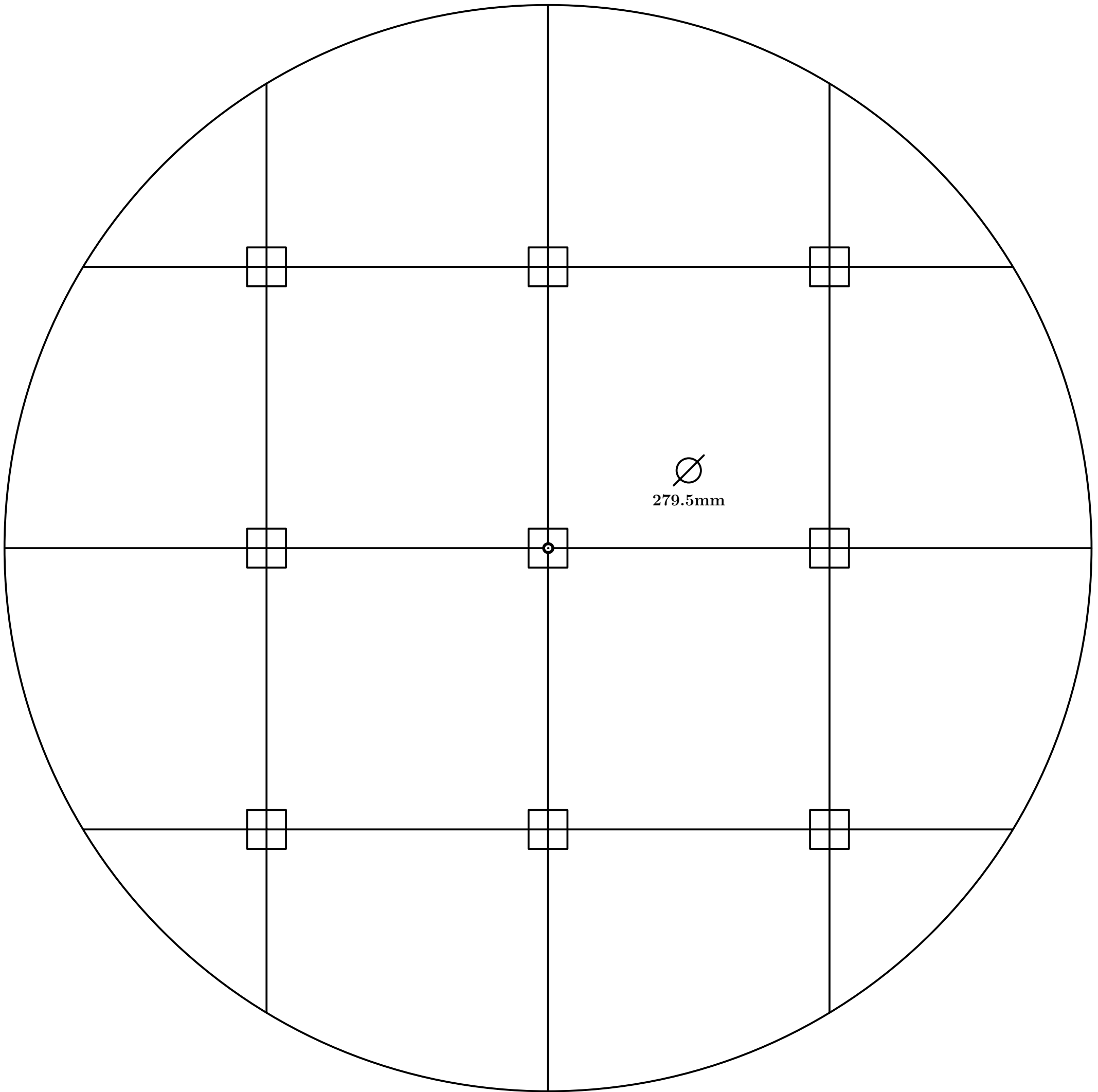

Fig. 719

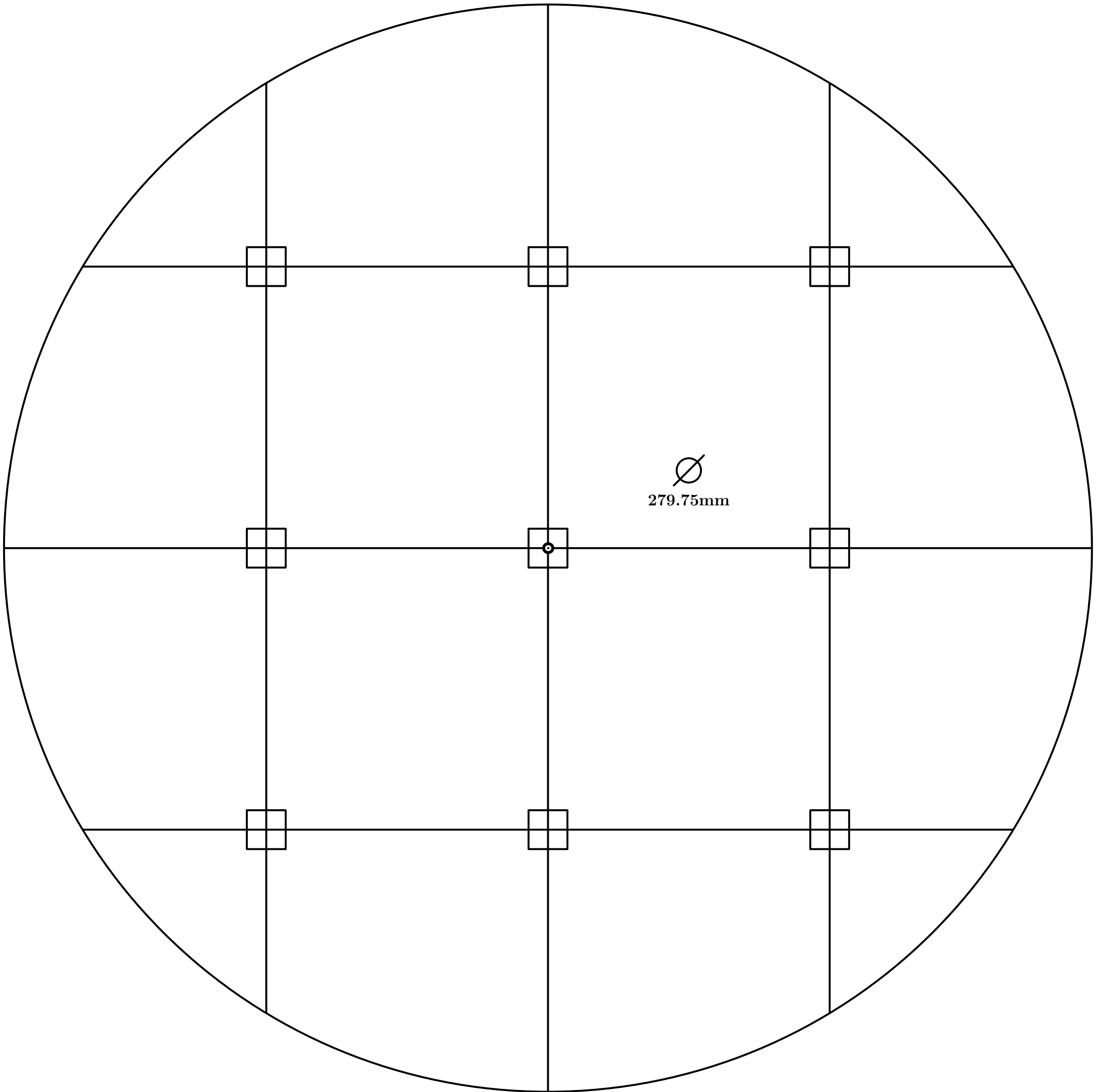

Fig. 720

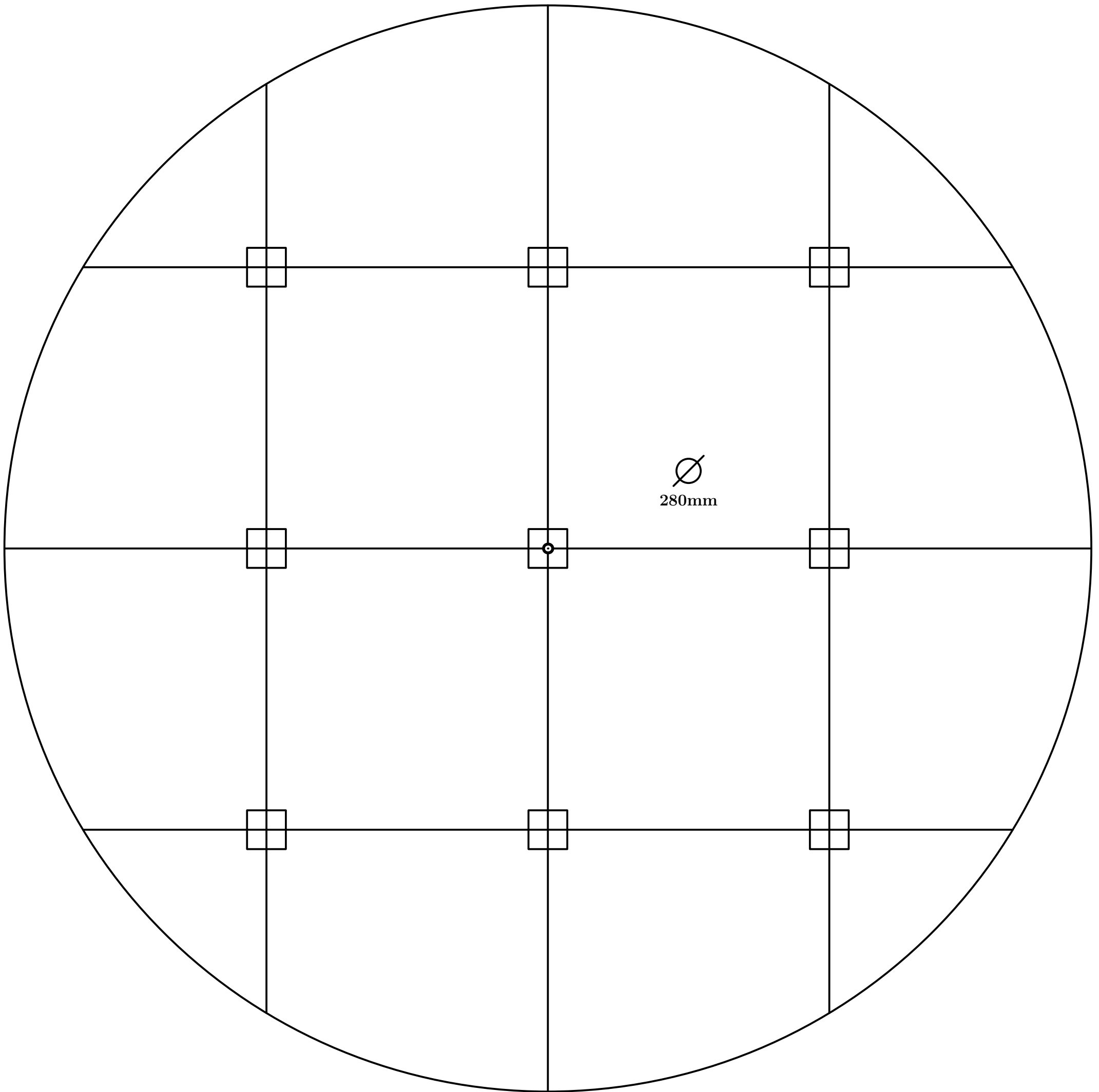

Fig. 721

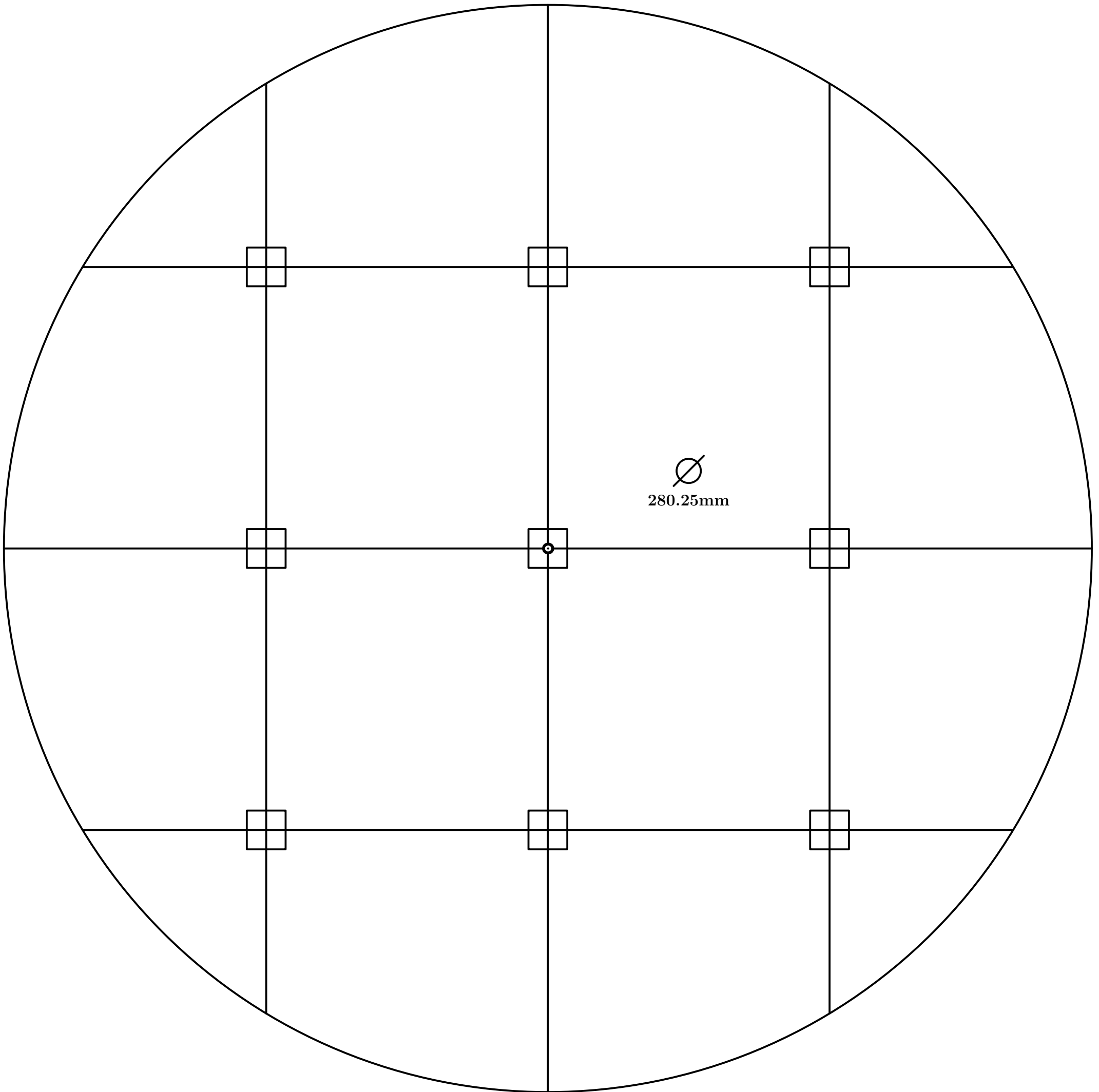

Fig. 722

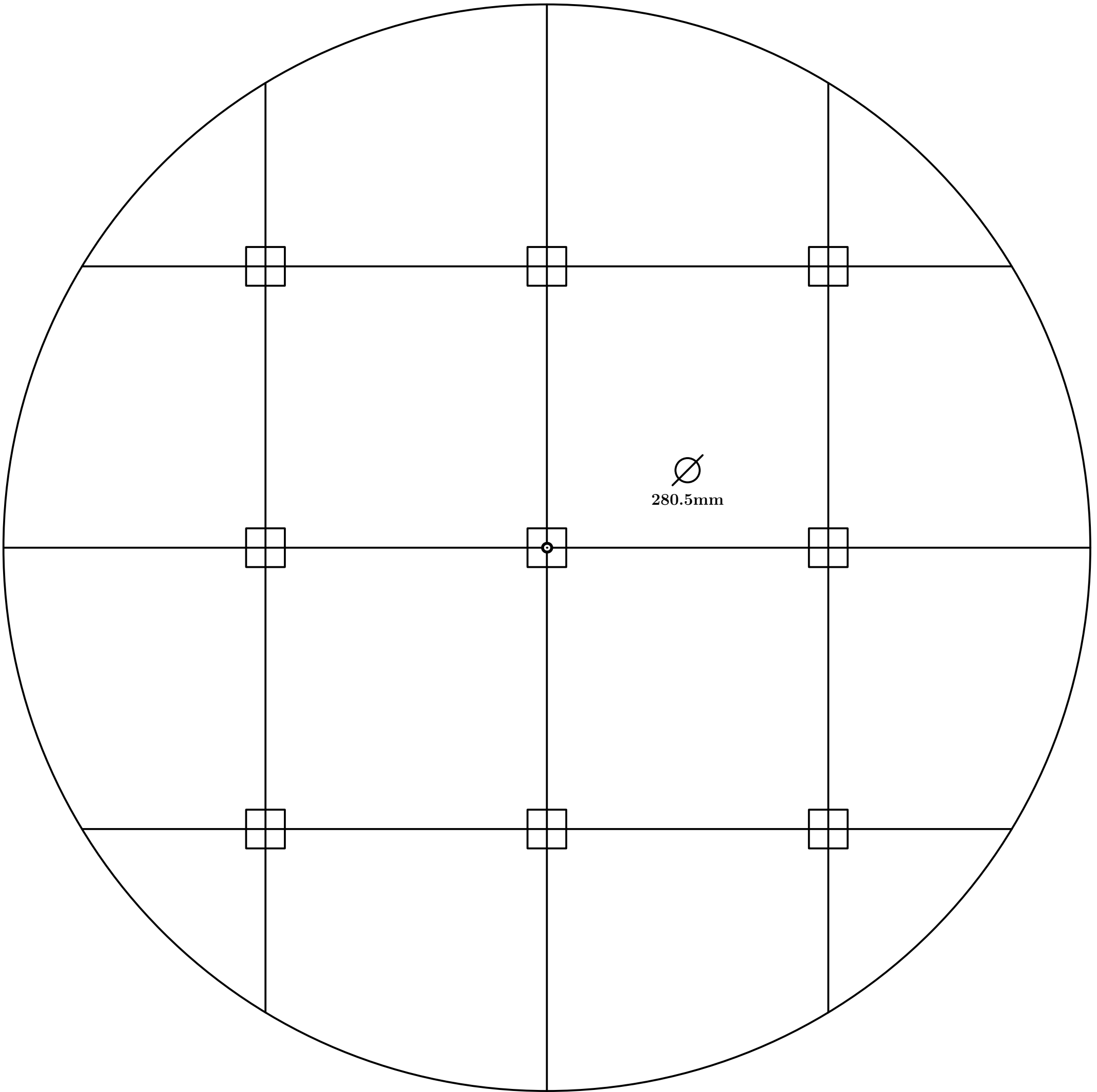

Fig. 723

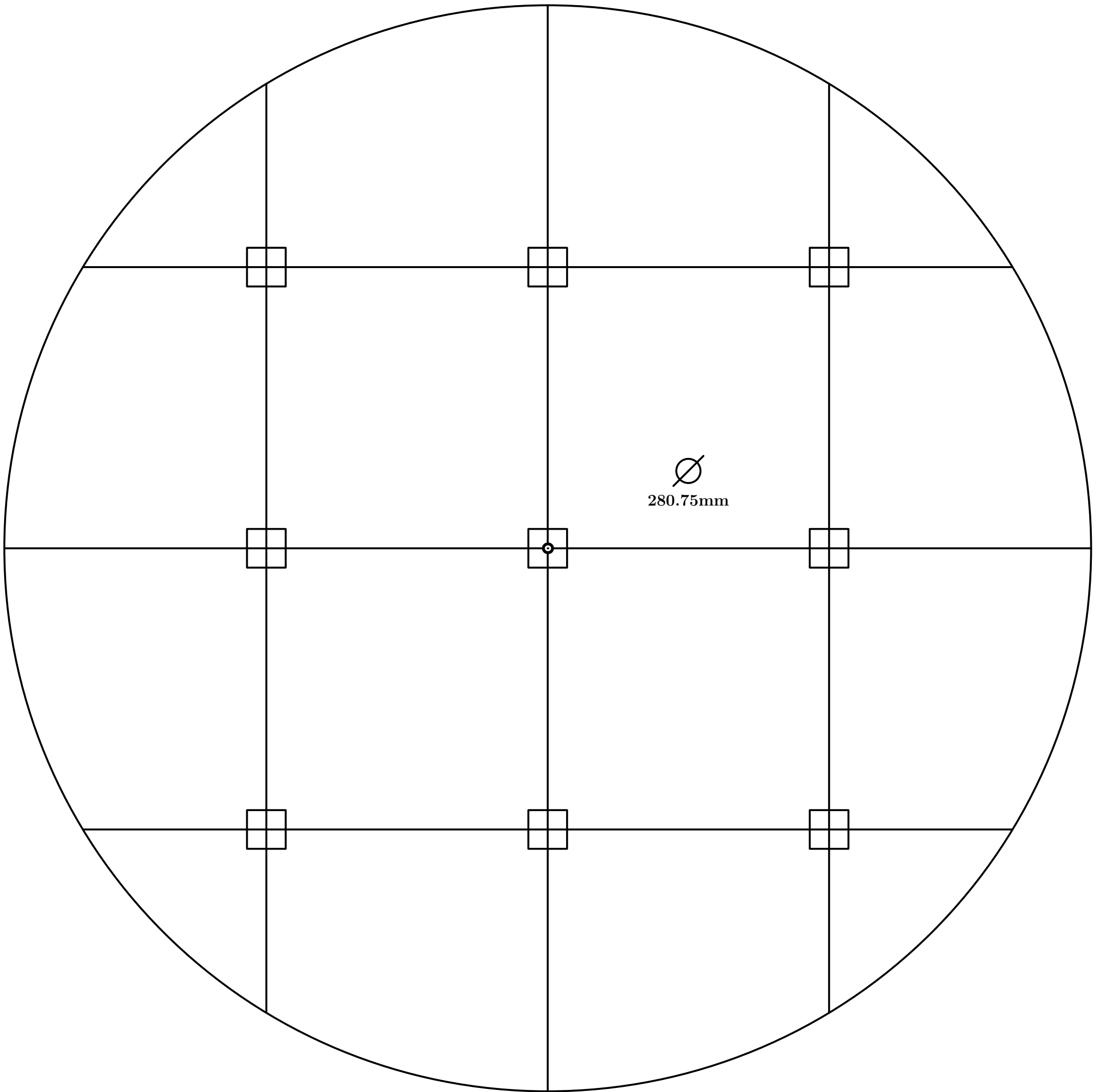

Fig. 724

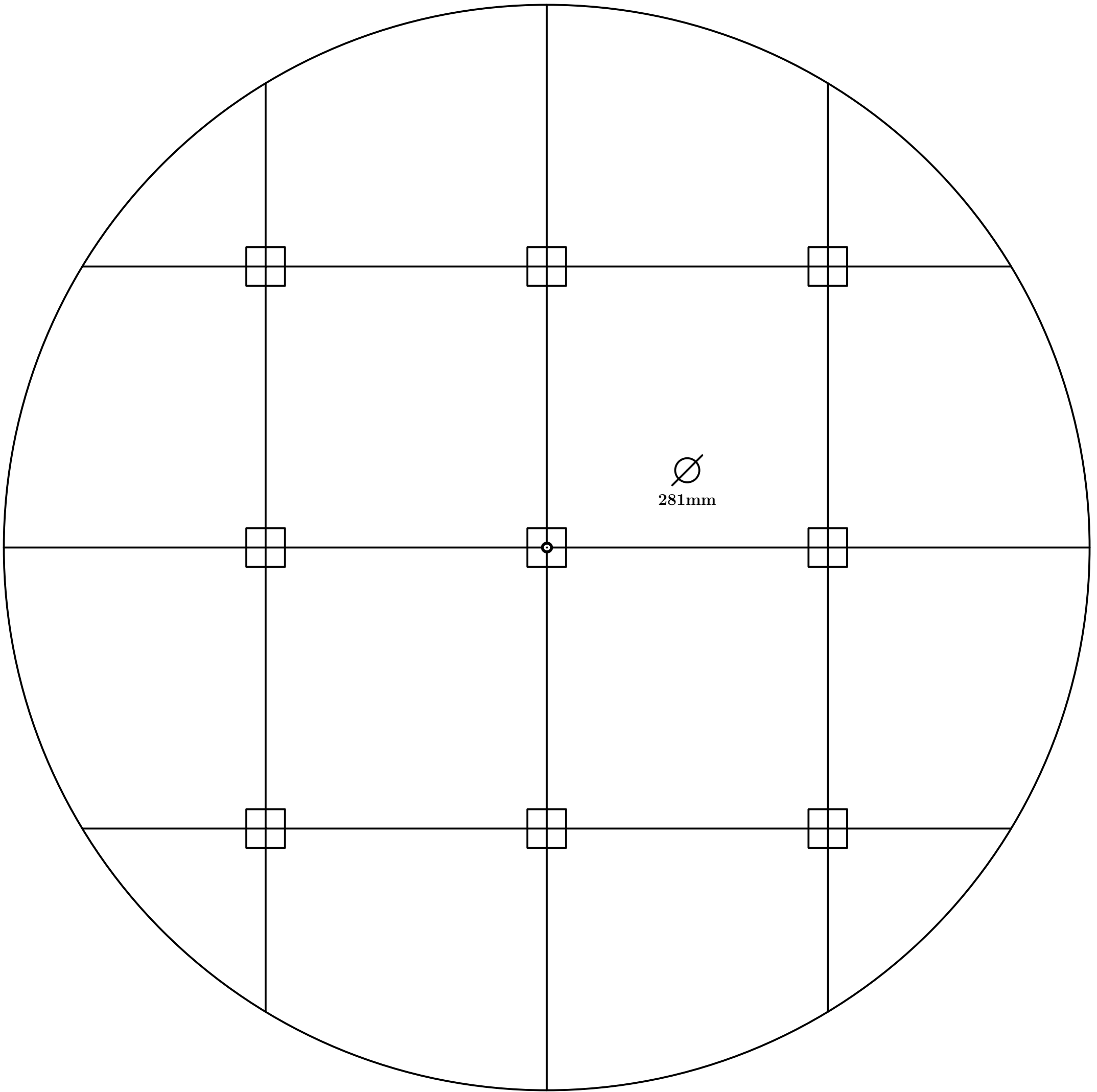

Fig. 725

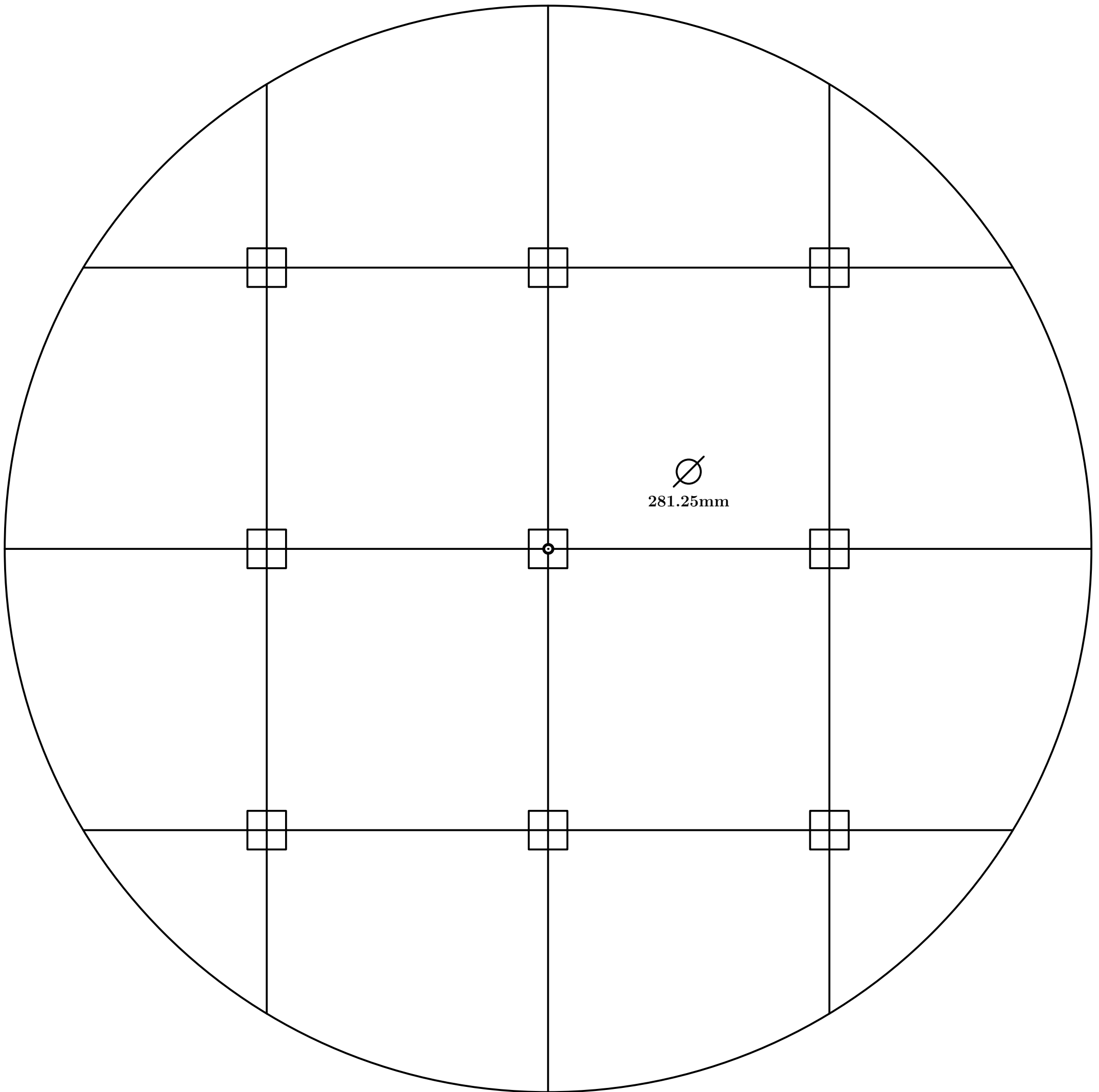

Fig. 726

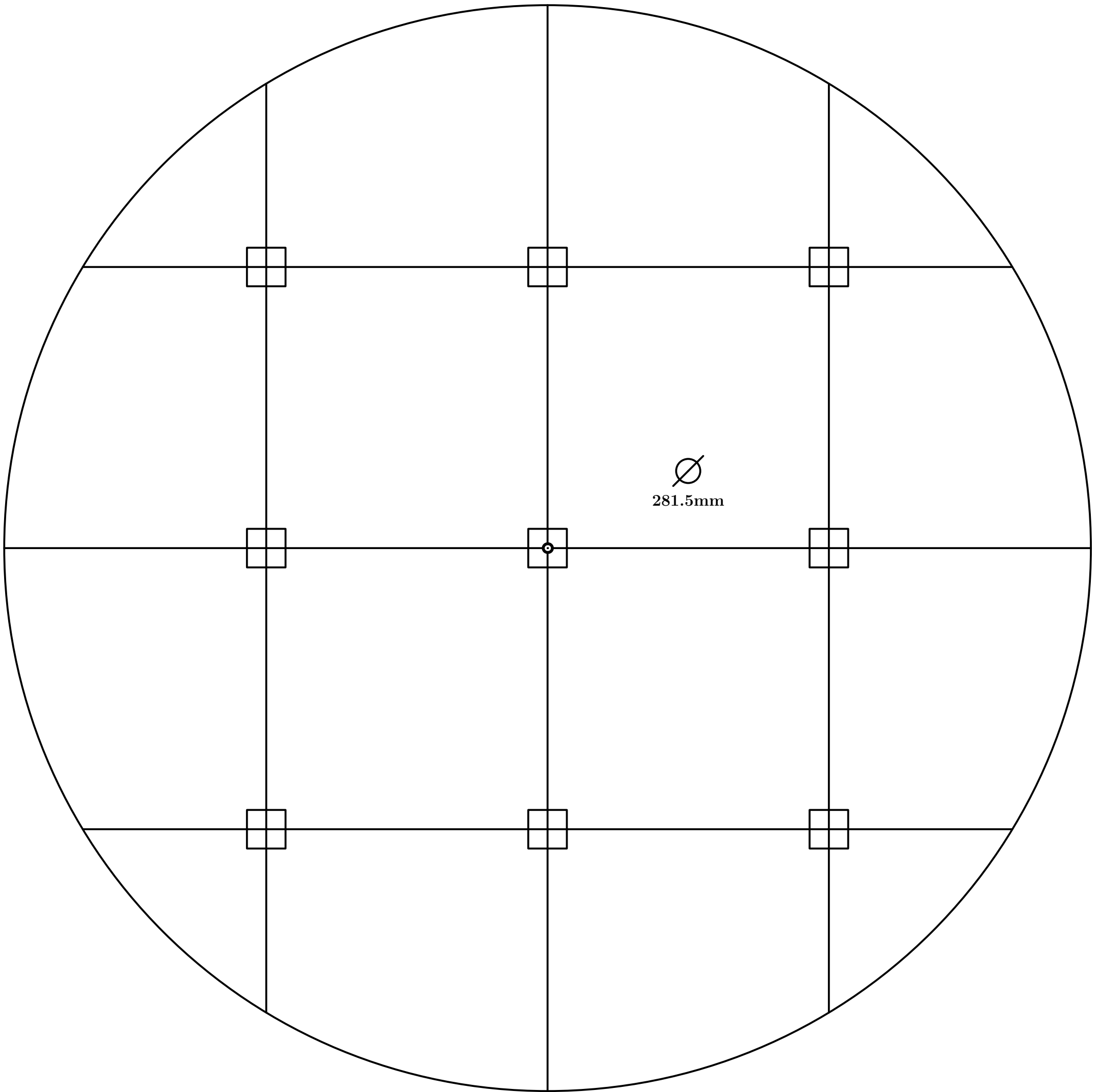

Fig. 727

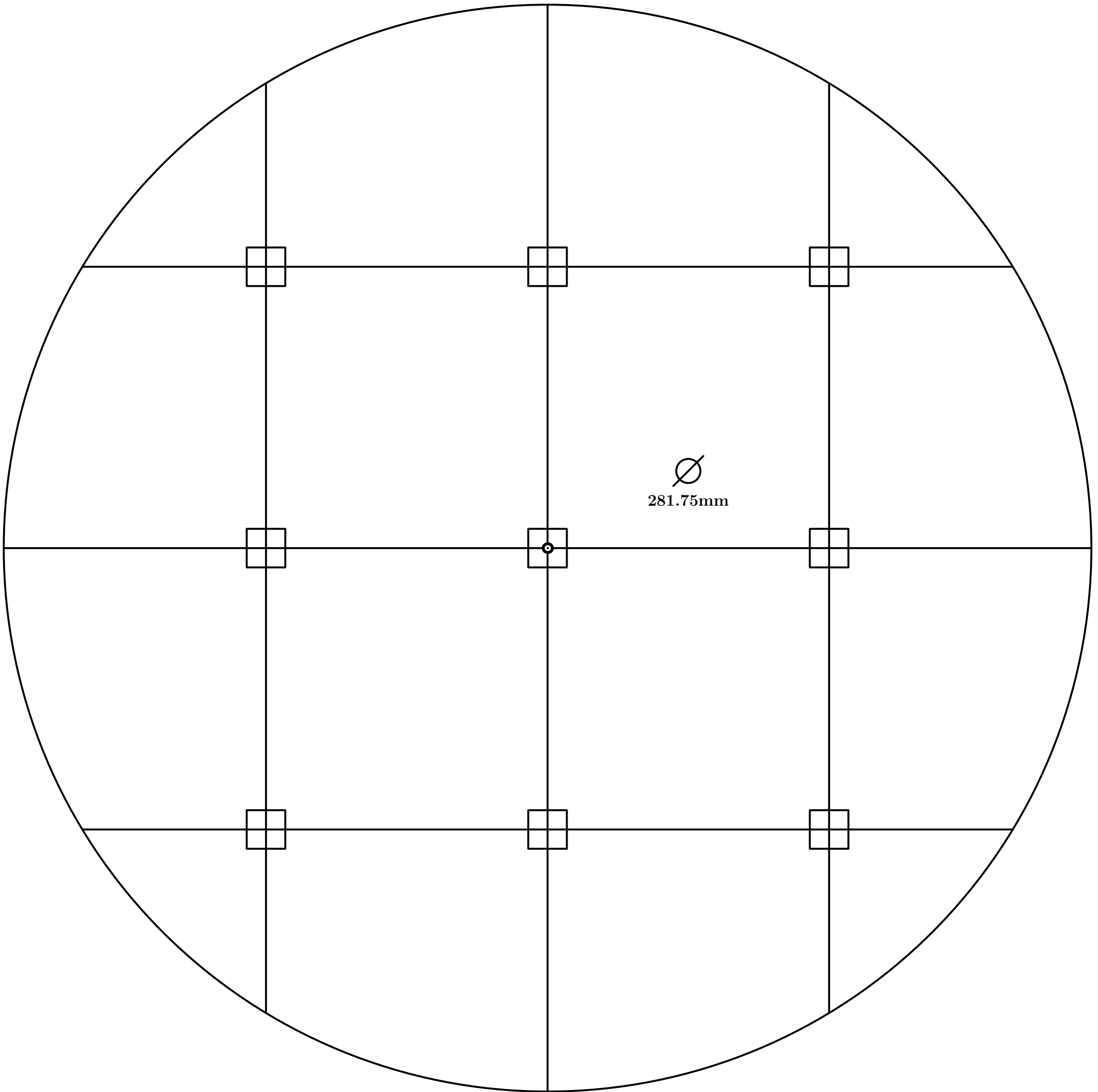

Fig. 728

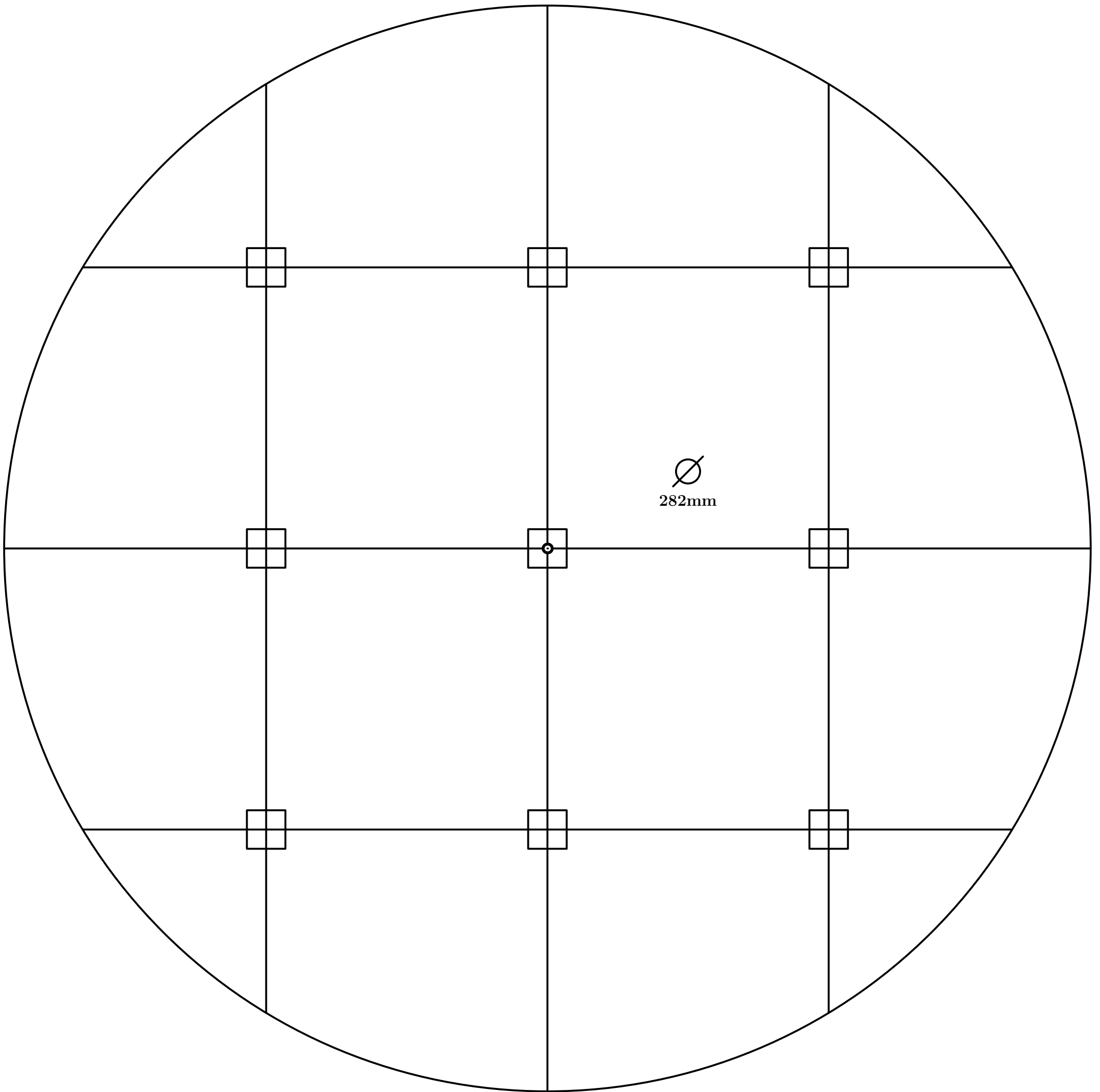

Fig. 729

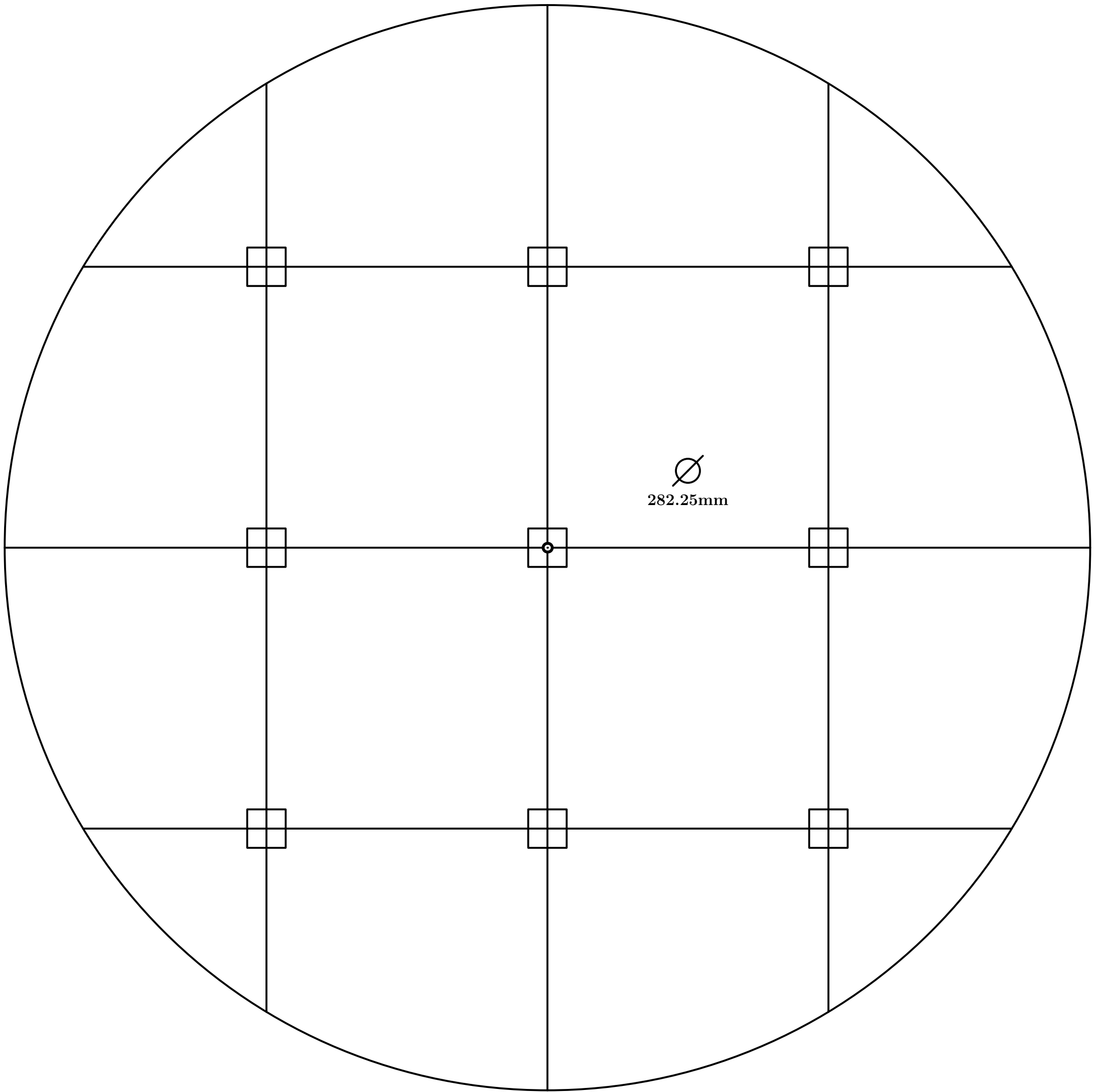

Fig. 730

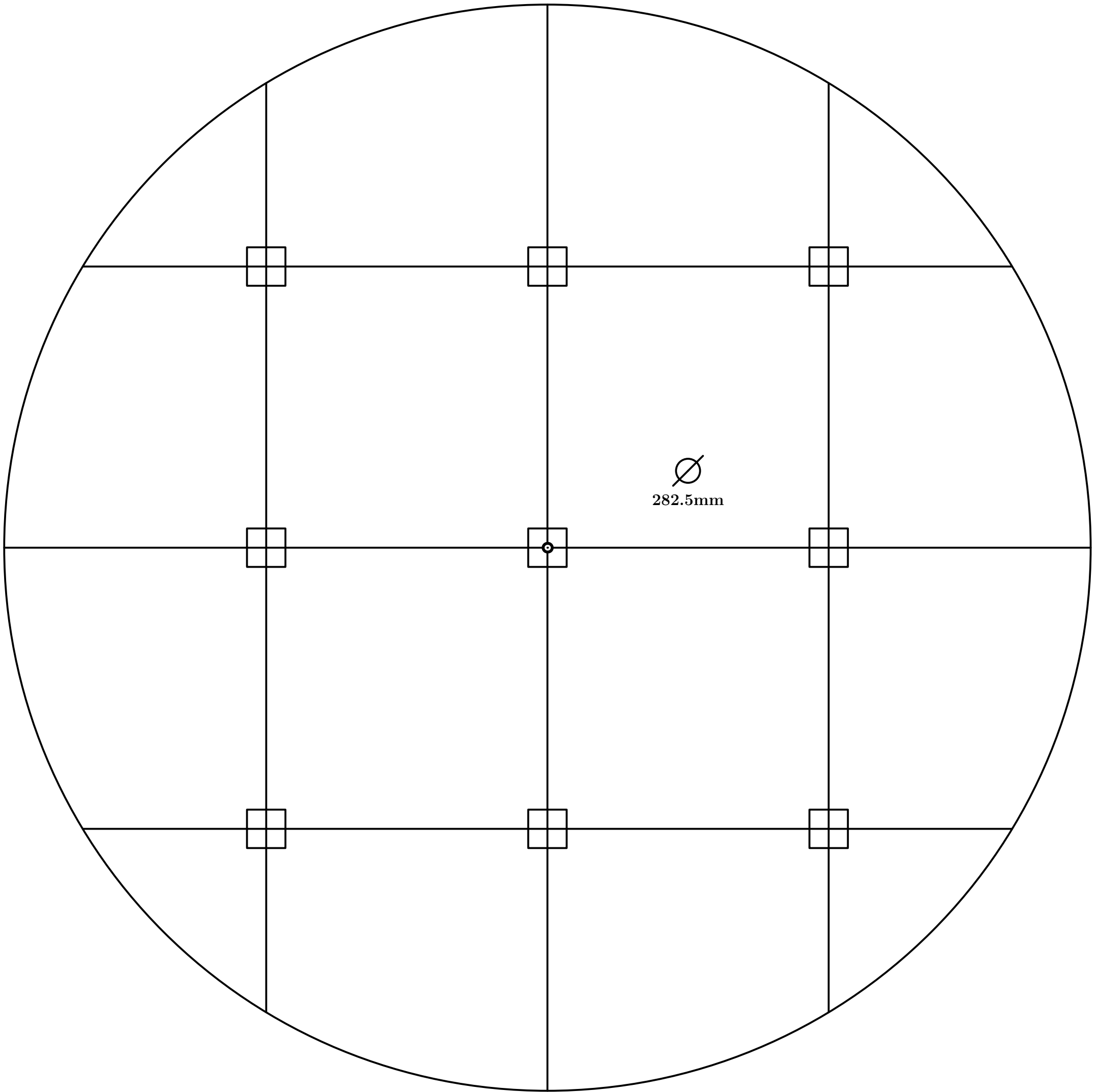

Fig. 731

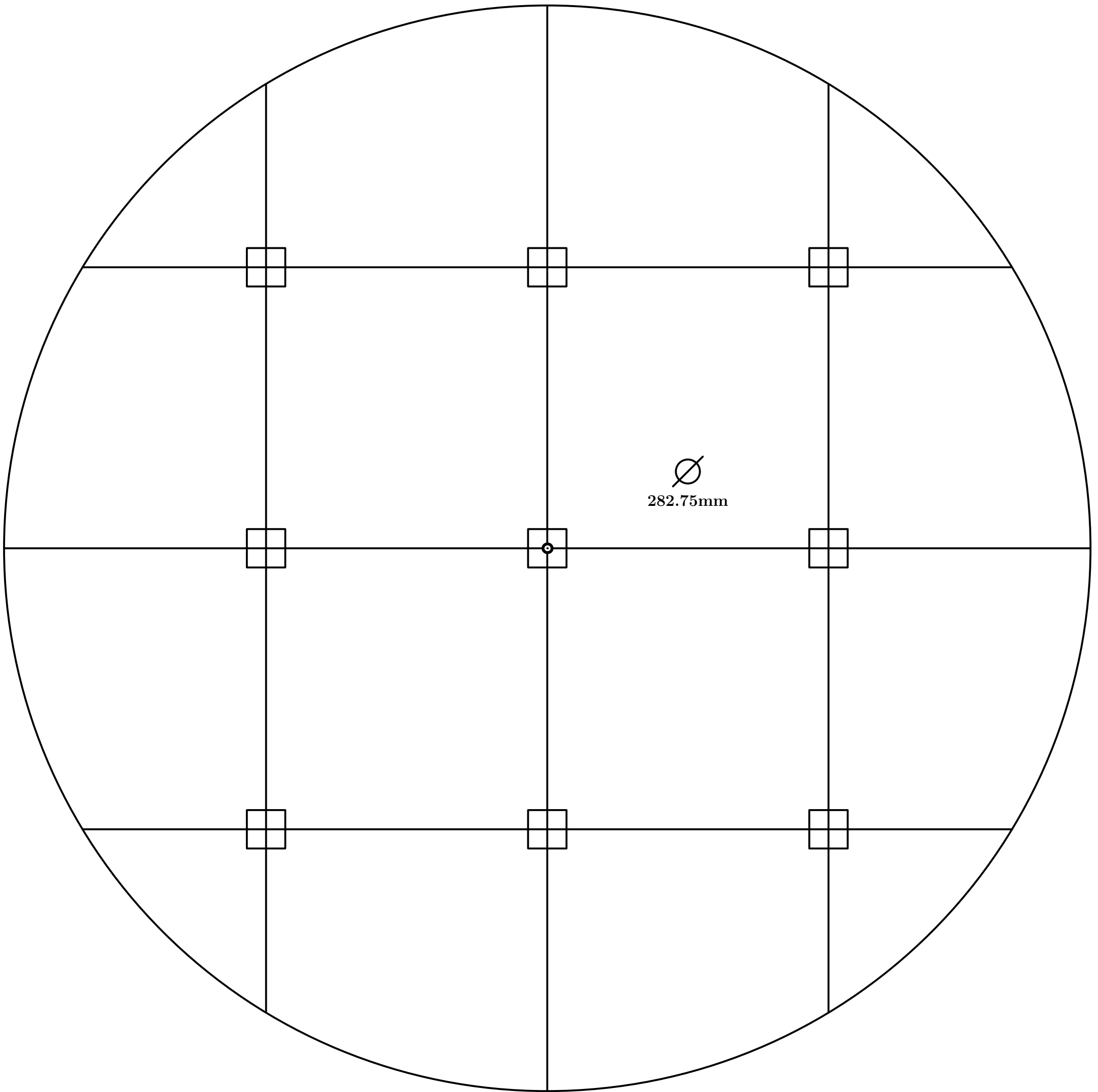

Fig. 732

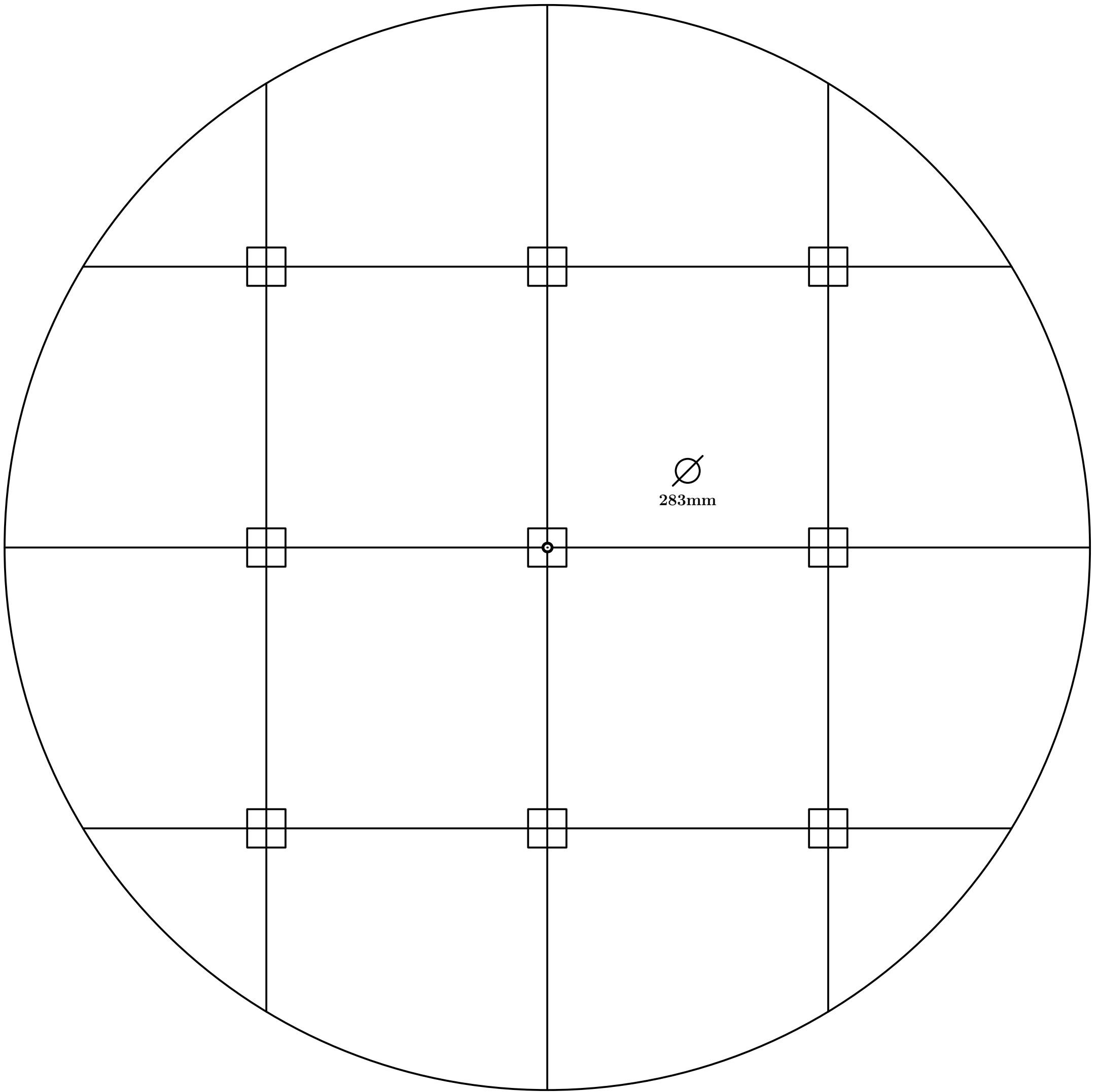

Fig. 733

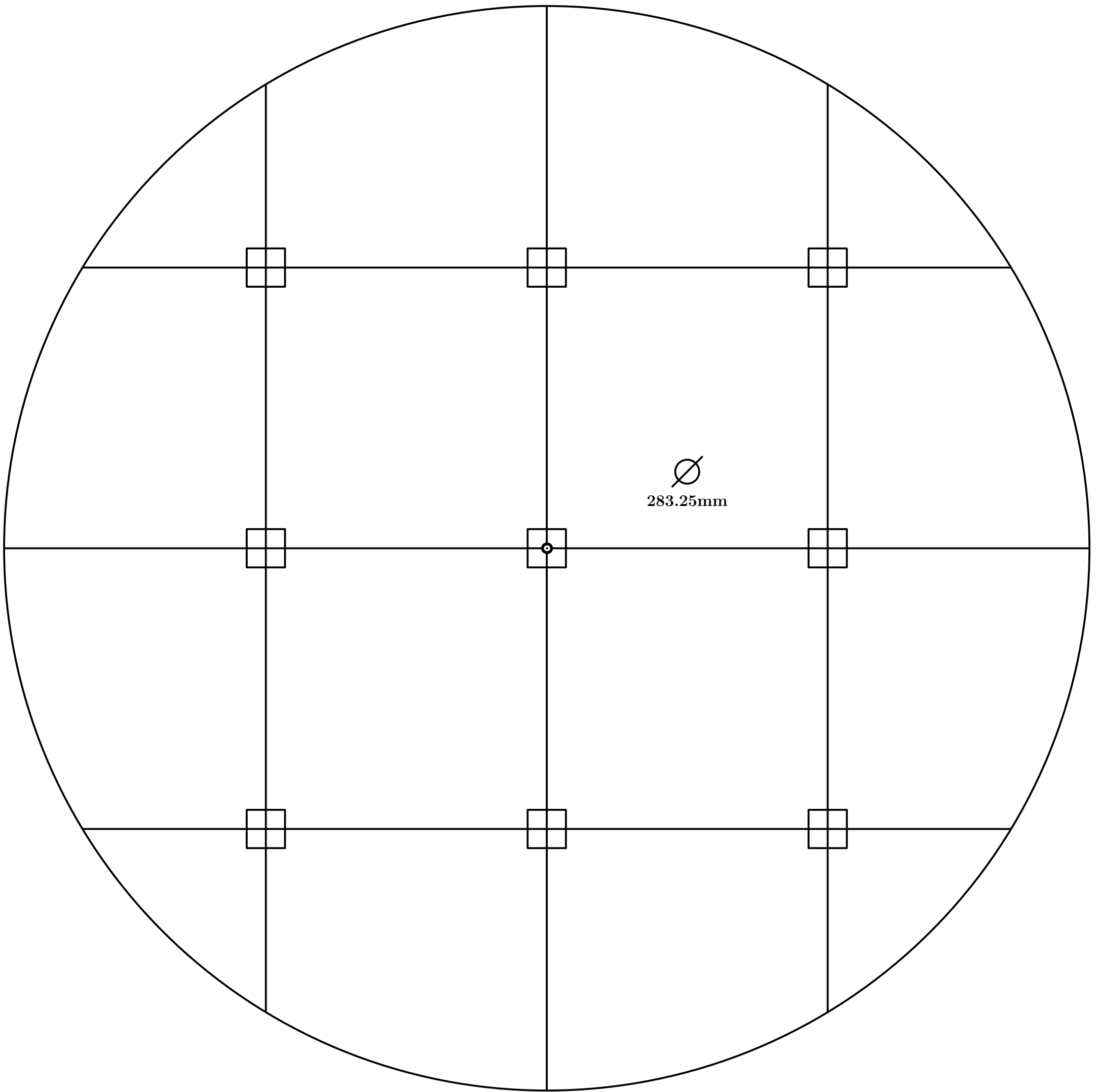

Fig. 734

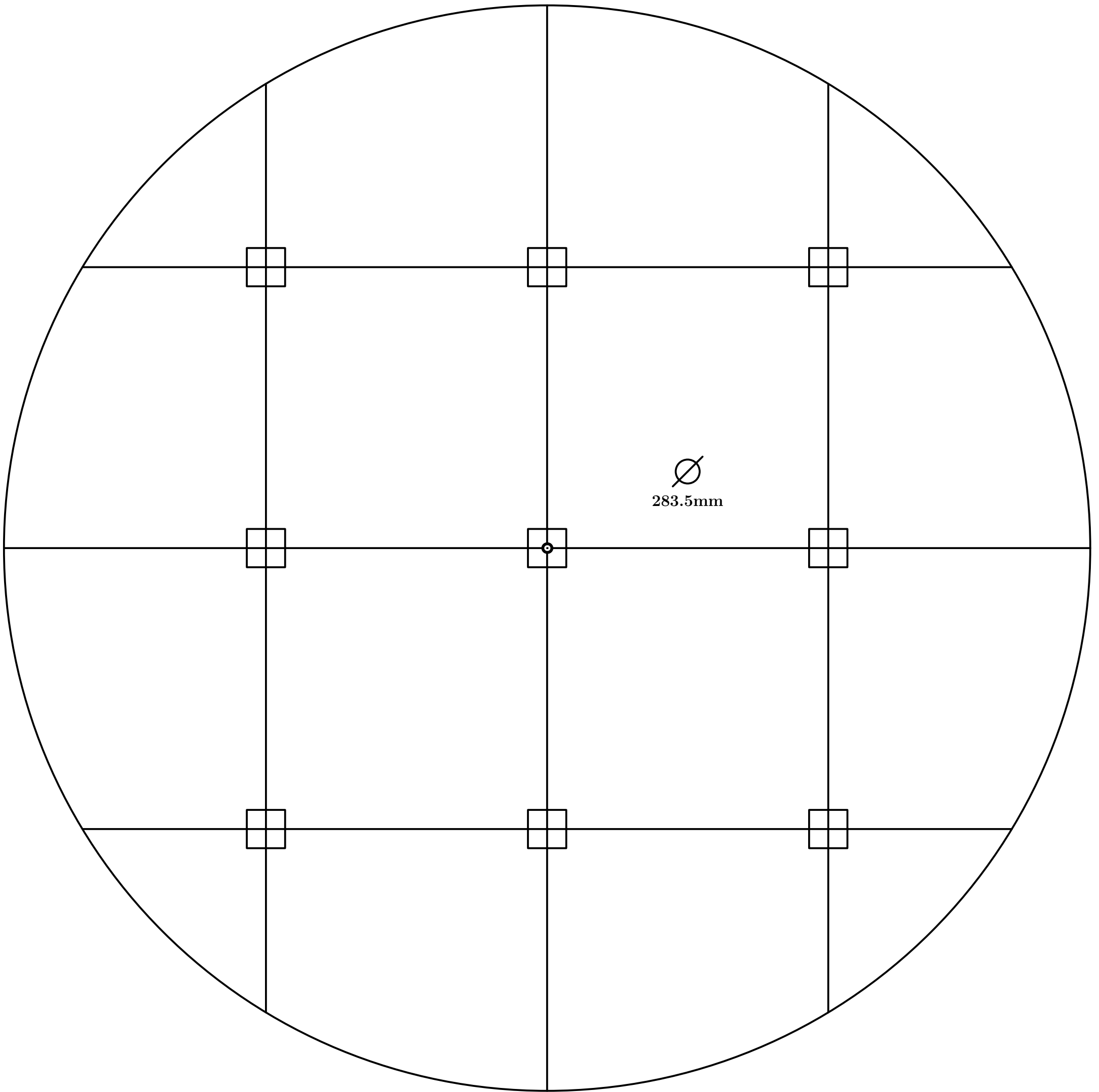

Fig. 735

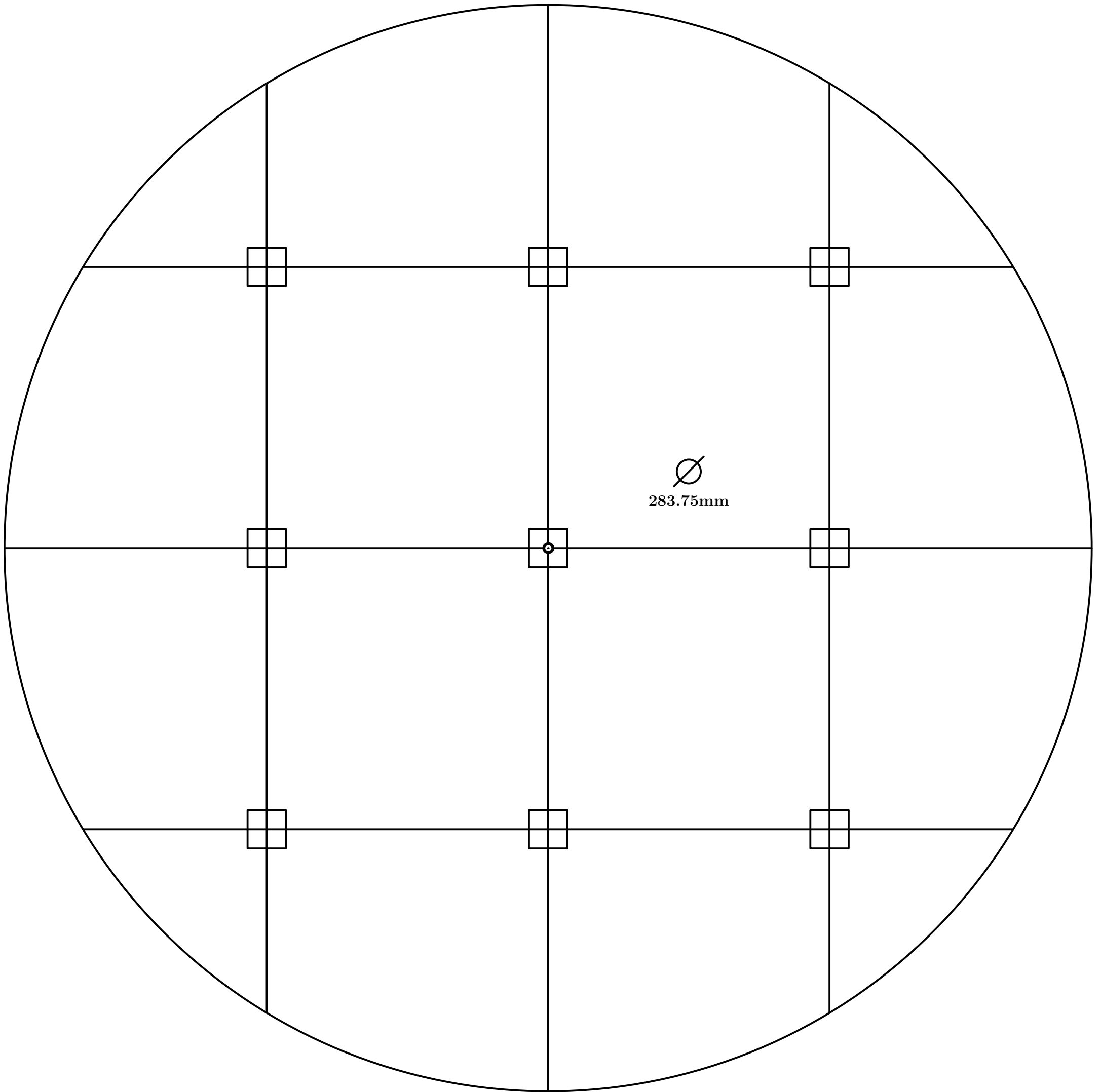

Fig. 736

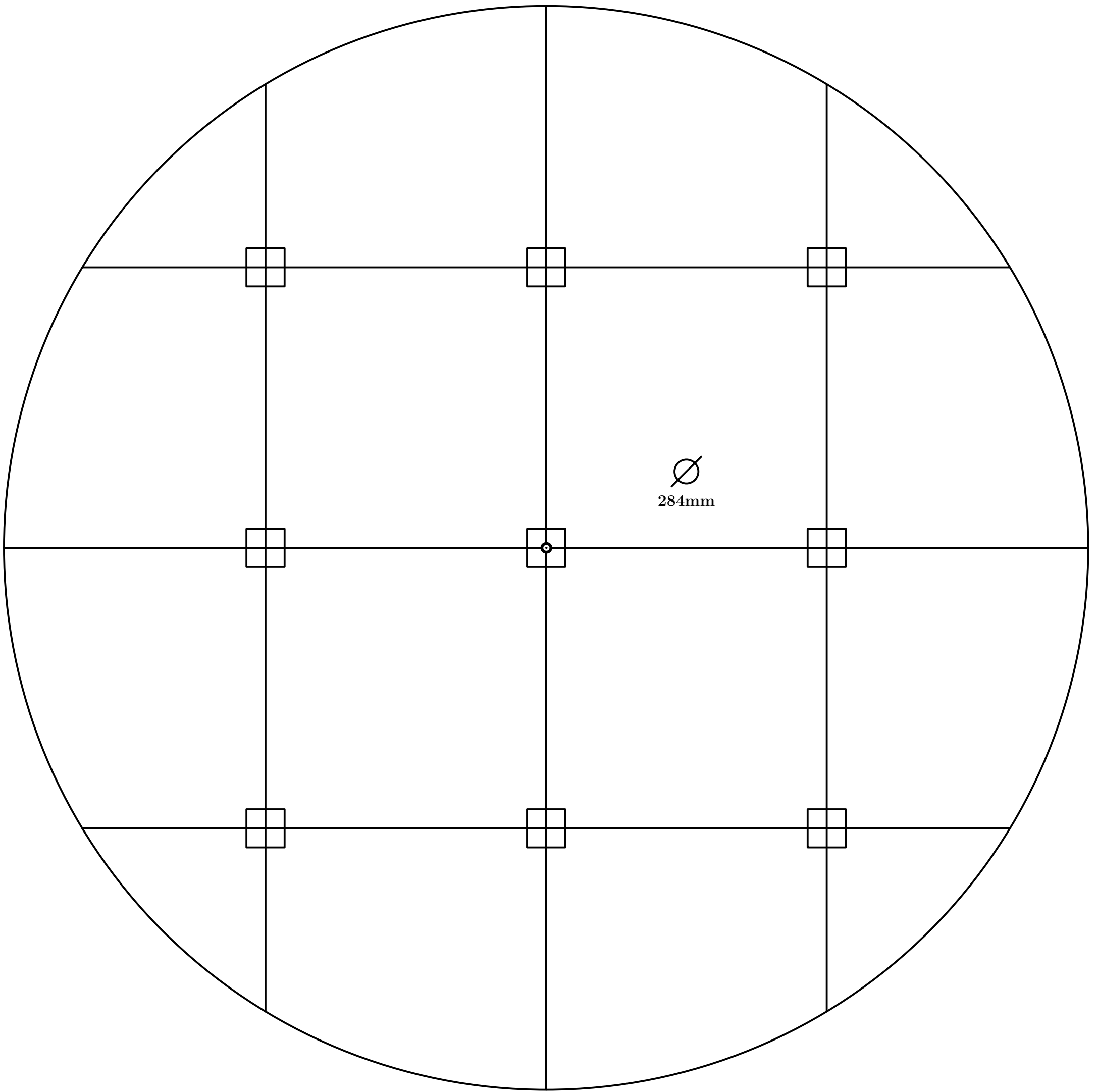

Fig. 737

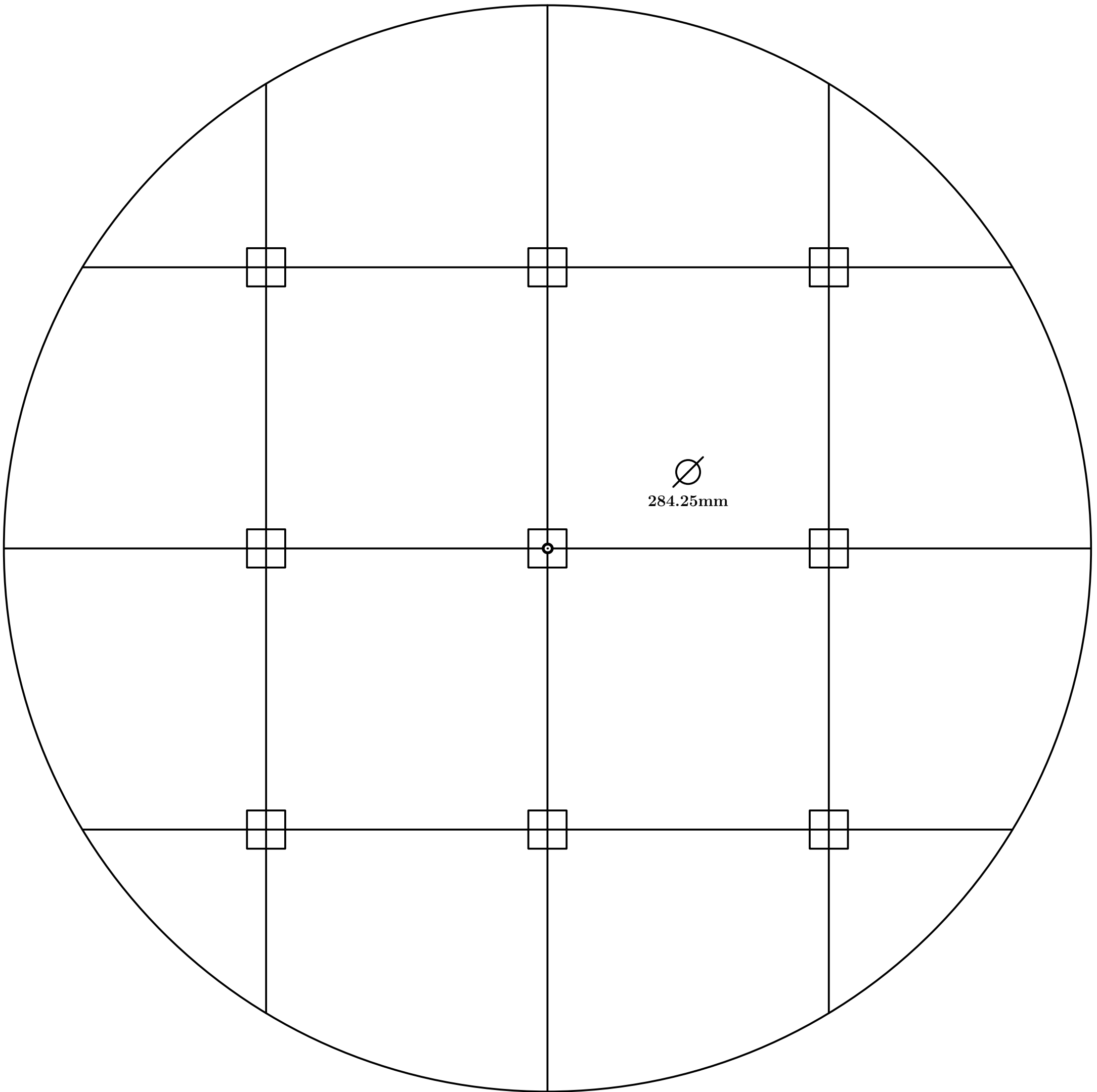

Fig. 738

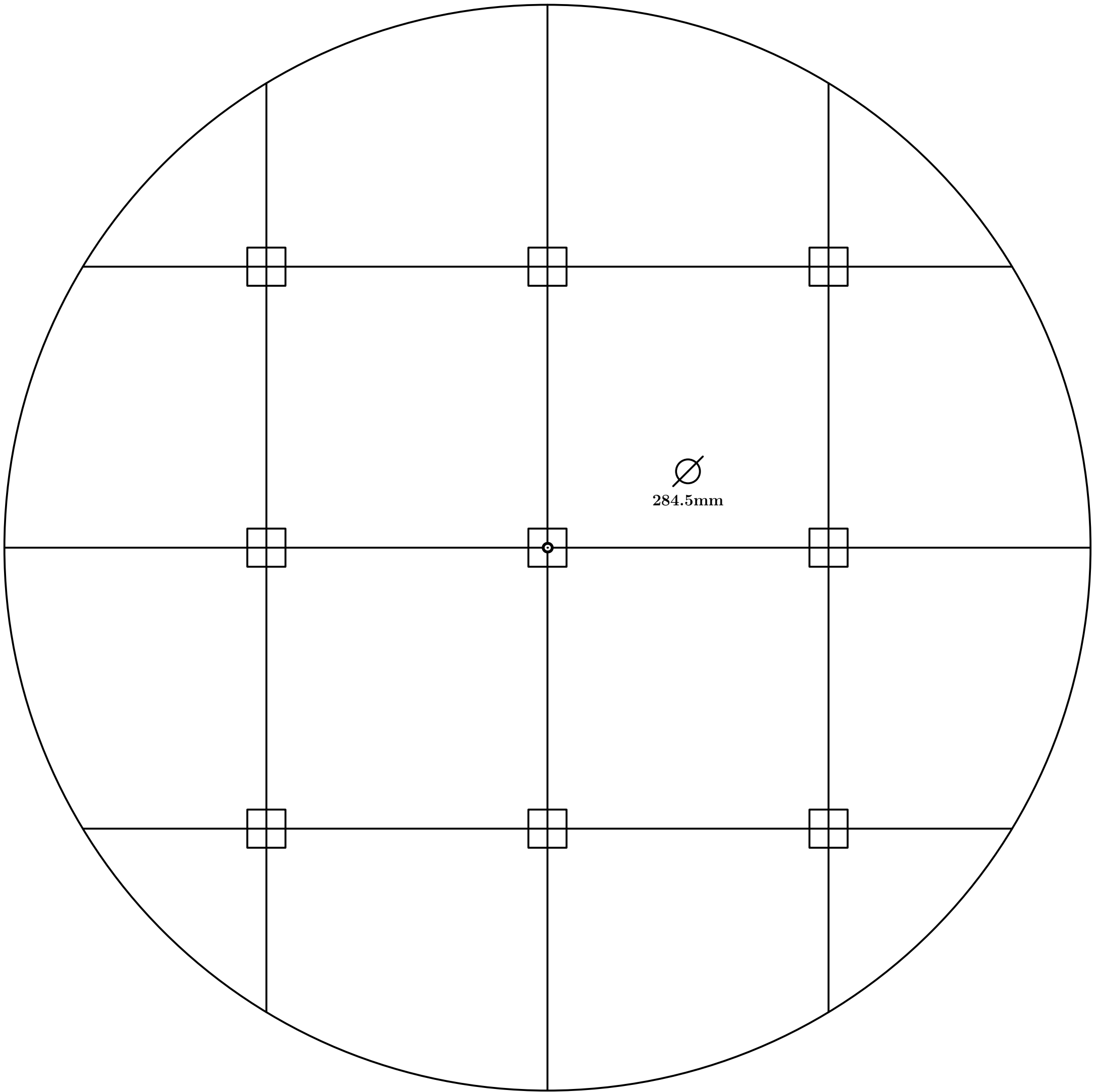

Fig. 739

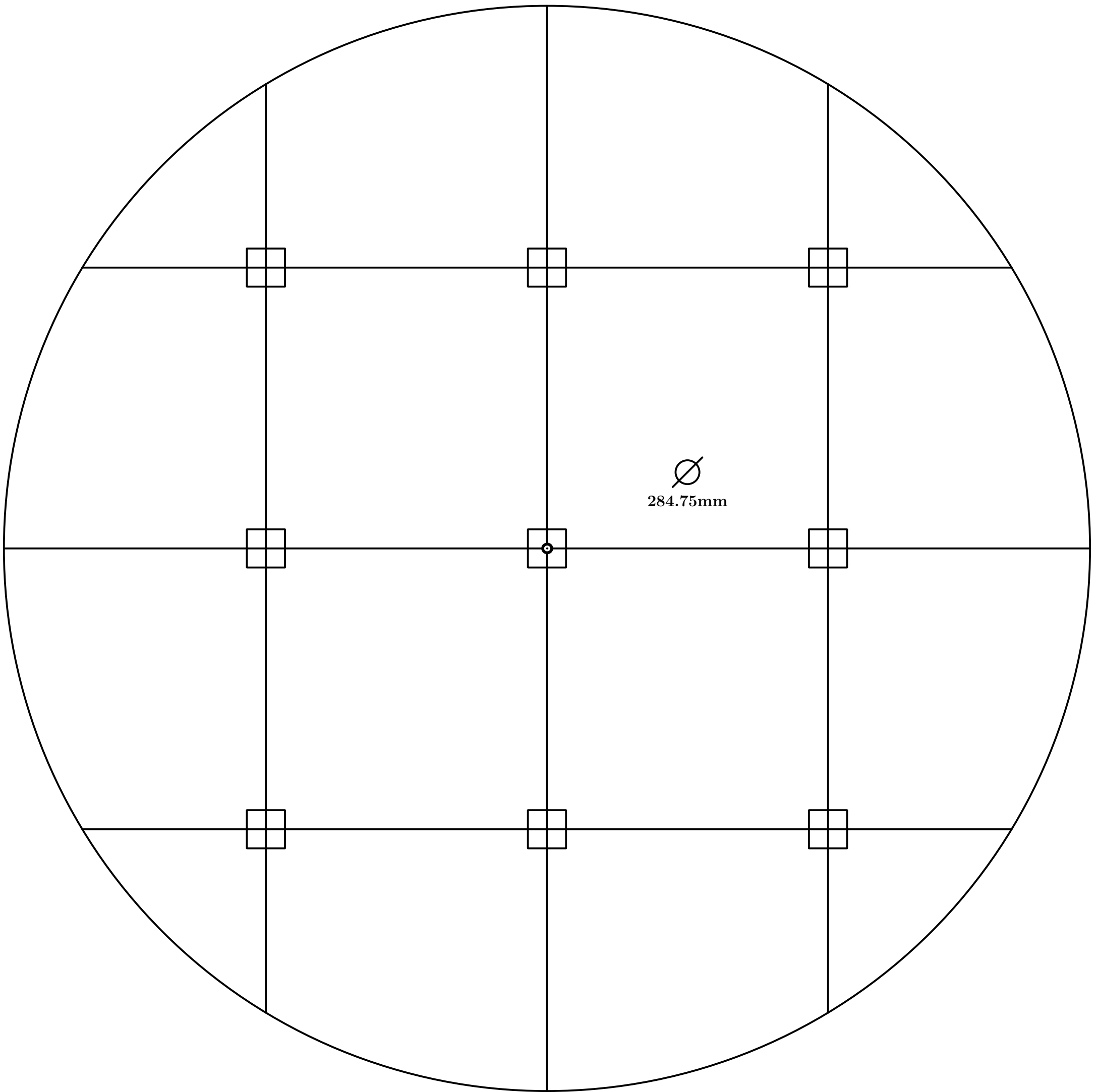

Fig. 740

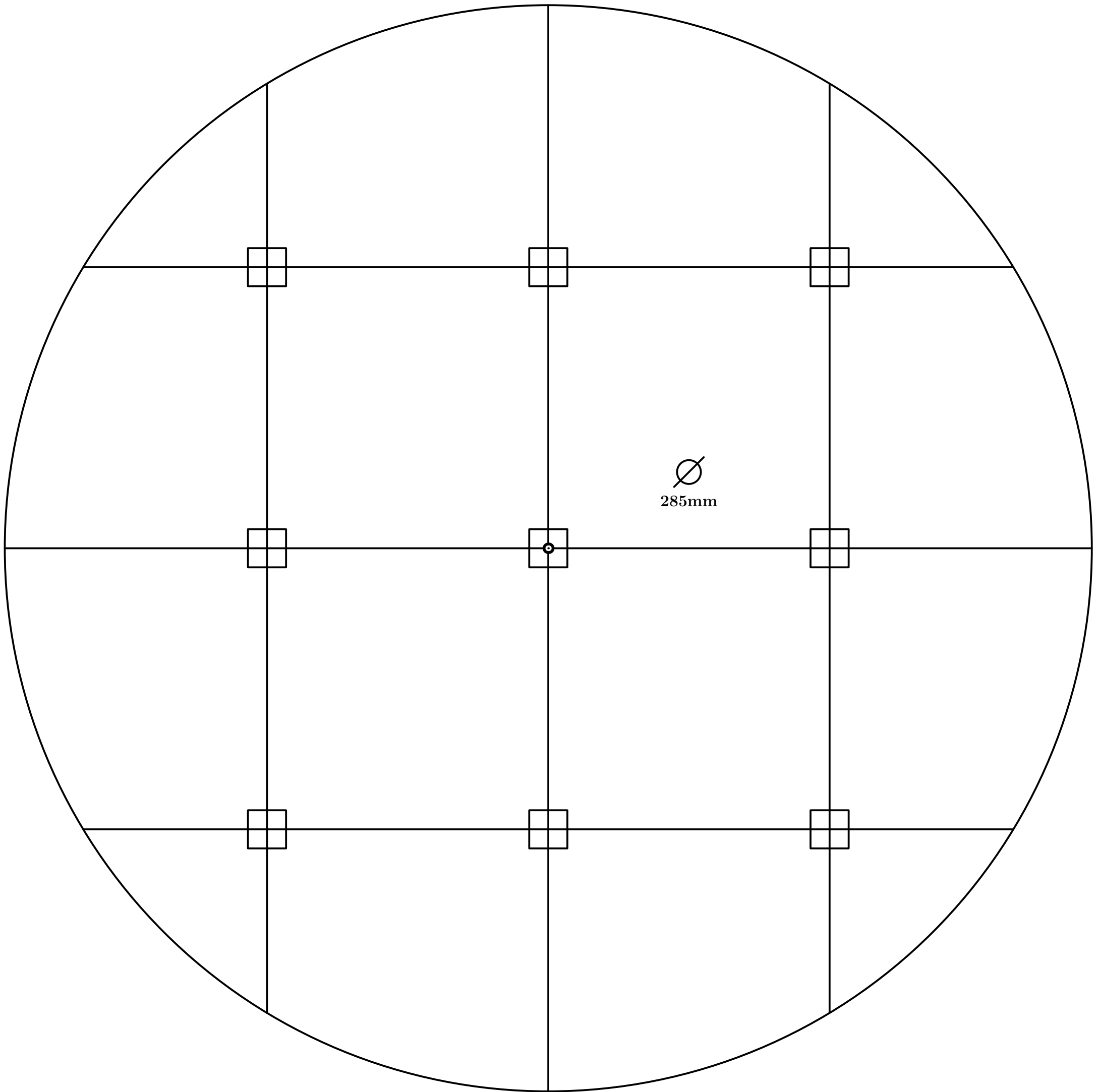

Fig. 741

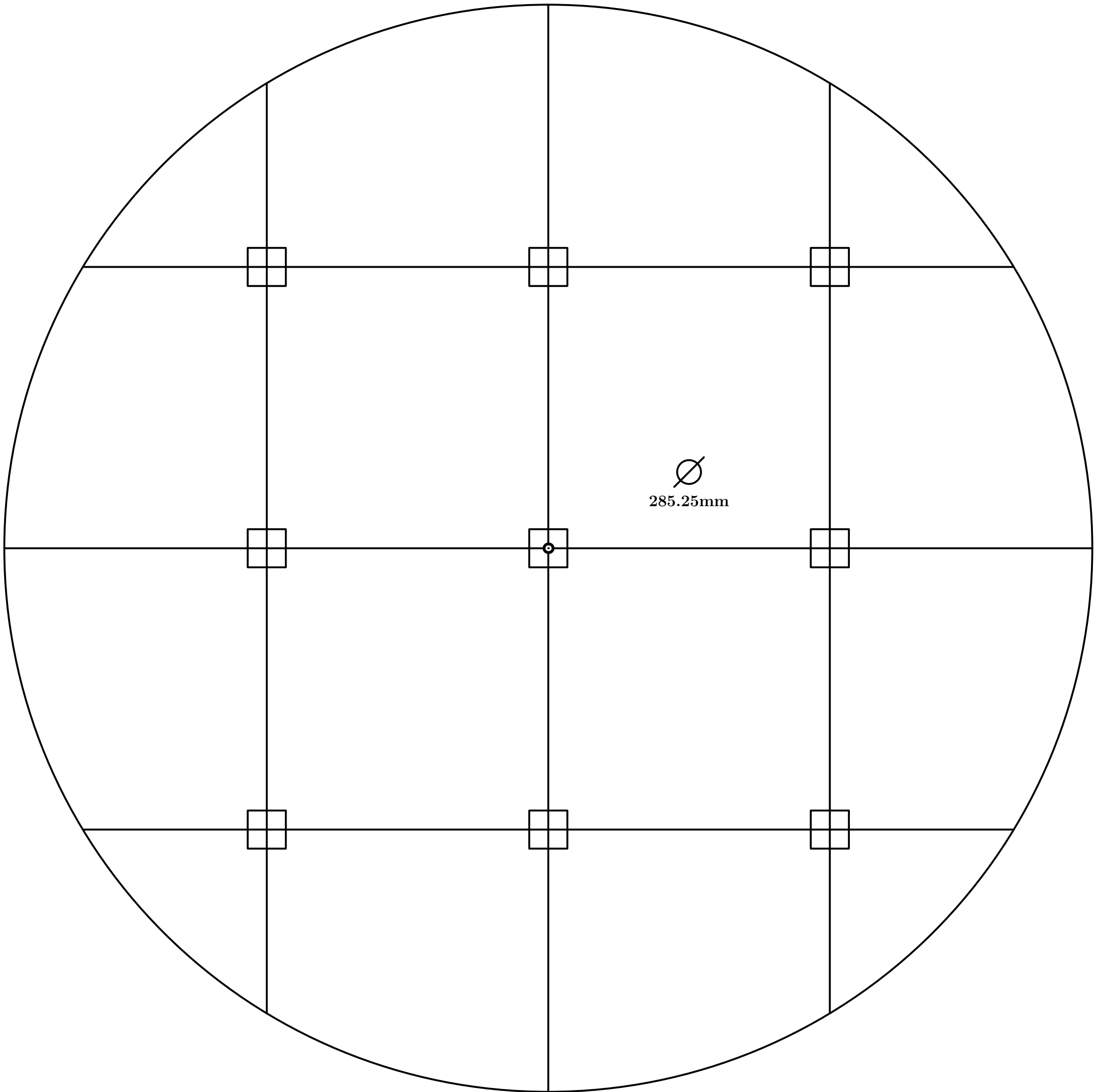

Fig. 742

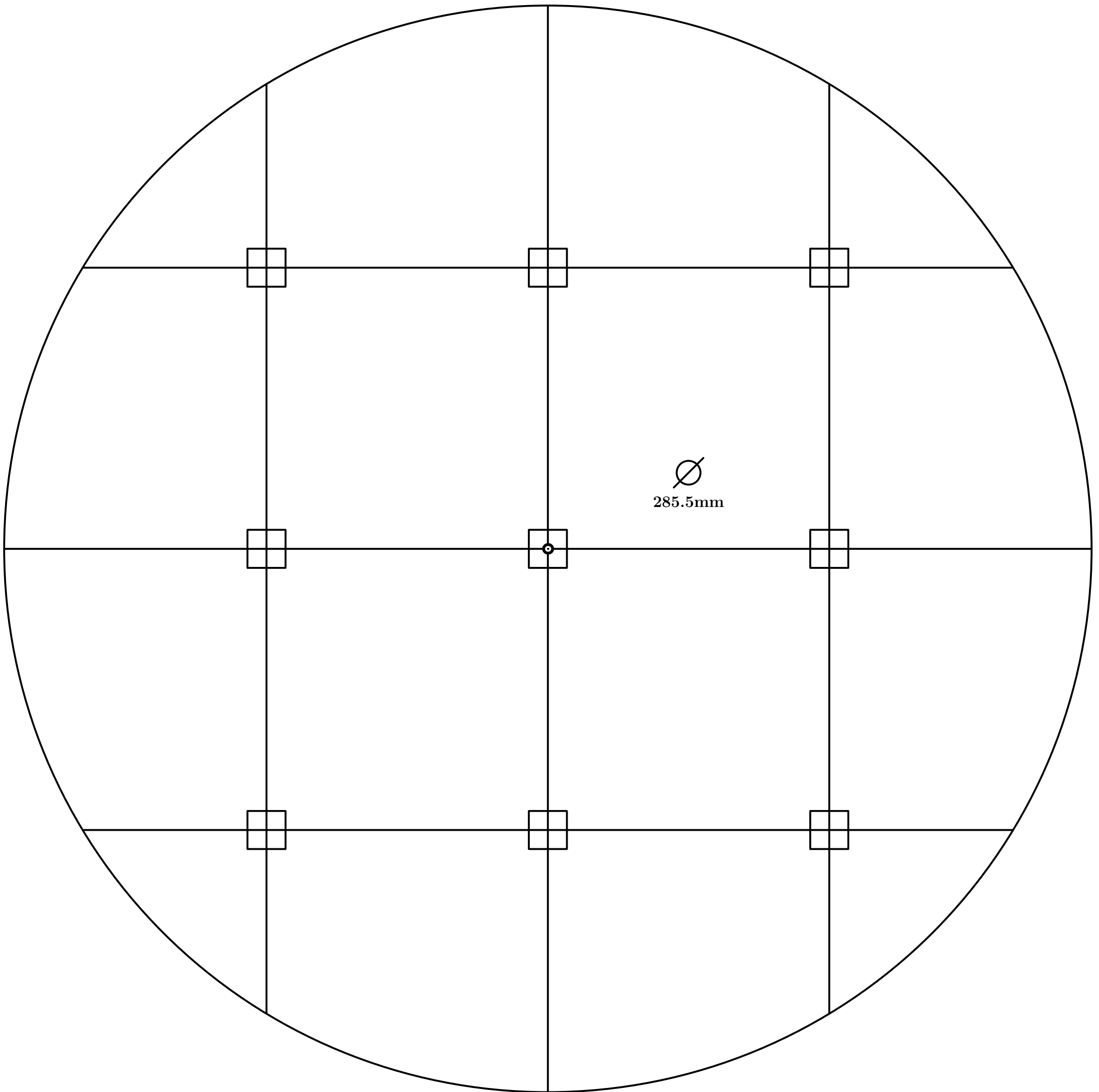

Fig. 743

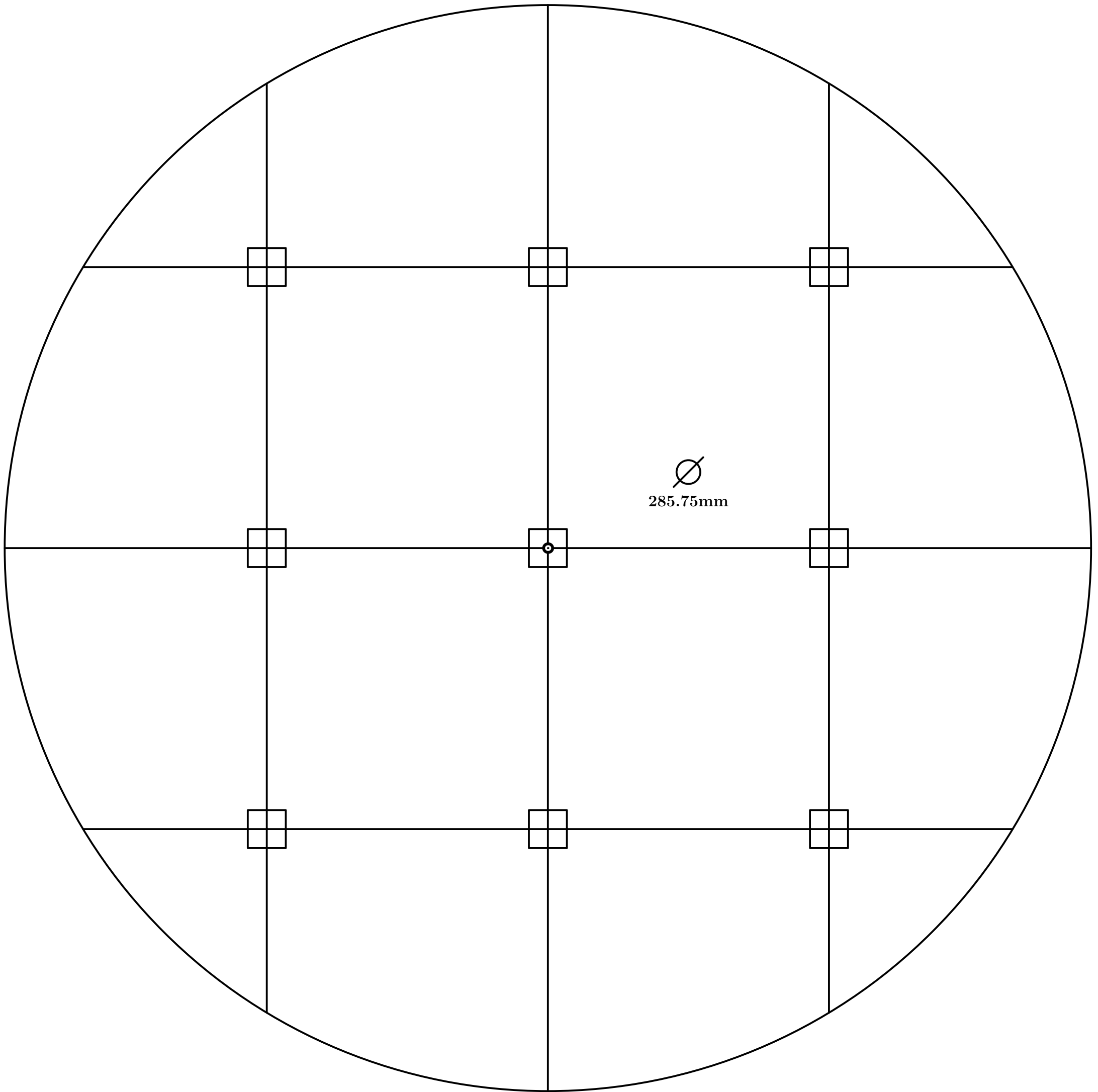

Fig. 744

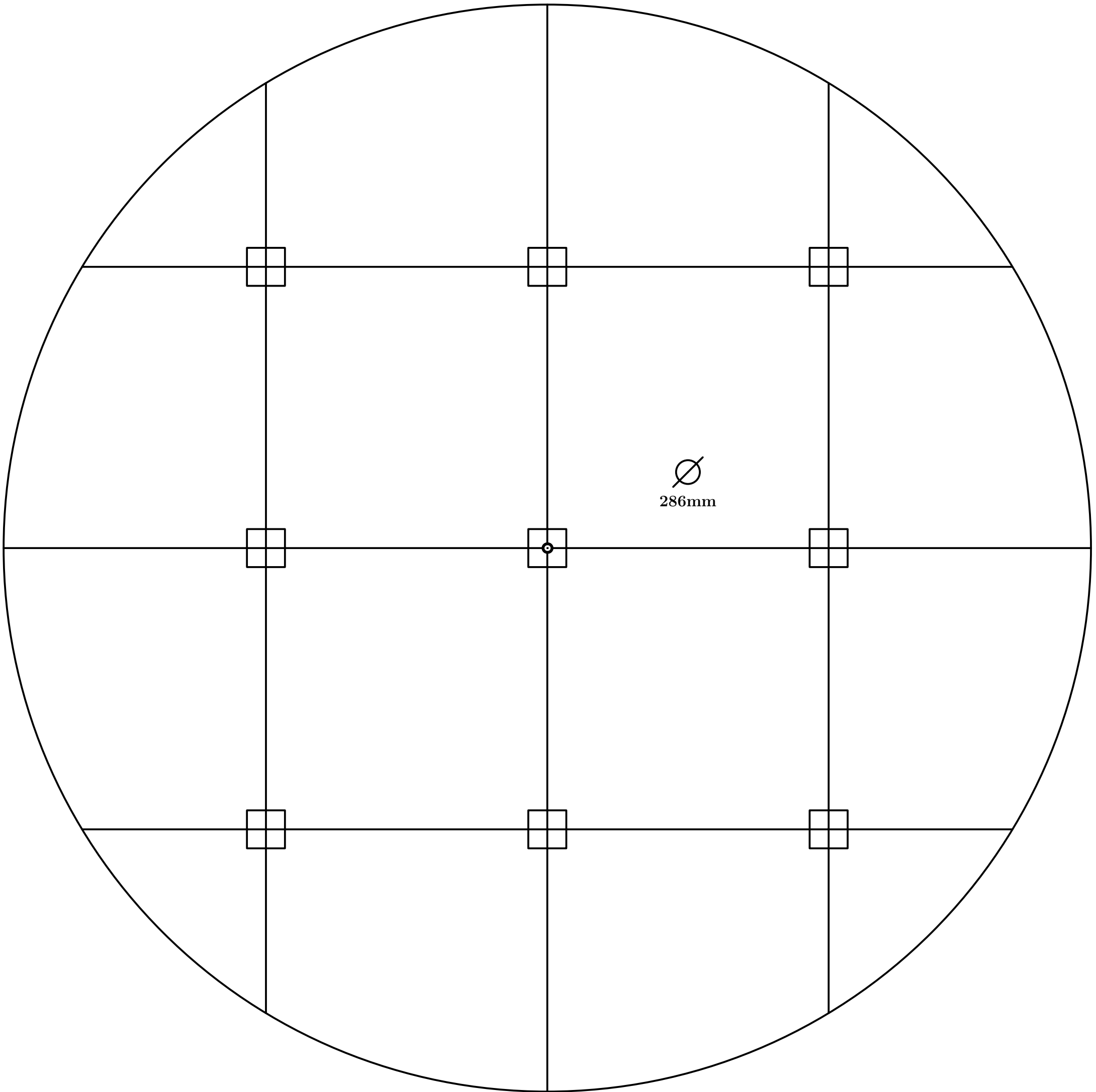

Fig. 745

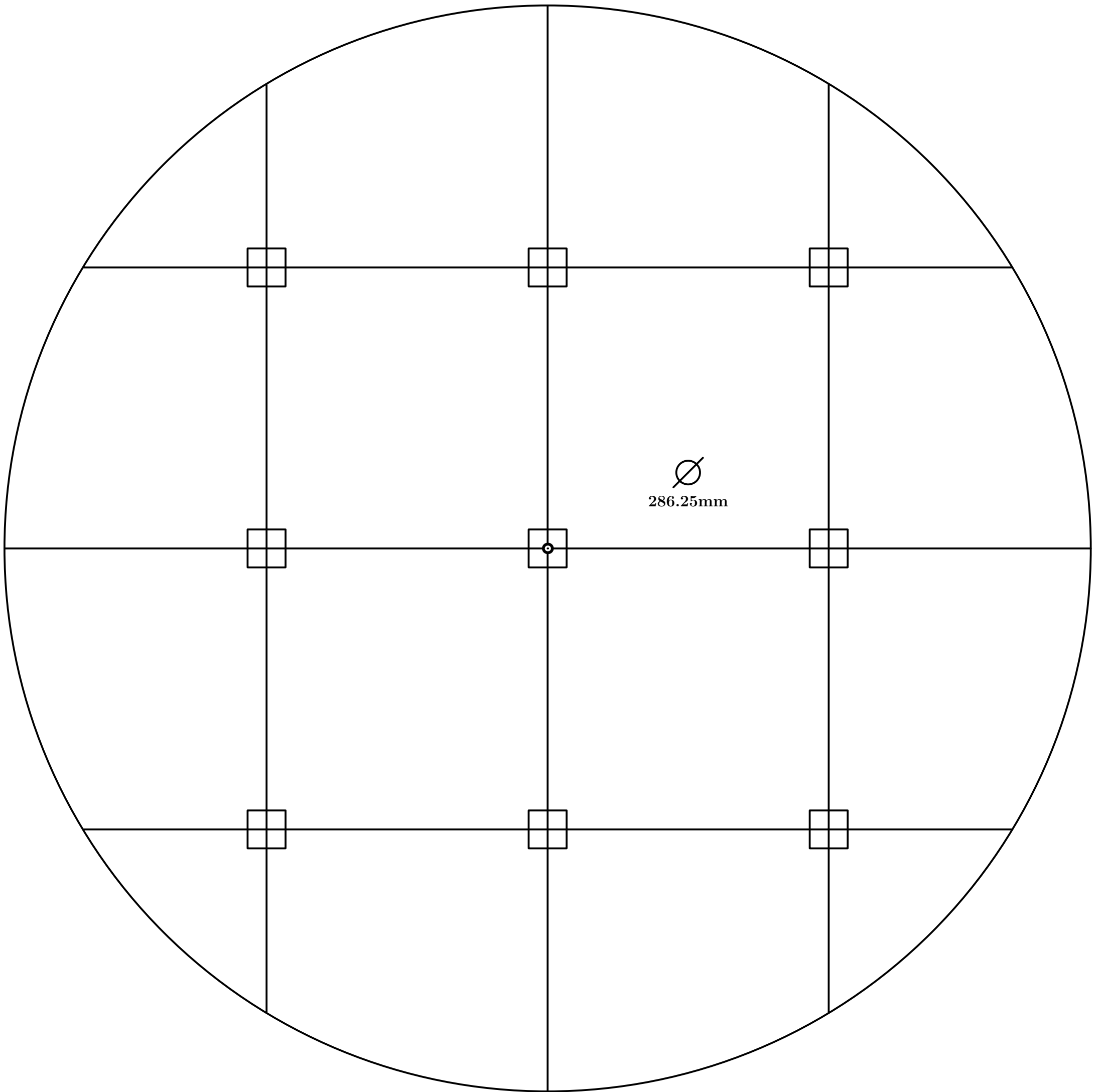

Fig. 746

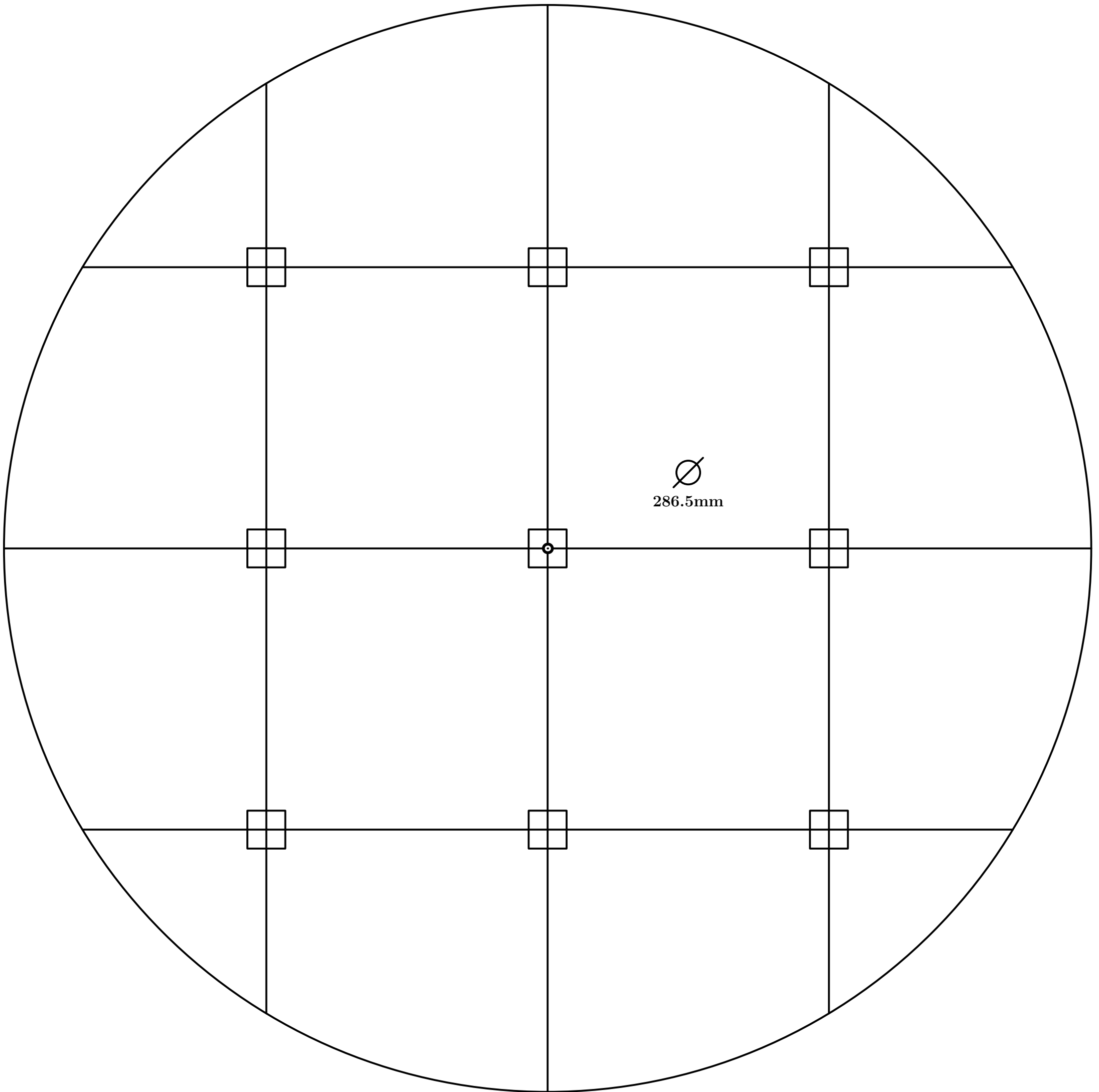

Fig. 747

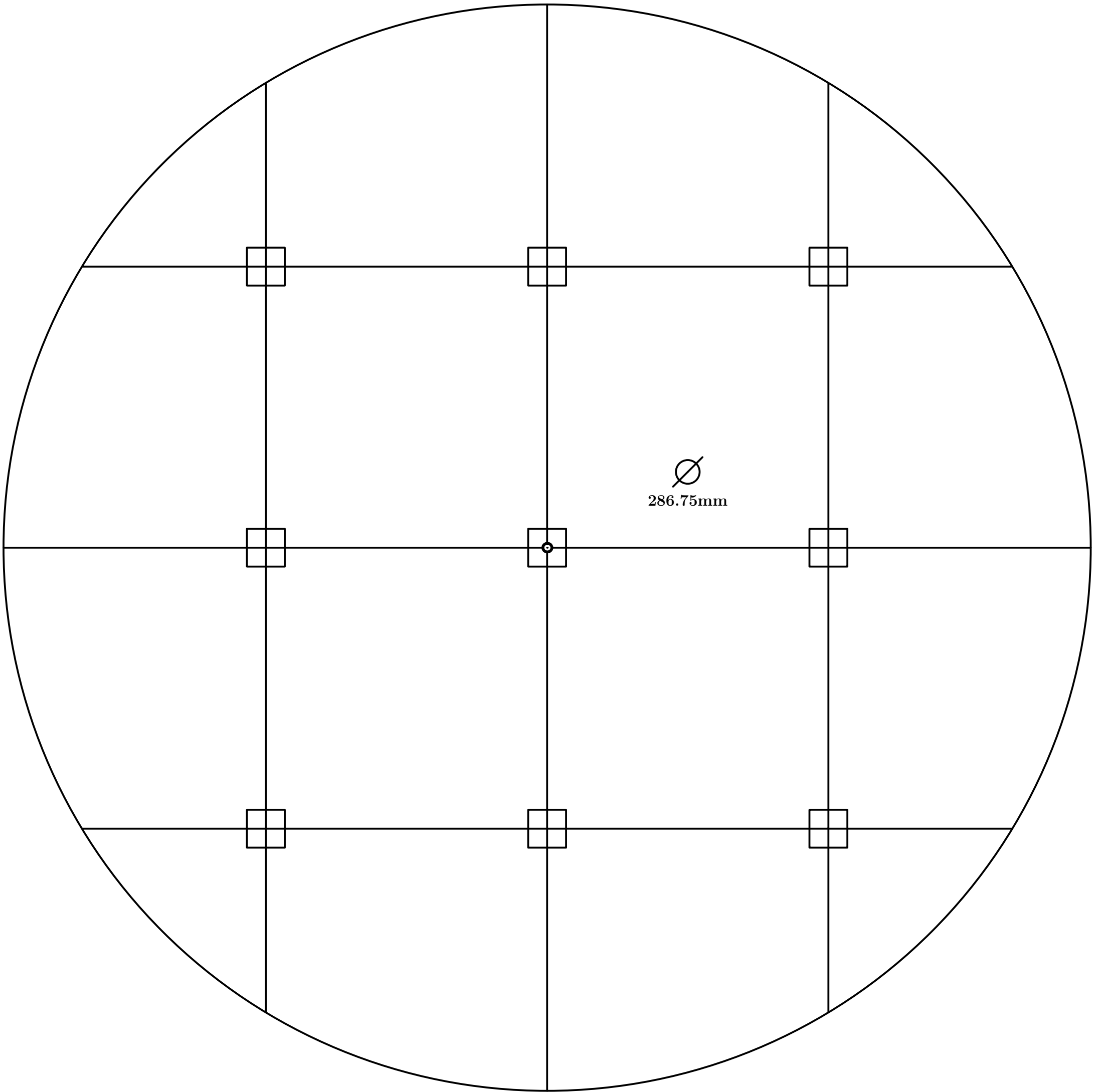

Fig. 748

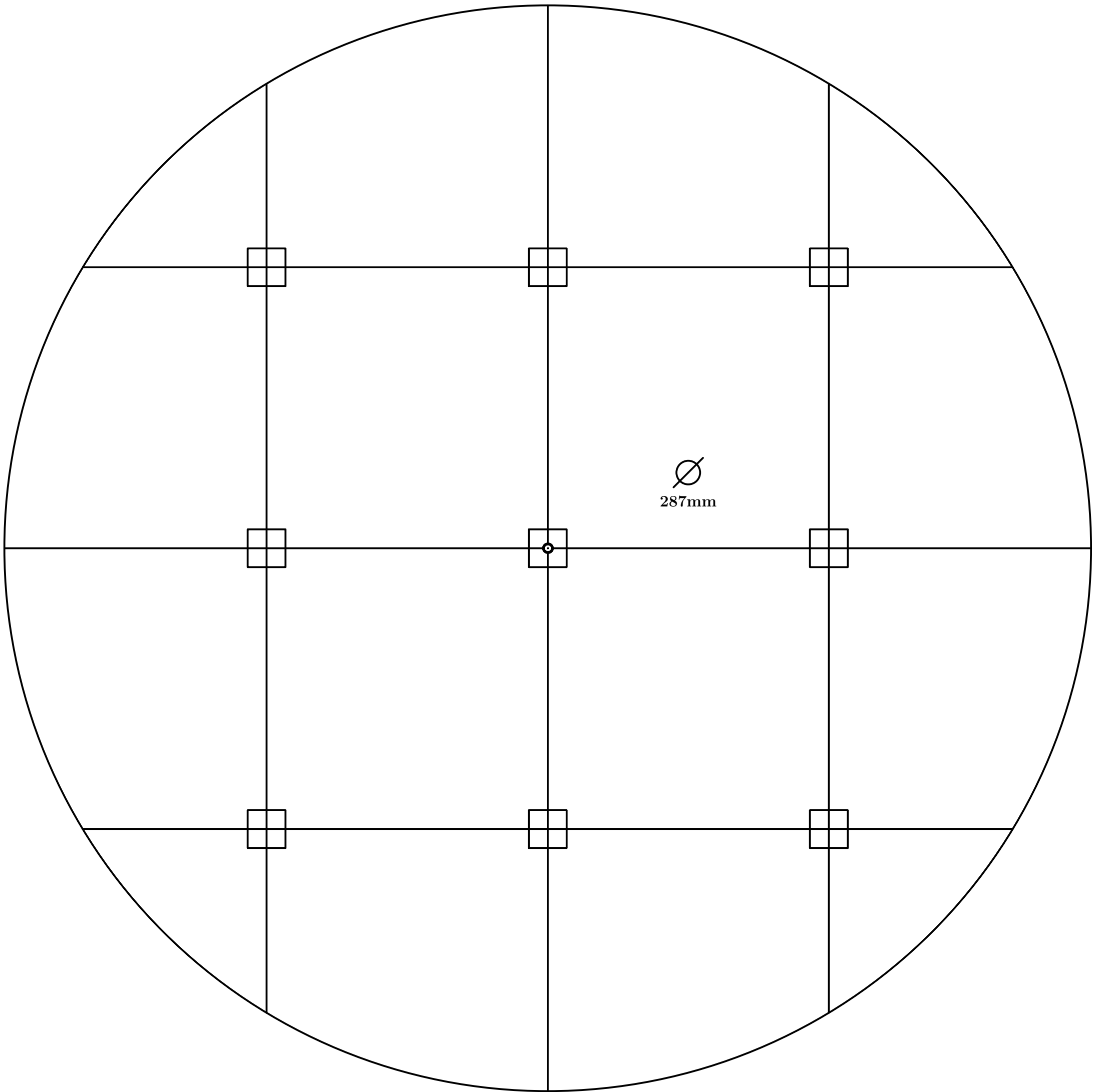

Fig. 749

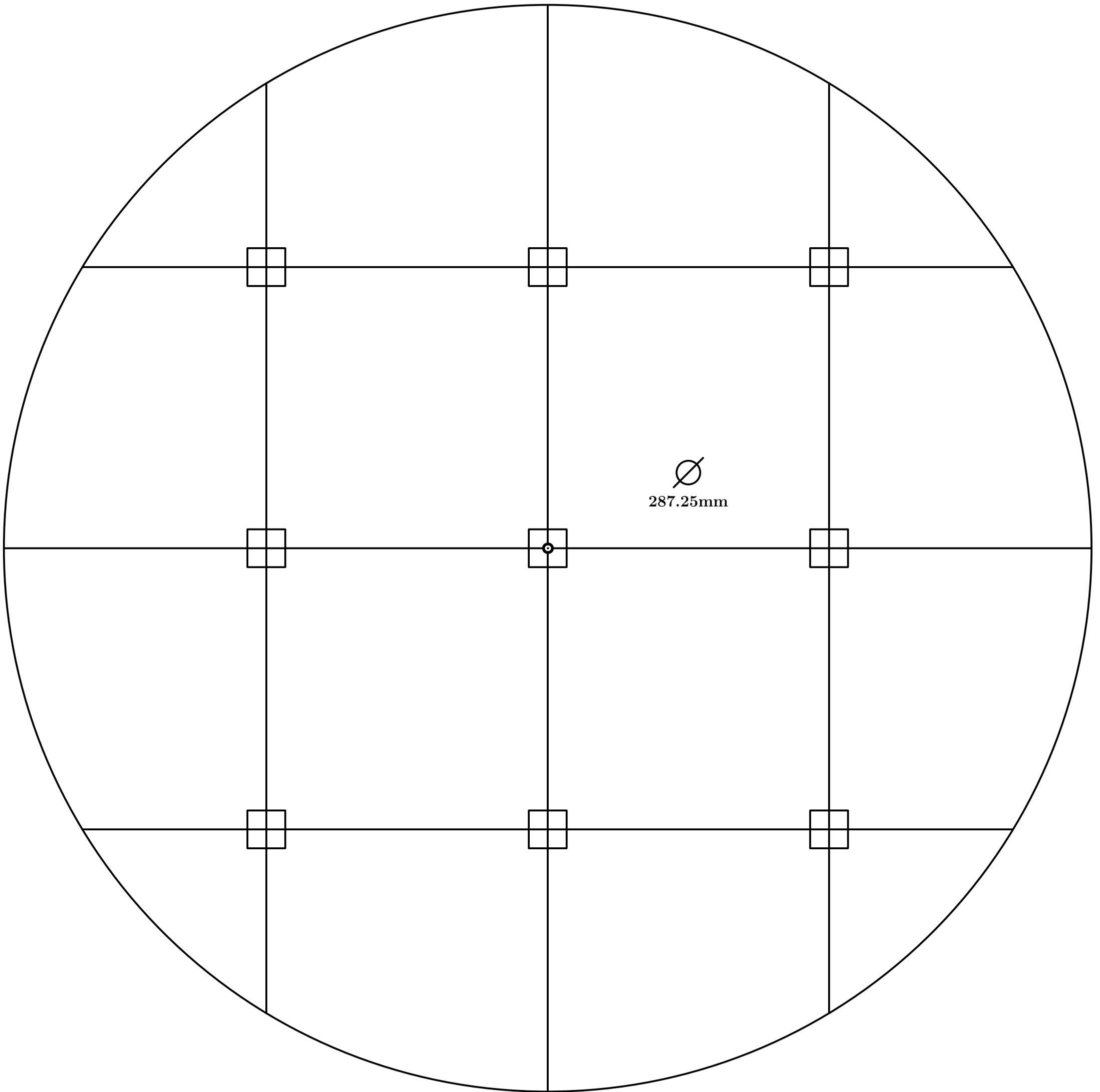

Fig. 750

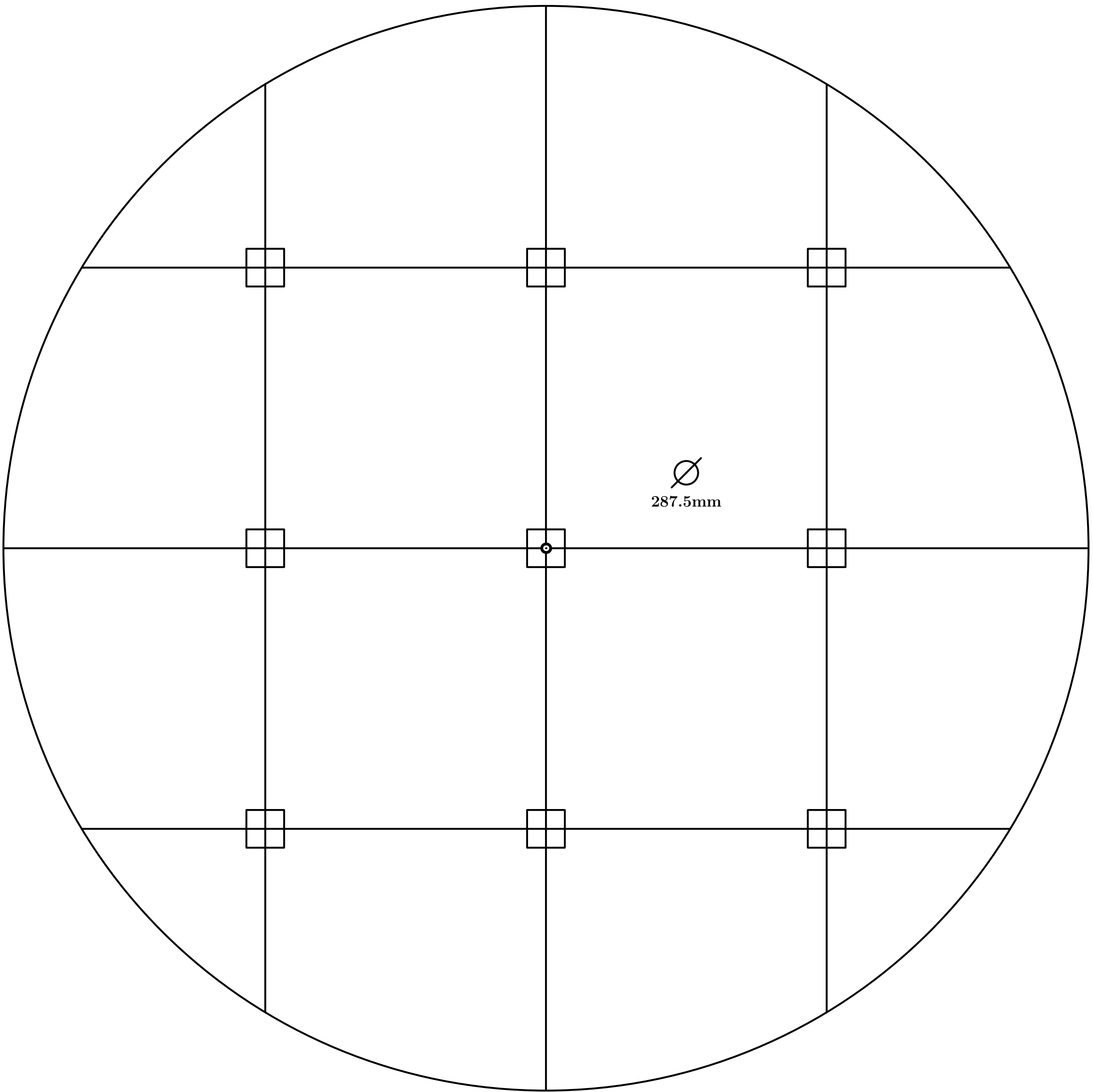

Fig. 751

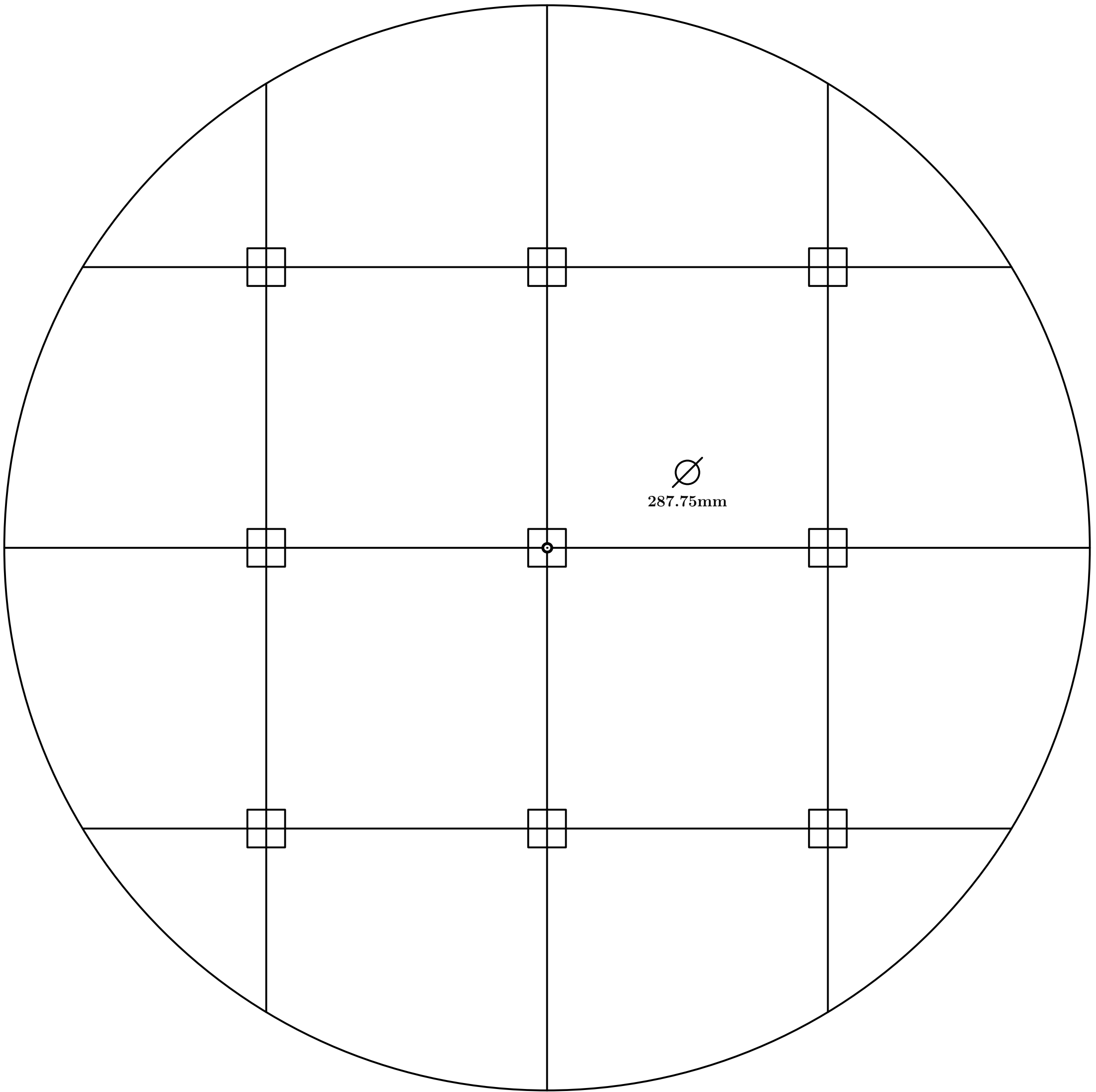

Fig. 752

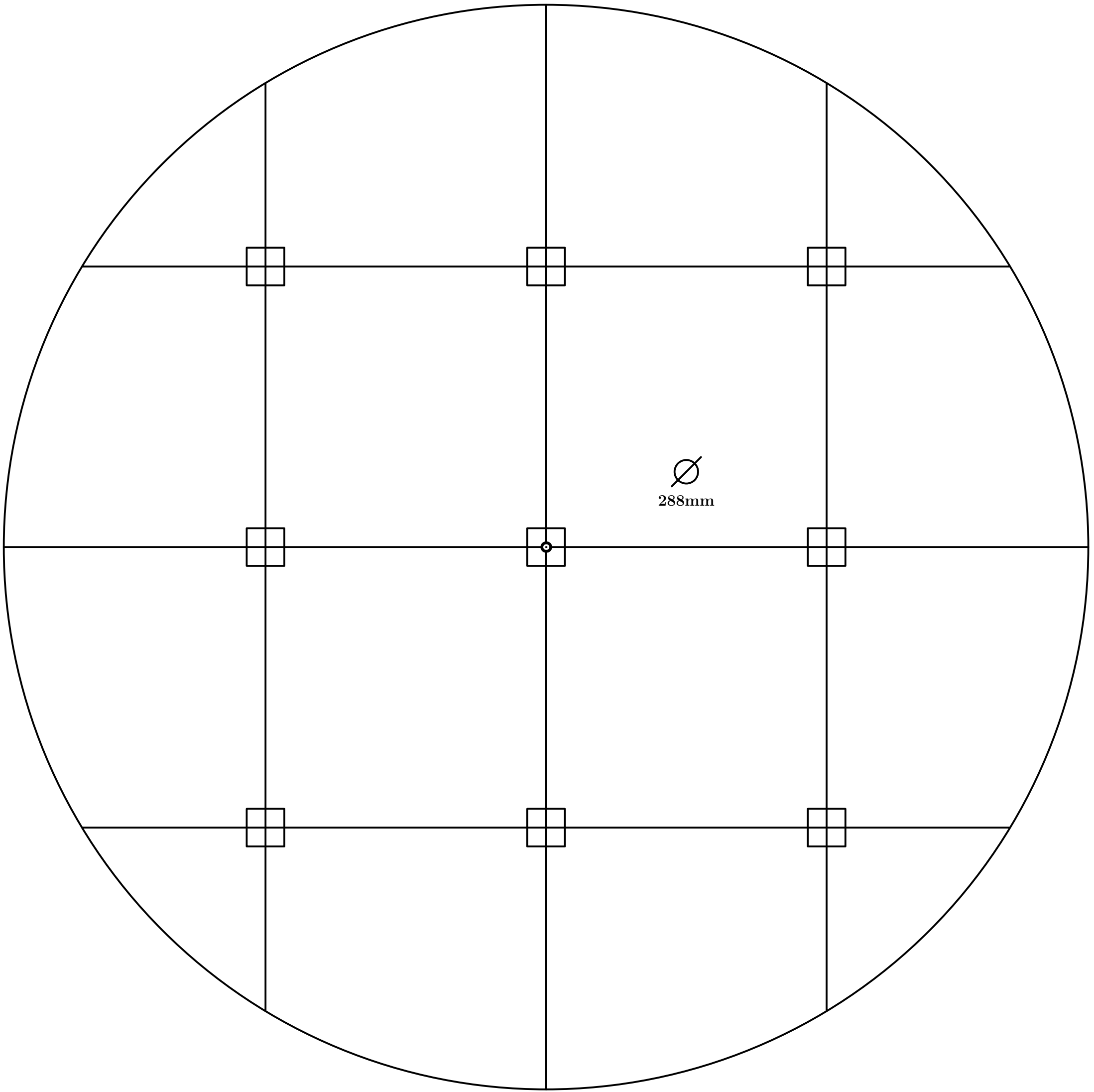

Fig. 753

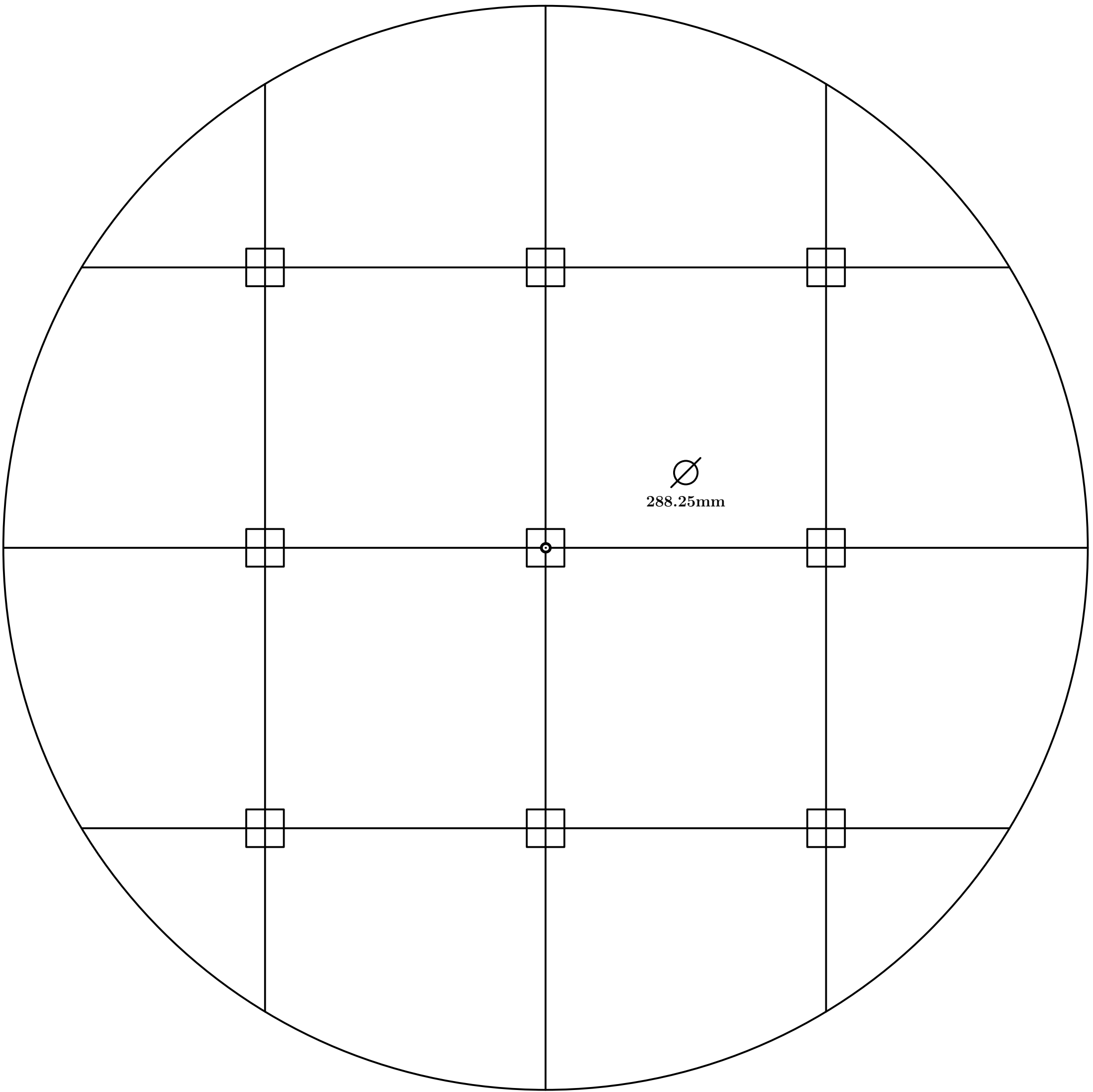

Fig. 754

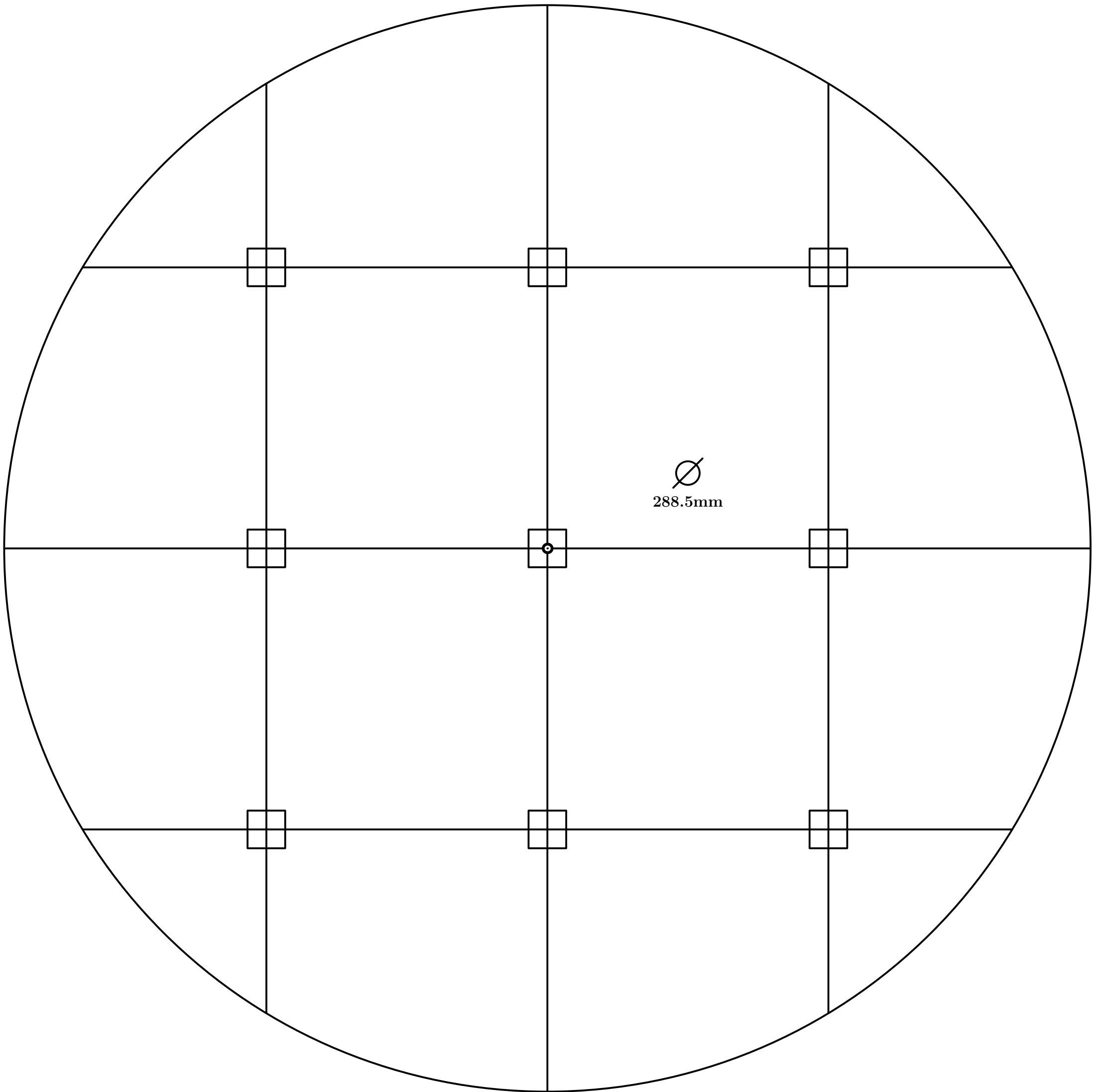

Fig. 755

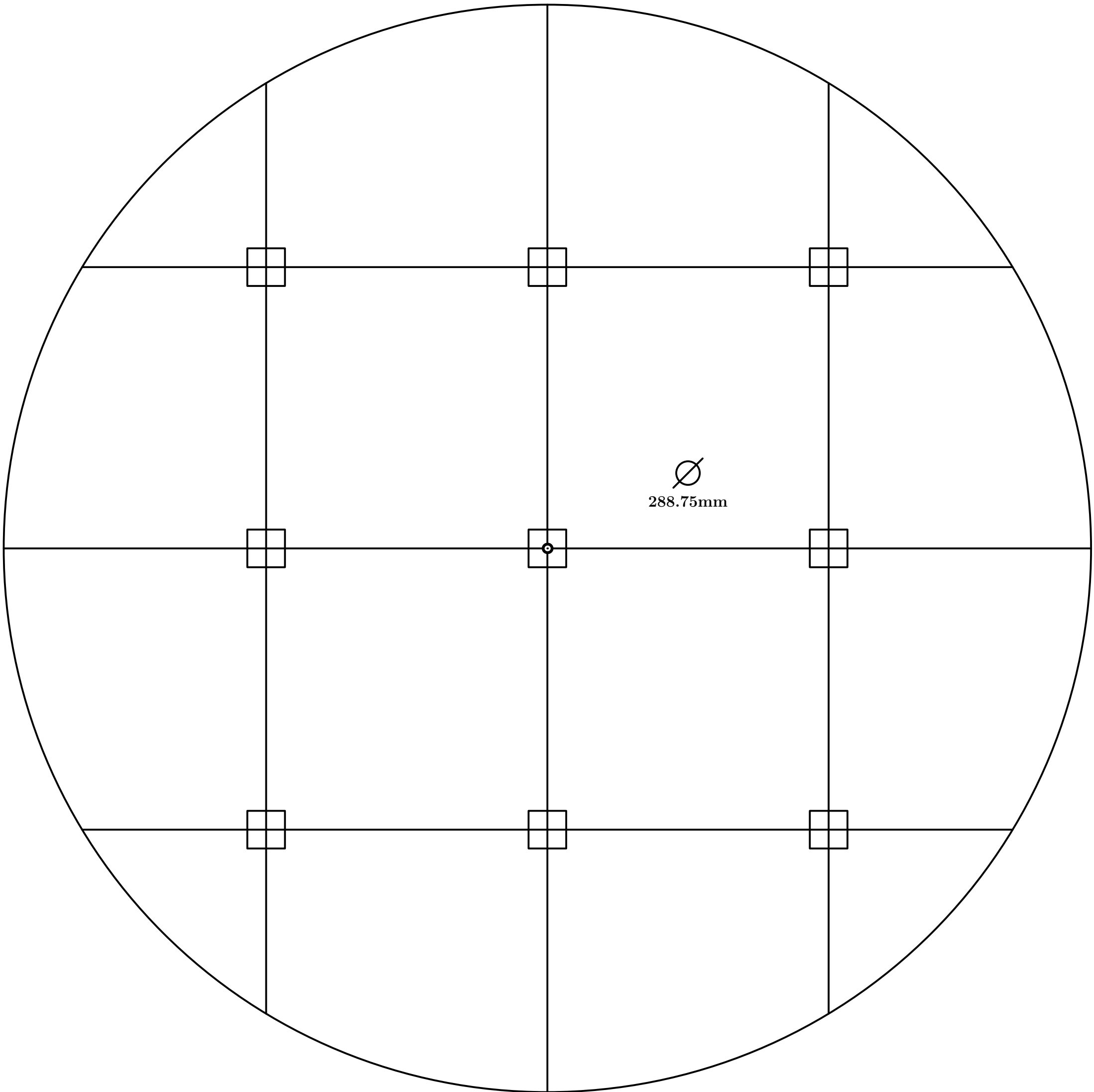

Fig. 756

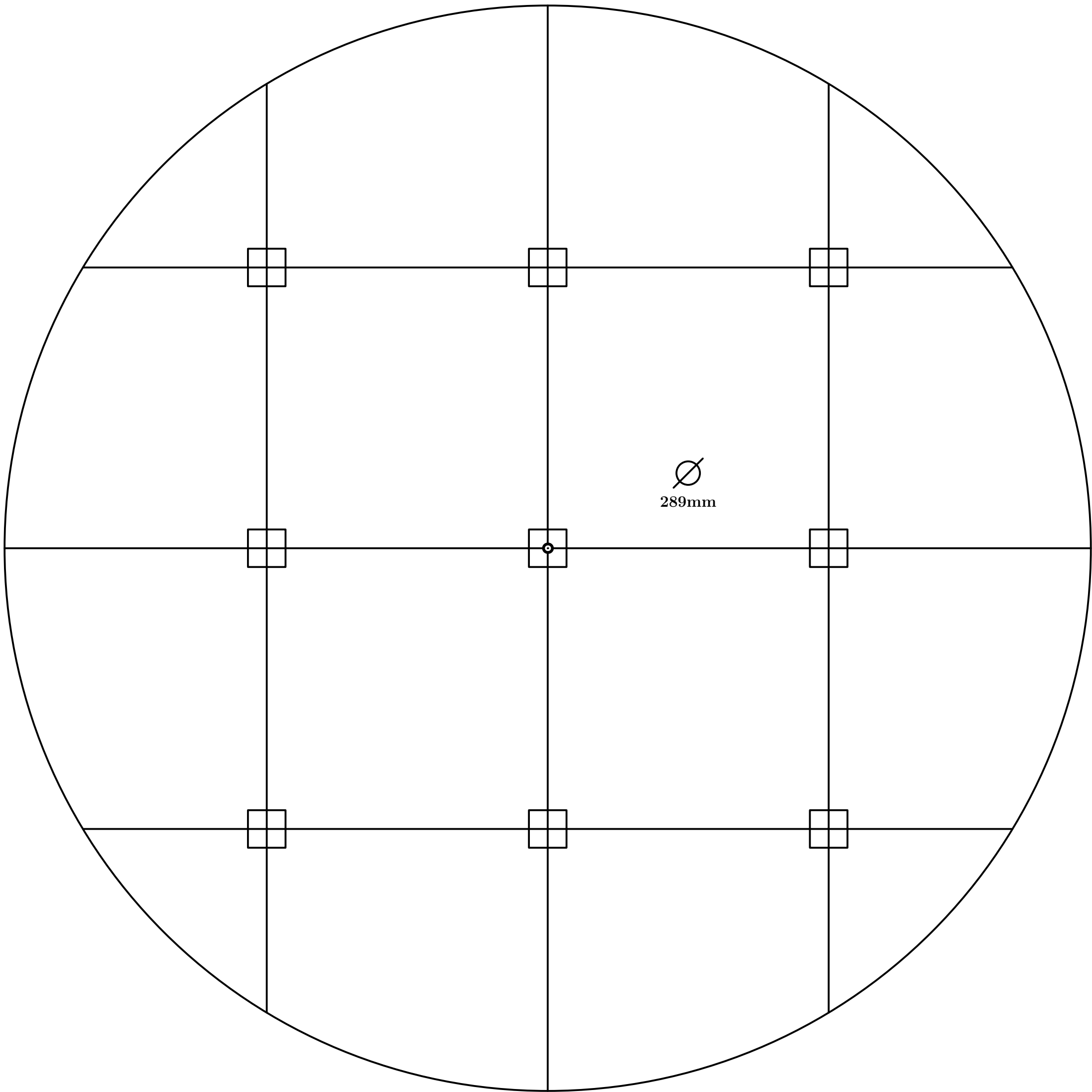

Fig. 757

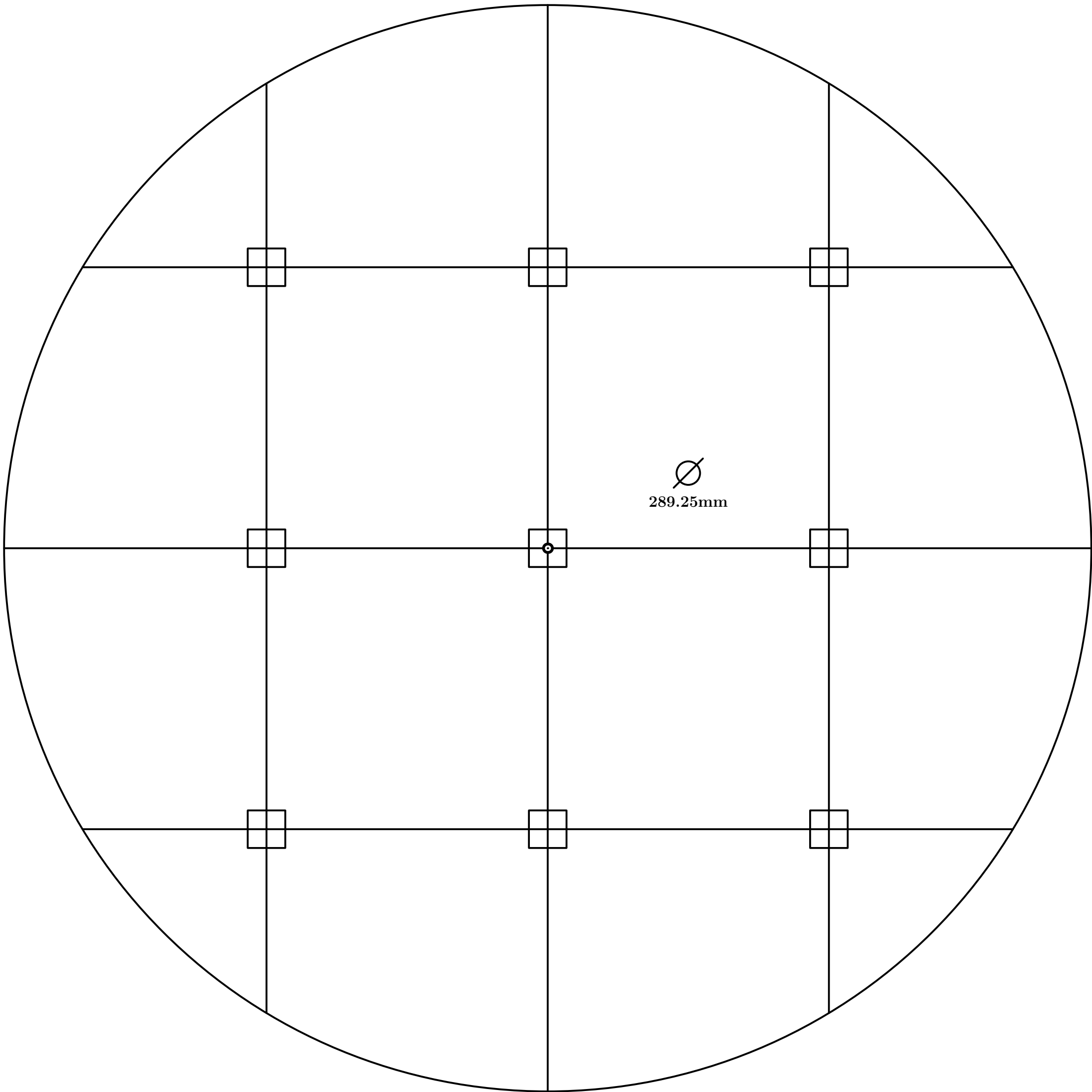

Fig. 758

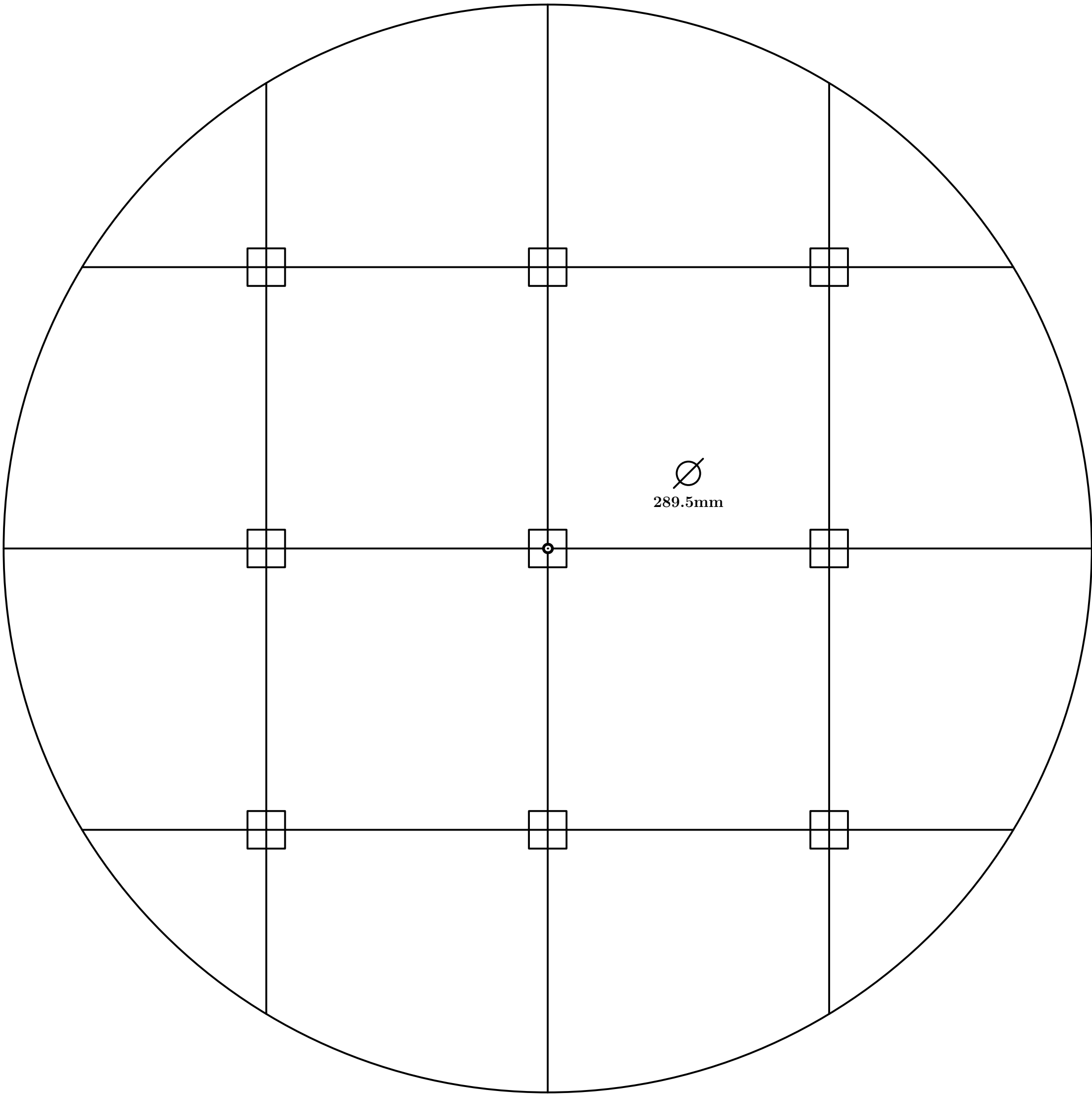

Fig. 759

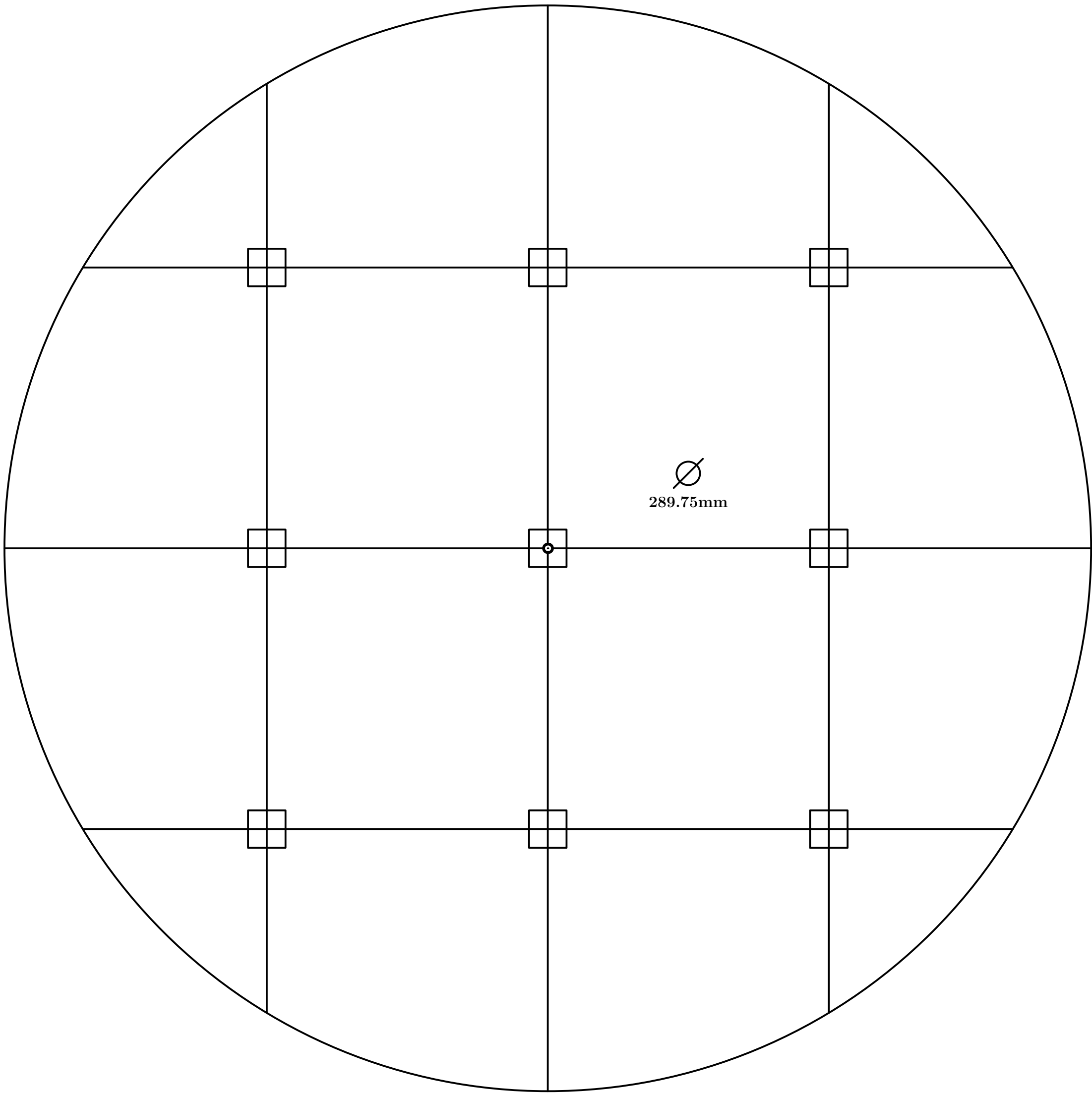

Fig. 760

